

Product Description

The BSW6321 is a reflective SPDT RF switch that can be used in high power and good performance WLAN 802.11 a/b/g/n/ac/ax, DOCSIS 3.0/3.1 and Wireless Communication applications.

This device is packaged in RoHS2-compliant with 1.5mmx1.5mmx0.5mm, 6-lead UDFN package. It must be used with back side ground soldering.

The BSW6321 has robust ESD protection circuits at all pins and temperature performance (operating temperature range : -40 to +105°C).

This switch does not require blocking capacitors. If DC is presented at the RF port, add a blocking capacitor. This device also has a high linearity performance over all temperature range such as IIP3, IIP2.

A functional block diagram is shown in Figure 1.

Block Diagram

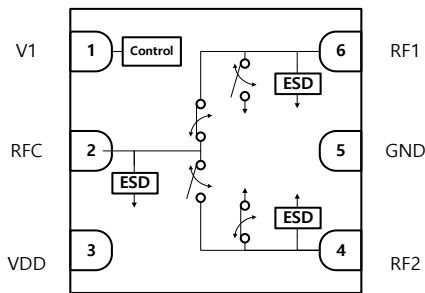
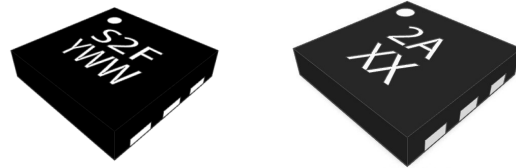

Figure 1 Functional Block Diagram

Applications

- WiMAX 802.16
- WLAN 802.11 a/b/g/n/ac/ax
- DOCSIS 3.0/3.1
- Drone
- Bluetooth
- Wireless Infrastructure
- Remote keyless entry
- Telematics / Infotainment
- Two-way radios
- Wireless control systems
- GPS/Navigation

Package Type



6-Lead 1.5mmx1.5mmx0.5mm, UDFN Package

Figure 2 Package Type

Device Features

- Output frequency range : 5 MHz to 6.0 GHz
- Fast Switching Time : 105 to 145 ns
- Supply Voltage : 2.7V to 5.0V
- Low insertion loss
 - : 0.55dB @ 2.45GHz
 - : 0.69dB @ 5.75GHz
- High isolation
 - : 42dB @ 2.45GHz
 - : 30dB @ 5.75GHz
- Input 1 dB output compression
 - : 39dBm @ 2.45GHz
 - : 39dBm @ 5.75GHz
- High IIP3
 - : 65dBm @ 2.45GHz
 - : 65dBm @ 5.75GHz
- ESD protection : ±2.0kV @ all pins
- 6-lead UDFN package : 1.5mm x 1.5mm x 0.5mm
- Operating temperature range : -40°C - +105°C
- Lead-free/RoHS2-compliant UDFN package

Electrical Specifications

Typical conditions are at VDD = 3.3V, T_A = 25°C, V1 Low = 0V, V1 High = 3.3V, Z_L = 50Ω, Excluding SMA Connector and PCB loss⁽¹⁾, unless otherwise noted.

Table 1 Electrical Specifications

Parameter	Path	Condition	Min	Typ	Max	Unit
Operating Frequency			5		6000	MHz
Insertion Loss	RFc - RFx	1GHz		0.52		dB
		2GHz		0.55		
		2.45GHz		0.55		
		3GHz		0.57		
		4GHz		0.66		
		5GHz		0.80		
		5.75GHz		0.69		
Isolation	RFc - RFx	1GHz		52		dB
		2GHz		45		
		2.45GHz		42		
		3GHz		39		
		4GHz		35		
		5GHz		35		
		5.75GHz		30		
Isolation	RFx - RFx	1GHz		44		dB
		2GHz		36		
		2.45GHz		34		
		3GHz		33		
		4GHz		29		
		5GHz		26		
		5.75GHz		26		
Return Loss	RFc, RF1, RF2	5MHz – 6GHz (Active port)		20		dB
Input P1dB	RFc - RFx	2.45GHz		39		dBm
		5.75GHz		39		
Input IP3 ⁽²⁾	RFc - RFx	2.45GHz		65		dBm
		5.75GHz		65		
Input IP2 ⁽²⁾	RFc - RFx	2.45GHz		100		dBm
		5.75GHz		100		
2 nd Harmonic ⁽³⁾	RFc - RFx	2.45GHz		90		dBc
		5.75GHz		90		
3 rd Harmonic ⁽³⁾	RFc - RFx	2.45GHz		105		dBc
		5.75GHz		105		
Switching Time	RFc - RFx	50% control to 90% RF		145		ns
		50% control to 10% RF		105		
Settling Time	RFc - RFx	50% CTRL to 0.05dB final value Rising Edge		155		ns
		50% CTRL to 0.05dB final value Falling Edge		115		
Maximum Spurious level ⁽⁴⁾	RFc, RF1, RF2	Measured at RF ports , < 10MHz			<-115	dBm

(1) Excluding SMA Connector and PCB loss. 1GHz (0.12dB), 2GHz (0.20dB), 3GHz (0.27dB), 4GHz (0.35dB), 5GHz (0.51dB), 6GHz (0.52dB)

(2) Tone Power is 18dBm and Tone spacing is 20KHz.

(3) Tone Power is 18dBm.

(4) The unwanted spurious due to built-in negative voltage generator. Typical generated fundamental frequency is 7.2MHz

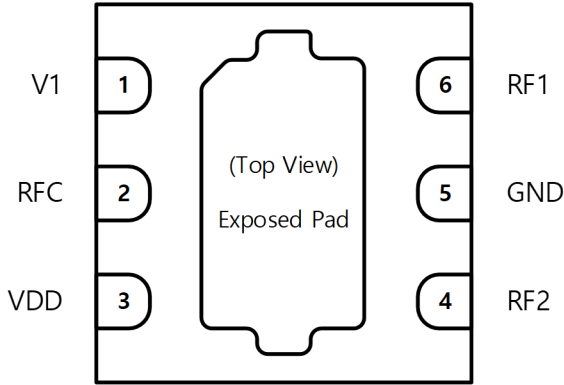
Product Description

Figure 3 Functional Block Diagram
Table 2 Pin Descriptions

No.	Pin Name	Descriptions
1	V1	Digital Control Logic Input
2	RFC	RF Common port
3	VDD	Supply Voltage
4	RF2	RF2 port
5	GND	Ground
6	RF1	RF1 port
Pad	Exposed Pad	Ground

Table 3 V1 Control Truth Table

V1	RFC-RF1	RFC-RF2
0	OFF	ON
1	ON	OFF

Table 4 Operating Ranges*

Parameter	Symbol	Min	Typ	Max	Unit
Supply Voltage	VDD	2.7	3.3	5.0	V
Supply Current	IDD	-	170	-	μA
Digital Input Control (V1)	V1 High	1.0	-	3.3	V
	V1 Low	0	-	0.7	V
Operating Temperature Range	T _O	-40	+25	+105	°C
RF Input Power, CW any port, Z _L =50Ω Freq.=2.45GHz, 5.75GHz	VDD = +3.3V	-	-	27	dBm
	VDD = +5.0V	-	-	20	dBm

*Specifications are not guaranteed over all recommended operating conditions.

Table 5 Absolute Maximum Ratings

Parameter	Symbol	Min	Max	Unit	
Supply Voltage	VDD	-0.3	5.5	V	
Digital Input Voltage (V1)	V1	-0.3	3.6	V	
Maximum Input Power, CW (+25°C)	-	-	Input P1dB	dBm	
Storage Temperature range	-	-65	+150	°C	
ESD	HBM	All pins	-	2000	V
	CDM	All pins	-	1000	V

Typical Performances

Typical conditions are at VDD = 3.3V, T_A = 25°C, V1 Low = 0V, V1 High = 3.3V, Z_L = 50Ω, Excluding SMA Connector and PCB loss, unless otherwise noted.

Figure 4 Insertion Loss vs. Vdd (RFC - RFx)

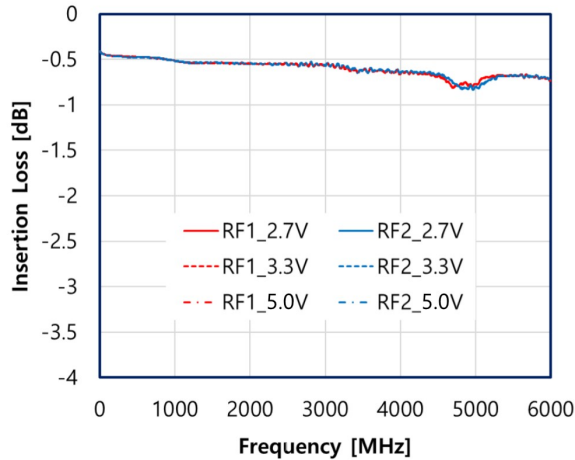

Figure 5 Insertion Loss vs. Temp (RFC - RFx)

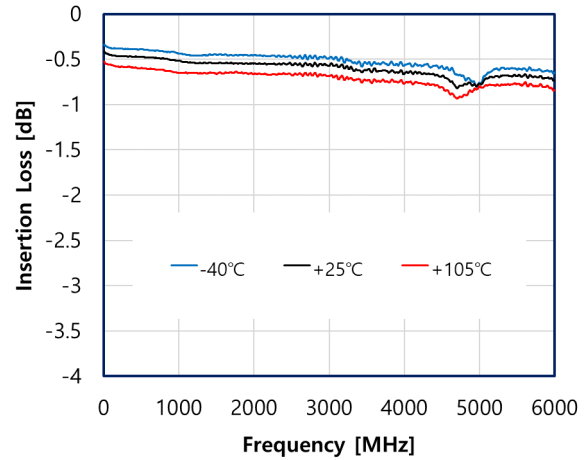

Figure 6 Return Loss (RFC, RFx)

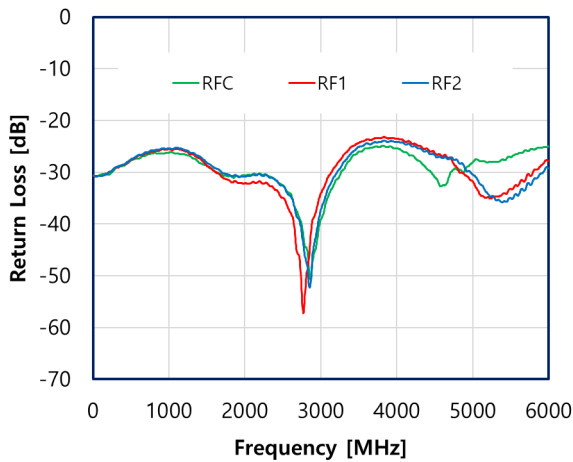
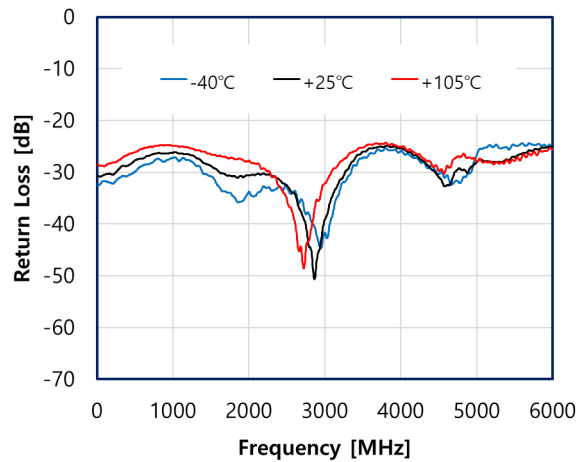

Figure 7 Return Loss vs. Temp (RFC)



Typical Performances

Typical conditions are at VDD = 3.3V, T_A = 25°C, V1 Low = 0V, V1 High = 3.3V, Z_L = 50Ω, Excluding SMA Connector and PCB loss, unless otherwise noted.

Figure 8 Isolation vs. Vdd (RFC - RFx)

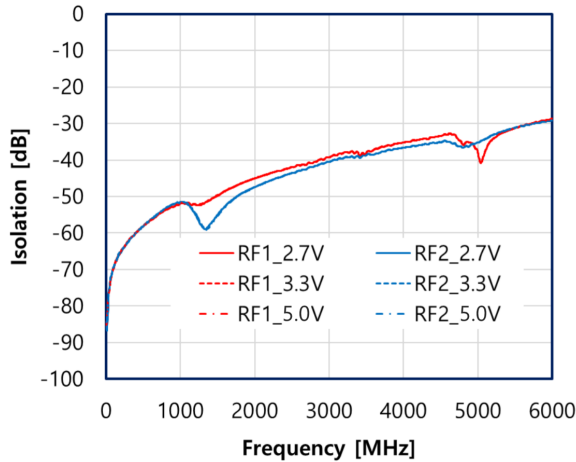

Figure 9 Isolation vs. Temp (RFC-RFx)

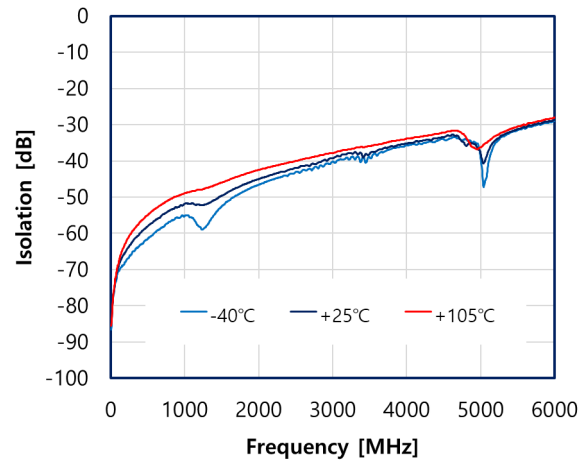

Figure 10 Isolation vs. Vdd (RFx - RFx)

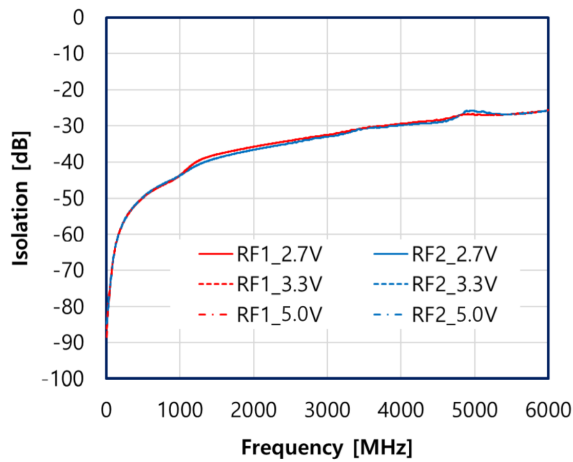
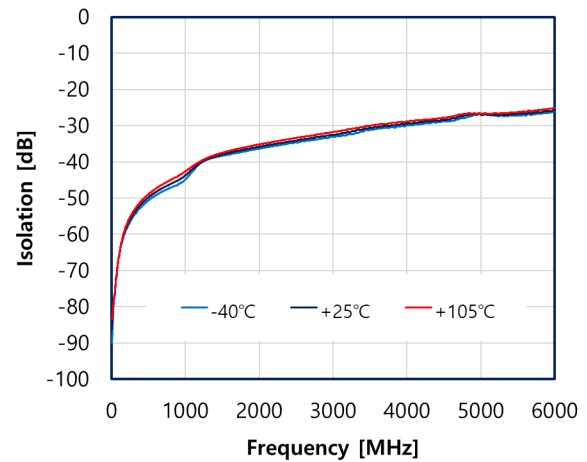

Figure 11 Isolation vs. Temp (RFx - RFx)



Evaluation Board

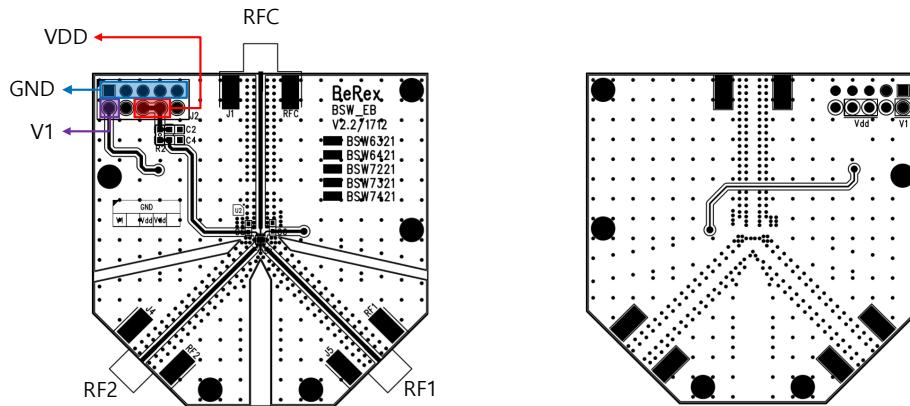

Figure 12 Evaluation Board Layout

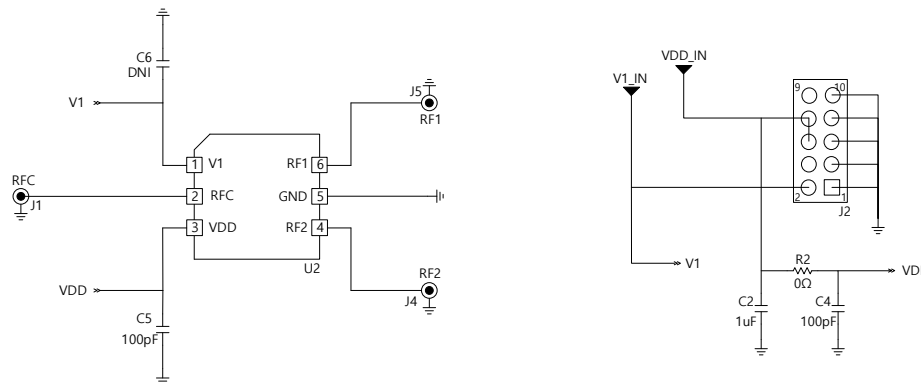

Figure 13 Evaluation Board Schematic

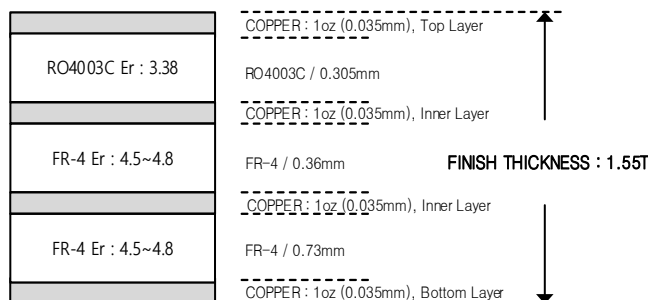
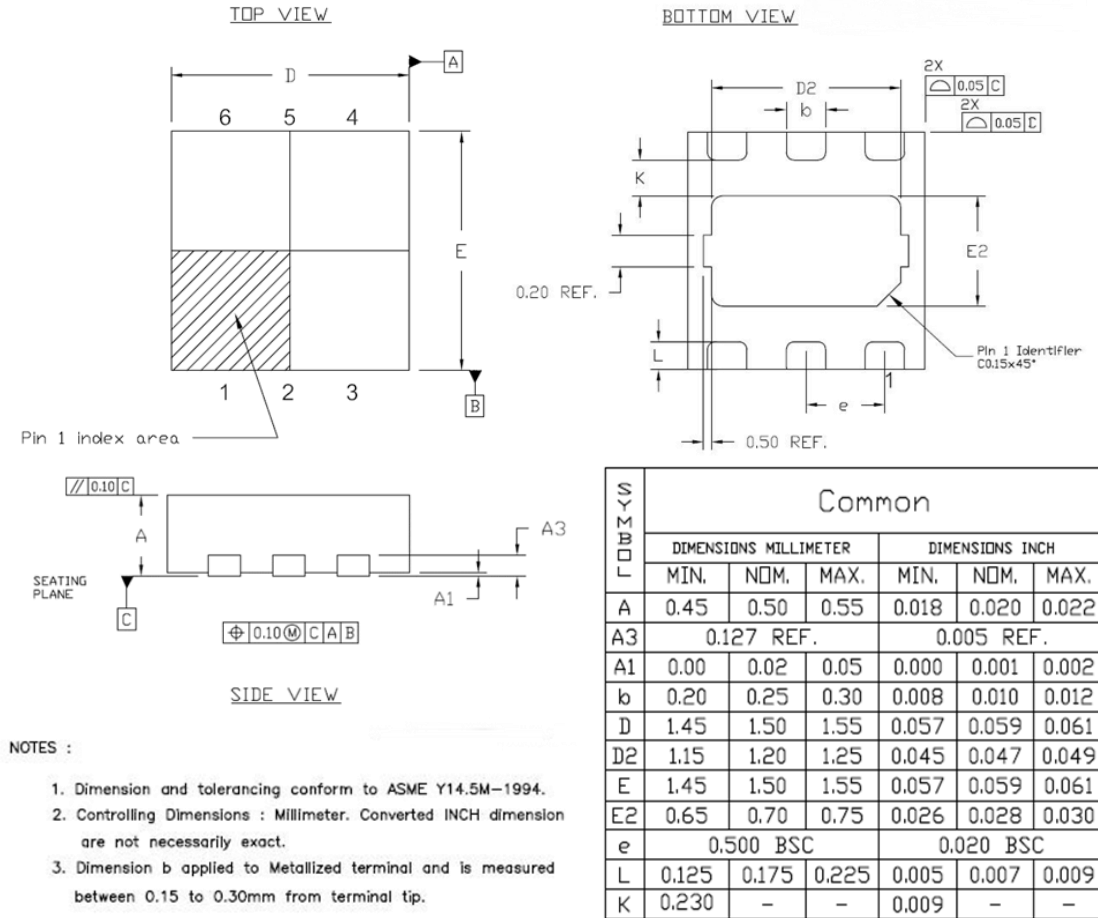
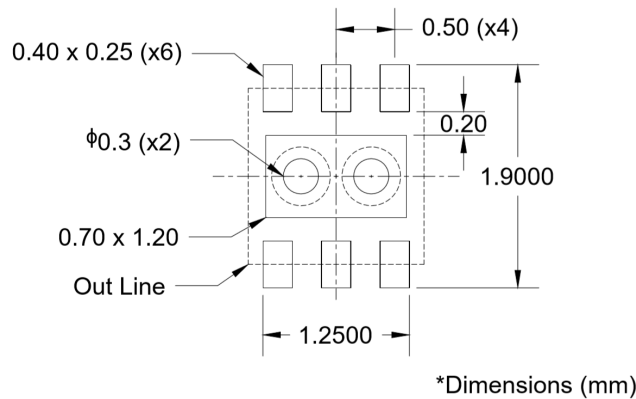

Figure 14 Evaluation Board PCB Layer Information

Table 6 Bill of Material - Evaluation Board

No.	Ref Des	Part Qty	Part Number	Remark
1	C2	1	CAP 1608 1uF J 50V	
2	C4	1	CAP 1608 100pF J 50V	
3	C5*	1	CAP 1005 100pF J 50V	
4	C6	1	CAP 1005 DNI	
5	R2	1	RES 1608 J 0ohm	
6	J2	1	10 Pin Header	
7	RFC, RF1, RF2	3	SMA_END_LAUNCH	
8	U2	1	BSW6321	

* C5 should be placed near the device.

Package Outline Drawing

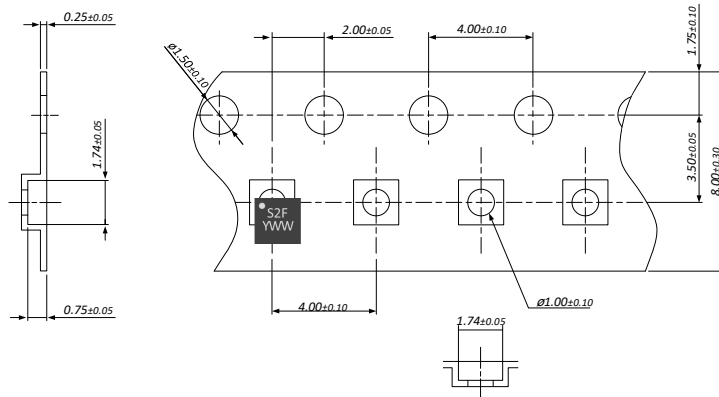
Figure 15 Package Outline Drawing

Figure 16 Recommended Land Pattern

Tape & Reel

Packaging information :

Tape Width (mm) : 8
 Reel Size (inches) : 7
 Device Cavity Pitch (mm) : 4
 Device Per Reel : 3000EA

Figure 17 Tape & Reel
Package Marking

Marking Code 1		Marking Code 2	
S	RF Switch	2	The number of switch throw
2	The number of switch throw	C	Sequential Number
C	Sequential Number	XX	Wafer Lot Number
Y	Work Year		
XX	Wafer Lot Number		

Figure 18 Package Marking
Lead plating finish
100% Tin Matte finish

(All BeRex products undergoes a 1 hour, 150 degree C, Anneal bake to eliminate thin whisker growth concerns.)

MSL / ESD Rating

ESD Rating: Class 2
Value: Passes < 2000V
Test: Human Body Model (HBM)
Standard: JS-001-2017

MSL Rating: Level 1 at +265°C convection reflow
Standard: JEDEC Standard J-STD-020



Proper ESD procedures should be followed when handling this device.

NATO CAGE code:

2	N	9	6	F
---	---	---	---	---