

CD CRIMP TYPE CONNECTOR

General

The model CD connectors are SM Series (sub-miniature) rectangular multi-contact crimping connectors. CD Crimp Type Connectors are Crimp Type D Sub-miniature Connectors for Discrete Wire Terminations.

Available in 9, 15, 25 and 37 way. Terminals available for AWG28 through AWG20. Plug with Grounding dimples is introduced now.

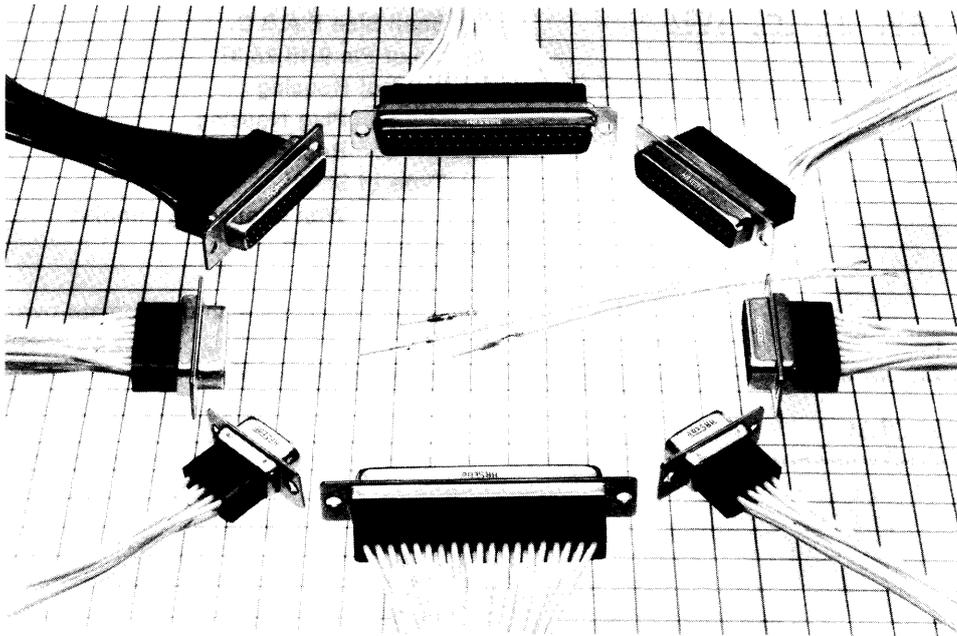

Features

- (1) Compact and sturdy due to metal shell.
- (2) Can be mounted on the front or back of a panel or chassis as necessary.
- (3) Requires no special withdrawal jig (push the retainers from the connector sides to insert/withdraw the connector).
- (4) Uses insulation made from highly heat-resistant and chemical-resistant UL synthetic resin.

Applications

Suitable for modems in communications equipment such as computers, peripherals and terminals, control equipment, measuring instruments, and export equipment.

Electrical and Environmental

Electrical and Environmental Characteristics	
Current capacity	3A
Rated voltage	AC 350V
Insulation resistance	5000mΩ or higher at DC 500V
Contact resistance	25mΩ or less at DC 100mA
Withstand voltage	1 minute at AC 1250Vrms

Material and finish		
Shell	Steel	Treatment with dichromate or zinc plating
Insulator	PBT (GE Valox) *	Black
Contacts	Phosphor bronze	Nickel plating + Gold plating

* UL94V-0

Connector Housing

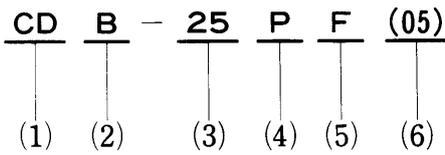

- (1) Series Name CD: Crimping type
- (2) Shell Size E.A.B.C.
- (3) No. of Pin 9,15,25,37
- (4) Type of Housing
 - P: Plug Housing
 - S: Receptance Housing
- (5) Type of Shell
 - F: With Grounding dimples
- (6) Finish of Shell
 - (05) Nickel plated
 - Blank: Treatment with dichromate over zinc plating

Male Connector

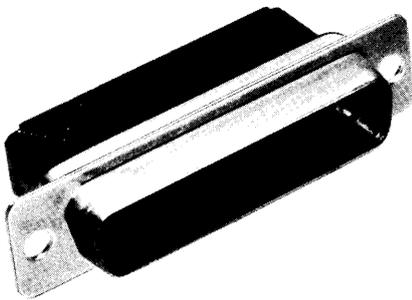

CL211-0211-6
CDB-25P

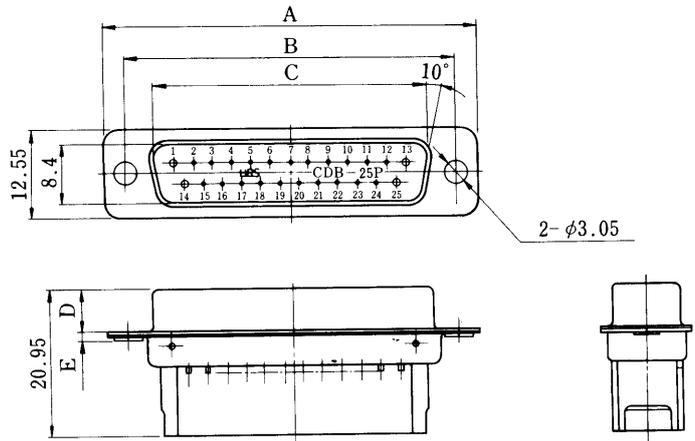

(Unit:mm)

HRS No.	No. of Pin	Part No.	A	B	C	D	E
* CL211-0186-0	9	CDE-9P	30.81	24.99	16.9	5.99	1.2
* CL211-0279-0	15	CDA-15P	39.14	33.32	25.24	5.99	1.2
* CL211-0211-6	25	CDB-25P	53.04	47.04	39.01	5.87	1.3
* CL211-0281-1	37	CDC-37P	69.32	63.5	55.47	5.87	1.4

*:Standard

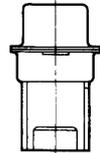
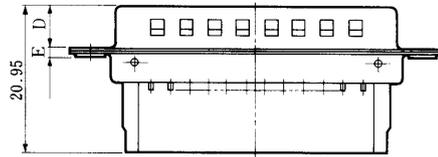
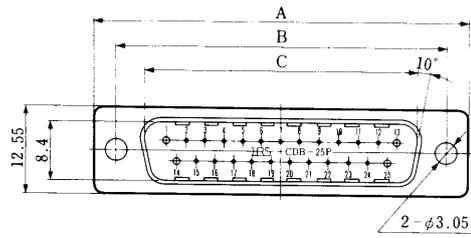
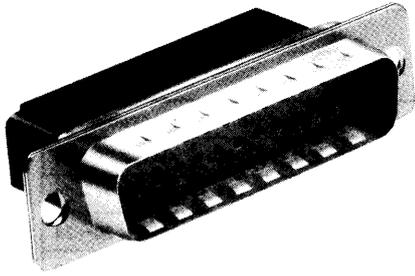

CL211-0602-3-05
CDB-25PF(05)

Unit:mm

HRS No.	No. of Pin	Part No.	A	B	C	D	E
CL211-0600-8-05	9	CDE-9PF(05)	30.81	24.99	16.9	5.99	1.2
CL211-0601-0-05	15	CDA-15PF(05)	39.14	33.32	25.24		
CL211-0602-3-05	25	CDB-25PF(05)	53.04	47.04	39.01	5.87	1.3
CL211-0603-6-05	37	CDC-37PF(05)	69.32	63.5	55.47		

Female Connector

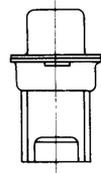
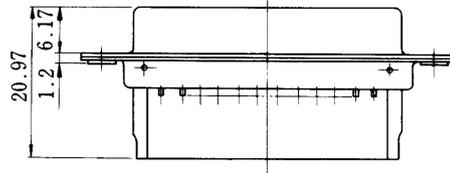
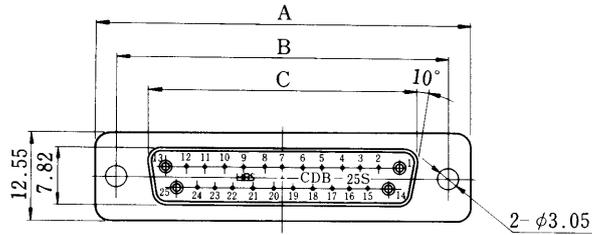
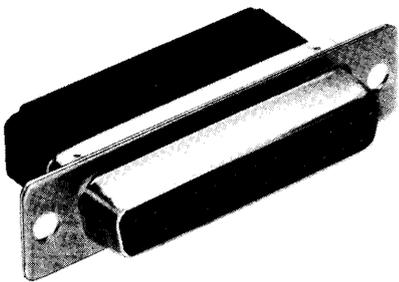

CL211-0212-9
CDB-25S

Unit:mm

HRS No.	No. of Pin	Part No.	A	B	C
* CL211-0207-9	9	CDE-9S	30.81	24.99	16.4
* CL211-0280-9	15	CDA-15S	39.14	33.32	24.59
* CL211-0212-9	25	CDB-25S	53.04	47.04	38.3
* CL211-0282-4	37	CDC-37S	69.32	63.5	54.76

*:Standard

Nickel-Plated version have (05) added to their standard-part numbers

Contact

Male Contact

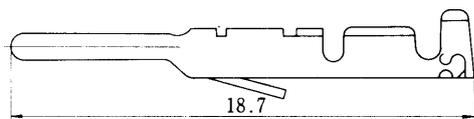

Item	HRS No.	Part No.	Applicable wire
Loose contact	CL211-0185-8	CD-PC-111	AWG # 20~24
	*CL211-0202-5	CD-PC-121	AWG # 24~28
Chain contact	*CL211-0200-0	CD-PC-211	AWG # 20~24
	*CL211-0201-2	CD-PC-221	AWG # 24~28

*: Standard

Female Contact

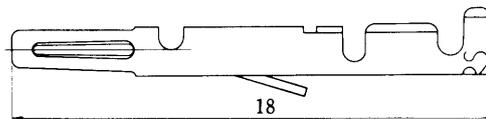

Item	HRS No.	Part No.	Applicable wire
Loose contact	*CL211-0205-3	CD-SC-111	AWG # 20~24
	*CL211-0206-6	CD-SC-121	AWG # 24~28
Chain contact	*CL211-0203-8	CD-SC-211	AWG # 20~24
	*CL211-0204-0	CD-SC-221	AWG # 24~28

*: Standard

Note: Loose-Piece terminals are available in Packs. Each Pack contains 100 terminals. Strip terminals are available in reels. Each contains 10,000 terminals

Connector Mounting Method and Mounting Dimensions

Connector mounted on the face of the panel (front mounting)

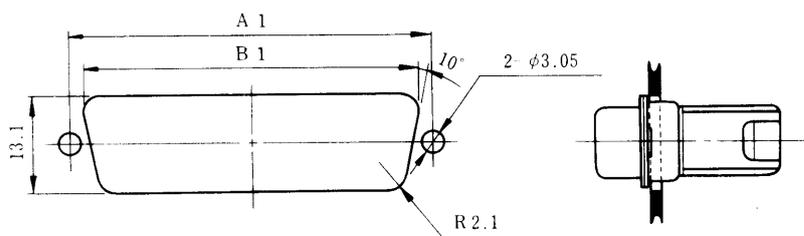

Unit: mm

Shell size	A1	B1
E	24.99	22
A	33.32	30.3
B	47.04	44
C	63.5	60.5

Connector mounted on the back of the panel (rear mounting)

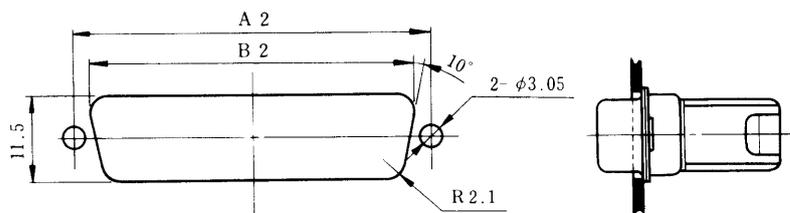

Unit: mm

Shell size	A2	B2
E	24.99	20.2
A	33.32	28.6
B	47.04	42.5
C	63.5	59.2

Assembling Procedure of Crimp Contact

Assembly Steps

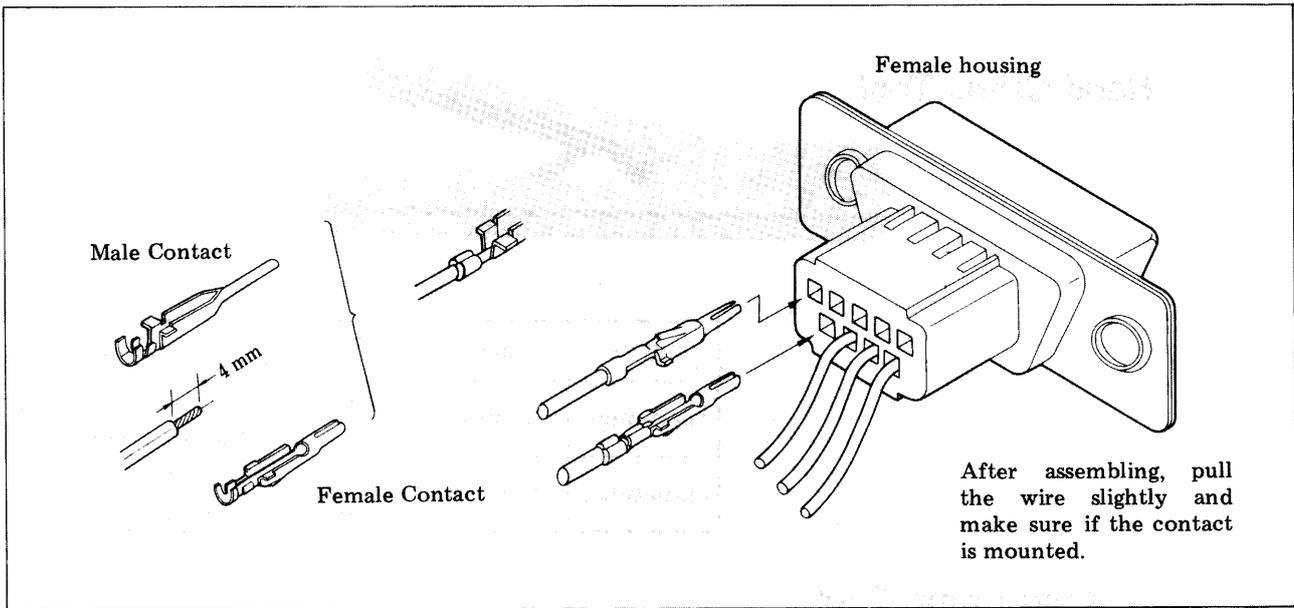

● Procedure for Contact Extraction

In case of extracting a contact from the housing in insertion error or in circuit change, follow the steps as shown below:

- (1) How to extract a contact
Insert a 1.1 x 0.5 mm thick board into the lance-fixed-hole of the housing as shown in Fig. 1 and extract the contact by pulling the wire.

- (2) How to raise up a lance
When the extracted contact is installed again in the housing, please raise up the contact lance as shown in Fig. 2 and then insert it to the housing.

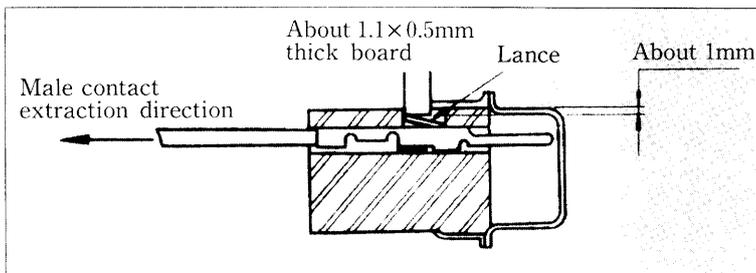

Fig. 1

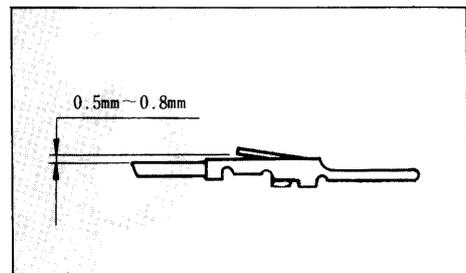
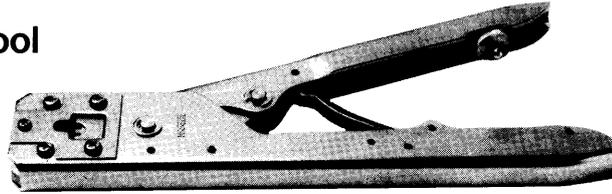

Fig. 2

Figure 1 illustrates a female terminal. This also applies for a mate terminal.

Tools

Hand Crimp Tool



HRS No.	Part No.	Applicable contact	Applicable wire
CL250-0012-2	TC-CD-111	CD-PC-111	AWG-24-20 (Coating O.D.: ϕ 1.5- ϕ 1.9)
		CD-SC-111	
CL250-0013-5	TC-CD-121	CD-PC-121	AWG28-24 (Coating O.D.: ϕ 1.2- ϕ 1.5)
		CD-SC-121	

Auto Crimp Tool

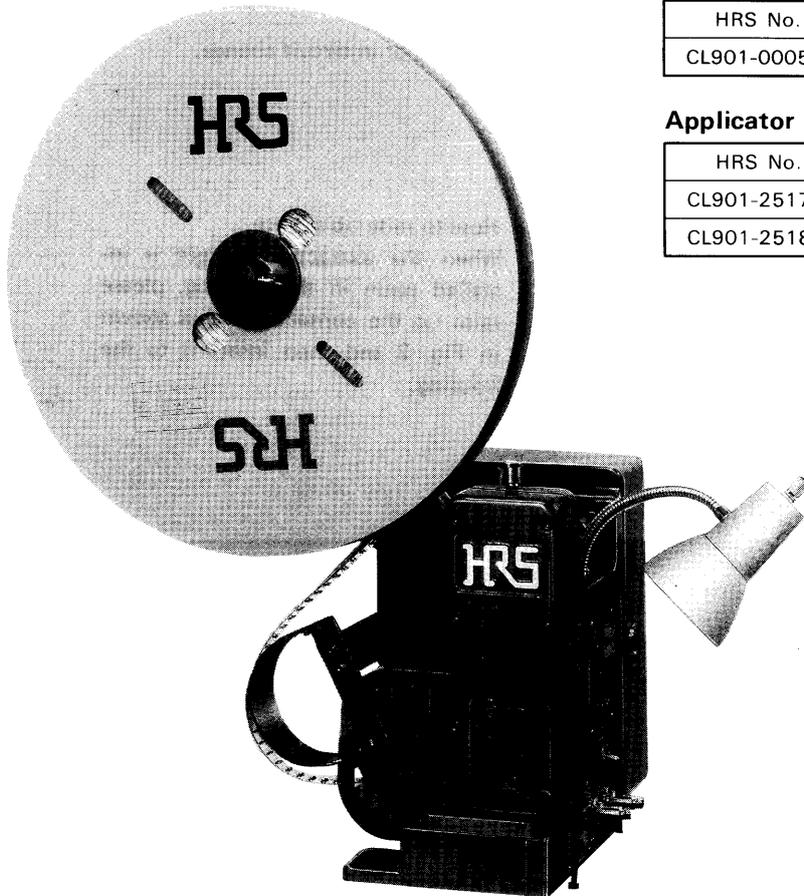

Crimping machine

HRS No.	Part No.
CL901-0005-4	CM-105

Applicator

HRS No.	Part No.	Applicable wire
CL901-2517-7	AP105-CD-1	CD-PC-211
		CD-SC-211
CL901-2518-0	AP105-CD-2	CD-PC-221
		CD-SC-221