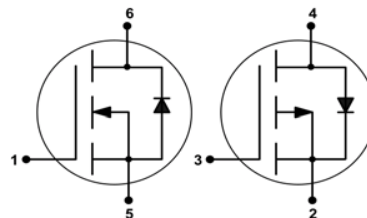
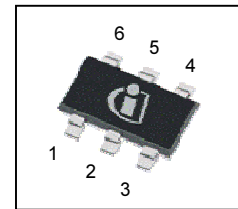

OptiMOS™ 2 + OptiMOS™-P 2 Small Signal Transistor
Product Summary
Features

- Complementary P + N channel
- Enhancement mode
- Logic level (4.5V rated)
- Avalanche rated
- Qualified according to AEC Q101
- 100% lead-free; RoHS compliant

		P	N	
V_{DS}		-30	30	V
$R_{DS(on),max}$	$V_{GS}=\pm 10\text{ V}$	150	160	m Ω
	$V_{GS}=\pm 4.5\text{ V}$	270	280	
I_D		-1.5	1.4	A

PG-TSOP6

Type	Package	Tape and Reel Information	Marking	Lead Free	Packing
BSL316C	PG-TSOP-6	L6327: 3000 pcs / reel	sPJ	Yes	Non dry

Maximum ratings, at $T_j=25\text{ }^\circ\text{C}$, unless otherwise specified ¹⁾

Parameter	Symbol	Conditions	Value		Unit
			P	N	
Continuous drain current	I_D	$T_A=25\text{ }^\circ\text{C}$	-1.5	1.4	A
		$T_A=70\text{ }^\circ\text{C}$	-1.2	1.1	
Pulsed drain current	$I_{D,pulse}$	$T_A=25\text{ }^\circ\text{C}$	-6.0	5.6	
Avalanche energy, single pulse	E_{AS}	P: $I_D=-1.5\text{ A}$, N: $I_D=1.4\text{ A}$, $R_{GS}=25\text{ }\Omega$	11	3.7	mJ
Gate source voltage	V_{GS}		± 20		V
Power dissipation ¹⁾	P_{tot}	$T_A=25\text{ }^\circ\text{C}$	0.5		W
Operating and storage temperature	T_j, T_{stg}		-55 ... 150		$^\circ\text{C}$
ESD class		JESD22-A114-HBM	0 (<250V)		
Soldering temperature	T_{solder}		260		$^\circ\text{C}$
IEC climatic category; DIN IEC 68-1			55/150/56		

¹⁾ Remark: only one of both transistors active

Parameter	Symbol	Conditions	Values			Unit
			min.	typ.	max.	

Thermal characteristics

Thermal resistance, junction - ambient ¹⁾	P	R_{thJA}	minimal footprint ²⁾	-	-	250	K/W
	N						

Electrical characteristics, at $T_j=25\text{ }^\circ\text{C}$, unless otherwise specified
Static characteristics

Drain-source breakdown voltage	P	$V_{(BR)DSS}$	$V_{GS}=0\text{ V}, I_D=-250\text{ }\mu\text{A}$	-	-	-30	V
	N		$V_{GS}=0\text{ V}, I_D=250\text{ }\mu\text{A}$	30	-	-	
Gate threshold voltage	P	$V_{GS(th)}$	$V_{DS}=V_{GS}, I_D=-11\text{ }\mu\text{A}$	-2	-1.5	-1	
	N		$V_{DS}=V_{GS}, I_D=3.7\text{ }\mu\text{A}$	1.2	1.6	2	
Zero gate voltage drain current	P	I_{DSS}	$V_{DS}=-30\text{ V}, V_{GS}=0\text{ V}, T_j=25\text{ }^\circ\text{C}$	-	-	-1	μA
	N		$V_{DS}=30\text{ V}, V_{GS}=0\text{ V}, T_j=25\text{ }^\circ\text{C}$	-	-	1	
	P		$V_{DS}=-30\text{ V}, V_{GS}=0\text{ V}, T_j=150\text{ }^\circ\text{C}$	-	-	-100	
	N		$V_{DS}=30\text{ V}, V_{GS}=0\text{ V}, T_j=150\text{ }^\circ\text{C}$	-	-	100	
Gate-source leakage current	P	I_{GSS}	$V_{GS}=\pm 20\text{ V}, V_{DS}=0\text{ V}$	-	-	± 100	nA
	N						
Drain-source on-state resistance	P	$R_{DS(on)}$	$V_{GS}=-4.5\text{ V}, I_D=-1.1\text{ A}$	-	177	270	m Ω
	N		$V_{GS}=4.5\text{ V}, I_D=-1.1\text{ A}$	-	191	280	
	P		$V_{GS}=-10\text{ V}, I_D=-1.5\text{ A}$	-	113	150	
	N		$V_{GS}=10\text{ V}, I_D=1.4\text{ A}$	-	119	160	
Transconductance	P	g_{fs}	$ V_{DS} >2 I_D R_{DS(on)max}, I_D=-1.18\text{ A}$	-	2.7	-	S
	N		$ V_{DS} >2 I_D R_{DS(on)max}, I_D=1.1\text{ A}$	-	2.3	-	

²⁾ Performed on 40mm² FR4 PCB. The traces are 1mm wide, 70 μm thick and 20mm long; they are present on both sides of the PCB

Parameter	Symbol	Conditions	Values			Unit
			min.	typ.	max.	

Dynamic characteristics

Input capacitance	P	C_{iss}	$V_{GS}=0\text{ V}$, P: $V_{DS}=-15\text{ V}$, N: $V_{DS}=15\text{ V}$, $f=1\text{ MHz}$	-	212	282	pF	
	N			-	71	94		
Output capacitance	P	C_{oss}		-	69	91		
	N			-	26	35		
Reverse transfer capacitance	P	C_{rss}		-	56	84		
	N			-	5	7		
Turn-on delay time	P	$t_{d(on)}$		P: $V_{DD}=-15\text{ V}$, $V_{GS}=-10\text{ V}$, $R_G=6\ \Omega$, $I_D=-1.5\text{ A}$ N: $V_{DD}=15\text{ V}$, $V_{GS}=10\text{ V}$, $R_G=6\ \Omega$, $I_D=1.4\text{ A}$	-	5.0	-	ns
	N				-	3.4	-	
Rise time	P	t_r			-	6.5	-	
	N				-	2.3	-	
Turn-off delay time	P	$t_{d(off)}$	-		14.3	-		
	N		-		5.8	-		
Fall time	P	t_f	-		7.5	-		
	N		-		1.0	-		

Gate Charge Characteristics

Gate to source charge	P	Q_{gs}	$V_{DD}=-15\text{ V}$, $I_D=-1.5\text{ A}$, $V_{GS}=0\text{ to }-5\text{ V}$	-	-0.6	-	nC	
Gate to drain charge		Q_{gd}		-	-1.2	-		
Switching charge		Q_g		-	-2.4	-		
Gate plateau voltage		$V_{plateau}$		-	-2.9	-		
Gate to source charge	N	Q_{gs}		$V_{DD}=15\text{ V}$, $I_D=1.4\text{ A}$, $V_{GS}=0\text{ to }5\text{ V}$	-	0.3	-	
Gate to drain charge		Q_{gd}			-	0.2	-	
Switching charge		Q_g			-	0.6	-	
Gate plateau voltage		$V_{plateau}$			-	3.4	-	

Parameter	Symbol	Conditions	Values			Unit		
			min.	typ.	max.			
Reverse Diode								
Diode continuous forward current	P	I_S	$T_C=25\text{ °C}$	-	-	-0.5	A	
	N			-	-	0.5		
Diode pulse current	P	$I_{S,pulse}$		-	-	-6.0		
	N			-	-	5.6		
Diode forward voltage	P	V_{SD}		$V_{GS}=0\text{ V}, I_F=-1.5\text{ A}, T_j=25\text{ °C}$	-	-0.8	-1.1	V
	N			$V_{GS}=0\text{ V}, I_F=1.4\text{ A}, T_j=25\text{ °C}$	-	0.86	1.1	
Reverse recovery time	P	t_{rr}	$V_R=\pm 15\text{ V}, I_F=I_S, di_F/dt=100\text{ A}/\mu\text{s}$	-	8.2	-	ns	
	N			-	9.1	-		
Reverse recovery charge	P	Q_{rr}		-	2.1	-	nC	
	N			-	2.6	-		

1 Power dissipation (P)

$$P_{\text{tot}} = f(T_A)$$

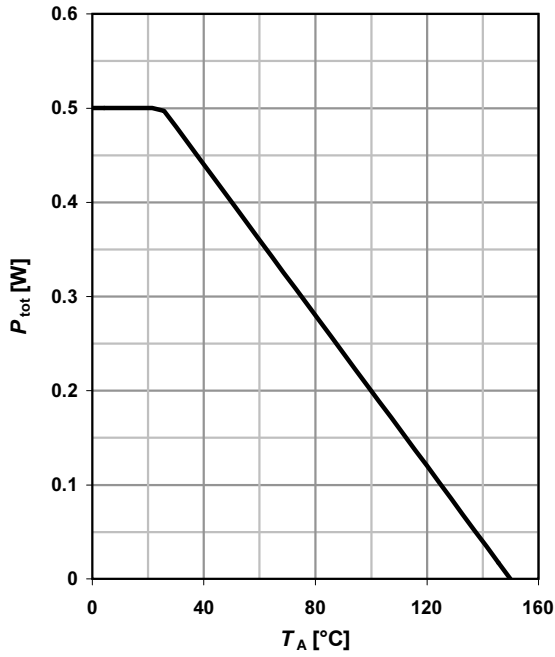

2 Power dissipation (N)

$$P_{\text{tot}} = f(T_A)$$

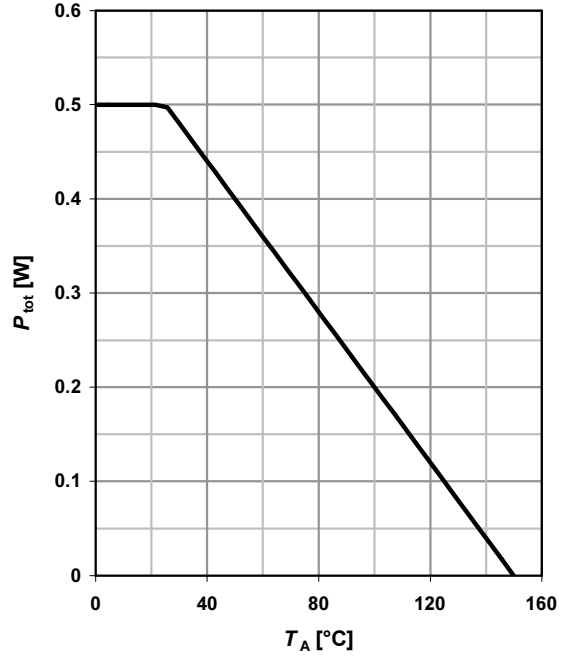

3 Drain current (P)

$$I_D = f(T_A)$$

parameter: $V_{GS} \leq -10$ V

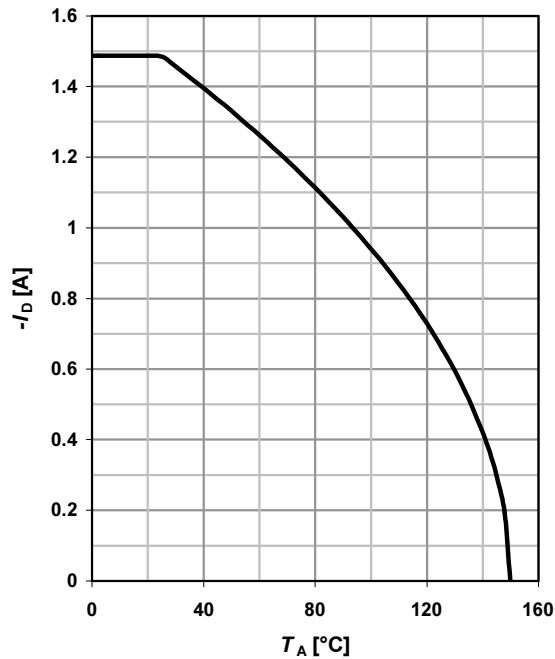

4 Drain current (N)

$$I_D = f(T_A)$$

parameter: $V_{GS} \geq 10$ V

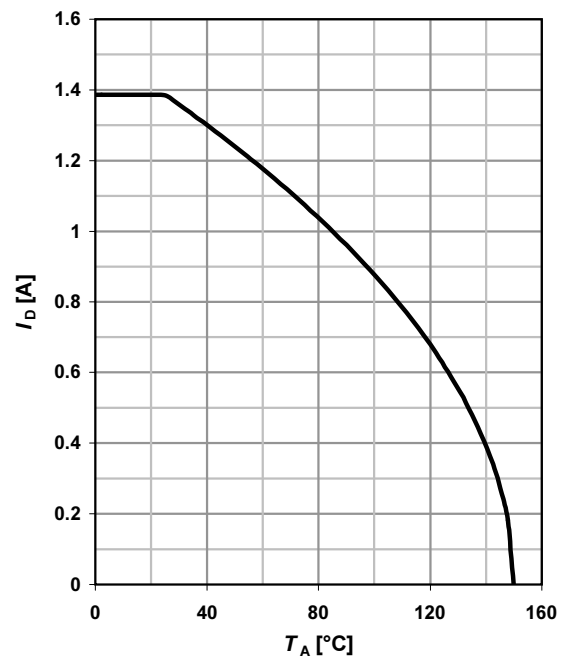

5 Safe operating area (P)

$I_D=f(V_{DS}); T_A=25\text{ }^\circ\text{C}; D=0$

parameter: t_p

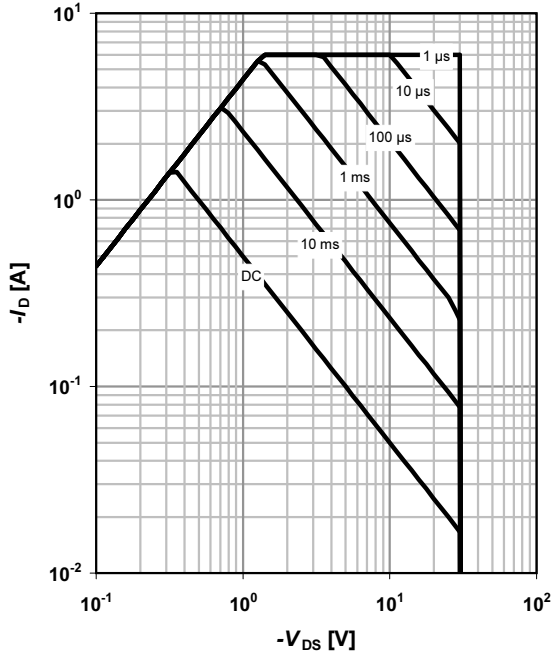

6 Safe operating area (N)

$I_D=f(V_{DS}); T_A=25\text{ }^\circ\text{C}; D=0$

parameter: t_p

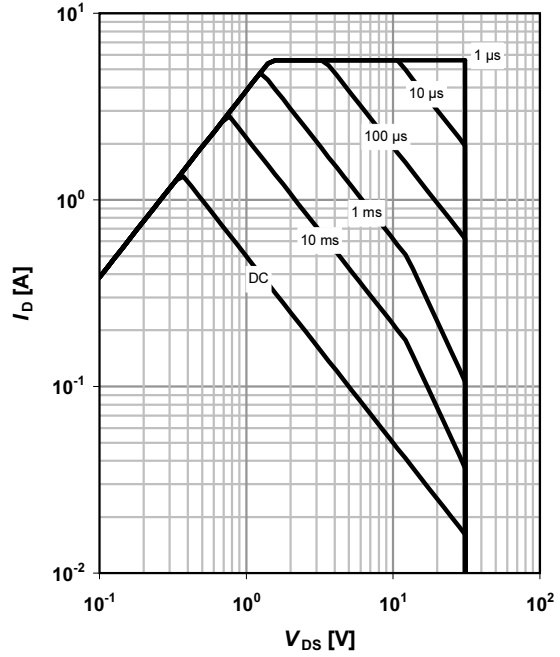

7 Max. transient thermal impedance (P)

$Z_{thJA}=f(t_p)$

parameter: $D=t_p/T$

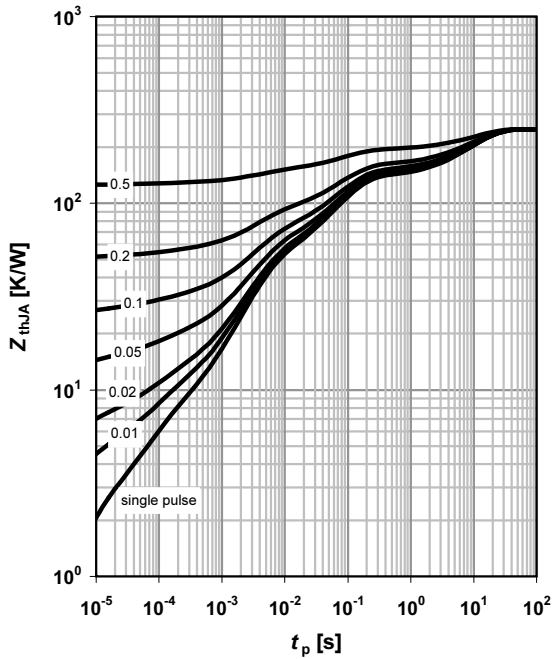

8 Max. transient thermal impedance (N)

$Z_{thJA}=f(t_p)$

parameter: $D=t_p/T$

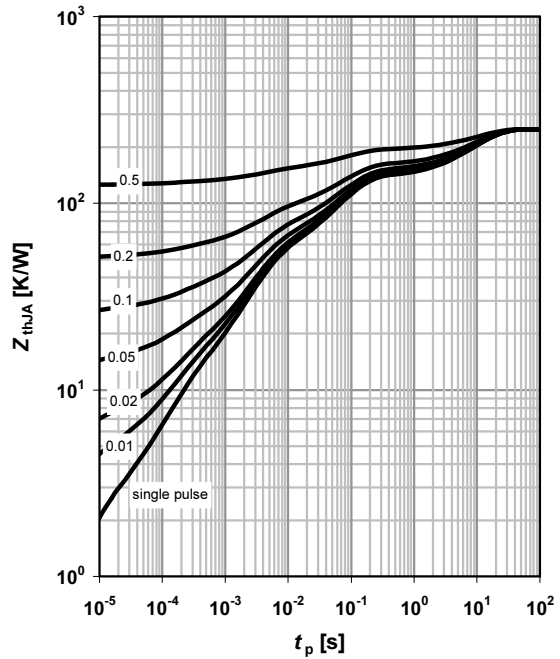

9 Typ. output characteristics (P)

$I_D = f(V_{DS}); T_j = 25\text{ °C}$

parameter: V_{GS}

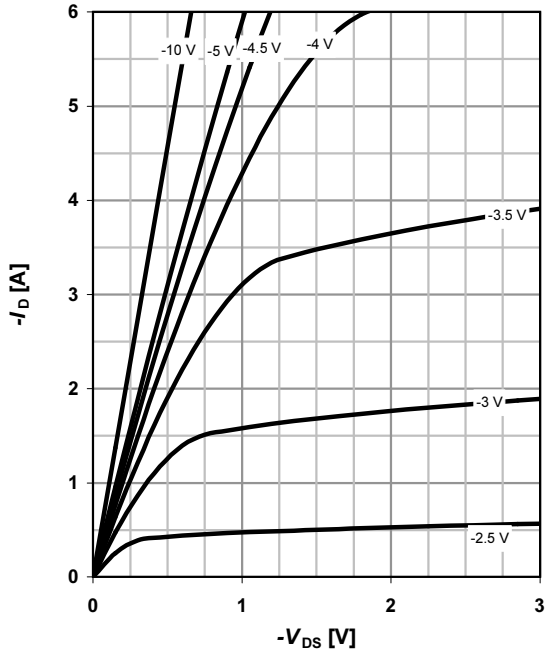

10 Typ. output characteristics (N)

$I_D = f(V_{DS}); T_j = 25\text{ °C}$

parameter: V_{GS}

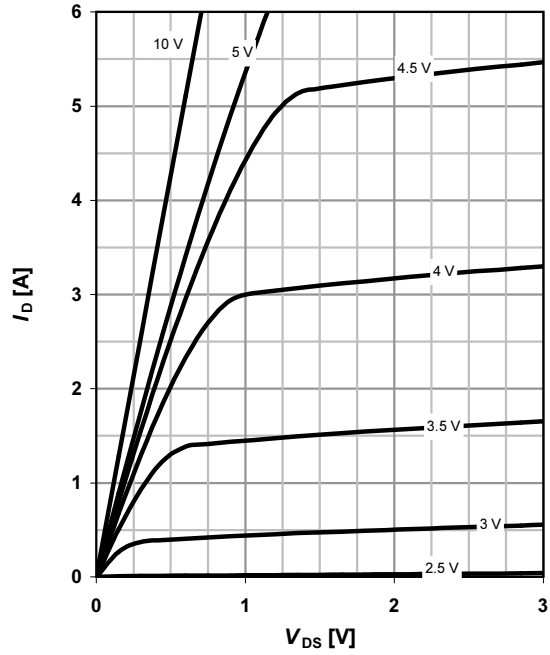

11 Typ. drain-source on resistance (P)

$R_{DS(on)} = f(I_D); T_j = 25\text{ °C}$

parameter: V_{GS}

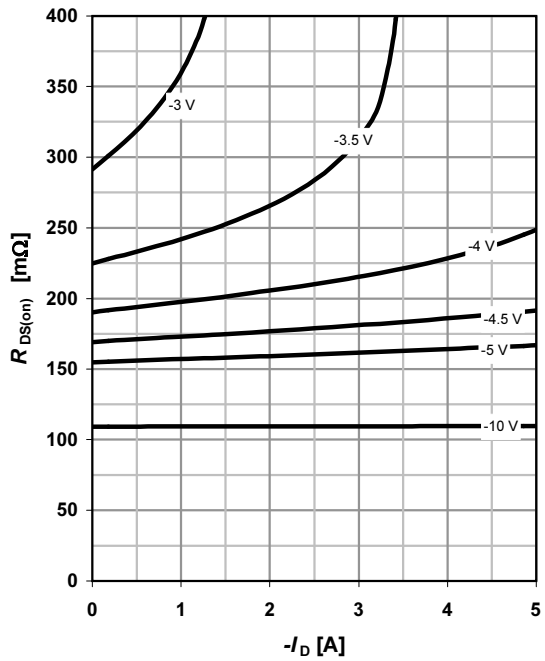

12 Typ. drain-source on resistance (N)

$R_{DS(on)} = f(I_D); T_j = 25\text{ °C}$

parameter: V_{GS}

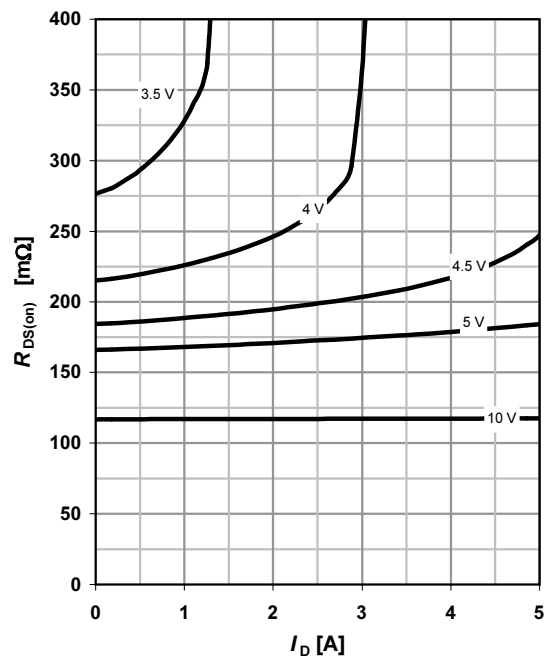

13 Typ. transfer characteristics (P)

$$I_D = f(V_{GS}); |V_{DS}| > 2 |I_D| R_{DS(on)max}$$

parameter: T_j

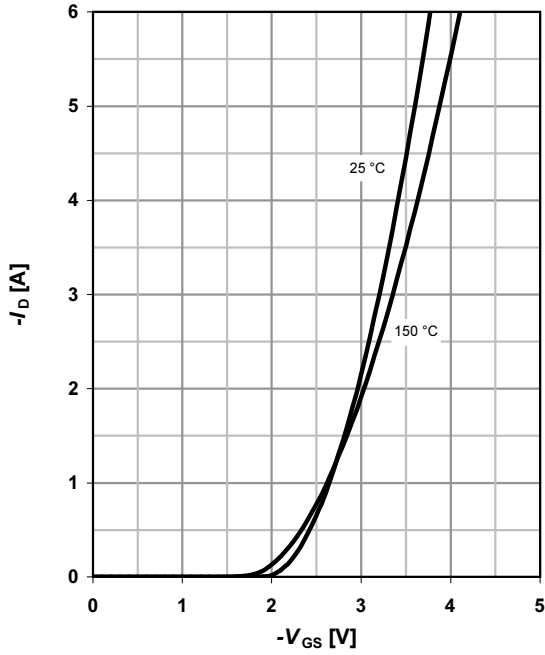

14 Typ. transfer characteristics (N)

$$I_D = f(V_{GS}); |V_{DS}| > 2 |I_D| R_{DS(on)max}$$

parameter: T_j

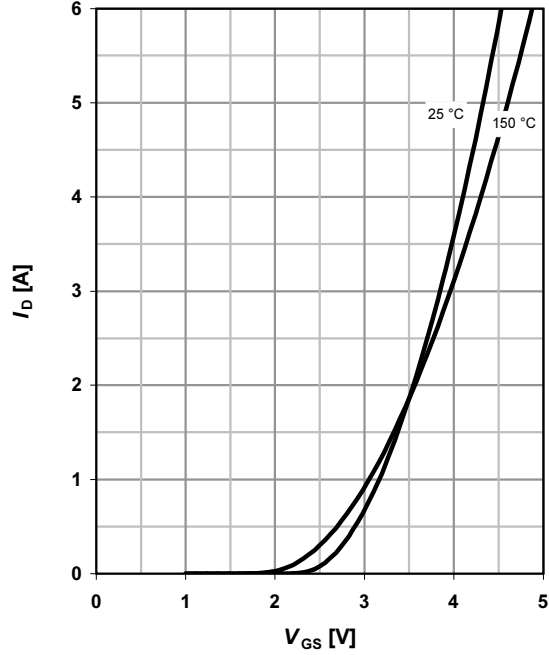

15 Drain-source on-state resistance (P)

$$R_{DS(on)} = f(T_j); I_D = -1.5 \text{ A}; V_{GS} = -10 \text{ V}$$

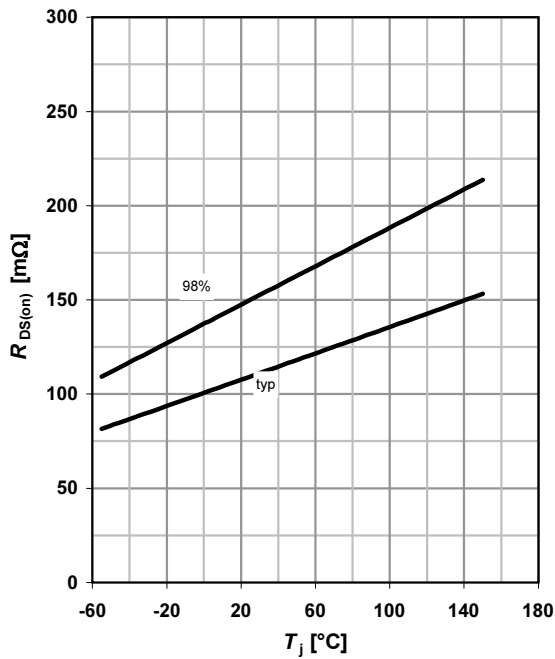

16 Drain-source on-state resistance (N)

$$R_{DS(on)} = f(T_j); I_D = 1.4 \text{ A}; V_{GS} = 10 \text{ V}$$

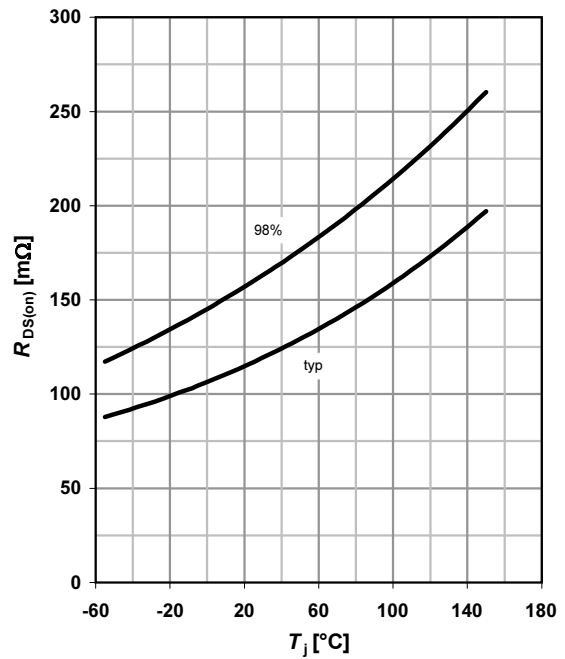

17 Typ. gate threshold voltage (P)

$V_{GS(th)}=f(T_j); V_{GS}=V_{DS}; I_D=-11 \mu A$

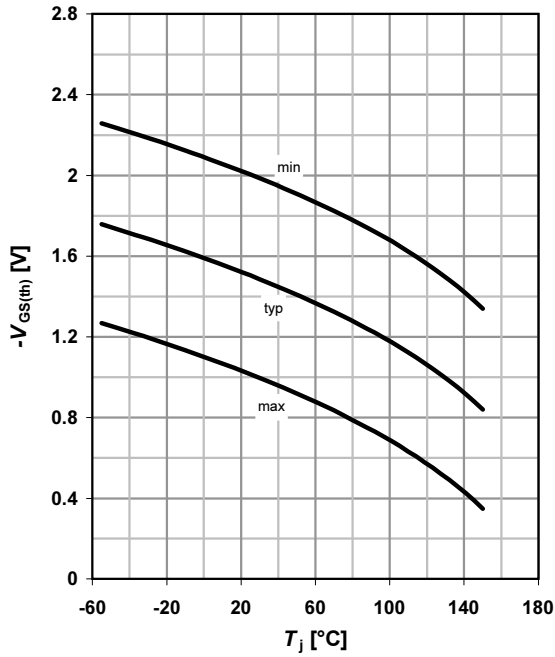

18 Typ. gate threshold voltage (N)

$V_{GS(th)}=f(T_j); V_{GS}=V_{DS}; I_D=3.7 \mu A$

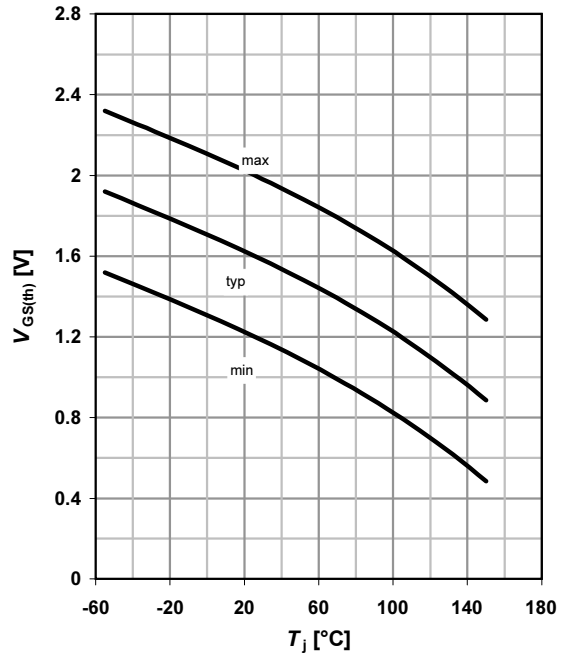

19 Typ. capacitances (P)

$C=f(V_{DS}); V_{GS}=0 V; f=1 MHz$

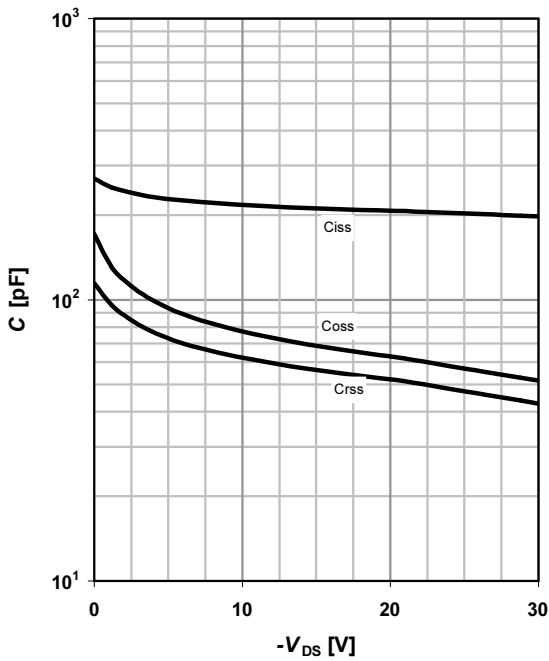

20 Typ. capacitances (N)

$C=f(V_{DS}); V_{GS}=0 V; f=1 MHz$

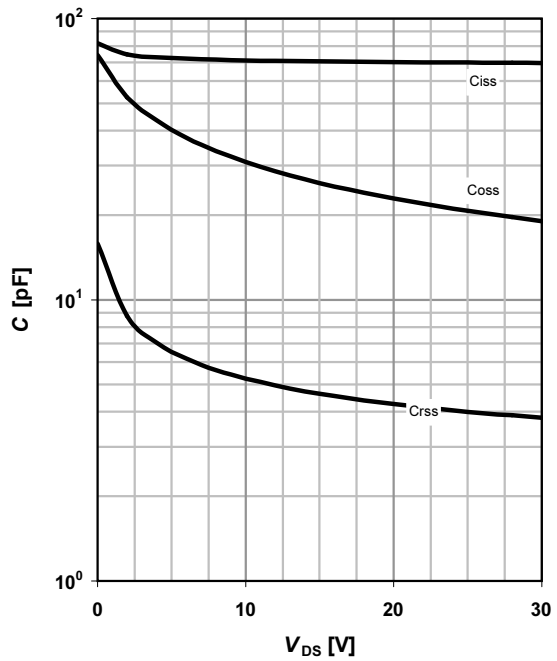

21 Forward characteristics of reverse diode (P)

$I_F=f(V_{SD})$

parameter: T_j

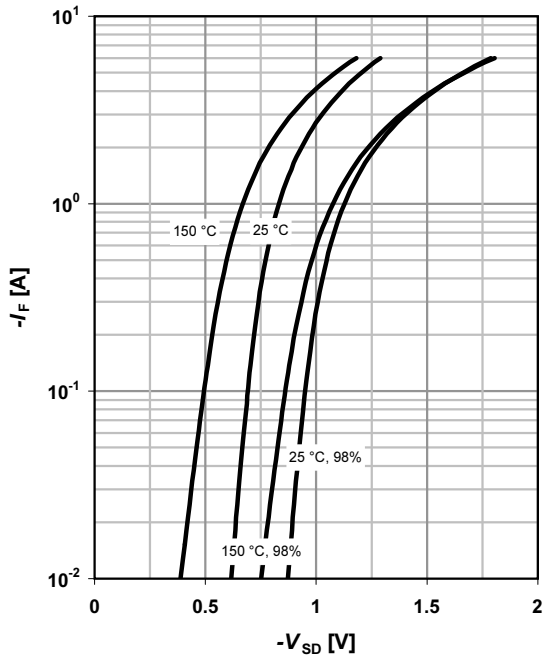

22 Forward characteristics of reverse diode (N)

$I_F=f(V_{SD})$

parameter: T_j

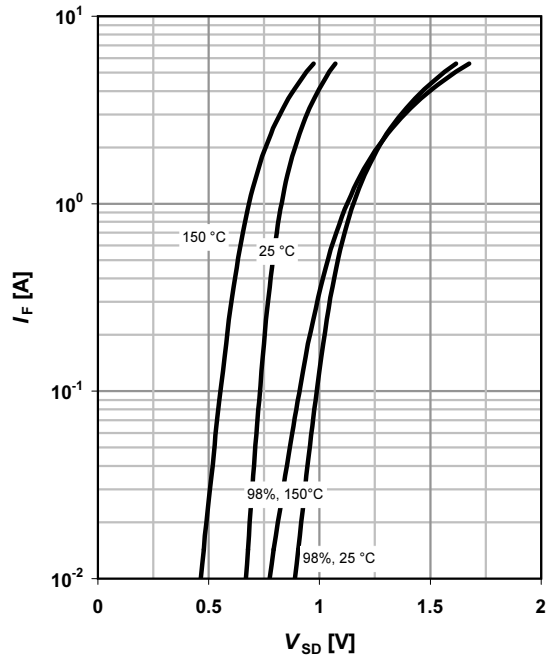

23 Avalanche characteristics (P)

$I_{AS}=f(t_{AV}); R_{GS}=25 \Omega$

parameter: $T_{j(start)}$

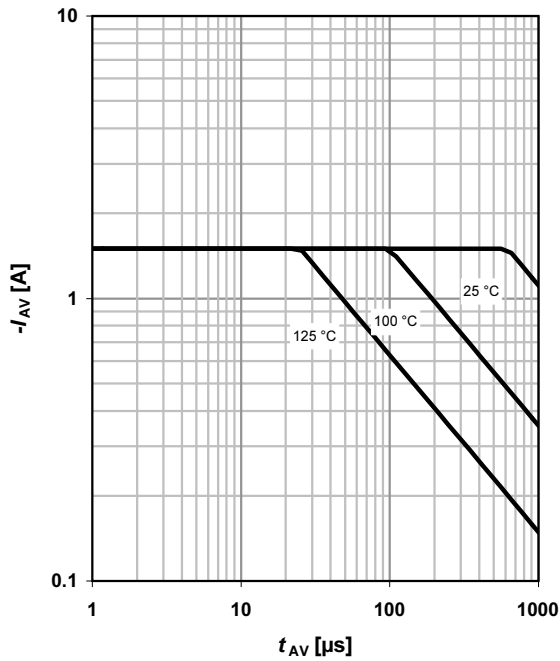

24 Avalanche characteristics (N)

$I_{AS}=f(t_{AV}); R_{GS}=25 \Omega$

parameter: $T_{j(start)}$

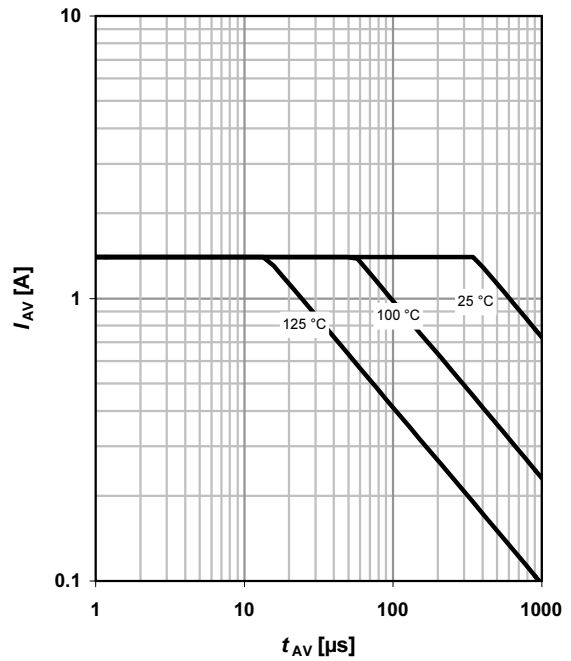

25 Typ. gate charge (P)

$V_{GS}=f(Q_{gate}); I_D=-1.5 \text{ A pulsed}$

parameter: V_{DD}

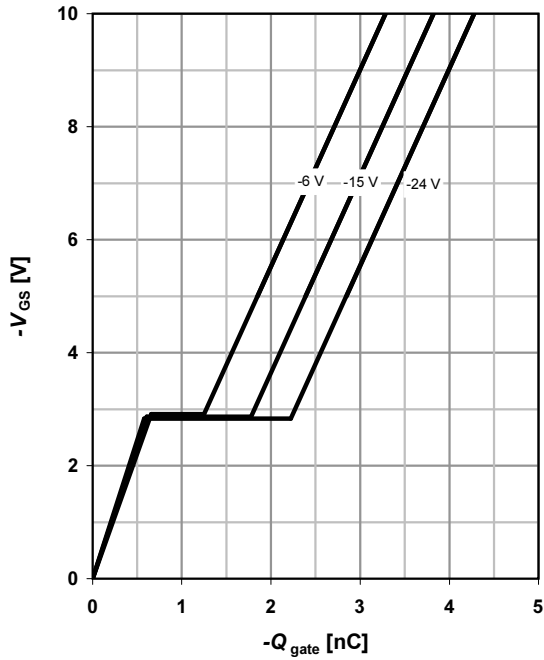

26 Typ. gate charge (N)

$V_{GS}=f(Q_{gate}); I_D=1.4 \text{ A pulsed}$

parameter: V_{DD}

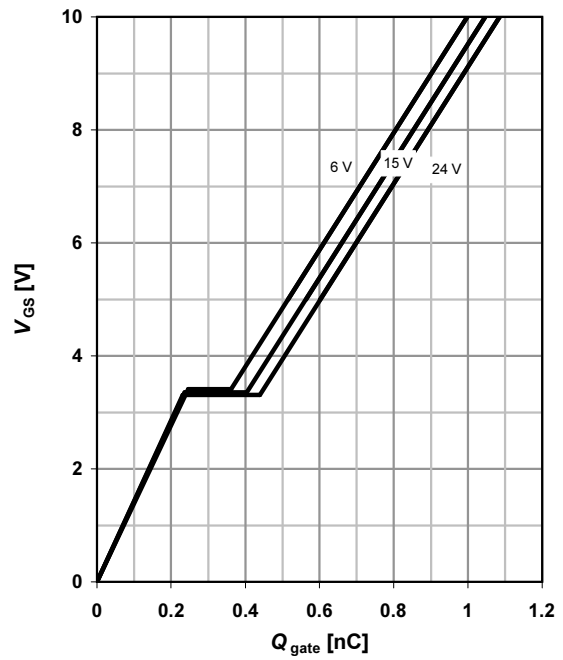

27 Drain-source breakdown voltage (P)

$V_{BR(DSS)}=f(T_j); I_D=-250 \mu\text{A}$

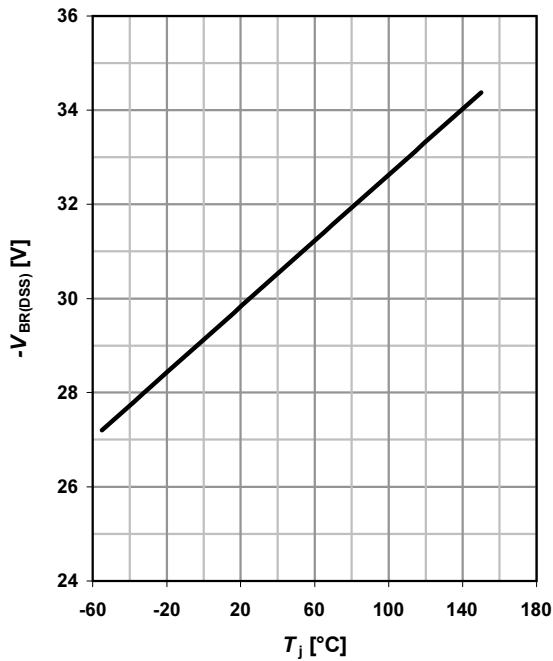

28 Drain-source breakdown voltage (N)

$V_{BR(DSS)}=f(T_j); I_D=250 \mu\text{A}$

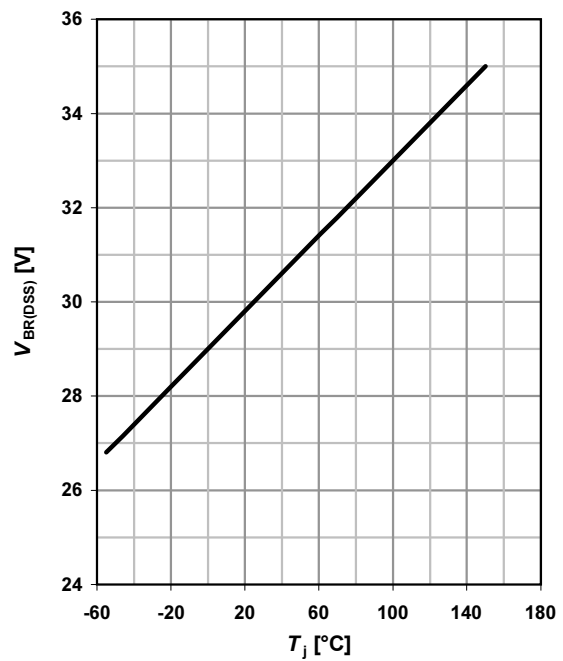

Package Outline:

TSOP6

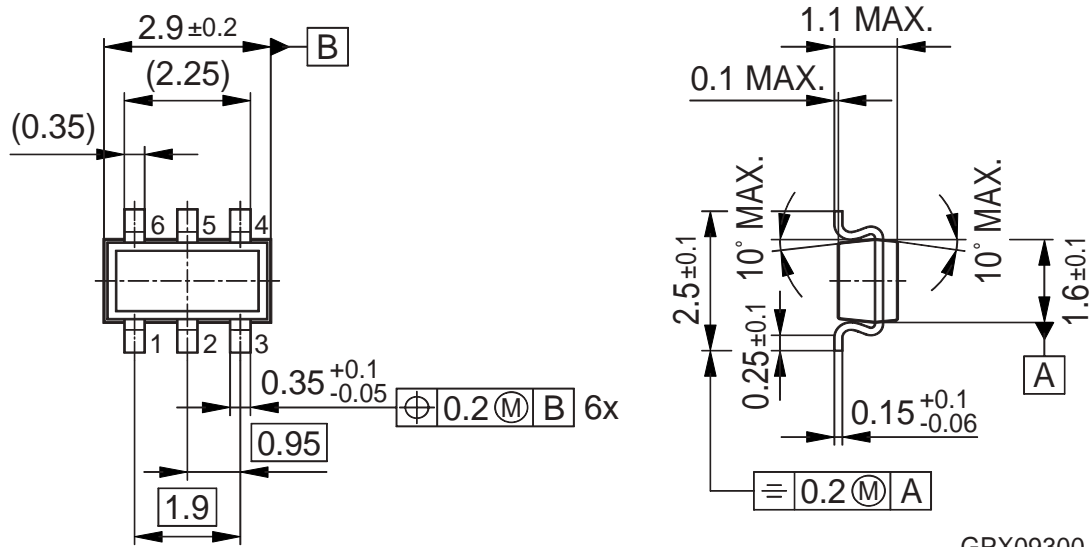

Footprint:

Packaging:

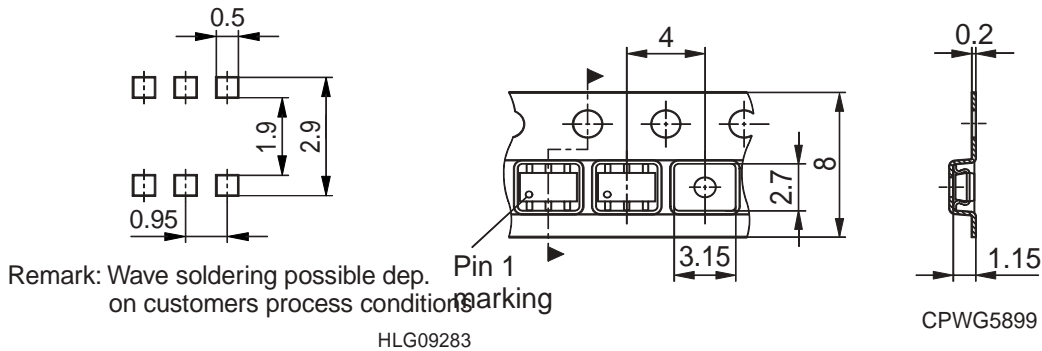

Dimensions in mm

Published by
Infineon Technologies AG
81726 Munich, Germany
© 2008 Infineon Technologies AG
All Rights Reserved.

Legal Disclaimer

The information given in this document shall in no event be regarded as a guarantee of conditions or characteristics. With respect to any examples or hints given herein, any typical values stated herein and/or any information regarding the application of the device, Infineon Technologies hereby disclaims any and all warranties and liabilities of any kind, including without limitation, warranties of non-infringement of intellectual property rights of any third party.

Information

For further information on technology, delivery terms and conditions and prices, please contact the nearest Infineon Technologies Office (www.infineon.com).

Warnings

Due to technical requirements, components may contain dangerous substances. For information on the types in question, please contact the nearest Infineon Technologies Office. The Infineon Technologies component described in this Data Sheet may be used in life-support devices or systems and/or automotive, aviation and aerospace applications or systems only with the express written approval of Infineon Technologies, if a failure of such components can reasonably be expected to cause the failure of that life-support, automotive, aviation and aerospace device or system or to affect the safety or effectiveness of that device or system. Life support devices or systems are intended to be implanted in the human body or to support and/or maintain and sustain and/or protect human life. If they fail, it is reasonable to assume that the health of the user or other persons may be endangered.