

## Features

- 25 ns, 35 ns, and 45 ns read access and R/W cycle time
- Unlimited read/write endurance
- Automatic nonvolatile STORE on power loss
- Nonvolatile STORE under hardware or software control
- Automatic RECALL to SRAM on power up
- Unlimited RECALL cycles
- 1-Million STORE cycles
- 100-year nonvolatile data retention
- Single 5 V  $\pm$  10% power supply
- Commercial, industrial, military temperatures
- 32-Pin 300 mil SOIC (RoHS-compliant)
- 32-Pin CDIP and LCC packages

## Description

The Cypress STK14C88 is a 256 Kb fast static RAM with a nonvolatile Quantum Trap storage element included with each memory cell.

The SRAM provides the fast access and cycle times, ease of use, and unlimited read and write endurance of a normal SRAM.

Data automatically transfers to the nonvolatile storage cells when power loss is detected (the STORE operation). On power up, data is automatically restored to the SRAM (the RECALL operation). Both STORE and RECALL operations are also available under software control.

The Cypress nvSRAM is the first monolithic nonvolatile memory to offer unlimited writes and reads. It is the highest performance, most reliable nonvolatile memory available.

For a complete list of related documentation, click [here](#).

## Logic Block Diagram

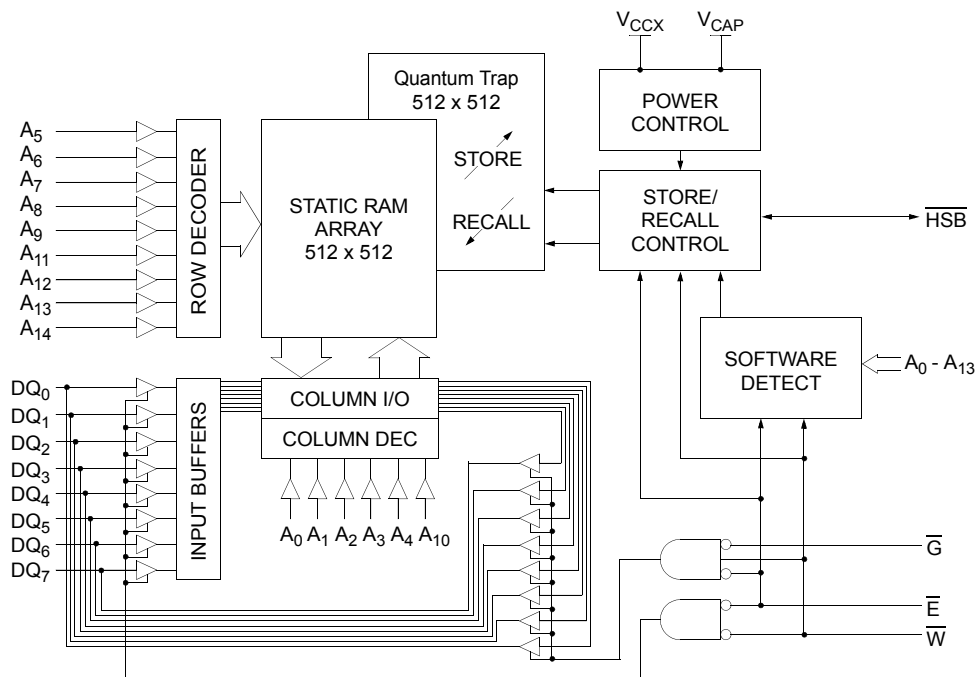

**Contents**

|  |           |  |           |
|--|-----------|--|-----------|
| <b>Pin Configurations .....</b>                    | <b>3</b>  | <b>AutoStore Mode.....</b>                           | <b>11</b> |
| <b>Pin Descriptions .....</b>                      | <b>3</b>  | <b>AutoStore INHIBIT Mode.....</b>                   | <b>12</b> |
| <b>Absolute Maximum Ratings .....</b>              | <b>4</b>  | <b>HSB Operation .....</b>                           | <b>12</b> |
| <b>DC Characteristics .....</b>                    | <b>4</b>  | <b>Best Practices .....</b>                          | <b>13</b> |
| <b>AC Test Conditions .....</b>                    | <b>5</b>  | <b>Preventing STORES .....</b>                       | <b>13</b> |
| <b>Capacitance .....</b>                           | <b>5</b>  | <b>Hardware Protect.....</b>                         | <b>13</b> |
| <b>SRAM Read Cycles #1 and #2 .....</b>            | <b>6</b>  | <b>Low Average Active Power.....</b>                 | <b>13</b> |
| <b>SRAM Write Cycle #1 and #2 .....</b>            | <b>7</b>  | <b>Ordering Information.....</b>                     | <b>14</b> |
| <b>Hardware Mode Selection.....</b>                | <b>8</b>  | Commercial and Industrial Ordering Information.....  | 14        |
| <b>Hardware STORE Cycle .....</b>                  | <b>8</b>  | Military Ordering Information .....                  | 15        |
| <b>AutoStore/Power up RECALL .....</b>             | <b>9</b>  | <b>Package Diagrams.....</b>                         | <b>16</b> |
| <b>Software STORE/RECALL Mode Selection .....</b>  | <b>10</b> | <b>Acronyms .....</b>                                | <b>19</b> |
| <b>Software-Controlled STORE/RECALL Cycle.....</b> | <b>10</b> | <b>Document Conventions .....</b>                    | <b>19</b> |
| <b>nvSRAM Operation.....</b>                       | <b>11</b> | Units of Measure .....                               | 19        |
| <b>Noise Considerations.....</b>                   | <b>11</b> | <b>Document History Page .....</b>                   | <b>20</b> |
| <b>SRAM Read .....</b>                             | <b>11</b> | <b>Sales, Solutions, and Legal Information .....</b> | <b>21</b> |
| <b>SRAM Write .....</b>                            | <b>11</b> | Worldwide Sales and Design Support.....              | 21        |
| <b>Power Up RECALL .....</b>                       | <b>11</b> | Products .....                                       | 21        |
| <b>Software Nonvolatile STORE.....</b>             | <b>11</b> | PSoC Solutions .....                                 | 21        |
| <b>Software Nonvolatile RECALL .....</b>           | <b>11</b> |  |           |

## Pin Configurations

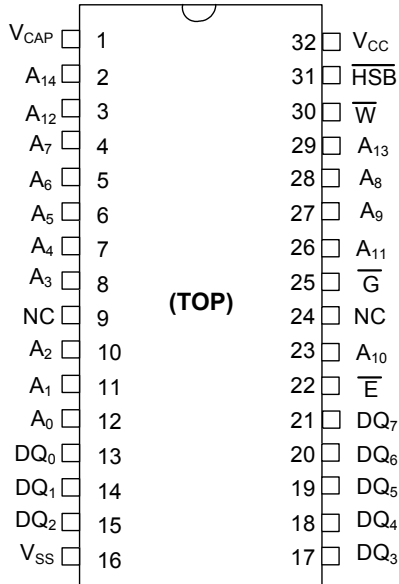
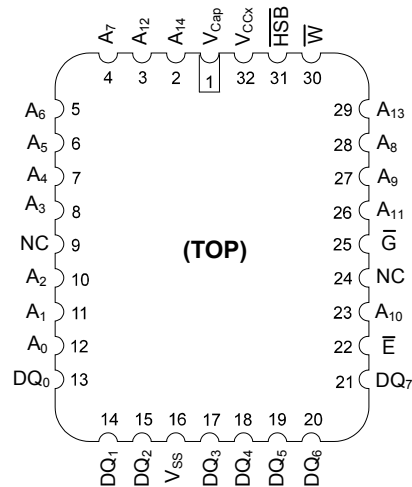
**Figure 1. Pin Diagram - 32-Pin 300 Mil SOIC/CDIP**

**Figure 2. Pin Diagram - 32-Pin 450 Mil LCC**

## Pin Descriptions

| Pin Name                         | I/O          | Description   |
|----------------------------------|--------------|---|
| A <sub>14</sub> -A <sub>0</sub>  | Input        | Address: The 15 address inputs select one of 32,768 bytes in the nvSRAM array.  |
| DQ <sub>7</sub> -DQ <sub>0</sub> | I/O          | Data: Bidirectional 8-bit data bus for accessing the nvSRAM.  |
| E                                | Input        | Chip Enable: The active low E input selects the device.   |
| W                                | Input        | Write Enable: The active low W enables data on the DQ pins to be written to the address location latched by the falling edge of E.  |
| G                                | Input        | Output Enable: The active low G input enables the data output buffers during read cycles. Deasserting G high caused the DQ pins to tristate.  |
| V <sub>CC</sub>                  | Power Supply | Power: 5.0 V ±10%.  |
| HSB                              | I/O          | Hardware Store Busy: When low this output indicates a Store is in progress. When pulled low external to the chip, it initiates a nonvolatile STORE operation. A weak pull-up resistor keeps this pin high if not connected (optional connection). |
| V <sub>CAP</sub>                 | Power Supply | AutoStore Capacitor: Supplies power to nvSRAM during power loss to store data from SRAM to nonvolatile storage elements.  |
| V <sub>SS</sub>                  | Power Supply | Ground.   |
| NC                               | No Connect   | Unlabeled pins have no internal connections.  |

## Absolute Maximum Ratings

Voltage on Input Relative to Ground.....-0.5 V to 7.0 V  
 Voltage on Input Relative to  $V_{SS}$ .....-0.6 V to ( $V_{CC} + 0.5$  V)  
 Voltage on  $DQ_{0-7}$  or  $\overline{HSB}$  .....-0.5 V to ( $V_{CC} + 0.5$  V)  
 Temperature under Bias ..... -55 °C to 125 °C  
 Storage Temperature ..... -65 °C to 150 °C  
 Power Dissipation ..... 1 W  
 DC Output Current (1 output at a time, 1s duration).... 15 mA

**Note** Stresses greater than those listed under “Absolute Maximum Ratings” may cause permanent damage to the device. This is a stress rating only, and functional operation of the device at conditions above those indicated in the operational sections of this specification is not implied. Exposure to absolute maximum rating conditions for extended periods may affect reliability.

## DC Characteristics

Over the operating range ( $V_{CC} = 5.0$  V  $\pm$  10%)<sup>[4]</sup>

| Symbol          | Parameter  | Commercial    |                | Industrial/<br>Military |                 | Unit           | Notes  |
|-----------------|--|---------------|----------------|-------------------------|-----------------|----------------|--|
|                 |  | Min           | Max            | Min                     | Max             |                |  |
| $I_{CC1}^{[1]}$ | Average $V_{CC}$ current   | –             | 97<br>80<br>70 | –                       | 100<br>85<br>70 | mA<br>mA<br>mA | $t_{AVAV} = 25$ ns<br>$t_{AVAV} = 35$ ns<br>$t_{AVAV} = 45$ ns   |
| $I_{CC2}^{[2]}$ | Average $V_{CC}$ current during STORE                                | –             | 3              | –                       | 3               | mA             | All Inputs Don't Care, $V_{CC} = \max$   |
| $I_{CC3}^{[1]}$ | Average $V_{CC}$ Current at $t_{AVAV} = 200$ ns<br>5V, 25°C, Typical | –             | 10             | –                       | 10              | mA             | $\overline{W} \geq (V_{CC} - 0.2$ V)<br>All others cycling, CMOS levels  |
| $I_{CC4}^{[2]}$ | Average $V_{CAP}$ current during AutoStore Cycle                     | –             | 2              | –                       | 2               | mA             | All Inputs Don't Care  |
| $I_{SB1}^{[3]}$ | Average $V_{CC}$ current (Standby, Cycling TTL Input Levels)         | –             | 30<br>25<br>22 | –                       | 31<br>26<br>23  | mA<br>mA<br>mA | $t_{AVAV} = 25$ ns, $\overline{E} \geq V_{IH}$<br>$t_{AVAV} = 35$ ns, $\overline{E} \geq V_{IH}$<br>$t_{AVAV} = 45$ ns, $\overline{E} \geq V_{IH}$ |
| $I_{SB2}^{[3]}$ | $V_{CC}$ Standby current (Standby, Stable CMOS Input Levels)         | –             | 1.5            | –                       | 1.5             | mA             | $\overline{E} \geq (V_{CC} - 0.2$ V)<br>All Others $V_{IN} \leq 0.2$ V or $\geq (V_{CC} - 0.2$ V)  |
| $I_{ILK}$       | Input Leakage current  | –             | $\pm 1$        | –                       | $\pm 1$         | $\mu$ A        | $V_{CC} = \max$<br>$V_{IN} = V_{SS}$ to $V_{CC}$   |
| $I_{OLK}$       | Off-State output leakage current                                     | –             | $\pm 5$        | –                       | $\pm 5$         | $\mu$ A        | $V_{CC} = \max$<br>$V_{IN} = V_{SS}$ to $V_{CC}$ , $\overline{E}$ or $\overline{G} \geq V_{IH}$  |
| $V_{IH}$        | Input Logic “1” voltage  | 2.2           | $V_{CC} + 0.5$ | 2.2                     | $V_{CC} + 0.5$  | V              | All inputs   |
| $V_{IL}$        | Input Logic “0” voltage  | $V_{SS} - .5$ | 0.8            | $V_{SS} - .5$           | 0.8             | V              | All inputs   |
| $V_{OH}$        | Output Logic “1” voltage   | 2.4           | –              | 2.4                     | –               | V              | $I_{OUT} = -4$ mA except $\overline{HSB}$  |
| $V_{OL}$        | Output Logic “0” voltage   | –             | 0.4            | –                       | 0.4             | V              | $I_{OUT} = 8$ mA except $\overline{HSB}$   |
| $V_{BL}$        | Logic “0” voltage on $\overline{HSB}$ output                         | –             | 0.4            | –                       | 0.4             | V              | $I_{OUT} = 3$ mA   |
| $T_A$           | Operating temperature  | 0             | 70             | -40/-55                 | 85/125          | °C             |  |

### Notes

- $I_{CC1}$  and  $I_{CC3}$  are dependent on output loading and cycle rate. The specified values are obtained with outputs unloaded.
- $I_{CC2}$  and  $I_{CC4}$  are the average currents required for the duration of the respective STORE cycles ( $t_{STORE}$ ).
- $\overline{E} \geq V_{IH}$  does not produce standby current levels until any nonvolatile cycle in progress has timed out.
- $V_{CC}$  reference levels throughout this datasheet refer to  $V_{CC}$  if that is where the power supply connection is made, or  $V_{CAP}$  if  $V_{CC}$  is connected to ground.

**AC Test Conditions**

Input pulse levels..... 0 V to 3 V  
 Input rise and fall times ..... ≤5 ns  
 Input and output timing reference levels ..... 1.5 V  
 Output load ..... See Figure 3

**Figure 3. AC Output Loading**

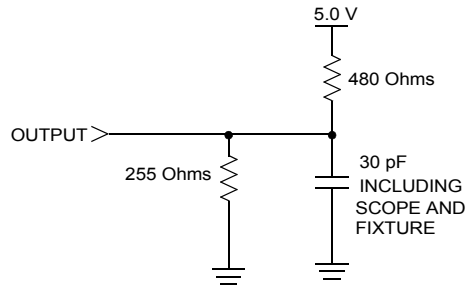

**Capacitance**

| Parameter <sup>[5]</sup> | Description        | Test Conditions                    | Max | Unit | Conditions    |
|--------------------------|--------------------|------------------------------------|-----|------|---------------|
| C <sub>IN</sub>          | Input capacitance  | T <sub>A</sub> = 25 °C, f = 1 MHz, | 5   | pF   | ΔV = 0 to 3 V |
| C <sub>OUT</sub>         | Output capacitance |                                    | 7   | pF   | ΔV = 0 to 3 V |

**Note**  
 5. These parameters are guaranteed but not tested.

SRAM Read Cycles #1 and #2

(V<sub>CC</sub> = 5.0 V ± 10%)<sup>[9]</sup>

| NO. | Symbols  |                  | Parameter   | STK14C88-25 |     | STK14C88-35 |     | STK14C88-45 |     | Unit |
|-----|--|------------------|---|-------------|-----|-------------|-----|-------------|-----|------|
|     | #1, #2   | Alt.             |   | Min         | Max | Min         | Max | Min         | Max |      |
| 1   | t <sub>ELQV</sub>  | t <sub>ACS</sub> | Chip enable access time                           | –           | 25  | –           | 35  | –           | 45  | ns   |
| 2   | t <sub>AVAV</sub> <sup>[6]</sup> , t <sub>LEH</sub> <sup>[6]</sup> | t <sub>RC</sub>  | Read cycle time                                   | 25          | –   | 35          | –   | 45          | –   | ns   |
| 3   | t <sub>AVQV</sub> <sup>7</sup>                                     | t <sub>AA</sub>  | Address access time                               | –           | 25  | –           | 35  | –           | 45  | ns   |
| 4   | t <sub>GLQV</sub>  | t <sub>OE</sub>  | Output enable to data valid                       | –           | 10  | –           | 15  | –           | 20  | ns   |
| 5   | t <sub>AXQX</sub> <sup>[7]</sup>                                   | t <sub>OH</sub>  | Output hold after address change                  | 5           | –   | 5           | –   | 5           | –   | ns   |
| 6   | t <sub>ELQX</sub>  | t <sub>LZ</sub>  | Address change or chip enable to output active    | 5           | –   | 5           | –   | 5           | –   | ns   |
| 7   | t <sub>EHQZ</sub> <sup>[8]</sup>                                   | t <sub>HZ</sub>  | Address change or chip disable to output inactive | –           | 10  | –           | 13  | –           | 15  | ns   |
| 8   | t <sub>GLQX</sub>  | t <sub>OLZ</sub> | Output enable to output active                    | 0           | –   | 0           | –   | 0           | –   | ns   |
| 9   | t <sub>GHQZ</sub> <sup>[8]</sup>                                   | t <sub>OHZ</sub> | Output disable to output inactive                 | –           | 10  | –           | 13  | –           | 15  | ns   |
| 10  | t <sub>ELICCH</sub> <sup>[10]</sup>                                | t <sub>PA</sub>  | Chip enable to power active                       | 0           | –   | 0           | –   | 0           | –   | ns   |
| 11  | t <sub>EHICCL</sub> <sup>[10]</sup>                                | t <sub>PS</sub>  | Chip disable to power standby                     | –           | 25  | –           | 35  | –           | 45  | ns   |

Figure 4. SRAM Read Cycle 1: Address Controlled <sup>[6, 7]</sup>

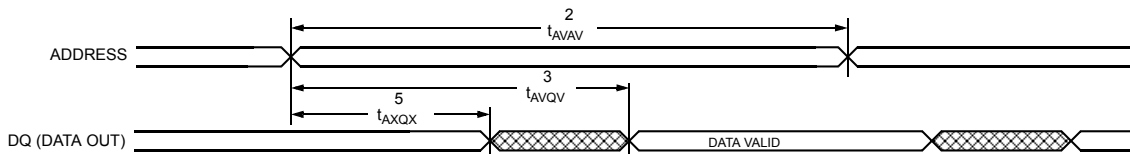
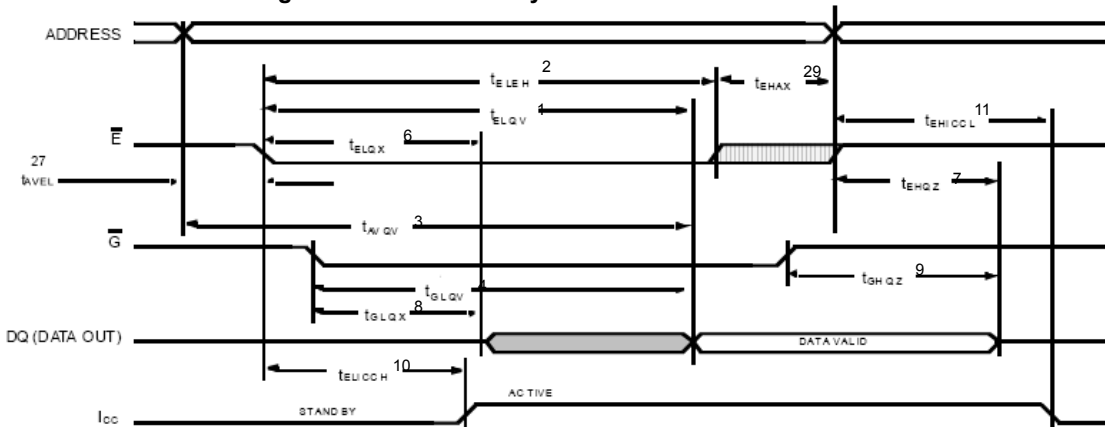

Figure 5. SRAM Read Cycle 2:  $\bar{E}$  and  $\bar{G}$  Controlled <sup>[6]</sup>



Notes

- 6. W and HSB must be high during SRAM read cycles.
- 7. I/O state assumes  $\bar{E}$  and  $\bar{G} \leq V_{IL}$  and  $\bar{W} \geq V_{IH}$ ; device is continuously selected.
- 8. Measured ± 200 mV from steady state output voltage.
- 9. V<sub>CC</sub> reference levels throughout this datasheet refer to V<sub>CC</sub> if that is where the power supply connection is made, or V<sub>CAP</sub> if V<sub>CC</sub> is connected to ground.
- 10. These parameters are guaranteed but not tested.

SRAM Write Cycle #1 and #2

(V<sub>CC</sub> = 5.0 V ± 10%)<sup>[15]</sup>

| NO. | Symbols                               |                   |                 | Parameter                        | STK14C88-25 |     | STK14C88-35 |     | STK14C88-45 |     | Unit |
|-----|---------------------------------------|-------------------|-----------------|----------------------------------|-------------|-----|-------------|-----|-------------|-----|------|
|     | #1                                    | #2                | Alt.            |                                  | Min         | Max | Min         | Max | Min         | Max |      |
| 12  | t <sub>AVAV</sub>                     | t <sub>AVAV</sub> | t <sub>WC</sub> | Write cycle time                 | 25          | –   | 35          | –   | 45          | –   | ns   |
| 13  | t <sub>WLWH</sub>                     | t <sub>WLEH</sub> | t <sub>WP</sub> | Write pulse width                | 20          | –   | 25          | –   | 30          | –   | ns   |
| 14  | t <sub>ELWH</sub>                     | t <sub>ELEH</sub> | t <sub>CW</sub> | Chip enable to end of write      | 20          | –   | 25          | –   | 30          | –   | ns   |
| 15  | t <sub>DVWH</sub>                     | t <sub>DVEH</sub> | t <sub>DW</sub> | Data setup to end of write       | 10          | –   | 12          | –   | 15          | –   | ns   |
| 16  | t <sub>WHDX</sub>                     | t <sub>EHDX</sub> | t <sub>DH</sub> | Data hold after end of write     | 0           | –   | 0           | –   | 0           | –   | ns   |
| 17  | t <sub>AVWH</sub>                     | t <sub>AVEH</sub> | t <sub>AW</sub> | Address setup to end of write    | 20          | –   | 25          | –   | 30          | –   | ns   |
| 18  | t <sub>AVWL</sub>                     | t <sub>AVEL</sub> | t <sub>AS</sub> | Address setup to start of write  | 0           | –   | 0           | –   | 0           | –   | ns   |
| 19  | t <sub>WHAX</sub>                     | t <sub>EHAX</sub> | t <sub>WR</sub> | Address hold after end of write  | 0           | –   | 0           | –   | 0           | –   | ns   |
| 20  | t <sub>WLQZ</sub> <sup>[11, 12]</sup> |                   | t <sub>WZ</sub> | Write enable to output disable   | –           | 10  | –           | 13  | –           | 15  | ns   |
| 21  | t <sub>WHQX</sub>                     |                   | t <sub>OW</sub> | Output active after end of write | 5           | –   | 5           | –   | 5           | –   | ns   |

Figure 6. SRAM Write Cycle 1:  $\bar{W}$  Controlled [13, 14]

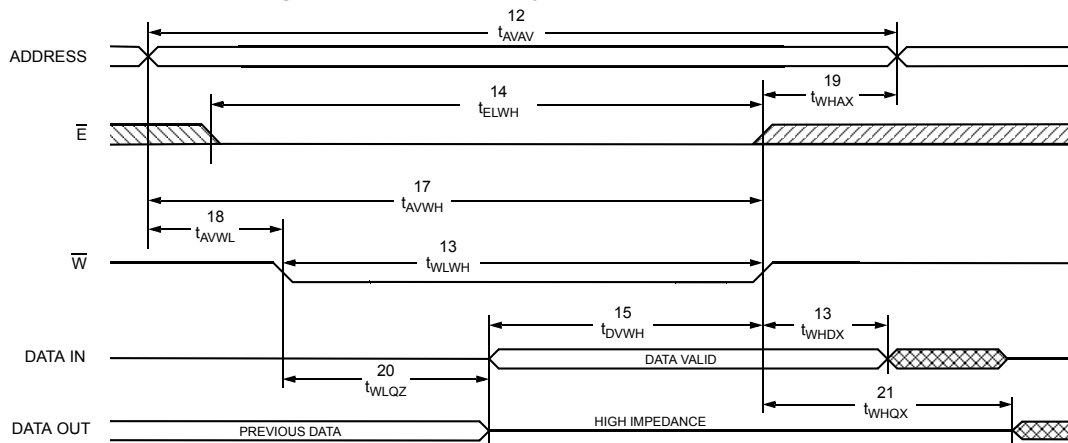
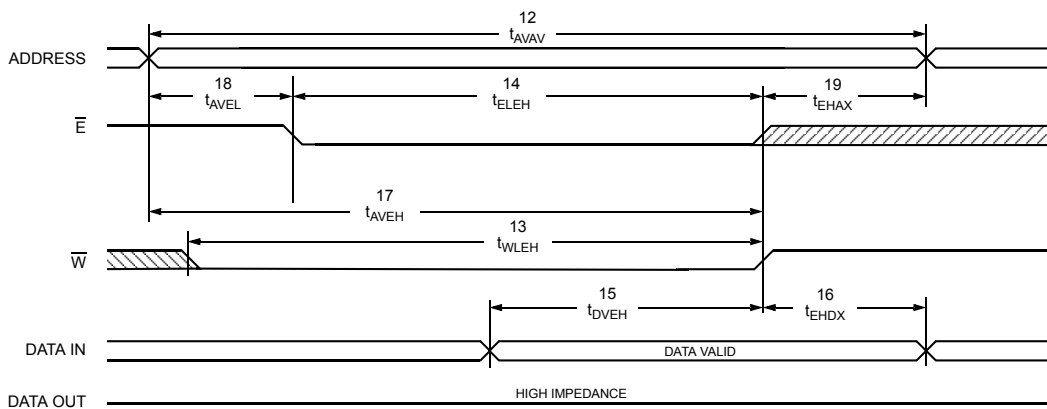

Figure 7. SRAM Write Cycle 2:  $\bar{E}$  Controlled [13, 14]



Notes

- 11. Measured ± 200 mV from steady state output voltage.
- 12. If  $\bar{W}$  is low when  $\bar{E}$  goes low, the outputs remain in the high impedance state.
- 13.  $\bar{E}$  or  $\bar{W}$  must be ≥ V<sub>IH</sub> during address transitions.
- 14. HSB must be high during SRAM write cycles.
- 15. V<sub>CC</sub> reference levels throughout this datasheet refer to V<sub>CC</sub> if that is where the power supply connection is made, or V<sub>CAP</sub> if V<sub>CC</sub> is connected to ground.

Hardware Mode Selection

| $\bar{E}$ | $\bar{W}$ | $\bar{HSB}$ | A <sub>13</sub> - A <sub>0</sub> (hex) | Mode              | I/O           | Power            | Notes |
|-----------|-----------|-------------|--|-------------------|---------------|------------------|-------|
| H         | X         | H           | X                                      | Not Selected      | Output High Z | Standby          | -     |
| L         | H         | H           | X                                      | Read SRAM         | Output Data   | Active           | 23    |
| L         | L         | H           | X                                      | Write SRAM        | Input Data    | Active           | -     |
| X         | X         | L           | X                                      | Nonvolatile STORE | Output High Z | I <sub>CC2</sub> | 16    |

Hardware STORE Cycle

| No. | Symbols              |                   | Parameter                           | STK14C88 |     | Units | Notes  |
|-----|----------------------|-------------------|-------------------------------------|----------|-----|-------|--------|
|     | Standard             | Alternate         |                                     | Min      | Max |       |        |
| 22  | t <sub>STORE</sub>   | t <sub>HLHZ</sub> | STORE cycle duration                | -        | 10  | ms    | 17     |
| 23  | t <sub>DELAY</sub>   | t <sub>HLQZ</sub> | Time allowed to complete SRAM cycle | 1        | -   | μs    | 17     |
| 24  | t <sub>RECOVER</sub> | t <sub>HHQX</sub> | Hardware STORE High to inhibit Off  | -        | 700 | ns    | 17, 18 |
| 25  | t <sub>HLHX</sub>    |                   | Hardware STORE pulse width          | 15       | -   | ns    | -      |
| 26  | t <sub>HLBL</sub>    |                   | Hardware STORE Low to STORE busy    | -        | 300 | ns    | -      |

Figure 8. Hardware STORE Cycle

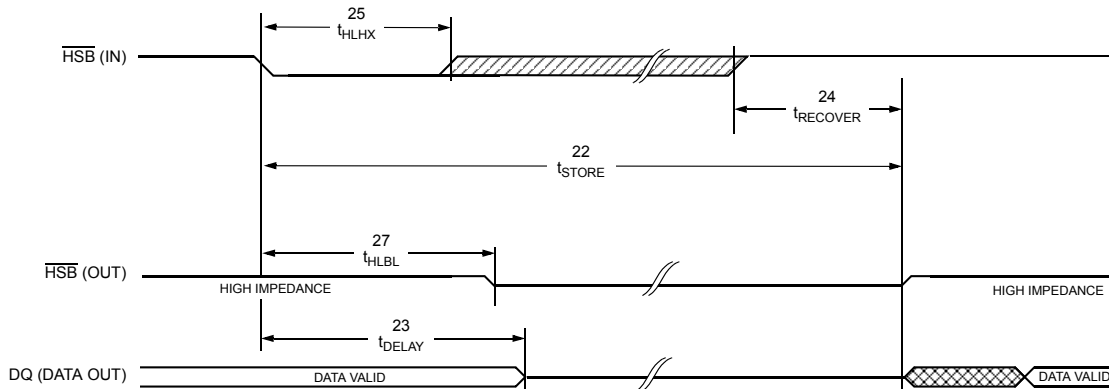

Notes

- 16. HSB STORE operation occurs only if an SRAM write is done since the last nonvolatile cycle. After the STORE (if any) completes, the part goes into standby mode, inhibiting all operations until HSB rises
- 17. E and G low, W high for output behavior.
- 18. t<sub>RECOVER</sub> is only applicable after t<sub>STORE</sub> is complete.



AutoStore/Power up RECALL

| NO. | Symbols       |            | Parameter                                       | STK14C88 |     | Unit    | Notes  |
|-----|---------------|------------|---|----------|-----|---------|--------|
|     | Standard      | Alt.       |   | Min      | Max |         |        |
| 27  | $t_{RESTORE}$ |            | Power up <i>RECALL</i> duration                 | –        | 550 | $\mu$ s | 19     |
| 28  | $t_{STORE}$   | $t_{HLHZ}$ | <i>STORE</i> cycle duration                     | –        | 10  | ms      | 17, 20 |
| 29  | $t_{VSBL}$    |            | Low voltage trigger ( $V_{SWITCH}$ ) to HSB Low | –        | 300 | ns      | 13     |
| 30  | $t_{DELAY}$   | $t_{BLQZ}$ | Time allowed to complete SRAM cycle             | 1        | –   | $\mu$ s | 17     |
| 31  | $V_{SWITCH}$  |            | Low voltage trigger level                       | 4.0      | 4.5 | V       | –      |
| 32  | $V_{RESET}$   |            | Low voltage reset level                         | –        | 3.6 | V       | –      |

Figure 9. AutoStore/POWER UP RECALL

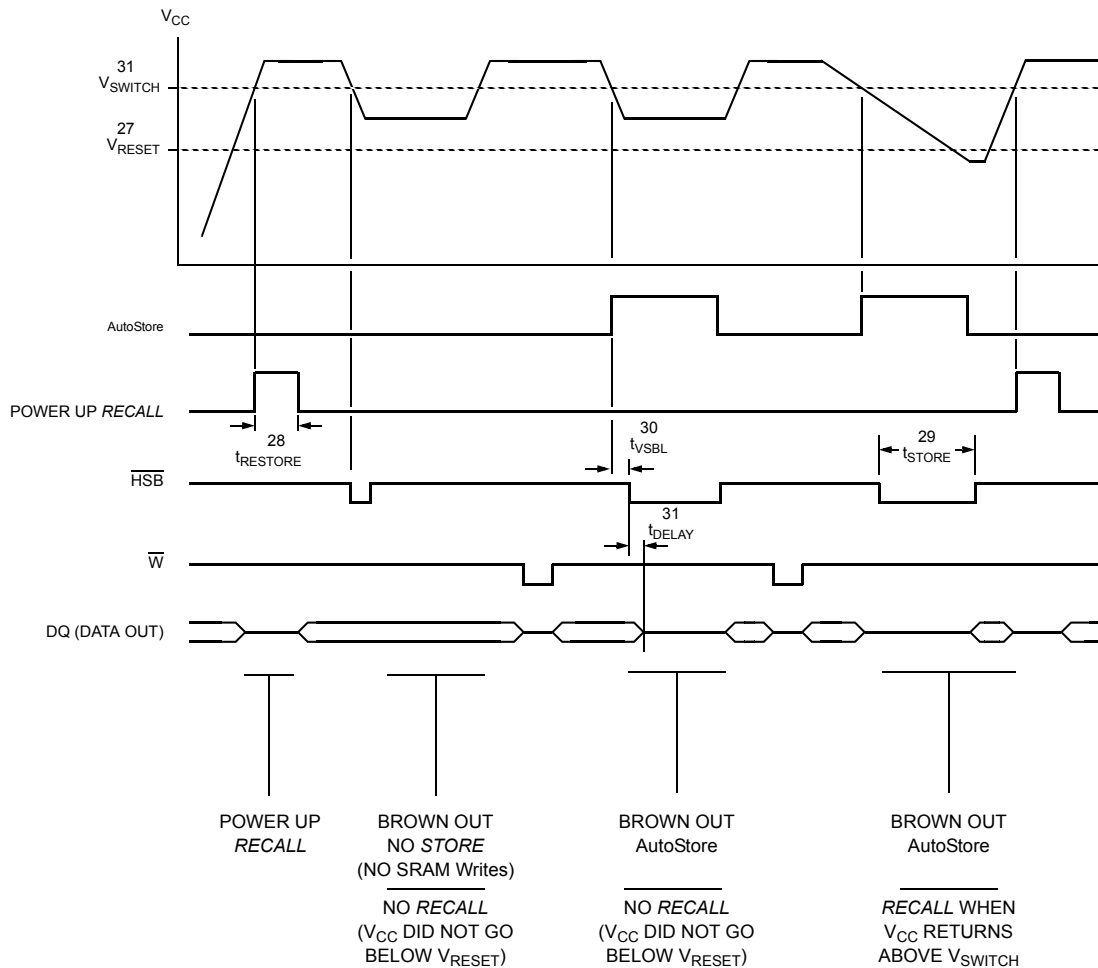

Notes

- 19.  $t_{RESTORE}$  starts from the time  $V_{CC}$  rises above  $V_{SWITCH}$ .
- 20. HSB is asserted low for 1 $\mu$ s when  $V_{CAP}$  drops through  $V_{SWITCH}$ . If an SRAM write has not taken place since the last nonvolatile cycle,  $\bar{HSB}$  is released and no *STORE* takes place.

**Software STORE/RECALL Mode Selection**

| $\bar{E}$ | $\bar{W}$ | A <sub>13</sub> - A <sub>0</sub> (hex) | Mode               | I/O           | POWER  | Notes          |
|-----------|-----------|--|--------------------|---------------|--------|----------------|
| L         | H         | 0E38                                   | Read SRAM          | Output Data   | Active | 17, 21, 22, 23 |
|           |           | 31C7                                   | Read SRAM          | Output Data   |        |                |
|           |           | 03E0                                   | Read SRAM          | Output Data   |        |                |
|           |           | 3C1F                                   | Read SRAM          | Output Data   |        |                |
|           |           | 303F                                   | Read SRAM          | Output Data   |        |                |
|           |           | 0FC0                                   | Nonvolatile STORE  | Output High Z |        |                |
| L         | H         | 0E38                                   | Read SRAM          | Output Data   | Active | 17, 21, 22, 23 |
|           |           | 31C7                                   | Read SRAM          | Output Data   |        |                |
|           |           | 03E0                                   | Read SRAM          | Output Data   |        |                |
|           |           | 3C1F                                   | Read SRAM          | Output Data   |        |                |
|           |           | 303F                                   | Read SRAM          | Output Data   |        |                |
|           |           | 0C63                                   | Nonvolatile RECALL | Output High Z |        |                |

**Software-Controlled STORE/RECALL Cycle**

| NO. | Symbols             |                 | Parameter                          | STK14C88-25 |     | STK14C88-35 |     | STK14C88-45 |     | Unit | Notes  |
|-----|---------------------|-----------------|------------------------------------|-------------|-----|-------------|-----|-------------|-----|------|--------|
|     | Standard            | Alt.            |                                    | Min         | Max | Min         | Max | Min         | Max |      |        |
| 33  | t <sub>AVAV</sub>   | t <sub>RC</sub> | STORE/RECALL initiation cycle time | 35          | –   | 45          | –   | 55          | –   | ns   | 17     |
| 34  | t <sub>AVEL</sub>   | t <sub>AS</sub> | Address setup time                 | 0           | –   | 0           | –   | 0           | –   | ns   | 24, 25 |
| 35  | t <sub>ELEH</sub>   | t <sub>CW</sub> | Clock pulse width                  | 25          | –   | 30          | –   | 35          | –   | ns   | 24, 25 |
| 36  | t <sub>ELAX</sub>   |                 | Address hold time                  | 20          | –   | 20          | –   | 20          | –   | ns   | 24, 25 |
| 37  | t <sub>RECALL</sub> |                 | RECALL duration                    | –           | 20  | –           | 20  | –           | 20  | μs   | –      |

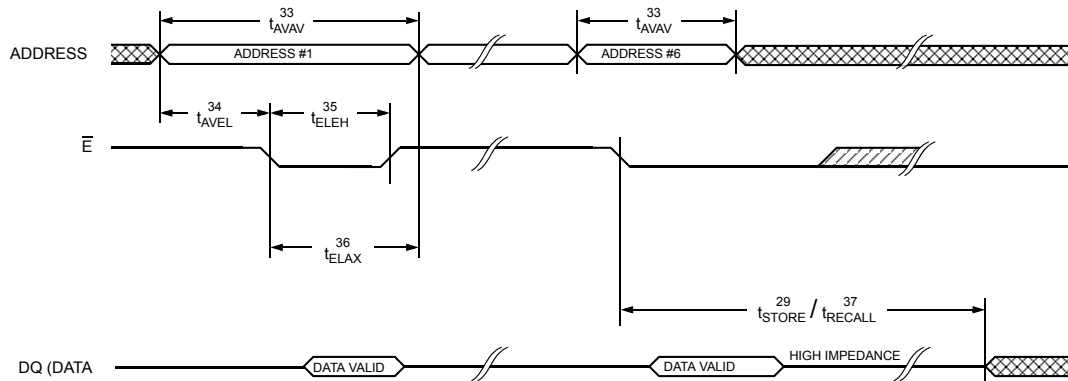
**Figure 10.  $\bar{E}$  Controlled Software STORE/RECALL Cycle [25]**

**Notes**

21. The six consecutive addresses must be in the order listed.  $\bar{W}$  must be high during all six consecutive  $\bar{E}$  controlled cycles to enable a nonvolatile cycle.
22. While there are 15 addresses on the STK14C88, only the lower 14 are used to control software modes.
23. I/O state assumes  $\bar{G} < V_{IL}$ . Activation of nonvolatile cycles does not depend on state of  $\bar{G}$ .
24. The software sequence is clocked on the falling edge of  $\bar{E}$  controlled reads without involving  $\bar{G}$  (double clocking aborts the sequence).
25. The six consecutive addresses must be in the order listed in the Software STORE/RECALL Mode Selection Table: (0E38, 31C7, 03E0, 3C1F, 303F, 0FC0) for a STORE cycle or (0E38, 31C7, 03E0, 3C1F, 303F, 0C63) for a RECALL cycle.  $\bar{W}$  must be high during all six consecutive cycles.

## nvSRAM Operation

The STK14C88 has two separate modes of operation: SRAM mode and nonvolatile mode. In SRAM mode, the memory operates as a standard-fast SRAM. In nonvolatile mode, data is transferred from SRAM to nonvolatile elements (the STORE operation) or from nonvolatile elements to SRAM (the RECALL operation). In this mode, SRAM functions are disabled.

## Noise Considerations

The STK14C88 is a high-speed memory and so must have a high frequency bypass capacitor of approximately 0.1  $\mu$ F connected between  $V_{CAP}$  and  $V_{SS}$ , using leads and traces that are as short as possible. As with all high-speed CMOS ICs, careful routing of power, ground, and signals helps to prevent noise problems.

## SRAM Read

The STK14C88 performs a read cycle whenever  $\bar{E}$  and  $\bar{G}$  are low, and  $\bar{W}$  and HSB are high. The address specified on pins  $A_{0-14}$  determines which of the 32,768 data bytes are accessed. When the read is initiated by an address transition, the outputs are valid after a delay of  $t_{AVQV}$  (Read cycle #1). If the read is initiated by  $\bar{E}$  or  $\bar{G}$ , the outputs are valid at  $t_{ELQV}$  or at  $t_{GLQV}$ , whichever is later (Read cycle #2). The data outputs repeatedly respond to address changes within the  $t_{AVQV}$  access time without the need for transitions on any control input pins, and remain valid until another address change or until  $\bar{E}$  or  $\bar{G}$  is brought high, or  $\bar{W}$  or HSB is brought low.

## SRAM Write

A write cycle is performed whenever  $\bar{E}$  and  $\bar{W}$  are low, and HSB is high. The address inputs must be stable prior to entering the write cycle and must remain stable until either  $\bar{E}$  or  $\bar{W}$  goes high at the end of the cycle. The data on the common I/O pins  $DQ_{0-7}$  are written into the memory if it is valid  $t_{DVWH}$  before the end of a  $\bar{W}$  controlled write or  $t_{DVEH}$  before the end of an  $\bar{E}$  controlled write.

Keep  $\bar{G}$  high during the entire write cycle to avoid data bus contention on common I/O lines. If  $\bar{G}$  is left low, internal circuitry turns off the output buffers  $t_{WLQZ}$  after  $\bar{W}$  goes low.

## Power Up RECALL

During power up, or after any low-power condition ( $V_{CAP} < V_{RESET}$ ), an internal RECALL request is latched. When  $V_{CAP}$  again exceeds the sense voltage of  $V_{SWITCH}$ , a RECALL cycle is automatically initiated and takes  $t_{RESTORE}$  to complete.

If the STK14C88 is in a write state at the end of power-up RECALL, the SRAM data will be corrupted. To avoid this, a 10 k $\Omega$  resistor should be connected either between  $\bar{W}$  and system  $V_{CC}$  or between  $\bar{E}$  and system  $V_{CC}$ .

## Software Nonvolatile STORE

The STK14C88 software STORE cycle is initiated by executing sequential  $\bar{E}$  controlled read cycles from six specific address locations. During the STORE cycle an erase of the previous nonvolatile data is first performed, followed by a program of the nonvolatile elements. The program operation copies the SRAM data into nonvolatile memory. When a STORE cycle is initiated, further input and output are disabled until the cycle is completed.

Because a sequence of reads from specific addresses is used for STORE initiation, it is important that no other read or write accesses intervene in the sequence, or the sequence will be aborted and no STORE or RECALL takes place.

To initiate the software STORE cycle, the following read sequence must be performed:

1. Read address 0E38 (hex) Valid READ
2. Read address 31C7 (hex) Valid READ
3. Read address 03E0 (hex) Valid READ
4. Read address 3C1F (hex) Valid READ
5. Read address 303F (hex) Valid READ
6. Read address 0FC0 (hex) Initiate STORE cycle

The software sequence must be clocked with  $\bar{E}$  controlled reads.

After the sixth address in the sequence is entered, the STORE cycle commences and the chip is disabled. Use only read cycles in the sequence, although it is not necessary that  $\bar{G}$  be low for the sequence to be valid. After the  $t_{STORE}$  cycle time is fulfilled, the SRAM is again activated for read and write operation.

## Software Nonvolatile RECALL

A software RECALL cycle is initiated with a sequence of read operations in a manner similar to the software STORE initiation. To initiate the RECALL cycle, the following sequence of  $\bar{E}$  controlled read operations must be performed:

1. Read address 0E38 (hex) Valid READ
2. Read address 31C7 (hex) Valid READ
3. Read address 03E0 (hex) Valid READ
4. Read address 3C1F (hex) Valid READ
5. Read address 303F (hex) Valid READ
6. Read address 0C63 (hex) Initiate RECALL cycle

Internally, RECALL is a two step procedure. First, the SRAM data is cleared, and second, the nonvolatile information is transferred into the SRAM cells. After the  $t_{RECALL}$  cycle time, the SRAM is again ready for read and write operations. The RECALL operation in no way alters the data in the nonvolatile elements. The nonvolatile data can be recalled an unlimited number of times.

## AutoStore Mode

The STK14C88 can be powered in one of three modes.

During normal AutoStore operation, the STK14C88 draws current from  $V_{CC}$  to charge a capacitor connected to the  $V_{CAP}$  pin. This stored charge is used by the chip to perform a single STORE operation. After power up, when the voltage on the  $V_{CAP}$  pin drops below  $V_{SWITCH}$ , the part automatically disconnects the  $V_{CAP}$  pin from  $V_{CC}$  and initiate a STORE operation.

Figure 11 shows the proper connection of capacitors for automatic store operation. A charge storage capacitor having a capacity of between 68  $\mu\text{F}$  and 220  $\mu\text{F}$  ( $\pm 20\%$ ) rated at 6 V should be provided.

In system power mode, both  $V_{CC}$  and  $V_{CAP}$  are connected to the + 5 V power supply without the 68  $\mu\text{F}$  capacitor. In this mode, the AutoStore function of the STK14C88 operates on the stored system charge as power goes down. The user must, however, guarantee that  $V_{CC}$  does not drop below 3.6 V during the 10 ms STORE cycle.

If an automatic STORE on power loss is not required, then  $V_{CC}$  can be tied to ground and + 5 V applied to  $V_{CAP}$  (Figure 12). This is the AutoStore Inhibit mode, in which the AutoStore function is disabled. If the STK14C88 is operated in this configuration, references to  $V_{CC}$  should be changed to  $V_{CAP}$  throughout this datasheet. In this mode, STORE operations may be triggered through software control or the HSB pin. To enable or disable AutoStore using an I/O port pin, see Preventing STORES on page 13.

To prevent unneeded STORE operations, automatic STOREs and those initiated by externally driving HSB low are ignored unless at least one write operation has taken place since the most recent STORE or RECALL cycle. Software initiated STORE cycles are performed regardless of whether a write operation has taken place.

If the power supply drops faster than 20 ms/volt before  $V_{CC}$  reaches  $V_{SWITCH}$ , then a 2.2  $\Omega$  resistor should be inserted between  $V_{CC}$  and the system supply to avoid momentary excess of current between  $V_{CC}$  and  $V_{CAP}$ .

Figure 11. AutoStore Mode

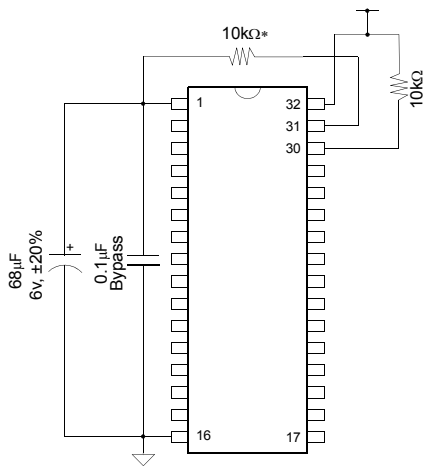

### AutoStore INHIBIT Mode

If an automatic STORE on power loss is not required, then  $V_{CC}$  can be tied to ground and system power applied to  $V_{CAP}$  (Figure 12). This is the AutoStore Inhibit mode, in which the AutoStore function is disabled. If the STK14C88 is operated in this configuration, references to  $V_{CC}$  should be changed to  $V_{CAP}$  throughout this data sheet. In this mode, STORE operations may be triggered through software control. It is not permissible to change between these three options “on the fly.”

Figure 12. AutoStore Inhibit Mode

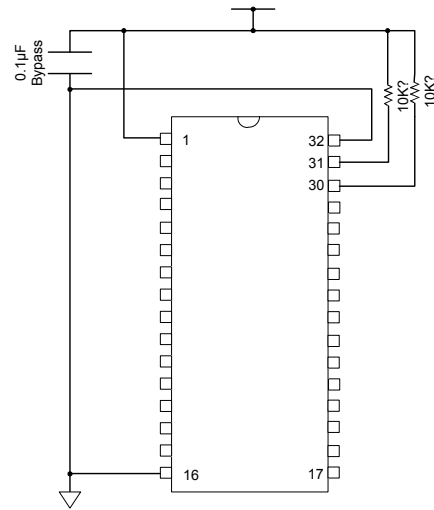

### HSB Operation

The STK14C88 provides the  $\overline{\text{HSB}}$  pin for controlling and acknowledging the STORE operations. The HSB pin can be used to request a hardware STORE cycle. When the HSB pin is driven low, the STK14C88 conditionally initiates a STORE operation after  $t_{\text{DELAY}}$ ; an actual STORE cycle only begins if a write to the SRAM took place since the last STORE or RECALL cycle. The HSB pin has a very resistive pull-up and is internally driven low to indicate a busy condition when the STORE (initiated by any means) is in progress. Pull up this pin with an external 10 k $\Omega$  resistor to  $V_{CAP}$  if HSB is used as a driver.

SRAM read and write operations that are in progress when  $\overline{\text{HSB}}$  is driven low by any means are given time to complete before the STORE operation is initiated. After HSB goes low, the STK14C88 continues SRAM operations for  $t_{\text{DELAY}}$ . During  $t_{\text{DELAY}}$ , multiple SRAM read operations may take place. If a write is in progress when  $\overline{\text{HSB}}$  is pulled low it is allowed a time,  $t_{\text{DELAY}}$ , to complete. However, any SRAM write cycles requested after HSB goes low are inhibited until HSB returns high.

The HSB pin can be used to synchronize multiple STK14C88s while using a single larger capacitor. To operate in this mode, the HSB pin should be connected together to the HSB pins from the other STK14C88s. An external pull-up resistor to + 5 V is required because HSB acts as an open drain pull-down. The  $V_{CAP}$  pins from the other STK14C88 parts can be tied together and share a single capacitor. The capacitor size must be scaled by the number of devices connected to it. When any one of the STK14C88s detects a power loss and asserts HSB, the common HSB pin causes all parts to request a STORE cycle (a STORE takes place in those STK14C88s that are written since the last nonvolatile cycle).

During any STORE operation, regardless of how it was initiated, the STK14C88 continues to drive the  $\overline{\text{HSB}}$  pin low, releasing it only when the STORE is complete. Upon completion of the STORE operation the STK14C88 remains disabled until the HSB pin returns high.

If  $\overline{\text{HSB}}$  is not used, leave it unconnected.

## Best Practices

nvSRAM products have been used effectively for over 15 years. While ease-of-use is one of the product’s main system values, experience gained working with hundreds of applications has resulted in the following suggestions as best practices:

- The nonvolatile cells in an nvSRAM are programmed on the test floor during final test and quality assurance. Incoming inspection routines at customer or contract manufacturer’s sites sometimes reprogram these values. Final NV patterns are typically repeating patterns of AA, 55, 00, FF, A5, or 5A. The end product’s firmware should not assume an NV array is in a set programmed state. Routines that check memory content values to determine first time system configuration, cold or warm boot status, and so on, should always program a unique NV pattern (for example, complex 4-byte pattern of 46 E6 49 53 hex or more random bytes) as part of the final system manufacturing test to ensure these system routines work consistently.
- Power-up boot firmware routines should rewrite the nvSRAM into the desired state (such as autostore enabled). While the nvSRAM is shipped in a preset state, best practice is to again rewrite the nvSRAM into the desired state as a safeguard against events that might flip the bit inadvertently (program bugs, incoming inspection routines, and so on).
- The  $V_{CAP}$  value specified in this datasheet includes a minimum and a maximum value size. Best practice is to meet this requirement and not exceed the max  $V_{CAP}$  value because the nvSRAM internal algorithm calculates  $V_{CAP}$  charge time based on this max  $V_{CAP}$  value. Customers who want to use a larger  $V_{CAP}$  value to make sure there is extra store charge and store time should discuss their  $V_{CAP}$  size selection with Cypress to understand any impact on the  $V_{CAP}$  voltage level at the end of a  $t_{RECALL}$  period.

## Preventing STORES

The STORE function can be disabled on the fly by holding  $\overline{HSB}$  high with a driver capable of sourcing 30 mA at a  $V_{OH}$  of at least 2.2 V, because it must overpower the internal pull down device that drives  $\overline{HSB}$  low for 20 ms at the onset of a STORE. When the STK14C88 is connected for AutoStore operation (system  $V_{CC}$  connected to  $V_{CC}$  and a 68 uF capacitor on  $V_{CAP}$ ) and  $V_{CC}$  crosses  $V_{SWITCH}$  on the way down, the STK14C88 attempts to pull  $\overline{HSB}$  low; if  $\overline{HSB}$  does not actually get below  $V_{IL}$ , the part stops trying to pull  $\overline{HSB}$  low and abort the STORE attempt.

## Hardware Protect

The STK14C88 offers hardware protection against inadvertent STORE operation and SRAM writes during low-voltage conditions. When  $V_{CAP} < V_{SWITCH}$ , all externally initiated STORE operations and SRAM writes are inhibited.

AutoStore can be completely disabled by tying  $V_{CC}$  to ground and applying + 5 V to  $V_{CAP}$ . This is the AutoStore Inhibit mode; in this mode STOREs are only initiated by explicit request using either the software sequence or the  $\overline{HSB}$  pin.

## Low Average Active Power

The STK14C88 draws significantly less current when it is cycled at times longer than 50 ns. Figure 13 shows the relationship between  $I_{CC}$  and read cycle time. Worst case current consumption is shown for both CMOS and TTL input levels (commercial temperature range,  $V_{CC} = 5.5$  V, 100% duty cycle on chip enable). Figure 14 shows the same relationship for write cycles. If the chip enable duty cycle is less than 100%, only standby current is drawn when the chip is disabled. The overall average current drawn by the STK14C88 depends on the following items:

- CMOS versus TTL input levels
- The duty cycle of chip enable
- The overall cycle rate for accesses
- The ratio of reads to writes
- The operating temperature
- The  $V_{CC}$  level
- I/O loading.

Figure 13.  $I_{CC}$  (max) Reads

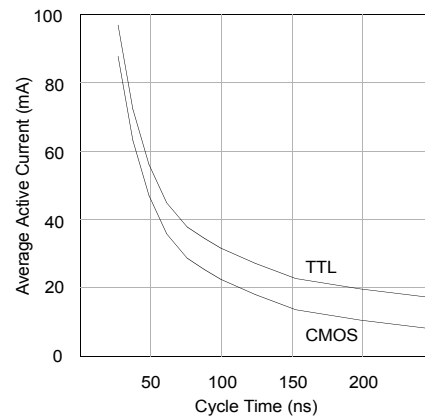
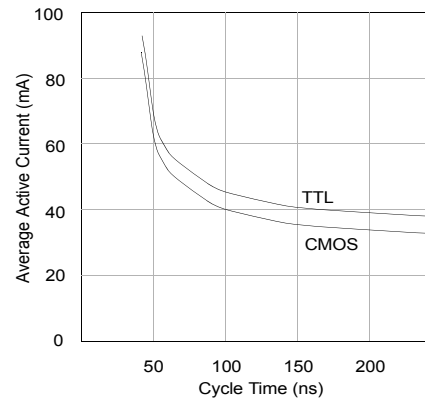

Figure 14.  $I_{CC}$  (max) Writes



**Ordering Information**

These parts are not recommended for new designs.

| Part Number    | Description                              | Access Times | Temperature |
|----------------|--|--------------|-------------|
| STK14C88-C45I  | 5-V 32 K x 8 AutoStore nvSRAM CDIP32-300 | 45 ns        | Industrial  |
| STK14C88-5L35M | 5-V 32 K x 8 AutoStore nvSRAM LCC32-300  | 35 ns        | Military    |
| STK14C88-5L45M | 5-V 32 K x 8 AutoStore nvSRAM LCC32-300  | 45 ns        | Military    |
| STK14C88-5C35M | 5-V 32 K x 8 AutoStore nvSRAM CDIP32-300 | 35 ns        | Military    |
| STK14C88-5K45M | 5-V 32 K x 8 AutoStore nvSRAM CDIP32-300 | 45 ns        | Military    |

**Commercial and Industrial Ordering Information**

**STK14C88 - N F 45 I TR**

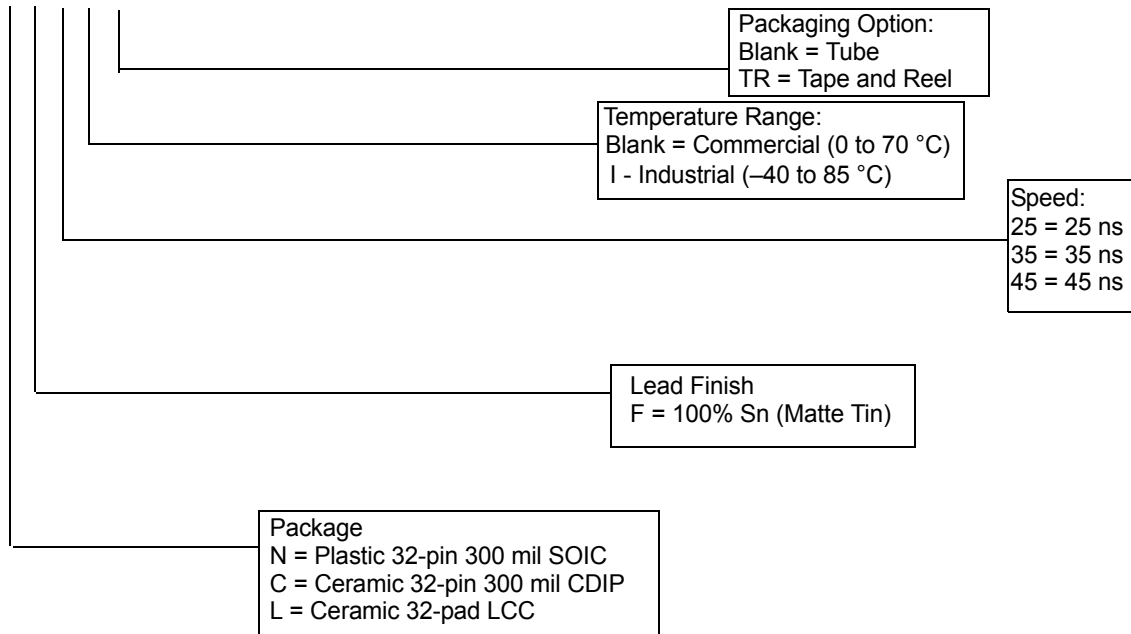

Military Ordering Information

STK14C88 - 5 C 45 M

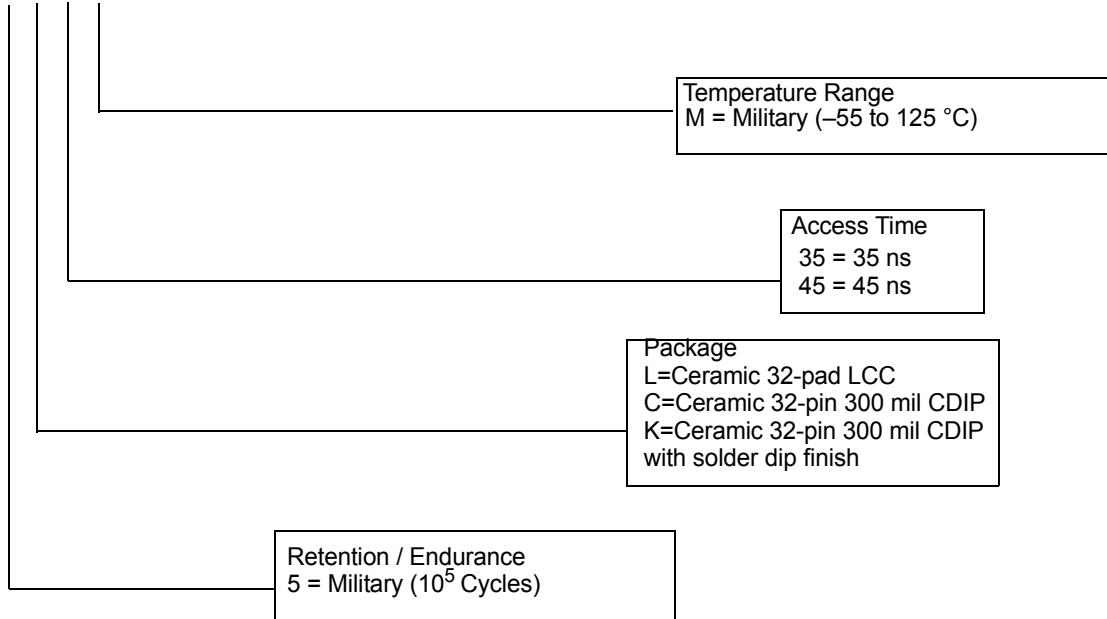

Package Diagrams

Figure 15. 32-Pin 300 mil SOIC Gull Wing (51-85127)

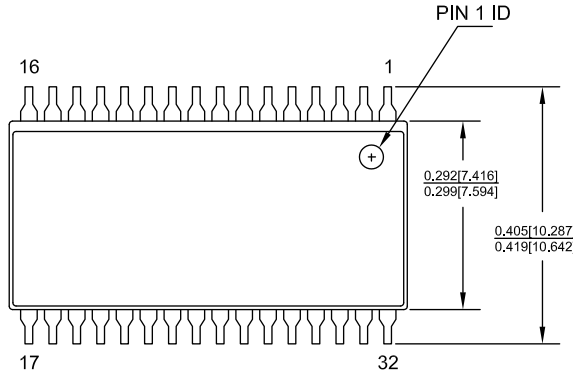

DIMENSIONS IN INCHES[MM]      MIN.  
MAX.

REFERENCE JEDEC MO-119

| PART # |                |
|--------|----------------|
| S32.3  | STANDARD PKG.  |
| SZ32.3 | LEAD FREE PKG. |

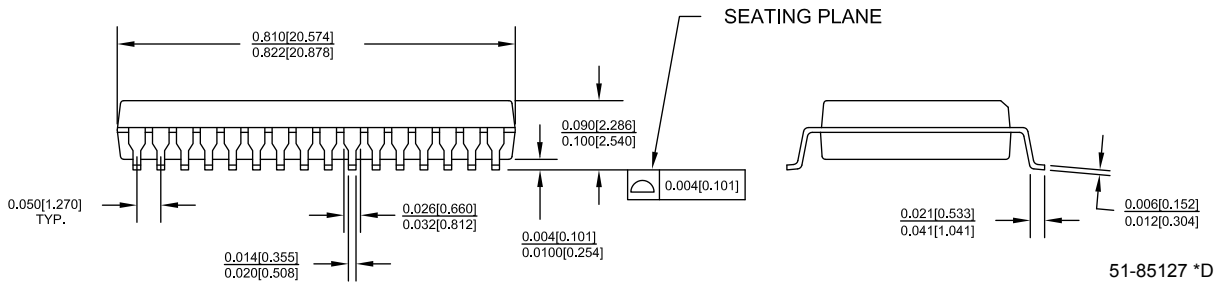



Package Diagrams (continued)

Figure 16. 32-Pin 300 mil Side Braze DIL (001-51694)

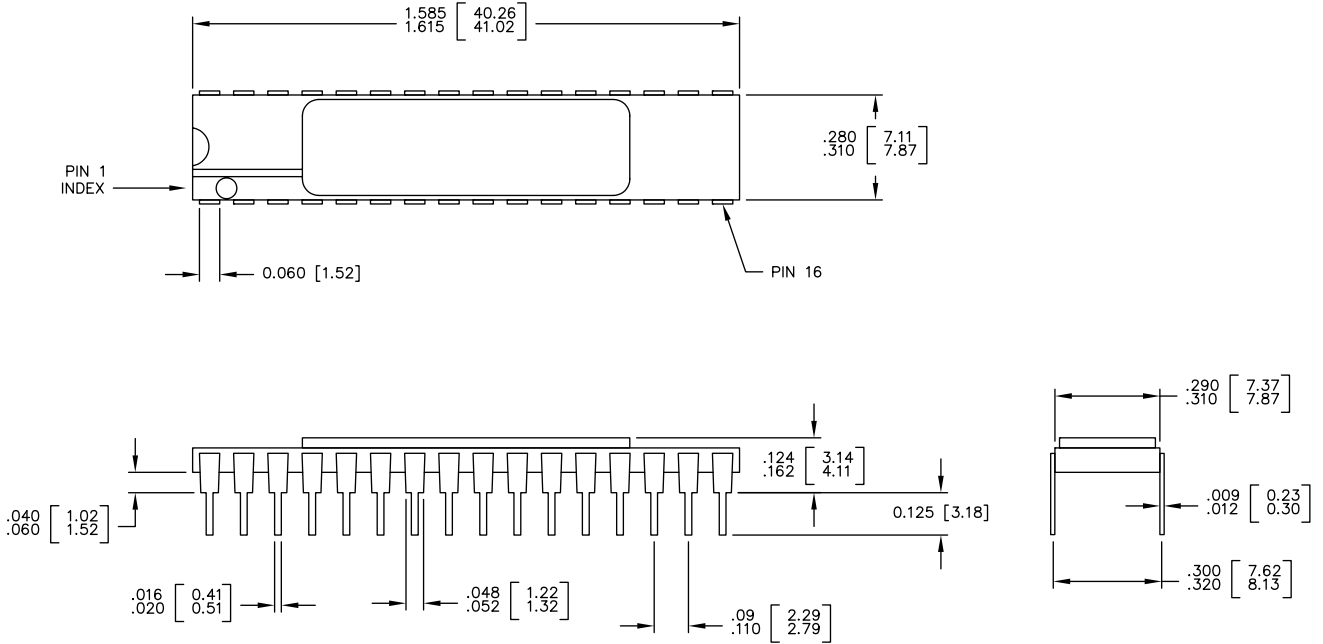

1. ALL DIMENSIONS ARE IN INCHES AND MILLIMETERS (MIN/MAX)
2. PACKAGE WEIGHT: See Cypress Package Material Declaration Datasheet (PMDD) posted on the Cypress Web
3. JEDEC REFERENCE : MO-058

001-51694 \*C

Package Diagrams (continued)

Figure 17. 32-Pad (450-Mil) LCC (51-80068)

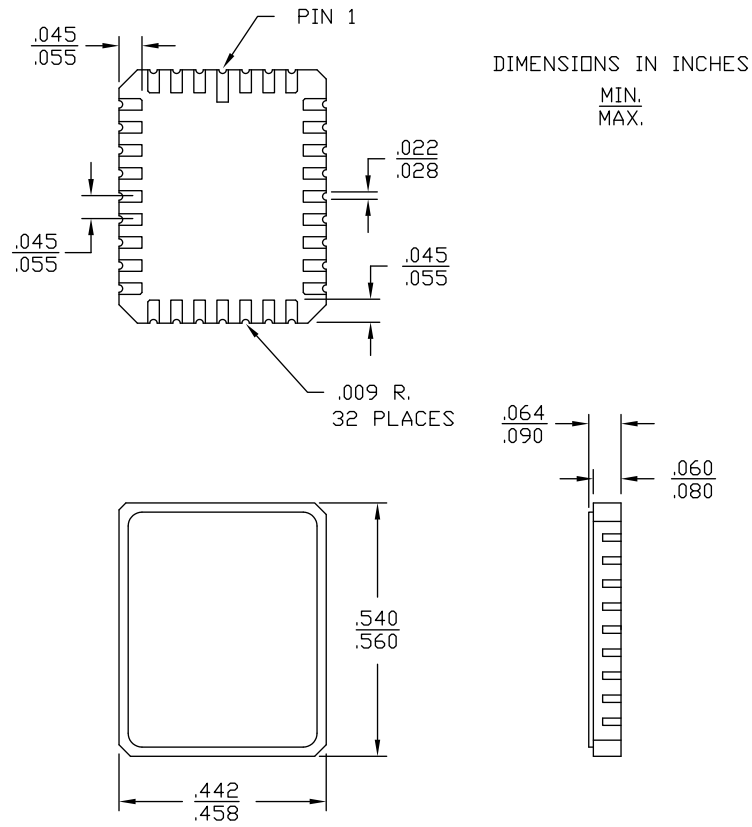

51-80068 \*C

**Acronyms**

| Acronym | Description                             |
|---------|---|
| nvSRAM  | nonvolatile static random access memory |
| SSOP    | shrink small-outline package            |
| SOIC    | small-outline integrated circuit        |
| TSOP II | thin small outline package              |
| FBGA    | fine-pitch ball grid array              |
| RoHS    | restriction of hazardous substances     |
| I/O     | input/output                            |
| CMOS    | complementary metal oxide semiconductor |
| EIA     | electronic industries alliance          |
| RWI     | read and write inhibited                |

**Document Conventions**

**Units of Measure**

| Symbol | Unit of Measure |
|--------|-----------------|
| °C     | degrees Celsius |
| Hz     | hertz           |
| kbit   | 1024 bits       |
| kHz    | kilohertz       |
| kΩ     | kilohm          |
| μA     | microampere     |
| mA     | milliampere     |
| μF     | microfarad      |
| MHz    | megahertz       |
| μs     | microsecond     |
| ms     | millisecond     |
| ns     | nanosecond      |
| pF     | picofarad       |
| V      | volt            |
| Ω      | ohm             |
| W      | watt            |

Document History Page

| Document Title: STK14C88 32 K x 8 AutoStore nvSRAM<br>Document Number: 001-52038 |         |                 |                 |   |
|--|---------|-----------------|-----------------|---|
| Rev.   | ECN No. | Orig. of Change | Submission Date | Description of Change   |
| **   | 2668632 | GVCH            | 03/04/2009      | New data sheet  |
| *A   | 2718242 | GVCH            | 06/12/09        | Ordering Information description: Corrected typo  |
| *B   | 2821358 | GVCH            | 12/04/2009      | Added Note in Ordering Information mentioning that these parts are not recommended for new designs.<br>Added "Not recommended for New Designs" watermark in the PDF.<br>Added Contents on page 2.   |
| *C   | 3210316 | GVCH            | 03/30/2011      | Moved contents of page 14 to page 10.<br>Updated package diagram.<br>Added Acronyms and Document Conventions.   |
| *D   | 3530341 | GVCH            | 02/20/2012      | Removed inactive parts (STK14C88-NF35, STK14C88-NF25TR, STK14C88-NF35TR, STK14C88-NF45TR, STK14C88-NF35I, STK14C88-NF25ITR, STK14C88-NF35ITR and STK14C88-NF45ITR) from <a href="#">Ordering Information</a> table.<br>Updated <a href="#">Package Diagrams</a> 51-85127 (from Rev *B to *C) and 51-80068 (from Rev *A to *B) |
| *E   | 4579541 | GVCH            | 11/25/2014      | Added documentation related hyperlink in page 1<br>Removed pruned parts - STK14C88-NF25, STK14C88-NF45, STK14C88-NF25I, STK14C88-NF45I, STK14C88-5C45M and STK14C88-5K35M<br>Updated package diagrams from 001-51694 *A to 001-51694 *B and 51-80068 *B to 51-80068 *C  |
| *F   | 4706588 | GVCH            | 03/31/2015      | Updated package diagram from 001-51694 *B to 001-51694 *C<br>Updated package diagram from 51-85127 *C to 51-85127 *D  |

## Sales, Solutions, and Legal Information

### Worldwide Sales and Design Support

Cypress maintains a worldwide network of offices, solution centers, manufacturer's representatives, and distributors. To find the office closest to you, visit us at [Cypress Locations](#).

### Products

|                          |  |
|--------------------------|--|
| Automotive               | <a href="http://cypress.com/go/automotive">cypress.com/go/automotive</a>   |
| Clocks & Buffers         | <a href="http://cypress.com/go/clocks">cypress.com/go/clocks</a>   |
| Interface                | <a href="http://cypress.com/go/interface">cypress.com/go/interface</a>   |
| Lighting & Power Control | <a href="http://cypress.com/go/powerpsoc">cypress.com/go/powerpsoc</a><br><a href="http://cypress.com/go/plc">cypress.com/go/plc</a> |
| Memory                   | <a href="http://cypress.com/go/memory">cypress.com/go/memory</a>   |
| Optical & Image Sensing  | <a href="http://cypress.com/go/image">cypress.com/go/image</a>   |
| PSoC                     | <a href="http://cypress.com/go/psoc">cypress.com/go/psoc</a>   |
| Touch Sensing            | <a href="http://cypress.com/go/touch">cypress.com/go/touch</a>   |
| USB Controllers          | <a href="http://cypress.com/go/USB">cypress.com/go/USB</a>   |
| Wireless/RF              | <a href="http://cypress.com/go/wireless">cypress.com/go/wireless</a>   |

### PSoC Solutions

[psoc.cypress.com/solutions](http://psoc.cypress.com/solutions)  
PSoC 1 | PSoC 3 | PSoC 5

---

© Cypress Semiconductor Corporation, 2009-2015. The information contained herein is subject to change without notice. Cypress Semiconductor Corporation assumes no responsibility for the use of any circuitry other than circuitry embodied in a Cypress product. Nor does it convey or imply any license under patent or other rights. Cypress products are not warranted nor intended to be used for medical, life support, life saving, critical control or safety applications, unless pursuant to an express written agreement with Cypress. Furthermore, Cypress does not authorize its products for use as critical components in life-support systems where a malfunction or failure may reasonably be expected to result in significant injury to the user. The inclusion of Cypress products in life-support systems application implies that the manufacturer assumes all risk of such use and in doing so indemnifies Cypress against all charges.

Any Source Code (software and/or firmware) is owned by Cypress Semiconductor Corporation (Cypress) and is protected by and subject to worldwide patent protection (United States and foreign), United States copyright laws and international treaty provisions. Cypress hereby grants to licensee a personal, non-exclusive, non-transferable license to copy, use, modify, create derivative works of, and compile the Cypress Source Code and derivative works for the sole purpose of creating custom software and or firmware in support of licensee product to be used only in conjunction with a Cypress integrated circuit as specified in the applicable agreement. Any reproduction, modification, translation, compilation, or representation of this Source Code except as specified above is prohibited without the express written permission of Cypress.

Disclaimer: CYPRESS MAKES NO WARRANTY OF ANY KIND, EXPRESS OR IMPLIED, WITH REGARD TO THIS MATERIAL, INCLUDING, BUT NOT LIMITED TO, THE IMPLIED WARRANTIES OF MERCHANTABILITY AND FITNESS FOR A PARTICULAR PURPOSE. Cypress reserves the right to make changes without further notice to the materials described herein. Cypress does not assume any liability arising out of the application or use of any product or circuit described herein. Cypress does not authorize its products for use as critical components in life-support systems where a malfunction or failure may reasonably be expected to result in significant injury to the user. The inclusion of Cypress' product in a life-support systems application implies that the manufacturer assumes all risk of such use and in doing so indemnifies Cypress against all charges.

Use may be limited by and subject to the applicable Cypress software license agreement.