

# Level Sensor Transducer

**Part Number: H2KLPY11000600**



### 1. Introduction:

Unictron's LPY1 ultrasonic transducer is designed to cover 1MHz frequency. The transducer works as a signal transmitting and receiving unit. The transducer works with gelpad (or dry coupling) is particularly for non-invasive bottom-up type liquid level sensors for measuring the level of liquid in a plastic container or vessel.



### 2. Part Number: H2KLPY11000600

### 3. Electrical Characteristics:

3.1	Operation Frequency	1	MHz
3.2	Echo Voltage(refer to Item 4)	>50	mV
3.3	Capacitance at 1 kHz	1250 ± 20%	pF
3.4	Maximum Driving Voltage	50	Vpp

Measured at temperature 25±5°, 40~70%RH  
Instrument: Keysight E4990A

### 4. Standard Testing

Sensitivity measurement

Liquid level: 10cm (olive oil) / container: HDPE

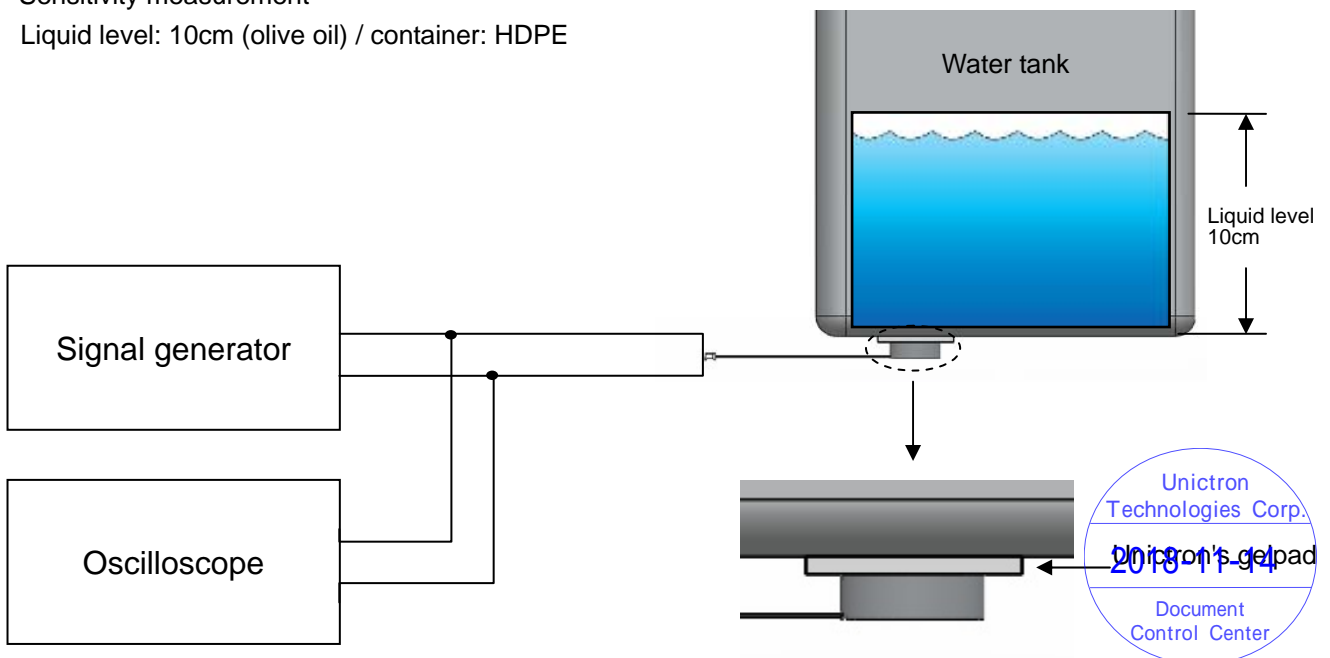

TOLERANCES (UNLESS SPECIFIED OTHERWISE) X = ±            X.X = ±            X.XX =		 詠業科技股份有限公司 Unictron Technologies Corporation Website: www.unictron.com		
ANGLES = ±            HOLE DIA = ±				
SCALE : free	UNIT : mm	THIS SPECIFICATION IS THE PROPERTY OF UNICTRON TECHNOLOGIES CORPORATION AND MAY NOT BE REPRODUCED OR USED IN WHOLE OR IN PART WITHOUT WRITTEN PERMISSION FROM UNICTRON.		
DRAWN By : Ray Hsieh	CHECKED BY: Hank Lee			
DESIGNED BY : KK Ting	APPROVED BY : Hank Lee			
TITLE : Level Sensor Transducer		DOCUMENT NO.	H2KLPY11000600	REV. A

Drive Signal ( $V_{Driving}$ ): 1MHz 3.3v 20 pules, Drive interval: 10ms  
 Echo Signal ( $V_{Echo}$ ) : For 10cm olive oil level, echo signal appear around at 140us

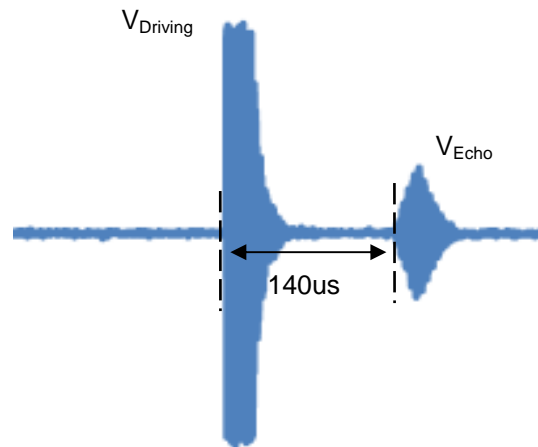

## 5. Operating and Storage conditions

Operating:

Operating Temperature: -20°C to + 70°C

Maximum driving voltage: 50 Vp-p

Storage:

Storage Temperature: -30°C to + 80°C

Relative Humidity: 40 - 80%

Storage area shall avoid sulfur materials. Sulfur will cause corrosion of electrodes connecting the piezo element



TOLERANCES (UNLESS SPECIFIED OTHERWISE) $X = \pm$ $X.X = \pm$ $X.XX =$ <b>ANGLES = <math>\pm</math></b> <b>HOLE DIA = <math>\pm</math></b>		 詠業科技股份有限公司 Unictron Technologies Corporation Website: www.unictron.com		
SCALE : free	UNIT : mm	THIS SPECIFICATION IS THE PROPERTY OF UNICTRON TECHNOLOGIES CORPORATION AND MAY NOT BE REPRODUCED OR USED IN WHOLE OR IN PART WITHOUT WRITTEN PERMISSION FROM UNICTRON.		
DRAWN By : Ray Hsieh	CHECKED BY: Hank Lee			
DESIGNED BY : KK Ting	APPROVED BY : Hank Lee			
TITLE : Level Sensor Transducer		DOCUMENT NO.	H2KLPY11000600	REV. A

**6. Dimensions:**

**Unit: mm**

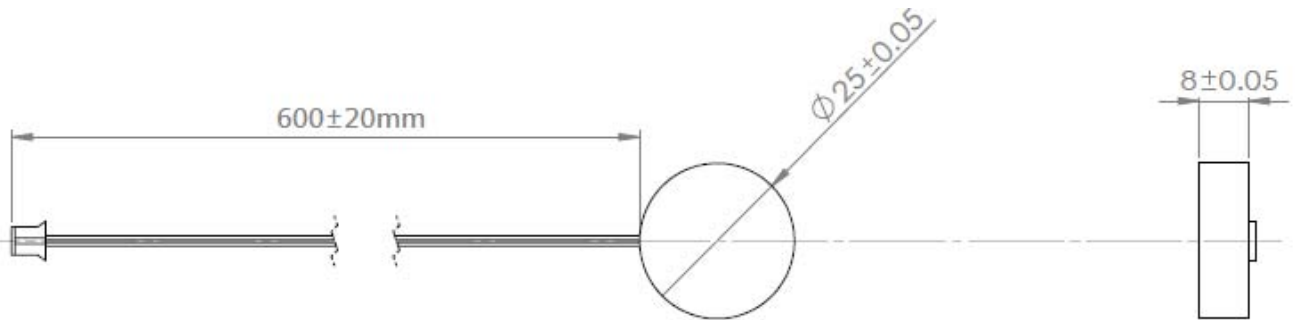

4.1	Housing	Aluminum alloy
4.2	Housing size	OD:25mm/H:8mm
4.3	Cable length (UL10368 AWG30)	600 ± 20mm
4.4	Connector	2 Pin/Pitch 2.54



TOLERANCES (UNLESS SPECIFIED OTHERWISE) X = ±      X.X = ±      X.XX = ANGLES = ±      HOLE DIA = ±		 詠業科技股份有限公司 Unictron Technologies Corporation Website: www.unictron.com		
SCALE : free	UNIT : mm	THIS SPECIFICATION IS THE PROPERTY OF UNICTRON TECHNOLOGIES CORPORATION AND MAY NOT BE REPRODUCED OR USED IN WHOLE OR IN PART WITHOUT WRITTEN PERMISSION FROM UNICTRON.		
DRAWN By : Ray Hsieh	CHECKED BY: Hank Lee			
DESIGNED BY : KK Ting	APPROVED BY : Hank Lee			
TITLE : Level Sensor Transducer		DOCUMENT NO.	H2KLPY11000600	REV. A

## 7. Packing:

① Level sensor

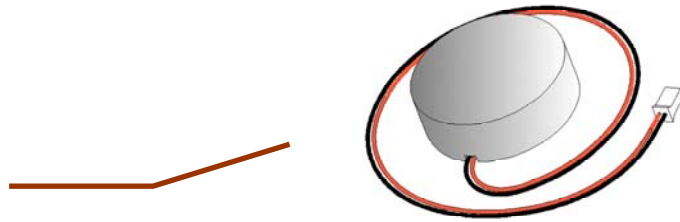

② Ten transducers in one bubble bag for well protection.

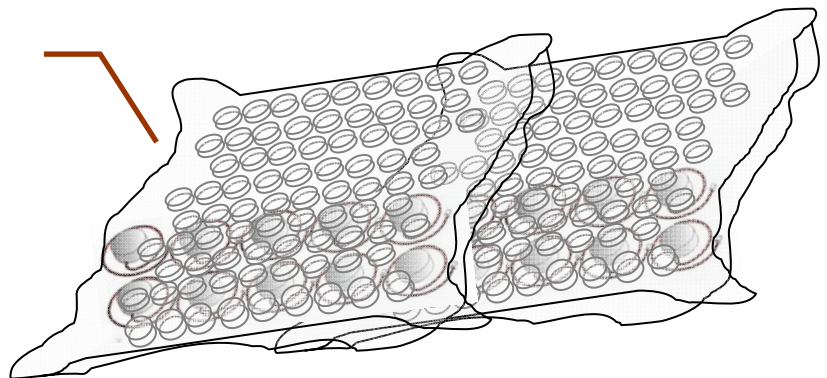

③ Two bags in one cell :  
25 cells per layer for fully  
protection. Two layers in  
the box, so there are 1000  
pcs transducer of every  
box.

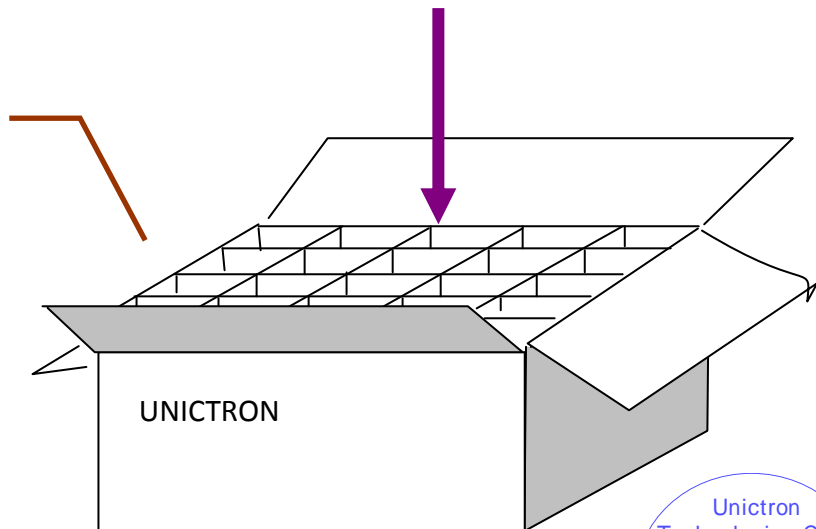

Unictron  
Technologies Corp.  
2018-11-14  
Document  
Control Center

TOLERANCES (UNLESS SPECIFIED OTHERWISE) X = ±            X.X = ±            X.XX =		詠業科技股份有限公司 Unictron Technologies Corporation Website: www.unictron.com							
ANGLES = ±            HOLE DIA = ±		THIS SPECIFICATION IS THE PROPERTY OF UNICTRON TECHNOLOGIES CORPORATION AND MAY NOT BE REPRODUCED OR USED IN WHOLE OR IN PART WITHOUT WRITTEN PERMISSION FROM UNICTRON.							
SCALE : free	UNIT : mm	<table border="1"> <tr> <td>DOCUMENT NO.</td> <td>H2KLPY11000600</td> <td>REV.</td> </tr> <tr> <td></td> <td></td> <td>A</td> </tr> </table>		DOCUMENT NO.	H2KLPY11000600	REV.			A
DOCUMENT NO.	H2KLPY11000600			REV.					
				A					
DRAWN By : Ray Hsieh	CHECKED BY: Hank Lee								
DESIGNED BY : KK Ting	APPROVED BY : Hank Lee								
TITLE : Level Sensor Transducer									