

### Dimensions: [mm]

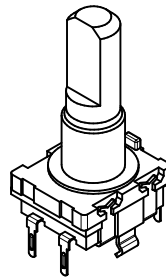

Scale - 1,2:1

### Recommended Hole Pattern: [mm]

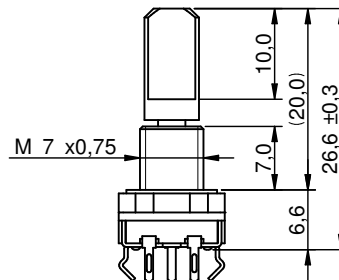
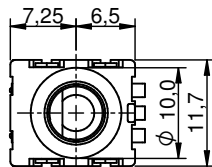
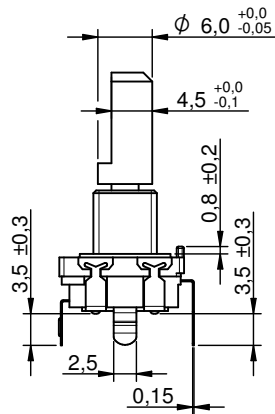
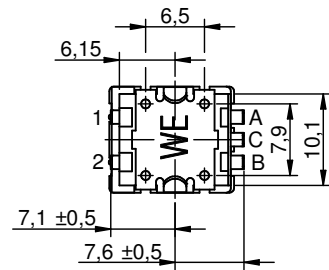
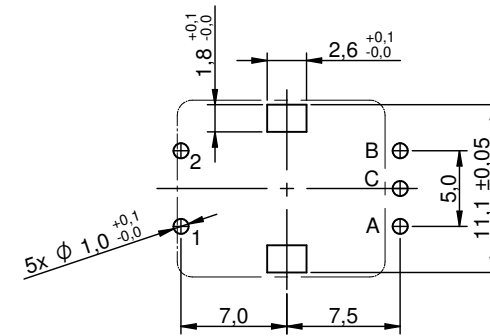

Scale - 2:1

### Schematic:

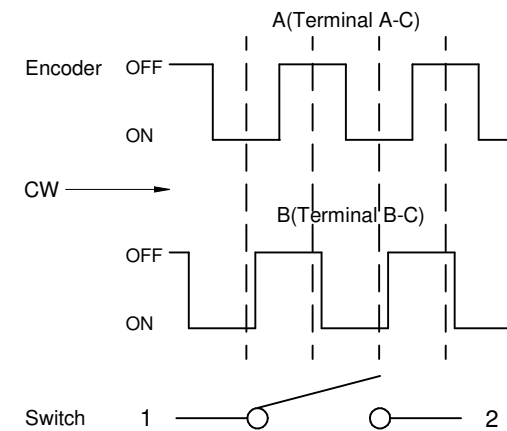

	CHECKED ICh	REVISION 002.001	DATE (YYYY-MM-DD) 2021-05-04	GENERAL TOLERANCE DIN ISO 2768-1m	PROJECTION METHOD 	
	DESCRIPTION <b>WS-ENTV Mechanical Incremental Encoder Switch</b>				ORDER CODE <b>482009514001</b>	
	WÜRTH Elektronik eiSos GmbH & Co. KG EMC & Inductive Solutions Max-Eyth-Str. 1 74638 Waldenburg Germany Tel. +49 (0) 79 42 945 - 0 www.we-online.com eiSos@we-online.com			BUSINESS UNIT eiCan	STATUS Valid	PAGE 1/8
	SIZE/TYPE 11.7 x 13.75 x 26.6 mm Shaft with bushing					

## Material Properties:

Actuator Material	Aluminium Alloy
Bushing Material	Zinc Alloy
Cover Material	Tin plate
Cover Plating	Tin
Contact Material	Copper Alloy
Contact Plating	Silver
Frame Material	PBT
Frame Flammability Rating	UL94 HB
Frame Color	Black
Terminal Material	Copper Alloy
Terminal Plating	Silver

## Electrical Properties:

Properties	Test conditions	Value	Unit	Tol.
Rated Current	$I_R$	10	mA	
Rated Voltage	$V_R$	5	V (DC)	
Bounce Encoder		3	ms	max.
Sliding Noise Encoder		3	ms	max.
Contact Resistance Initial	R for Switch	100	mΩ	max.
Contact Resistance After Life Test	R for Switch	300	mΩ	max.
Bounce	for Switch	10	ms	max.
Insulation Resistance	$R_{ISO}$ 250 V (DC)	100	MΩ	min.
Withstanding Voltage	1 min	300	V (AC)	

## Mechanical Properties:

Properties	Value	Unit	Tol.
Torque Encoder	20	mN*m	max.
Resolution	8	Pulse/360°	

## Mechanical Properties:

Properties	Value	Unit	Tol.
Detent	16	Positions	
Operation Force	600	g	+400/-300
Travel	0.5	mm	+0.4/-0.3
Electrical Life Encoder <sup>1)</sup>	15000	Cycles	
Electrical Life Switch <sup>2)</sup>	20000	Cycles	

<sup>1)</sup> Cycle – 1 CW + 1 CCW

<sup>2)</sup> Cycle – return to the original position

## General Information:



Operating Temperature	-40 up to +85 °C
Storage Conditions (in original packaging)	< 40 °C ; < 75 % RH
Moisture Sensitivity Level (MSL)	1
Bushing Type	Threaded

## Packaging Properties:

Properties	Value
Packaging	Tray
Packaging Unit	Qty. 100

## Certification:

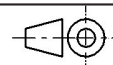
RoHS Approval	Compliant [2011/65/EU&2015/863]
REACH Approval	Conform or declared [(EC)1907/2006]

	CHECKED	REVISION	DATE (YYYY-MM-DD)	GENERAL TOLERANCE	PROJECTION METHOD	
	ICh	002.001	2021-05-04	DIN ISO 2768-1m		
	DESCRIPTION				ORDER CODE	
	<b>WS-ENTV Mechanical Incremental Encoder Switch</b>				<b>482009514001</b>	
	SIZE/TYPE	BUSINESS UNIT	STATUS	PAGE		
	11.7 x 13.75 x 26.6 mm Shaft with bushing	eiCan	Valid	2/8		

## Packaging Specification - Tray: [mm]

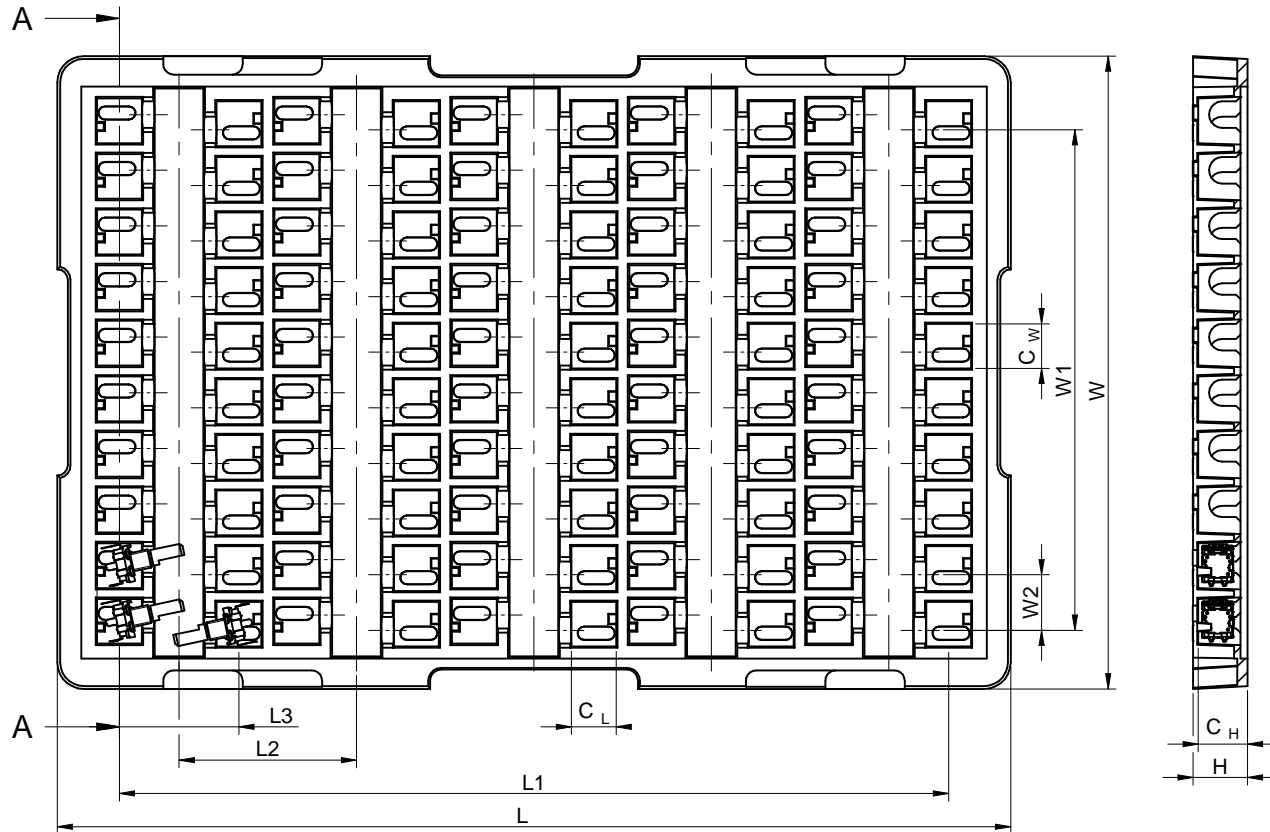

L (mm)	L1 (mm)	L2 (mm)	L3 (mm)	C <sub>L</sub> (mm)	W (mm)	W1 (mm)	W2 (mm)	C <sub>W</sub> (mm)	H (mm)	C <sub>H</sub> (mm)	Qty. (pcs.)	Material
typ.	typ.	typ.		typ.	typ.	typ.	typ.	typ.	typ.	typ.		
360,00	314,50	67,00	46,25	18,00	239,00	189,00	21,00	18,00	20,50	18,50	100	PET

## Packaging Specification - Inner Carton: [mm]

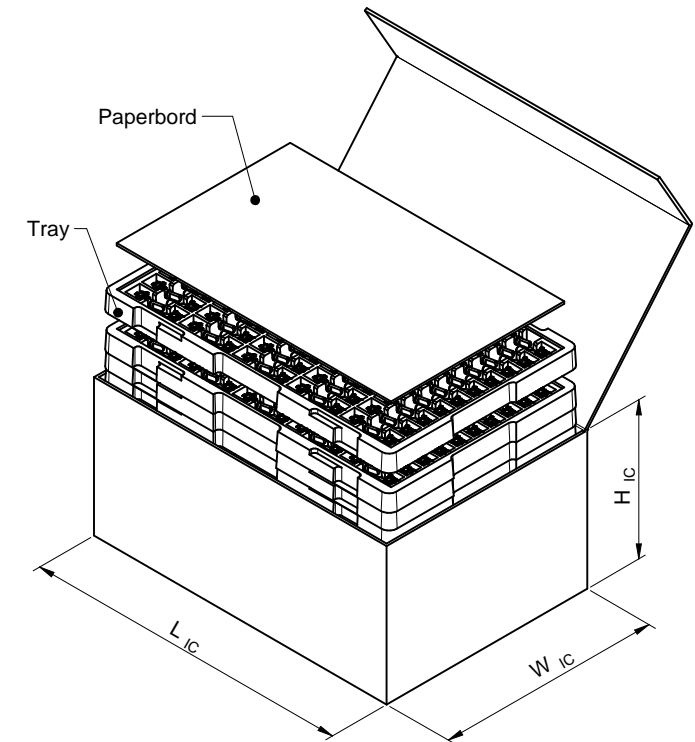

L <sub>IC</sub> (mm)	W <sub>IC</sub> (mm)	H <sub>IC</sub> (mm)	No. of Tray	Qty. (pcs.)	Material
typ.	typ.	typ.	pcs.	pcs.	
365	250	171	10	1000	Paper





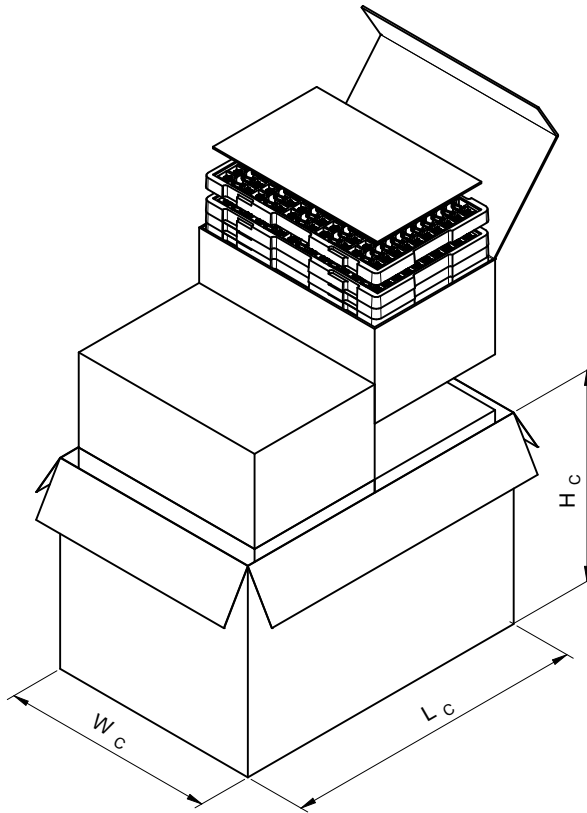

Würth Elektronik eiSos GmbH & Co. KG  
EMC & Inductive Solutions  
Max-Eyth-Str. 1  
74638 Waldenburg  
Germany  
Tel. +49 (0) 79 42 945 - 0  
www.we-online.com  
eiSos@we-online.com

CHECKED	REVISION	DATE (YYYY-MM-DD)	GENERAL TOLERANCE	PROJECTION METHOD
ICh	002.001	2021-05-04	DIN ISO 2768-1m	
DESCRIPTION				ORDER CODE
<b>WS-ENTV Mechanical Incremental Encoder Switch</b>				<b>482009514001</b>
SIZE/TYPE	BUSINESS UNIT	STATUS	PAGE	
11.7 x 13.75 x 26.6 mm Shaft with bushing	eiCan	Valid	3/8	

## Packaging Specification - Outer Carton: [mm]

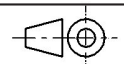

$L_c$ (mm)	$W_c$ (mm)	$H_c$ (mm)	No. of Inner Carton	Qty. (mm)	Material
typ.	typ.	typ.	pcs.	pcs.	
552	390	380	4	4000	Paper

 	CHECKED ICh	REVISION 002.001	DATE (YYYY-MM-DD) 2021-05-04	GENERAL TOLERANCE DIN ISO 2768-1m	PROJECTION METHOD 		
	DESCRIPTION <b>WS-ENTV Mechanical Incremental Encoder Switch</b>				ORDER CODE <b>482009514001</b>		
	Würth Elektronik eiSos GmbH & Co. KG EMC & Inductive Solutions Max-Eyth-Str. 1 74638 Waldenburg Germany Tel. +49 (0) 79 42 945 - 0 www.we-online.com eiSos@we-online.com			SIZE/TYPE 11.7 x 13.75 x 26.6 mm Shaft with bushing	BUSINESS UNIT eiCan	STATUS Valid	PAGE 4/8

## Classification Wave Soldering Profile:



## Classification Wave Soldering Profile:

Profile Feature		Pb-Free Assembly	Sn-Pb Assembly
Preheat Temperature Min	$T_{s \min}$	100 °C	100 °C
Preheat Temperature Typical	$T_{s \text{ typical}}$	120 °C	120 °C
Preheat Temperature Max	$T_{s \max}$	130 °C	130 °C
Preheat Time $t_s$ from $T_{s \min}$ to $T_{s \max}$	$t_s$	70 seconds	70 seconds
Ramp-up Rate	$\Delta T$	150 °C max.	150 °C max.
Peak Temperature	$T_p$	250 °C - 260 °C	235 °C - 260 °C
Time of actual peak temperature	$t_p$	max. 10 seconds max. 5 seconds each wave	max. 10 seconds max. 5 seconds each wave
Ramp-down Rate, Min		~ 2 K/ second	~ 2 K/ second
Ramp-down Rate, Typical		~ 3.5 K/ second	~ 3.5 K/ second
Ramp-down Rate, Max		~ 5 K/ second	~ 5 K/ second
Time 25 °C to 25 °C		4 minutes	4 minutes

refer to EN61760-1:2006

	CHECKED	REVISION	DATE (YYYY-MM-DD)	GENERAL TOLERANCE	PROJECTION METHOD
	ICh	002.001	2021-05-04	DIN ISO 2768-1m	
	DESCRIPTION				ORDER CODE
	<b>WS-ENTV Mechanical Incremental Encoder Switch</b>				<b>482009514001</b>
	SIZE/TYPE	BUSINESS UNIT	STATUS	PAGE	
	11.7 x 13.75 x 26.6 mm Shaft with bushing	eiCan	Valid	5/8	

## Cautions and Warnings:

### The following conditions apply to all goods within the product series of Encoder switch of Würth Elektronik eiSos GmbH & Co. KG:

#### General:

- This mechanical component is designed and manufactured for use in general electronic equipment.
- Würth Elektronik must be asked for written approval (following the PPAP procedure) before incorporating the components into any equipment in fields such as military, aerospace, aviation, nuclear control, submarine, transportation (automotive control, train control, ship control), transportation signal, disaster prevention, medical, public information network, etc. where higher safety and reliability are especially required and/or if there is the possibility of direct damage or human injury.
- Mechanical components that will be used in safety-critical or high-reliability applications, should be pre-evaluated by the customer.
- The component is designed and manufactured to be used within the datasheet specified values. If the usage and operation conditions specified in the datasheet are not met, the wire insulation may be damaged or dissolved.
- Do not drop or impact the components, the component may be damaged.
- Prevent any damage or scratches on the switch, especially on the actuator.
- Würth Elektronik products are qualified according to international standards, which are listed in each product reliability report. Würth Elektronik does not warrant any customer qualified product characteristics beyond Würth Elektronik's specifications, for its validity and sustainability over time.
- The responsibility for the applicability of the customer specific products and use in a particular customer design is always within the authority of the customer. All technical specifications for standard products also apply to customer specific products.

#### Product specific:

#### Soldering:

- The solder profile must comply with the technical product specifications. All other profiles will void the warranty.
- All other soldering methods are at the customers' own risk.
- Please keep our switch at delivery original position before and during the soldering process.
- Design the right angle part with consideration of the wave soldering process so that the parts will not touch the soldering wave during the soldering process or protect the switch part with cover fixture. Melt of the switch might cause malfunction.

#### Cleaning and Washing:

- If a series is washable, the general information section in the datasheet will contain the washability guidelines. Should there be no information regarding washability, the product has not been constructed to withstand a washing process. Washing agents used during the production to clean the customer application might damage or change the characteristics of the component, body, pins and/or termination. Washing agents may have a negative effect on the long-term functionality of the product.

If the parts are washable, hermetic:

- Cleaning agents used to clean the customers' applications, may damage or change the characteristics of the component, body, pins and termination.
- Please do not immerse any washable products into water or cleaning agents or put them in locations exposed to water completely.
- Do not clean washable series immediately after soldering. The cleaning agent may be absorbed into the switch through respiration while the switch cools.
- Please do not press actuator or change status /position during the cleaning and washing process.
- Using a brush during the cleaning process could deform function relevant areas. Therefore, we do not recommend using a brush during the PCB cleaning process.

#### Potting and Coating:

- If the product is potted in the customer application, the potting material may shrink or expand during and after hardening. Shrinking could lead to an incomplete seal, allowing contaminants into the body, pins or termination. Expansion could damage the components. We recommend a manual inspection after potting or coating to avoid these effects.

#### Storage Conditions:



- A storage of Würth Elektronik products for longer than 12 months is not recommended. Within other effects, the terminals may suffer degradation, resulting in bad solderability. Therefore, all products shall be used within the period of 12 months based on the day of shipment.
- Do not expose the components to direct sunlight.
- The storage conditions in the original packaging are defined according to DIN EN 61760-2.
- If there is a moisture sensitive component, the storage condition in the original packaging is defined according to IPC/JEDEC-J-STD-033. It is also recommended to return the component to the original moisture proof bag and reseal the moisture proof bag again.
- The storage conditions stated in the original packaging apply to the storage time and not to the transportation time of the components.

#### Packaging:

- The packaging specifications apply only to purchase orders comprising whole packaging units. If the ordered quantity exceeds or is lower than the specified packaging unit, packaging in accordance with the packaging specifications cannot be ensured.

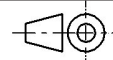

#### Handling:

- In the case a product requires particular handling precautions, in addition to the general recommendations mentioned here below, these will appear on the product datasheet.
- The mechanical incremental encoder may experience bounce or chattering and sliding noise based on the operation speed and operation force. These possible behaviours should be considered during the design stage on customer side. The chattering and noise measurements are based on 1 rotation /second. The operation speed when manually operated, may have different outcome. In order to have proper use between firmware and encoder, please test the part under real conditions.

		Würth Elektronik eiSos GmbH & Co. KG EMC & Inductive Solutions Max-Eyth-Str. 1 74638 Waldenburg Germany Tel. +49 (0) 79 42 945 - 0 www.we-online.com eiSos@we-online.com	CHECKED	REVISION	DATE (YYYY-MM-DD)	GENERAL TOLERANCE	PROJECTION METHOD	
			ICh	002.001	2021-05-04	DIN ISO 2768-1m		
			DESCRIPTION				ORDER CODE	
			<b>WS-ENTV Mechanical Incremental Encoder Switch</b>				<b>482009514001</b>	
			SIZE/TYPE	BUSINESS UNIT	STATUS	PAGE		
			11.7 x 13.75 x 26.6 mm Shaft with bushing	eiCan	Valid	6/8		

- The phase difference value can vary by different rotation speed and force. Our measurement is based on 1 rotation/second. The operation speed when manually operated, may have different outcome. In order to have proper use between firmware and encoder, please test the part under real conditions.
- Our encoder is not suitable for environments with high salt content or high moisture nor dew environments. Insulation deterioration or short circuits may occur.
- Do not repeatedly operate the switch with excessive force. It may damage or deform the switch, which may result in malfunction of the switch.
- Before setting the positions of the switch, one shall be sure that the PCB has cooled down.
- In order to reduce the shifting of the actuator, side force shall be avoided.
- If the actuator is long, the rotation wobble increases in proportion to its length. To secure the quality of a set, we recommend use of the types with a bushing.
- For products with switch function, we do not recommend to stack PCB's, in order to avoid malfunction of the switch.
- The temperature rise of the component must be taken into consideration. The operating temperature is comprised of ambient temperature and temperature rise of the component. The operating temperature of the component shall not exceed the maximum temperature specified.

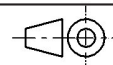
These cautions and warnings comply with the state of the scientific and technical knowledge and are believed to be accurate and reliable. However, no responsibility is assumed for inaccuracies or incompleteness.

	CHECKED	REVISION	DATE (YYYY-MM-DD)	GENERAL TOLERANCE	PROJECTION METHOD	
	ICh	002.001	2021-05-04	DIN ISO 2768-1m		
	DESCRIPTION				ORDER CODE	
	<b>WS-ENTV Mechanical Incremental Encoder Switch</b>				<b>482009514001</b>	
Würth Elektronik eiSos GmbH & Co. KG EMC & Inductive Solutions Max-Eyth-Str. 1 74638 Waldenburg Germany Tel. +49 (0) 79 42 945 - 0 www.we-online.com eiSos@we-online.com			SIZE/TYPE	BUSINESS UNIT	STATUS	PAGE
			11.7 x 13.75 x 26.6 mm Shaft with bushing	eiCan	Valid	7/8

## Important Notes

The following conditions apply to all goods within the product range of Würth Elektronik eiSos GmbH & Co. KG:

### 1. General Customer Responsibility

Some goods within the product range of Würth Elektronik eiSos GmbH & Co. KG contain statements regarding general suitability for certain application areas. These statements about suitability are based on our knowledge and experience of typical requirements concerning the areas, serve as general guidance and cannot be estimated as binding statements about the suitability for a customer application. The responsibility for the applicability and use in a particular customer design is always solely within the authority of the customer. Due to this fact it is up to the customer to evaluate, where appropriate to investigate and decide whether the device with the specific product characteristics described in the product specification is valid and suitable for the respective customer application or not.

### 2. Customer Responsibility related to Specific, in particular Safety-Relevant Applications

It has to be clearly pointed out that the possibility of a malfunction of electronic components or failure before the end of the usual lifetime cannot be completely eliminated in the current state of the art, even if the products are operated within the range of the specifications. In certain customer applications requiring a very high level of safety and especially in customer applications in which the malfunction or failure of an electronic component could endanger human life or health it must be ensured by most advanced technological aid of suitable design of the customer application that no injury or damage is caused to third parties in the event of malfunction or failure of an electronic component. Therefore, customer is cautioned to verify that data sheets are current before placing orders. The current data sheets can be downloaded at [www.we-online.com](http://www.we-online.com).

### 3. Best Care and Attention

Any product-specific notes, cautions and warnings must be strictly observed. Any disregard will result in the loss of warranty.

### 4. Customer Support for Product Specifications

Some products within the product range may contain substances which are subject to restrictions in certain jurisdictions in order to serve specific technical requirements. Necessary information is available on request. In this case the field sales engineer or the internal sales person in charge should be contacted who will be happy to support in this matter.

### 5. Product R&D

Due to constant product improvement product specifications may change from time to time. As a standard reporting procedure of the Product Change Notification (PCN) according to the JEDEC-Standard inform about minor and major changes. In case of further queries regarding the PCN, the field sales engineer or the internal sales person in charge should be contacted. The basic responsibility of the customer as per Section 1 and 2 remains unaffected.

## 6. Product Life Cycle



Due to technical progress and economical evaluation we also reserve the right to discontinue production and delivery of products. As a standard reporting procedure of the Product Termination Notification (PTN) according to the JEDEC-Standard we will inform at an early stage about inevitable product discontinuance. According to this we cannot guarantee that all products within our product range will always be available. Therefore it needs to be verified with the field sales engineer or the internal sales person in charge about the current product availability expectancy before or when the product for application design-in disposal is considered. The approach named above does not apply in the case of individual agreements deviating from the foregoing for customer-specific products.

## 7. Property Rights

All the rights for contractual products produced by Würth Elektronik eiSos GmbH & Co. KG on the basis of ideas, development contracts as well as models or templates that are subject to copyright, patent or commercial protection supplied to the customer will remain with Würth Elektronik eiSos GmbH & Co. KG. Würth Elektronik eiSos GmbH & Co. KG does not warrant or represent that any license, either expressed or implied, is granted under any patent right, copyright, mask work right, or other intellectual property right relating to any combination, application, or process in which Würth Elektronik eiSos GmbH & Co. KG components or services are used.

## 8. General Terms and Conditions

Unless otherwise agreed in individual contracts, all orders are subject to the current version of the "General Terms and Conditions of Würth Elektronik eiSos Group", last version available at [www.we-online.com](http://www.we-online.com).

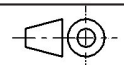
		Würth Elektronik eiSos GmbH & Co. KG EMC & Inductive Solutions Max-Eyth-Str. 1 74638 Waldenburg Germany Tel. +49 (0) 79 42 945 - 0 <a href="http://www.we-online.com">www.we-online.com</a> <a href="mailto:eiSos@we-online.com">eiSos@we-online.com</a>	CHECKED ICh	REVISION 002.001	DATE (YYYY-MM-DD) 2021-05-04	GENERAL TOLERANCE DIN ISO 2768-1m	PROJECTION METHOD 
			DESCRIPTION <b>WS-ENTV Mechanical Incremental Encoder Switch</b>		ORDER CODE <b>482009514001</b>		
			SIZE/TYPE 11.7 x 13.75 x 26.6 mm Shaft with bushing	BUSINESS UNIT eiCan	STATUS Valid	PAGE 8/8	