

IrDA Infrared communication Module

RPM871

RPM871 is an infrared communication module for IrDA Ver. 1.2 (Low Power). The infrared LED, PIN photo diode, LSI are all integrated into a single package. This module is designed with power down function and low current consumption at stand-by mode. The ultra small package makes it a perfect fit for mobile devices.

●Features

- 1) Applied to IrDA version 1.2. (Low Power)
- 2) Designed for low power consumption at waiting mode (Typ.73 μ A).
- 3) Suitable for sets driven by battery due to power down control function.
- 4) Power supply voltage range : 2.6V to 3.6V
- 5) Constant LED load resistance can change transmission distance. (Approx. 20 to 60cm)

●Applications

Cellular phones, PDAs, etc.

●Absolute maximum ratings (Ta = 25°C)

Parameter	Symbol	Limits	Unit
Power supply voltage	V _{CC}	-0.3 to +7.0	V
Power dissipation	P _d	150* ¹	mW
Operating temperature range	T _{opr}	-20 to +85	°C
Storage temperature range	T _{stg}	-30 to +100	°C
LED peak current	I _{FP}	200* ²	mA

*1 70mm×70mm, t=1.6mm, glass epoxy mounting. Derating : 2mW/°C for operation above Ta=25°C

*2 LED peak current<90 μ s. ON duty<20%

●Recommended operating conditions (Ta = 25°C)

Parameter	Symbol	Min.	Typ.	Max.	Unit
Power supply voltage	V _{CC}	2.6	2.8	3.6	V
	V _{LEDA}	2.6	2.8	5.5	V

Photo Link Module

●Block diagram and application circuit

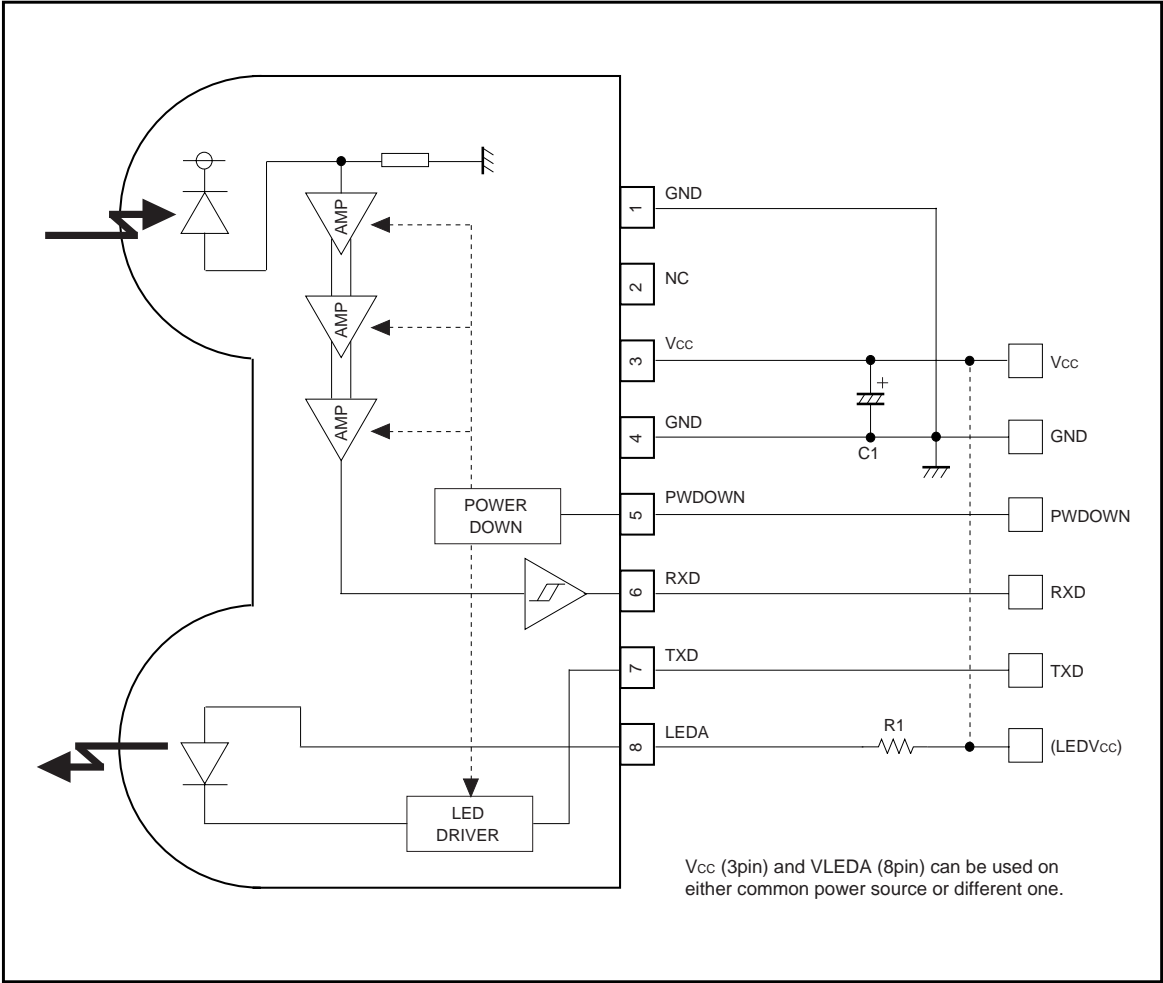

Photo Link Module

●Terminal description

Pin No	Terminal	Circuit	Function
1, 4	GND		GND
2	NC		This Terminal must be left open.
3	V _{cc}		V _{cc} For preventing from infection, connect a capacitor between V _{cc} (3pin) and GND (4pin).
5	PWDOWN		Power-down Control Terminal H : POWERDOWN L : OPERATION CMOS Logic Level Input When input is H, it will stop the receiving circuit, Pin-PD current and transmitting LED operation.
6	RXD		Receiving Data Output Terminal CMOS Logic Level Output When PWDOWN (5pin)=H, the RXD output will be pulled up to V _{cc} at approximately 300kΩ.
7	TXD		Transmitting Data Input Terminal H : LED (PWDOWN=L) CMOS Logic Level Input Holding TXD="H" status, LED will be turn off approximately 45μs.
8	LEDA		LED ANODE Terminal Other power source can be used difference between LEDV _{cc} and V _{cc} . LED current depends on LED load resistance value.

Photo Link Module

●Electrical characteristics (Unless otherwise noted, $V_{CC}=2.8V$, $V_{LEDV_{CC}}=2.8V$, $T_a = 25^{\circ}C$)

Parameter	Symbol	Min.	Typ.	Max.	Unit	Conditions
Consumption current1	I_{CC1}	–	73	99	μA	Waiting mode At no input light
Consumption current2	I_{CC2}	–	0.01	0.2	μA	PWDOWN PIN High At no input light
Transmission rate		2.4	–	115.2	kbps	
PWDOWN INPUT High voltage	VPDH	$V_{CC}-0.55$	–	–	V	
PWDOWN INPUT Low voltage	VPDL	–	–	0.55	V	
PWDOWN INPUT High current	IPDH	–1.0	0	1.0	μA	PWDOWN= V_{CC} [V]
PWDOWN INPUT Low current	IPDL	–1.0	0	1.0	μA	PWDOWN=0 [V]

<Transmitter>

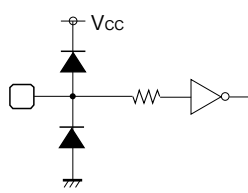
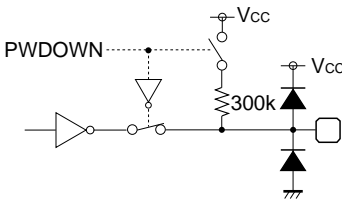
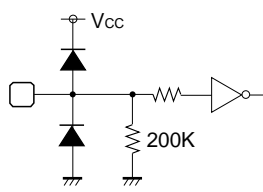
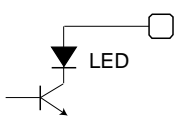
TXD INPUT High voltage	VTXH	$V_{CC}-0.55$	–	–	V	
TXD INPUT Low voltage	VTXL	–	–	0.55	V	
TXD INPUT High current	ITXH	7	14	28	μA	TXD= V_{CC} [V]
TXD INPUT Low current	ITXL	–1.0	0	1.0	μA	TXD=0 [V]
LED ANODE current	ILED _A	–	144	–	mA	$R_1=7.5 [\Omega]$

<Receiver>

RXD OUTPUT High voltage	VRXH	$V_{CC}-0.5$	–	–	V	IRXH= $-50\mu A$
RXD OUTPUT Low voltage	VRXL	–	–	0.4	V	IRXL= $200\mu A$
RXD OUTPUT rise time	t _{RR}	–	70	–	ns	$C_L=15pF$
RXD OUTPUT fall time	t _{FR}	–	30	–	ns	$C_L=15pF$
RXD OUTPUT pulse width	tw _{RXD}	1.5	2.3	3.6	μs	$C_L=15pF$, 2.4 to 115.2kbps
Receiver latency time	t _{RT}	–	100	300	μs	

●Optical characteristics (Unless otherwise noted, $V_{CC}=2.8V$, $V_{LEDV_{CC}}=2.8V$, $T_a = 25^{\circ}C$)

Parameter	Symbol	Min.	Typ.	Max.	Unit	Conditions
Peak wave length	λ_P	850	870	900	nm	
Intensity1	IE1	14.4	36	93.6	mW/Sr	$-15^{\circ} \leq \theta_L \leq 15^{\circ}$ $R_1=7.5 [\Omega]$
Half-angle	$\theta_{L/2}$	–	± 18	± 30	deg	
Rise time / Fall time	T _r /T _f	–	–	100	ns	10% to 90%
Optical over shoot		–	–	25	%	
Edge jitter	T _j	–40	–	40	ns	
Minimum irradiance	E _{emin}	–	–	6.8	$\mu W/cm^2$	$-15deg \leq \theta_L \leq +15deg$
Maximum irradiance	E _{emax}	500	–	–	mW/cm ²	$-15deg \leq \theta_L \leq +15deg$
INPUT Half-Angular	$\theta_{D/2}$	± 15	–	–	deg	
Maximum emitting time	TLED _{max}	10	45	96	μs	TXD= V_{CC}

1. This product is not designed for protection against radioactive rays.
2. This product dose not include laser transmitter.
3. This product includes one PIN photo diode.
4. This product dose not include optical load.

Photo Link Module

●Timing chart

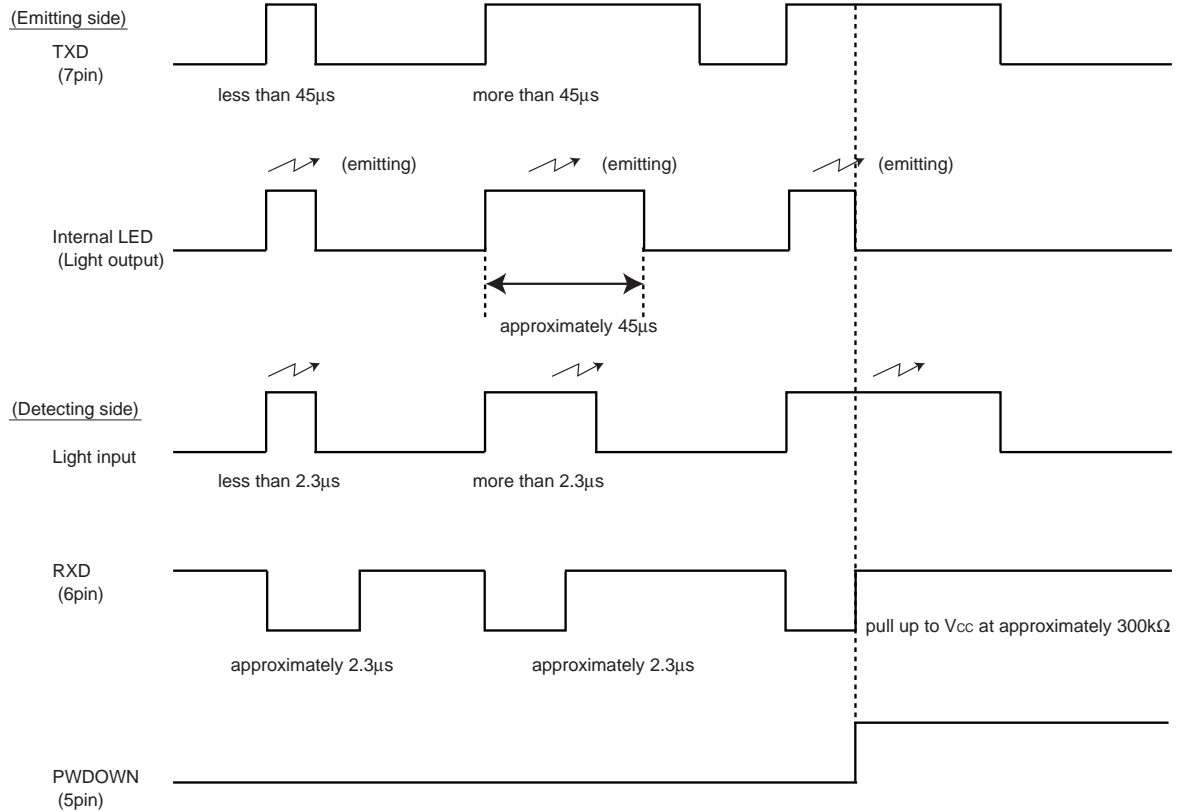

●Attached components

Recommended values

Part symbol	Recommended value	Notice
C1	1μF, tantalum or ceramic Ex.) TCFGA1A105M8R (ROHM)	Bigger capacitance is recommended with much noise from power supply
R1	7.5Ω±5%, 1/4W (VLEDV _{CC} =2.8V)	More than 60cm distance, more than 4[μW/cm ²] at detecting side. (vs ver1.0)
		More than 46cm distance, more than 6.8[μW/cm ²] at detecting side. (vs RPM871)

In case of using R1 with different condition from the above, formula is as follows :

LED resistance value : R1[Ω], LED average consumption current : ILED[mA], Supply voltage : VLEDV_{CC}[V],

Link distance : d[cm] (Including LED's distribution within ±15deg)

$$R1 = T \times (VLEDV_{CC} - 1.45) / d^2 - 3.5 \text{ [}\Omega\text{]}$$

$$ILED = \text{Duty} \times (VLEDV_{CC} - 1.36) / (R1 + 2.5) \text{ [A]}$$

Duty : LED duty at emitting

T : 17300 (vs. RPM871), 29400 (vs. ver1.0)

* Please set up to be ILED / Duty < 200[mA] (Duty < 20%)

Photo Link Module

●Notes

1) LEDV_{CC} (8pin) and V_{CC} (3pin)

- Other power source can be used difference between LEDV_{CC} and V_{CC}.

2) Caution in designing board lay-out

To get maximum potential from RPM871, please keep in mind following instruction.

- The line of RXD (6pin) should be connected at backside via through hole close to RPM871 pin lead. Better not to be close to photo diode side (1pin).

⇒This is to minimize feedback supplied to photo diode from RXD.

- As for C1 between 3-4 pin should be placed close to RPM871.
- Better to be placed more than 1.0cm in radius from photo diode (pin1 side) and also away from the parts which generates noise, such as DC / DC converter.

3) Others

- Please be sure to set up the TXD (7pin) input to be "L" (under 0.55V) except transmitting data (for < 90μsec. on duty < 20%).
- Power down current might increase if exposed by strong light (ex. direct sunlight) at power down mode.
- Please use by the signal format which is specified by IrDA Ver1.2 (2.4k to 115.2kbps). There might be on error if used by different signal format.
- Dust or dirt on lens portion may affect the characteristics, so pay sufficient attention.

4) LED current derating and ambient temperature

The relation between LED peak current and maximum ambient temperature is shown below.

We recommend you to use within the range as indicated in below.

a) When glass-epoxy board (70×70×1.6mm) mounted.

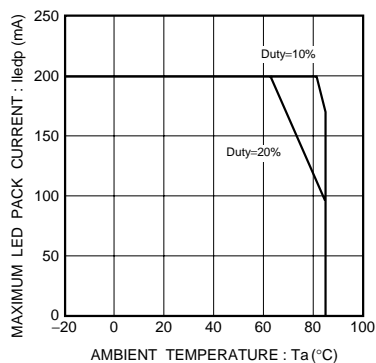

b) RPM871

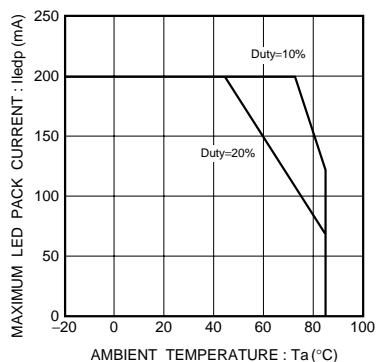
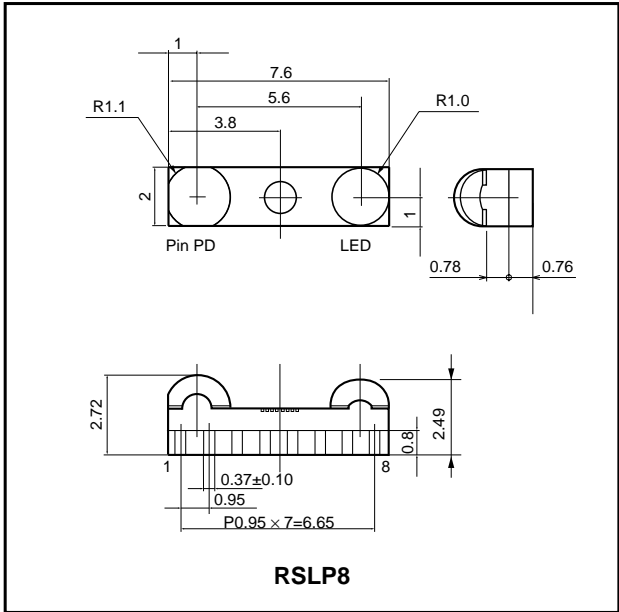

Photo Link Module

●External dimensions (Unit : mm)



Notes

- No technical content pages of this document may be reproduced in any form or transmitted by any means without prior permission of ROHM CO.,LTD.
- The contents described herein are subject to change without notice. The specifications for the product described in this document are for reference only. Upon actual use, therefore, please request that specifications to be separately delivered.
- Application circuit diagrams and circuit constants contained herein are shown as examples of standard use and operation. Please pay careful attention to the peripheral conditions when designing circuits and deciding upon circuit constants in the set.
- Any data, including, but not limited to application circuit diagrams information, described herein are intended only as illustrations of such devices and not as the specifications for such devices. ROHM CO.,LTD. disclaims any warranty that any use of such devices shall be free from infringement of any third party's intellectual property rights or other proprietary rights, and further, assumes no liability of whatsoever nature in the event of any such infringement, or arising from or connected with or related to the use of such devices.
- Upon the sale of any such devices, other than for buyer's right to use such devices itself, resell or otherwise dispose of the same, no express or implied right or license to practice or commercially exploit any intellectual property rights or other proprietary rights owned or controlled by
- ROHM CO., LTD. is granted to any such buyer.
- Products listed in this document are no antiradiation design.

The products listed in this document are designed to be used with ordinary electronic equipment or devices (such as audio visual equipment, office-automation equipment, communications devices, electrical appliances and electronic toys).

Should you intend to use these products with equipment or devices which require an extremely high level of reliability and the malfunction of which would directly endanger human life (such as medical instruments, transportation equipment, aerospace machinery, nuclear-reactor controllers, fuel controllers and other safety devices), please be sure to consult with our sales representative in advance.

About Export Control Order in Japan

Products described herein are the objects of controlled goods in Annex 1 (Item 16) of Export Trade Control Order in Japan.

In case of export from Japan, please confirm if it applies to "objective" criteria or an "informed" (by MITI clause) on the basis of "catch all controls for Non-Proliferation of Weapons of Mass Destruction.