

SF2434E-1

**1223 MHz
SAW Filter**

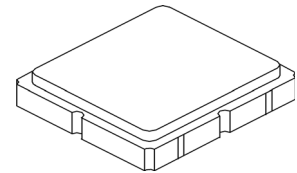

SM3030-6

- **Designed for Front-end GPS Applications**
- **Low Insertion Loss**
- **3.0 x 3.0 x 1.3 mm Surface-Mount Case**
- **No matching circuit required**
- **Complies with Directive 2002/95/EC (RoHs)**
- **Moisture Sensitivity Level: 1**
- **AEC-Q200 Qualified**
- **Maximum Ratings at °C Unless Stated**

Rating	Value	Units
Maximum Input Power Level	+10	dBm
DC Voltage	3	Volts
Specification Temperature Range	-40 to +105	°C
Operable Temperature Range	-45 to +125	°C
Storage Temperature Range in Tape and Reel	-40 to +85	°C

Electrical Characteristics

Characteristic	Sym	Notes	Min	Typ	Max	Units
Center Frequency	Fc			1223		MHz
3 dB Bandwidth				75		MHz
Maximum Insertion Loss (1196 to 1250 MHz)	IL			3.0	3.5	dB
Return Loss (1196 to 1250 MHz)				7.5		dB
Amplitude Ripple (1196 to 1250 MHz)				1.0	2.0	
Group Delay Ripple (1196 to 1250 MHz) (1196 to 1250 MHz) 2 MHz Sliding Window (ref - 1226.577 to 1228.623 MHz) (ref - 1196.91 to 1217.37 MHz) (ref - 1242.426 to 1249.886 MHz)				11	15	ns
				3.0	5.0	
				2.0	7.0	
				4.5	7.0	
Attenuation Referenced to 0 dB: 100 to 703 MHz 703 - 748 MHz 880 - 915 MHz 1710 - 1785 MHz 1850 - 1910 MHz 1920 - 1980 MHz 1980 - 4000 MHz 4000 - 6000 MHz				44		dB
			35	44		
			35	40		
			35	39		
			35	41		
			35	40		
				13		
Temperature Coefficient of Frequency				-36		ppmk
Lid Symbolization (Y=year, WW=week, S=shift), dot = Pin 1 Indicator	9G, YWWS					

Electrical Connections

Pin #	Description	Pin #	Description
1	Ground	4	Ground
2	Input	5	Output
3	Ground	6	Ground

Measurement Circuit

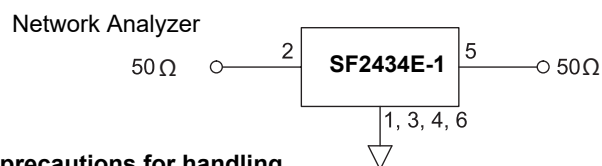

 **CAUTION: Electrostatic Sensitive Device. Observe precautions for handling.**
NOTES:

1. The design, manufacturing process, and specifications of this device are subject to change.
2. US or International patents may apply.
3. RoHS compliant from the first date of manufacture.

Frequency Characteristics

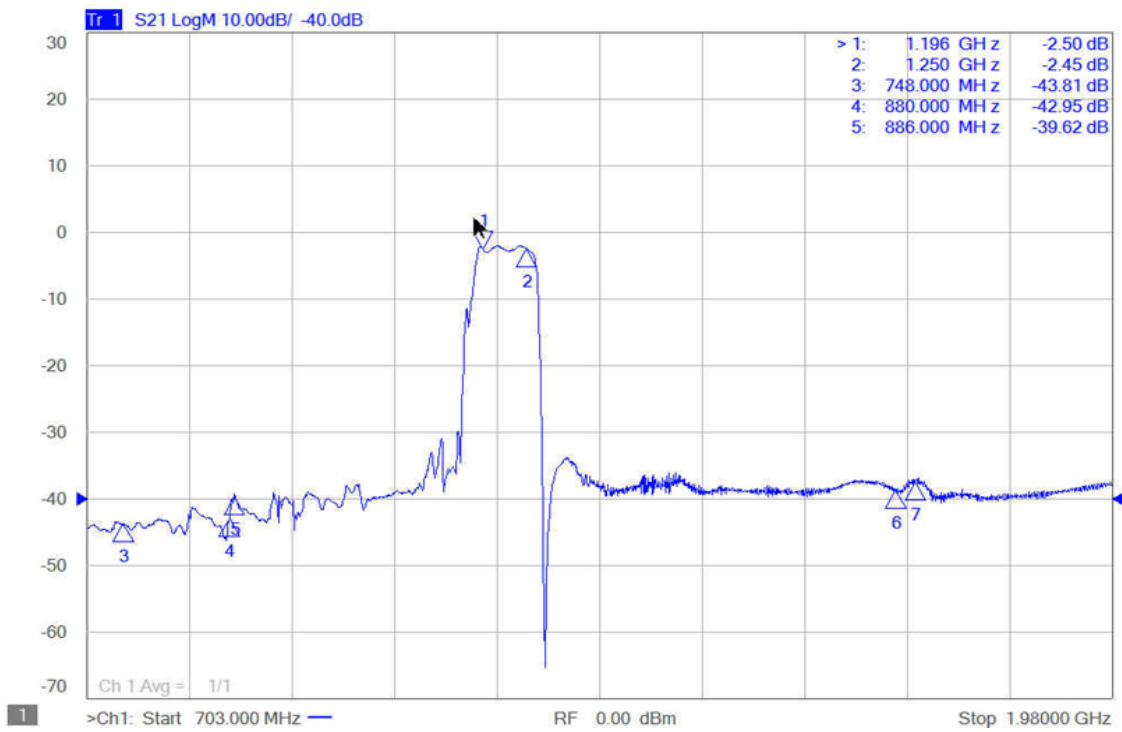
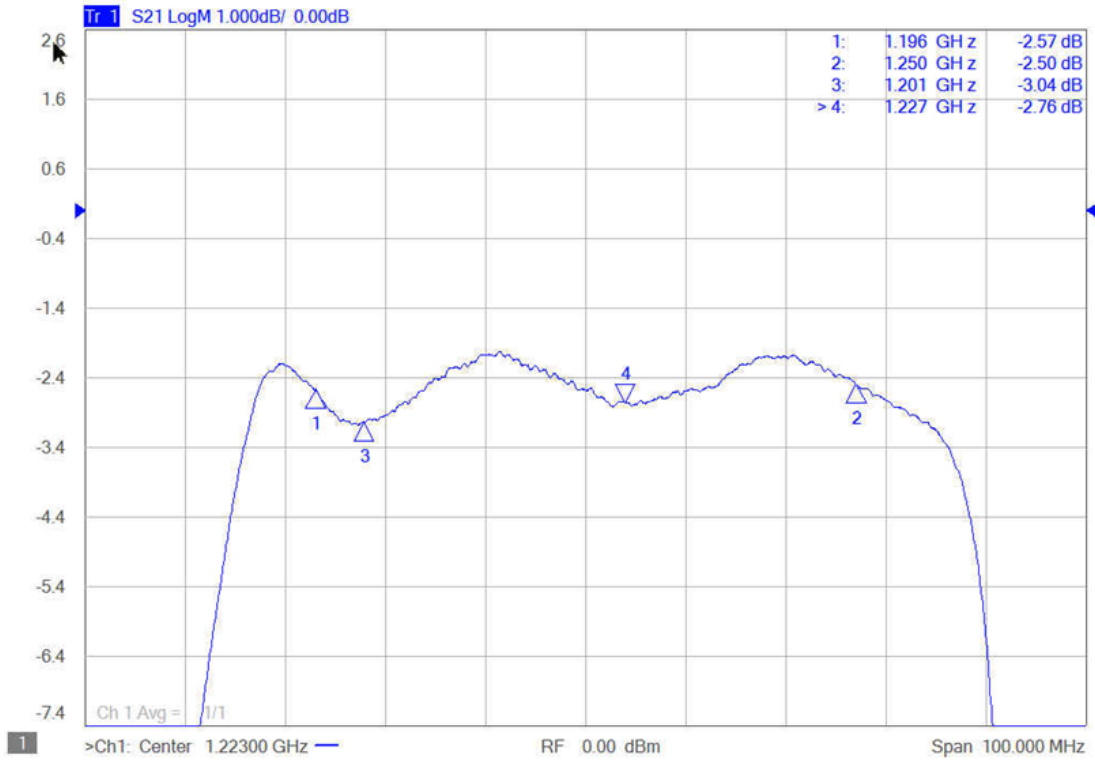

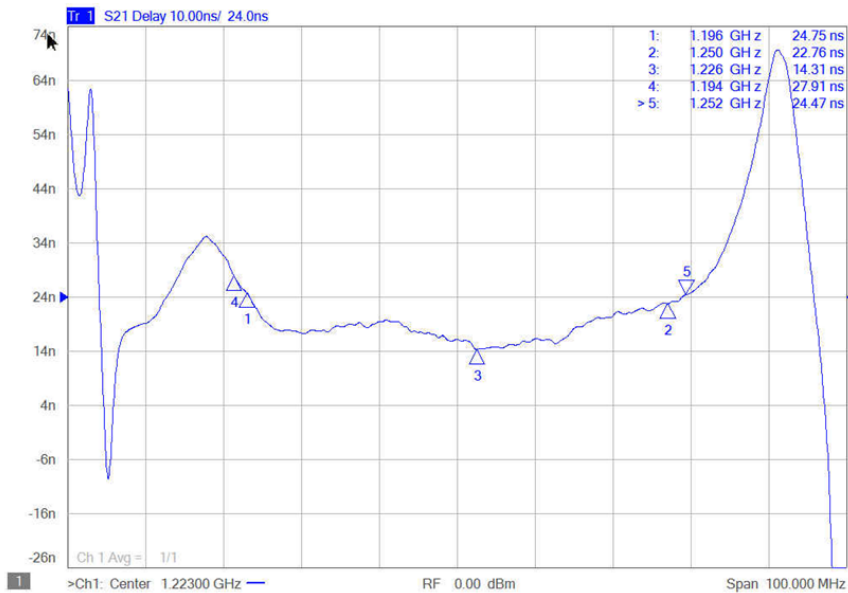

S21 10dB/div

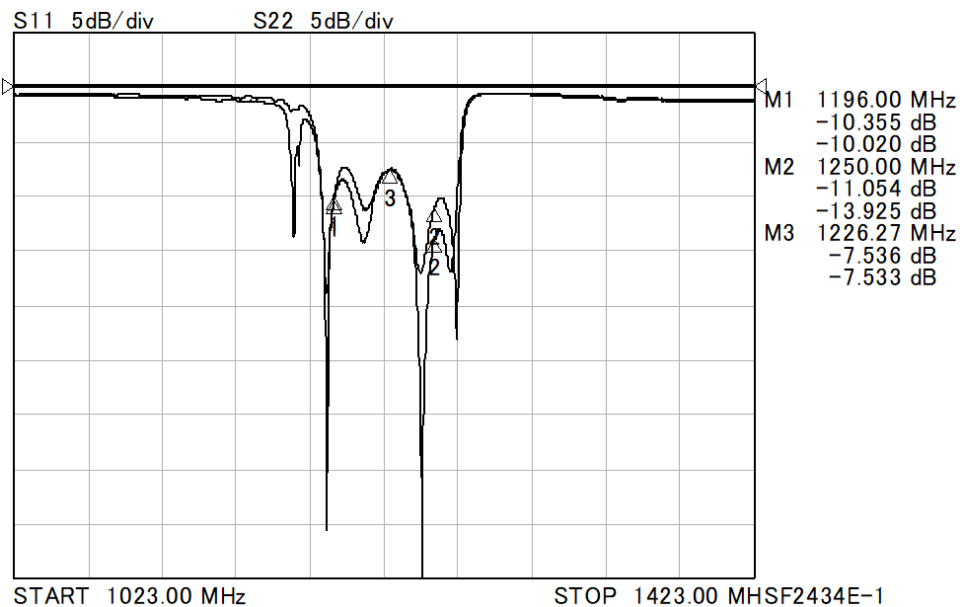
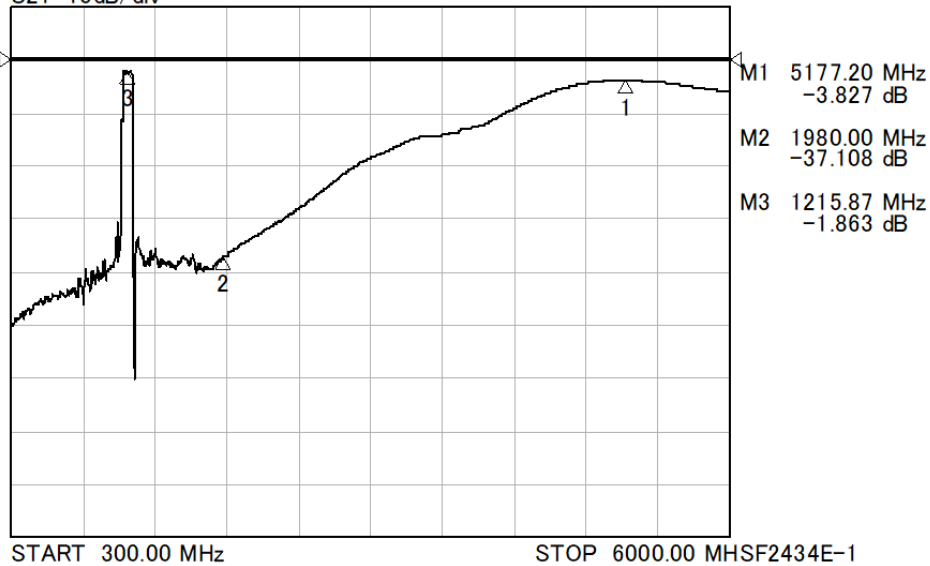

SM3030-6 Case

6-Terminal Ceramic Surface-Mount Case

3.0 X 3.0 mm Nominal Footprint

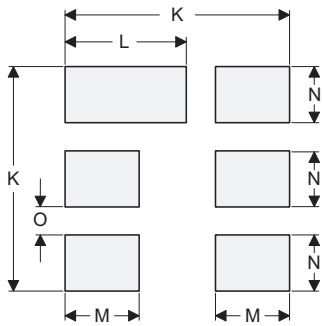
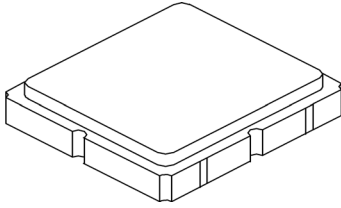

PCB Land Pattern
Top View

Case and PCB Footprint Dimensions

Dimension	mm			Inches		
	Min	Nom	Max	Min	Nom	Max
A	2.87	3.00	3.13	0.113	0.118	0.123
B	2.87	3.00	3.13	0.113	0.118	0.123
C	1.12	1.25	1.38	0.044	0.049	0.054
D	0.77	0.90	1.03	0.030	0.035	0.040
E	2.67	2.80	2.93	0.105	0.110	0.115
F	1.47	1.60	1.73	0.058	0.063	0.068
G	0.72	0.85	0.98	0.028	0.033	0.038
H	1.37	1.50	1.63	0.054	0.059	0.064
I	0.47	0.60	0.73	0.019	0.024	0.029
J	1.17	1.30	1.43	0.046	0.051	0.056
K		3.20			0.126	
L		1.70			0.067	
M		1.05			0.041	
N		0.81			0.032	
O		0.38			0.015	
P	0.15	0.30	0.45	0.005	0.011	0.017
Q	0.07	0.20	0.36	0.002	0.007	0.014
R	0.62	0.7	0.78	0.024	0.027	0.030

Case Materials	
Solder Pad Plating	0.3 to 1.0 μm Gold over 1.27 to 8.89 μm Nickel
Lid Plating	2.0 to 3.0 μm Nickel
Body	Al_2O_3 Ceramic

TOP VIEW

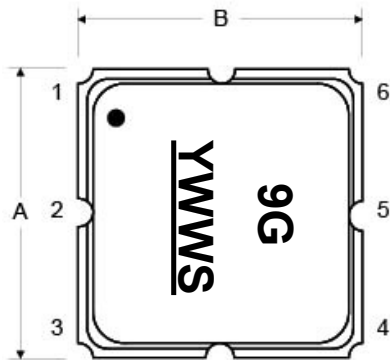

BOTTOM VIEW

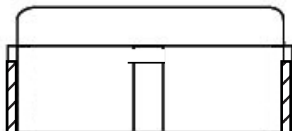
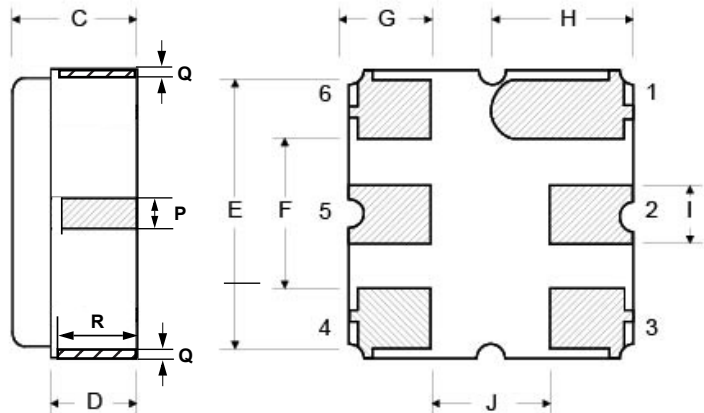

Tape and Reel Specifications

Tape and Reel Standard per ANSI/EIA-481

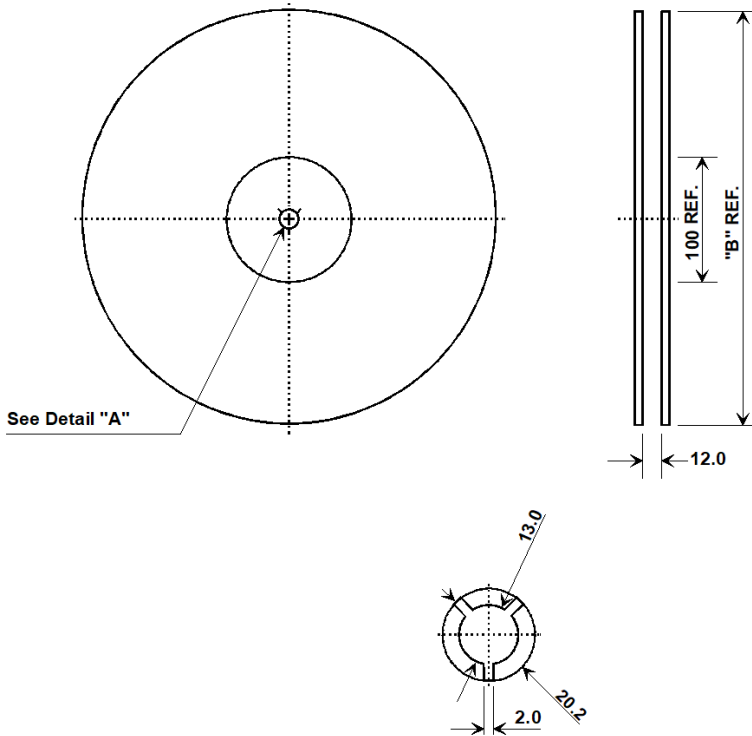

"B"		Quantity Per Reel
Inches	millimeters	
7	178	500
13	330	3000

COMPONENT ORIENTATION

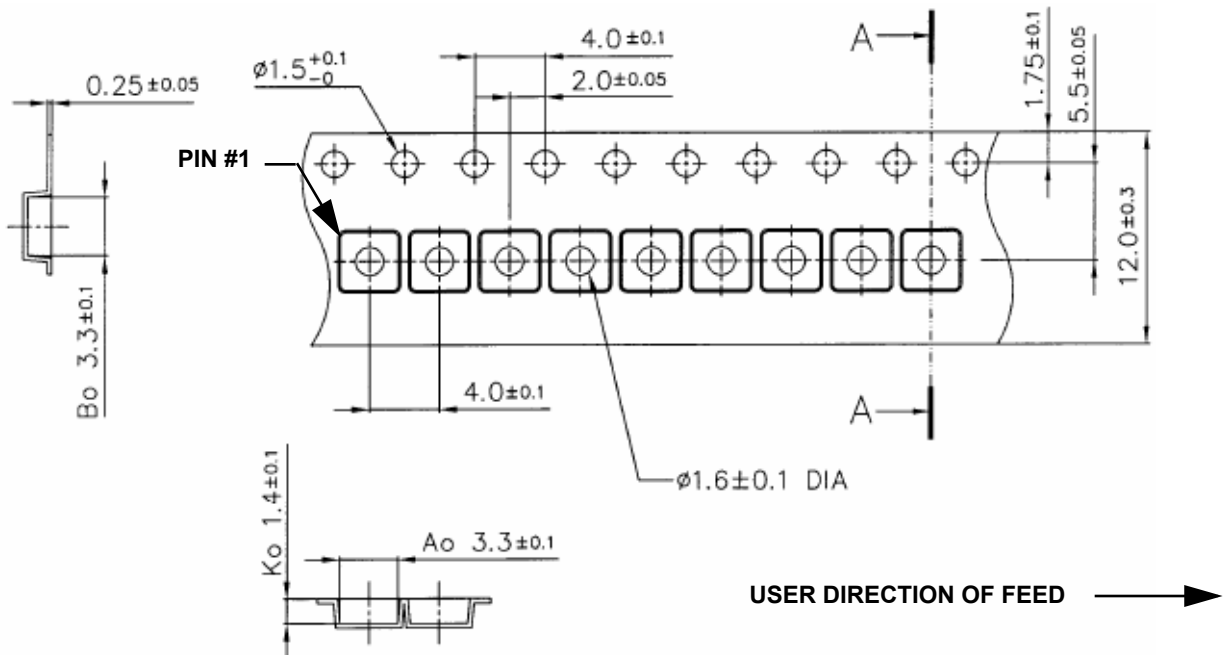

Recommended Reflow Profile

1. Preheating shall be fixed at 150~180°C for 60~90 seconds.
2. Ascending time to preheating temperature 150°C shall be 30 seconds min.
3. Heating shall be fixed at 220°C for 50~80 seconds and at 260°C +0/-5°C peak (10 seconds).
4. Time: 5 times maximum.

