

## Digital Attenuator, 5-Bit, 15.5 dB 400 - 2500 MHz

Rev. V2

### Features

- 5 Bits, 0.5 dB Steps
- Excellent Accuracy
- Single Positive Control (+3 V to +5 V)
- Lead-Free QSOP-16 (SSOP-16) Package
- 100% Matte Tin Plating over Copper
- Halogen-Free “Green” Mold Compound
- 260°C Reflow Compatible
- RoHS\* Compliant Version of MAATSS0001

### Description

M/A-COM's MAATSS0017 is a 0.5 dB step GaAs MMIC digital attenuator with 15.5 dB attenuation range in a lead-free QSOP-16 (SSOP-16) package. It requires external DC blocking capacitors on the RF ports, positive supply voltage and five individual bit control voltages.

The MAATSS0017 is particularly suited where high attenuation accuracy, low insertion loss and low intermodulation products are required. Typical applications include base stations, wireless data, and wireless local loop gain level control circuits.

The MAATSS0017 is fabricated using M/A-COM's GaAs 1.0 micron process. The process features full chip passivation for increased performance and reliability.

### Ordering Information <sup>1</sup>

Part Number	Package
MAATSS0017	Bulk Packaging
MAATSS0017TR	1000 piece reel
MAATSS0017SMB	Sample Test Board

1. Reference Application Note M513 for reel size information.

### Functional Schematic

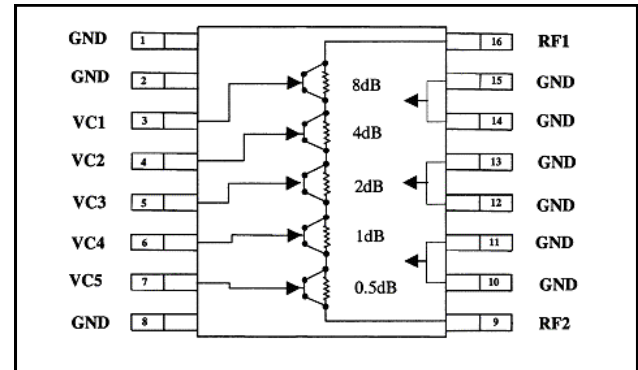

### Pin Configuration

Pin No.	Function	Pin No.	Function
1	GND	9	RF2
2	GND	10	GND
3	VC1	11	GND
4	VC2	12	GND
5	VC3	13	GND
6	VC4	14	GND
7	VC5	15	GND
8	GND	16	RF1

### Recommended Configuration

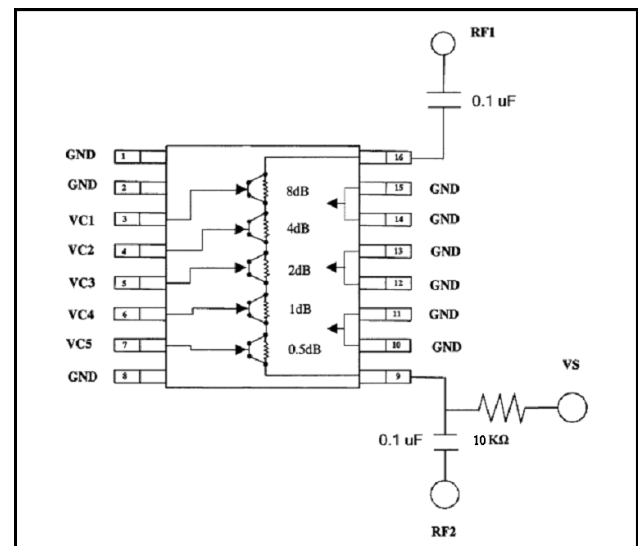

\* Restrictions on Hazardous Substances, European Union Directive 2002/95/EC.

## Digital Attenuator, 5-Bit, 15.5 dB 400 - 2500 MHz

Rev. V2

Electrical Specifications:  $T_A = 25\text{ }^\circ\text{C}$ ,  $Z_0 = 50\ \Omega$ ,  $V_s = +5\ \text{V}$ ,  $V_c = 0\ \text{V} / 5\ \text{V}$

Parameter	Conditions	Frequency	Units	Min.	Typ.	Max.
Insertion Loss (reference state)	—	0.5 - 1.8 GHz	dB	—	1.9	2.2
		1.8 - 2.2 GHz	dB	—	2.2	2.5
		2.2 - 2.5 GHz	dB	—	2.5	2.8
VSWR	Any State	0.5 - 2.5 GHz	Ratio	—	1.6:1	—
Accuracy	Any State	0.5 - 0.8 GHz 0.8 - 1.8 GHz 1.8 - 2.2 GHz 2.2 - 2.5 GHz		$\pm (0.3 + 4\% \text{ atten setting})$ $\pm (0.3 + 3\% \text{ atten setting})$ $\pm (0.3 + 6\% \text{ atten setting})$ $\pm (0.3 + 8\% \text{ atten setting})$		
Attenuation Range	—	0.5 - 2.5 GHz	dB	14.3	15.5	—
1 dB Compression Input Power	+3 V	0.5 - 2.5 GHz	dBm	—	25	—
	+5 V	0.5 - 2.5 GHz	dBm	—	30	—
IP3	Two tones, $P_{in} \leq +5\ \text{dBm/tone}$ +3 V +5 V	0.5 - 2.5 GHz	dBm	—	36	—
		0.5 - 2.5 GHz	dBm	—	46	—
Trise, Tfall	10/90% or 90/10% RF	—	$\mu\text{S}$	—	2	—
Ton, Toff	50% CNTL to 90/10% RF	—	$\mu\text{S}$	—	2	—
Transients	In Band	—	mV	—	62	—
Control Current	+3 V	—	$\mu\text{A}$	—	—	40
	+5 V	—	$\mu\text{A}$	—	—	40

### Truth Table <sup>2</sup>

Control Inputs					
VC5	VC4	VC3	VC2	VC1	Attenuation (dB)
1	1	1	1	1	Reference
0	1	1	1	1	0.5 dB
1	0	1	1	1	1 dB
1	1	0	1	1	2 dB
1	1	1	0	1	4 dB
1	1	1	1	0	8 dB

2. 0 =  $0.0\ \text{V} \pm 0.2\ \text{V}$ ,  
1 =  $V_s = 5.0\ \text{V} \pm 0.2\ \text{V}$

## Typical Performance Curves

**Insertion Loss**

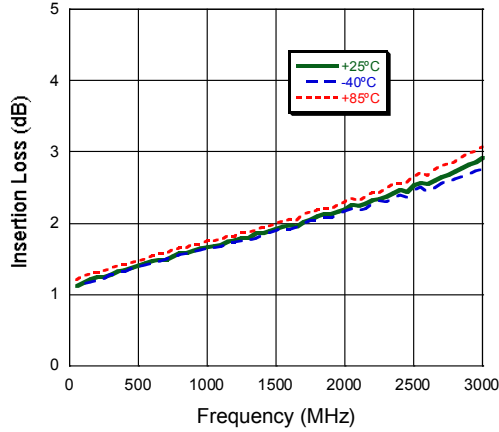

**Attenuation at Major Bits**

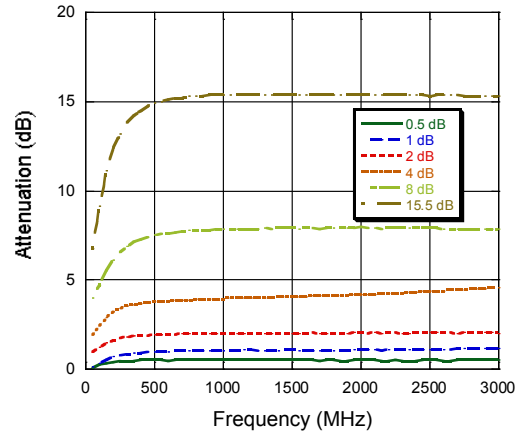

**Input Return Loss**

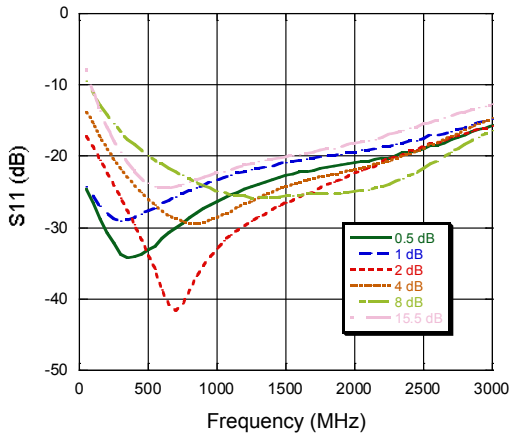

**Output Return Loss**

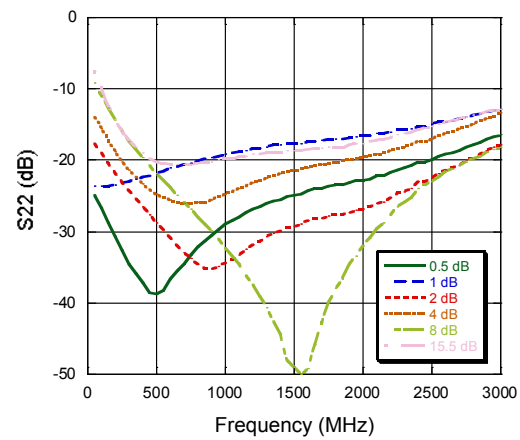

**Attenuation Accuracy**

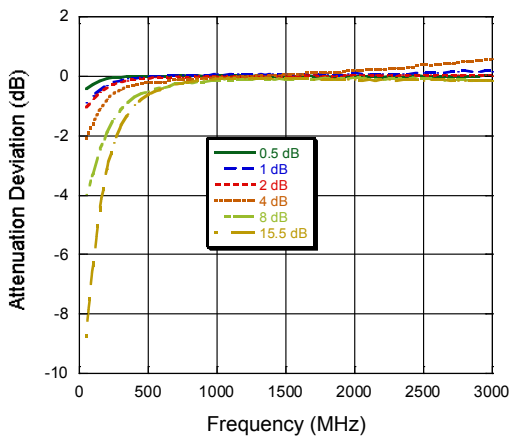

**Attenuation Accuracy vs. Setting**

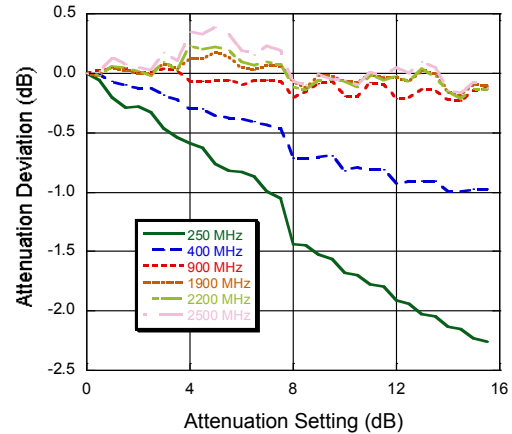

## Typical Performance Curves

Step size (low frequency)

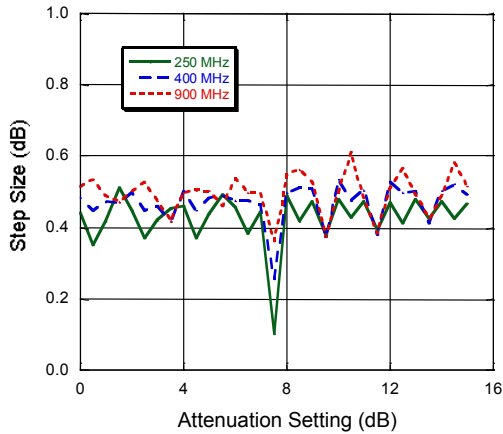

Step size (high frequency)

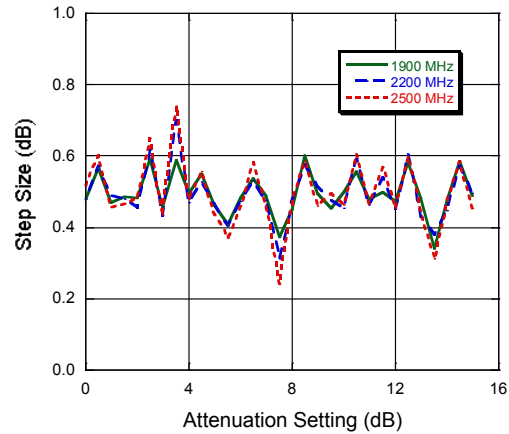

IIP3, +5 V, at 0 dB Attenuation Setting

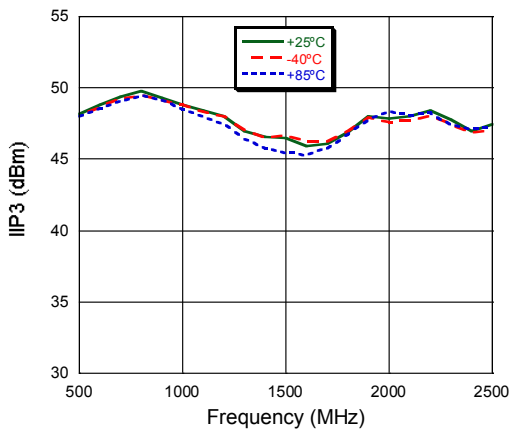

IIP3, +3 V, at 0 dB Attenuation Setting

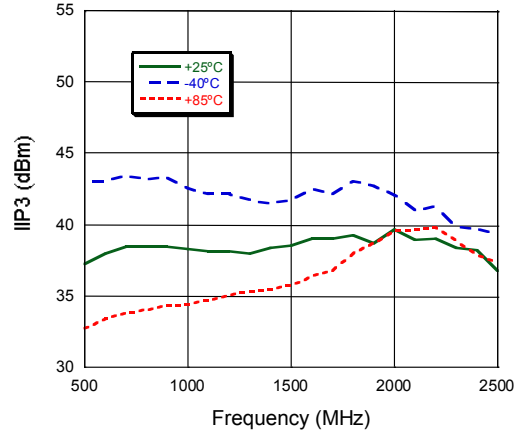

IIP3, +5 V, vs. Attenuation Setting

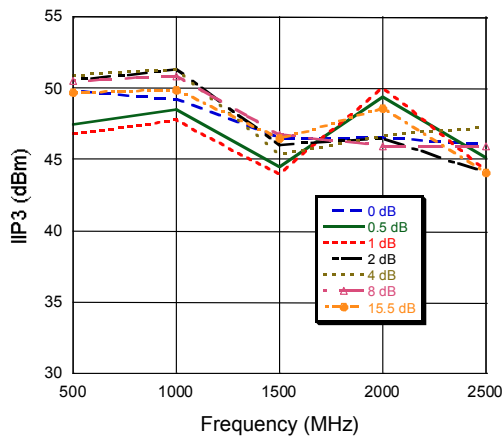

Sample Board Loss

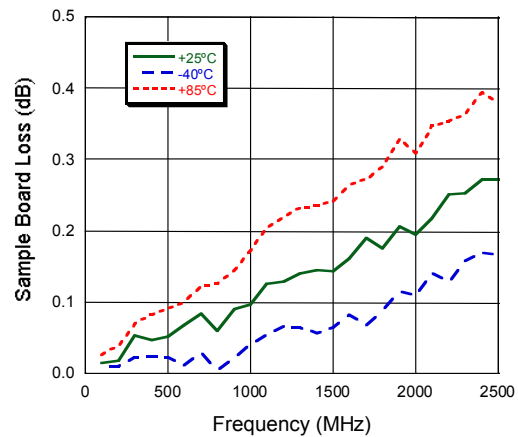

**Digital Attenuator, 5-Bit, 15.5 dB**  
**400 - 2500 MHz**

Rev. V2

## Lead-Free QSOP-16 (SSOP-16)<sup>†</sup>

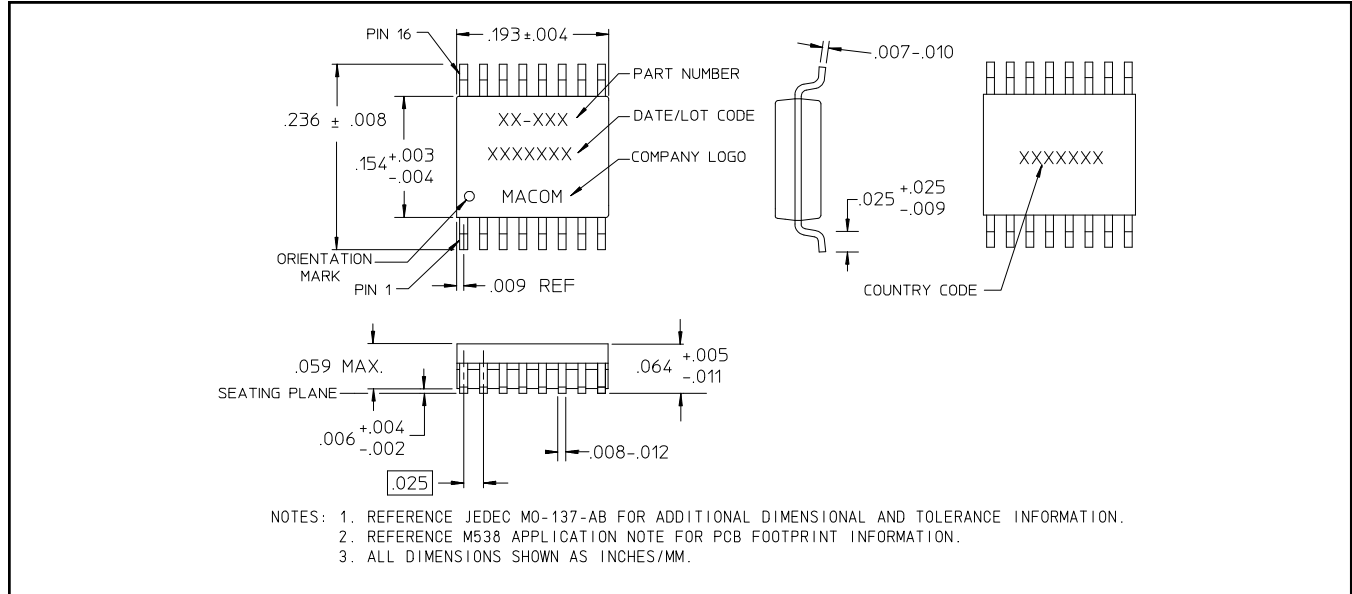

<sup>†</sup> Reference Application Note M538 for lead-free solder reflow recommendations.

## Absolute Maximum Ratings<sup>3,4</sup>

Parameter	Absolute Maximum
Input Power	+34 dBm
Voltage	+7 V
Operating Temperature	-40°C to +85°C
Storage Temperature	-65°C to +125°C

- Exceeding any one or combination of these limits may cause permanent damage to this device.
- M/A-COM does not recommend sustained operation near these survivability limits.

## Operating Instructions

The MAATSS0017 is designed to operate with 5 V logic levels. The difference between +3 V and +5 V operation is minimal for small signal performance. IIP3, however, is a strong function of voltage. +3 V is the minimum voltage at which the product will reliably operate.

The MAATSS0017 requires a parallel interface that allows the user to enter a 5 bit digital word. Each state increments the attenuation by 0.5 dB giving a total range of 15.5 dB.

The MAATSS0017 is not internally DC blocked. This means that the device requires DC blocking capacitors on the RF1 and RF2 ports. M/A-COM recommends 0.1 uF to allow for the entire frequency range to be utilized. Higher frequency applications can use smaller value capacitors as DC blocks.

For application information concerning this and other M/A-COM products, please visit our website at [www.macom.com](http://www.macom.com), where information including soldering profiles, reliability procedures, and S-parameter data can be found.

M/A-COM Technology Solutions Inc. All rights reserved.

Information in this document is provided in connection with M/A-COM Technology Solutions Inc ("MACOM") products. These materials are provided by MACOM as a service to its customers and may be used for informational purposes only. Except as provided in MACOM's Terms and Conditions of Sale for such products or in any separate agreement related to this document, MACOM assumes no liability whatsoever. MACOM assumes no responsibility for errors or omissions in these materials. MACOM may make changes to specifications and product descriptions at any time, without notice. MACOM makes no commitment to update the information and shall have no responsibility whatsoever for conflicts or incompatibilities arising from future changes to its specifications and product descriptions. No license, express or implied, by estoppel or otherwise, to any intellectual property rights is granted by this document.

THESE MATERIALS ARE PROVIDED "AS IS" WITHOUT WARRANTY OF ANY KIND, EITHER EXPRESS OR IMPLIED, RELATING TO SALE AND/OR USE OF MACOM PRODUCTS INCLUDING LIABILITY OR WARRANTIES RELATING TO FITNESS FOR A PARTICULAR PURPOSE, CONSEQUENTIAL OR INCIDENTAL DAMAGES, MERCHANTABILITY, OR INFRINGEMENT OF ANY PATENT, COPYRIGHT OR OTHER INTELLECTUAL PROPERTY RIGHT. MACOM FURTHER DOES NOT WARRANT THE ACCURACY OR COMPLETENESS OF THE INFORMATION, TEXT, GRAPHICS OR OTHER ITEMS CONTAINED WITHIN THESE MATERIALS. MACOM SHALL NOT BE LIABLE FOR ANY SPECIAL, INDIRECT, INCIDENTAL, OR CONSEQUENTIAL DAMAGES, INCLUDING WITHOUT LIMITATION, LOST REVENUES OR LOST PROFITS, WHICH MAY RESULT FROM THE USE OF THESE MATERIALS.

MACOM products are not intended for use in medical, lifesaving or life sustaining applications. MACOM customers using or selling MACOM products for use in such applications do so at their own risk and agree to fully indemnify MACOM for any damages resulting from such improper use or sale.

6

---

M/A-COM Technology Solutions Inc. (MACOM) and its affiliates reserve the right to make changes to the product(s) or information contained herein without notice.  
Visit [www.macom.com](http://www.macom.com) for additional data sheets and product information.