



SERPAC

Electronic Enclosures

🌿 RoHS Compliant

- Customization Available
- Most Models Meet or Exceed NEMA 4, IP66, IP67



Table of Contents

A

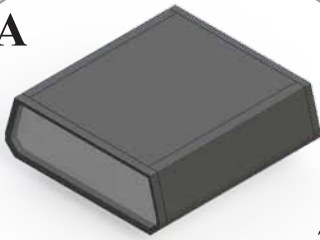

page 2

I



page 10

WM



page 18

C



page 4

M



page 11

SE



page 20

CA

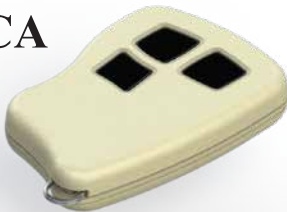

page 5

P



page 12

Customization



page 22

CH



page 6

RB

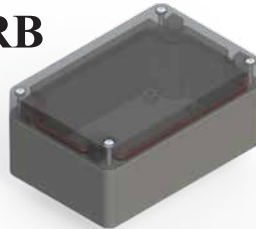

page 13

G



page 7

S

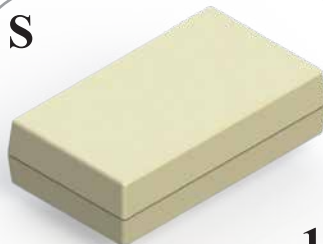

page 14

H



page 8

SL



page 17

Standard Design Features

- PCB Mounting Bosses
- 4 Piece Design
- ABS Plastic - Standard
- Lap Joint Design
- Interchangeable End Panels
- Bosses for Self Tapping Screws

Material

- ABS - UL94HB

End Panel/Accessories:

- Infrared, Clear, DB9/DB25, 9V Battery, Standard, Custom
- Rubber Feet
- Pad/Full Color Printing
- Custom Materials Available

Color

● Enclosures

- Black
- Grey
- Almond

● End Panels

- Clear
- IR
- Black
- Transparent Red

● Custom Colors and Combinations available

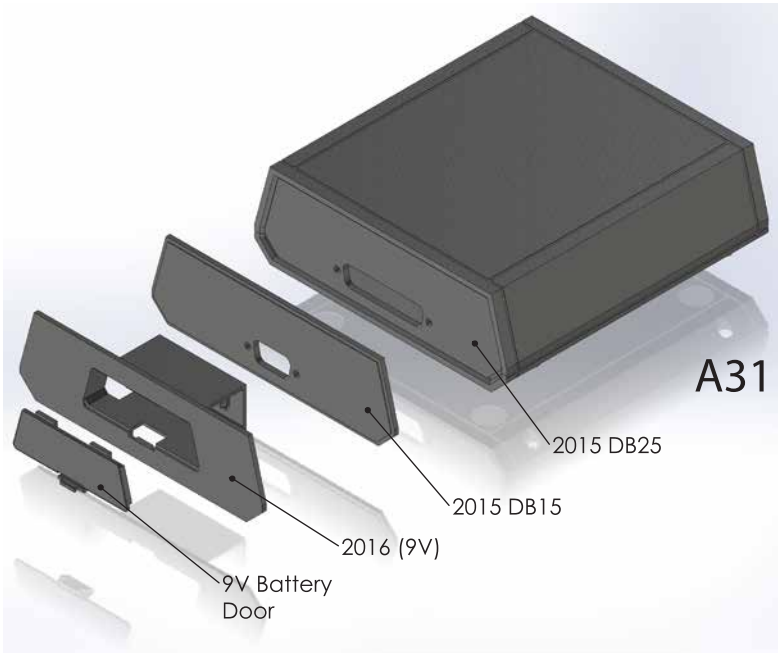
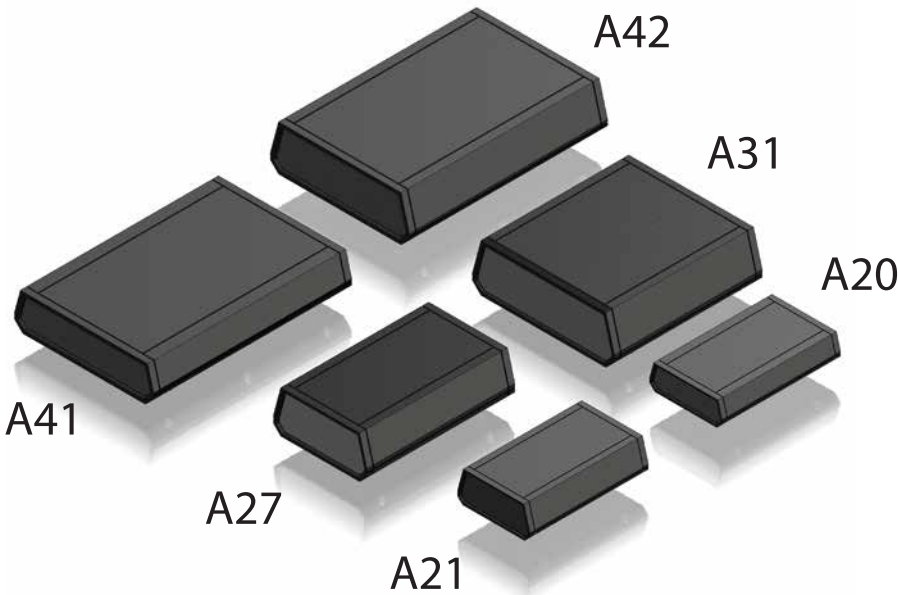

Model	L (in.)	W (in.)	H (in.)
A20	4.25	2.60	0.88
A21	4.25	2.60	1.13
A27	5.31	3.35	1.50
A31	5.31	5.10	1.71
A41	7.12	5.00	1.31
A42	7.12	5.00	1.62

9V Battery Powered

Model	L (in.)	W (in.)	H (in.)
A20,9V	4.25	2.60	0.88
A21,9V	4.25	2.60	1.13
A27,9V	5.31	3.35	1.50
A31,9V	5.31	5.10	1.71
A41,9V	7.12	5.00	1.31
A42,9V	7.12	5.00	1.62

A series

End Panel Information

Model	Infrared	Clear	DB 9	DB 25	9V
A20	2003 IR	2003 CL	2003 DB9	2003 DB25	N/A
A21	2005 IR	2005 CL	2005 DB9	20053 DB25	2006
A27	2010 IR	2010 CL	2010	20103 DB25	2011
A31	2015 IR	2015 CL	2015	20153 DB25	2016
A41	2020 IR	2020 CL	2020	20203 DB25	2021
A42	2024 IR	2024 CL	2024	20243 DB25	2025

*9V and DB End Panels in Black only

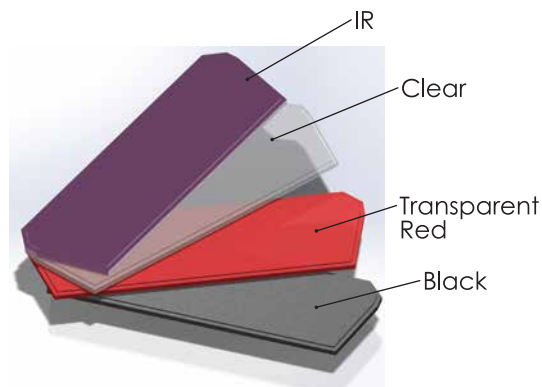

A Series End Panel Thickness

- All End Panels are .060 Thick Except for A-42 which is .125

Clear and Transparent Red Panel Characteristics

- Dielectric Strength: 85 KV/mil
Continuous operating temperature: -50°C (-58°F) to 74°C (165°F)

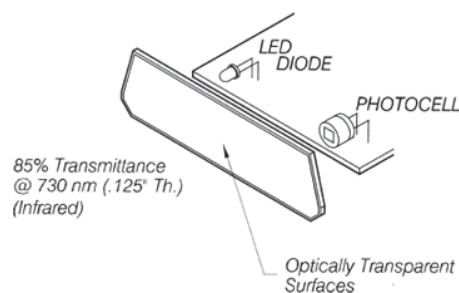
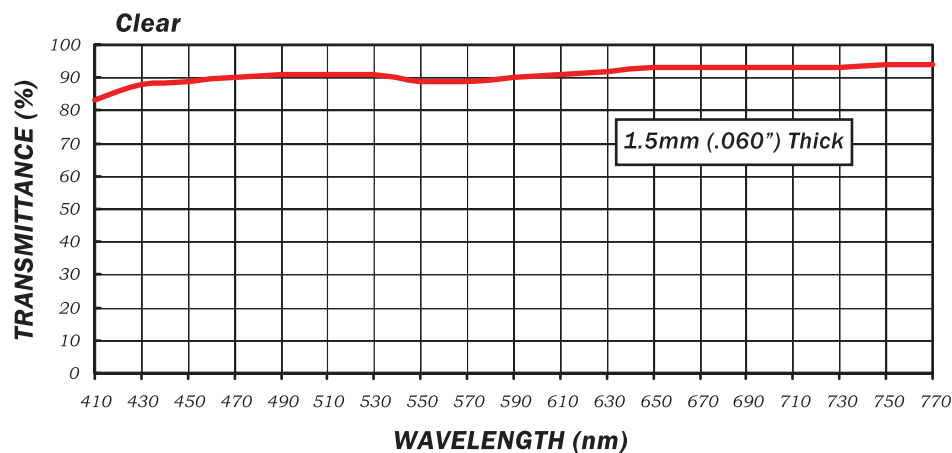

Infrared Panel Characteristics

- Dielectric Strength: 380 V/mil
Continuous operating temperature: -129°C (-200°F) to 276°C (310°F)

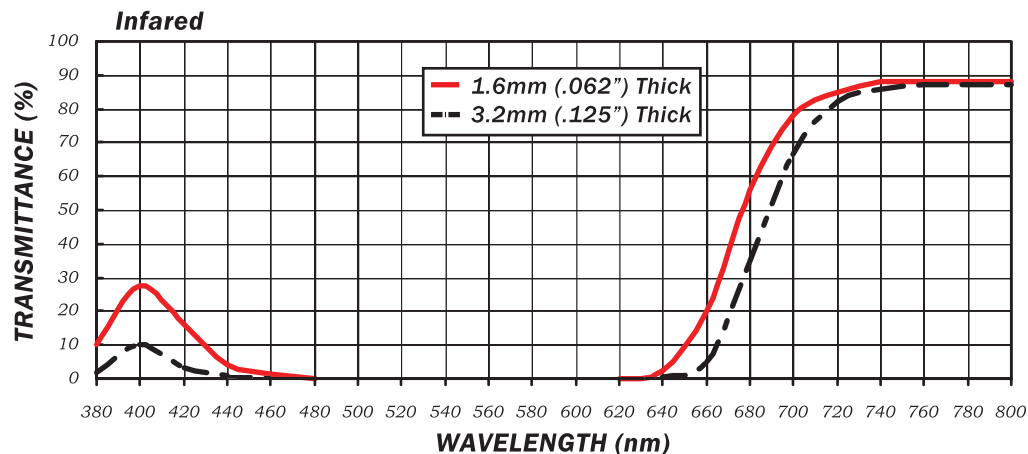

Standard Design Features

- PCB Trap Mount
- 2 Piece Design
- ABS Plastic - Standard
- Lap Joint Design
- Boss for Self Tapping Screw
- Single Screw Assembly (included)

Material

- ABS - UL94HB

Options\Accessories:

- Machining
- Pad/Full Color Printing
- EMI Shielding: Spray or Molded
- Pocket Clip
- Flexible Key Holder

Color

- Black
- Grey
- Almond
- Translucent Blue*
- Translucent Gray*
- Translucent Green*
- Translucent Red*

*Not Stocked for C12 & C28

- Custom Colors and Combinations available

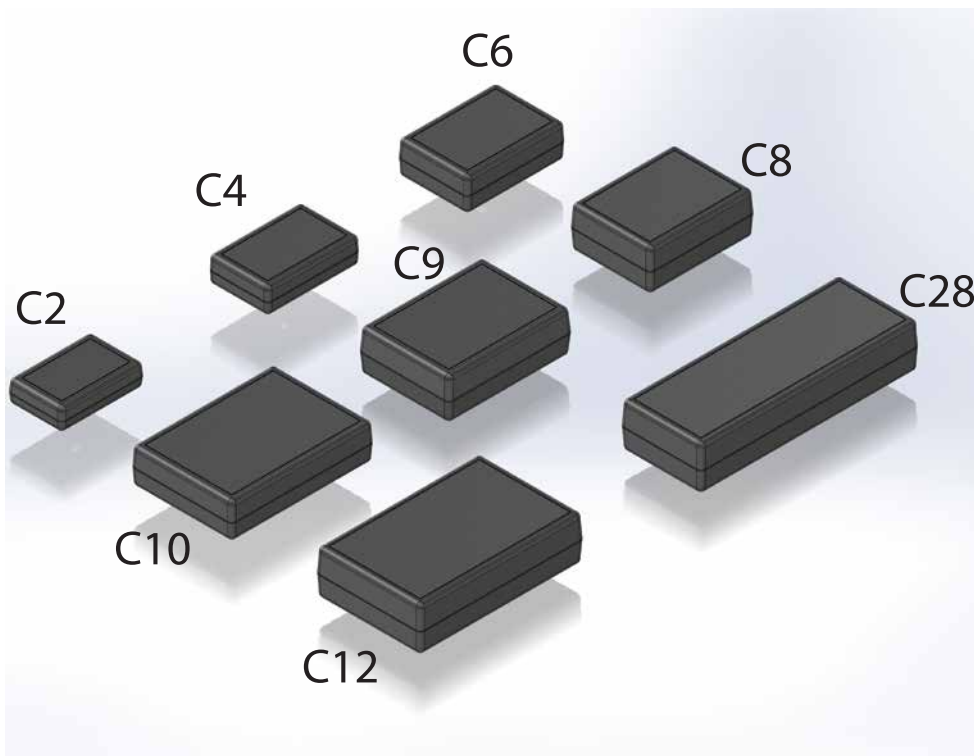

Model	L (in.)	W (in.)	H (in.)
C2	1.25	1.90	0.50
C4	2.13	1.38	0.58
C6	2.26	1.61	0.75
C8	2.40	1.85	0.93
C9	2.93	2.08	0.93
C10	2.30	3.25	0.80
C12	2.40	3.75	1.00
C28	5.00	1.85	1.00

CA series

Key Fob Enclosures

Standard Design Features

- PCB Mounting Bosses
- 3 Piece Ergonomic Design
- ABS Plastic - Standard
- Lap Joint Design
- IP 66/NEMA 4 (CA6, 8 & 10)
- 0-6 Buttons (Depending on Model)
- Includes Key Attachment/Ring
- All Models will hold 20mm coin Batteries (CA10 will hold 2AAA Batteries)

Material

- ABS - UL94HB

Options\ Accessories:

- Membrane Seal (Waterproofing) (CA 6, 8 and 10)
- Machining
- Pad/Full Color Printing Enclosure Only
- EMI Shielding: Spray or Molded

Color *



*All Keypads & Membranes are black

- Custom Colors and Combinations available

CA10B3



CA8B3



CA6B3



CA4B3



Model	L (in.)	W (in.)	H (in.)
CA4B2	2.48	1.73	0.60
CA4B3	2.48	1.73	0.60
CA4B4	2.48	1.73	0.60
CA6B0	3.01	1.45	1.07
CA6B1	3.01	1.45	1.07
CA6B2	3.01	1.45	1.07
CA6B3	3.01	1.45	1.07
CA6B4	3.01	1.45	1.07
CA8	3.27	1.81	1.02
CA8B1	3.27	1.81	1.02
CA8B2	3.27	1.81	1.02
CA8B3	3.27	1.81	1.02
CA8B4	3.27	1.81	1.02
CA8B5	3.27	1.81	1.02
CA10	3.32	2.47	1.08
CA10B1	3.32	2.47	1.08
CA10B2	3.32	2.47	1.08
CA10B3	3.32	2.47	1.08
CA10B4	3.32	2.47	1.08
CA10B5	3.32	2.47	1.08
CA10B6	3.32	2.47	1.08

Standard Design Features

- 2 Piece Rounded Design
- Single Screw Assembly
- Accepts .031 or .062 circuit boards
- ABS Plastic - Standard
- Lap Joint Design
- IP 40/Nema 1 rated
- Boss for Self Tapping Screws

Material

- ABS - UL94HB

Options\ Accessories:

- Machining
- Pad/ Full Color Printing
- Brass Threaded Inserts
- EMI Shielding: Spray or Molded
- Pocket Clip
- Flexible Key Holder

Color

- Black
- Grey
- Almond

- Custom Colors and Combinations available

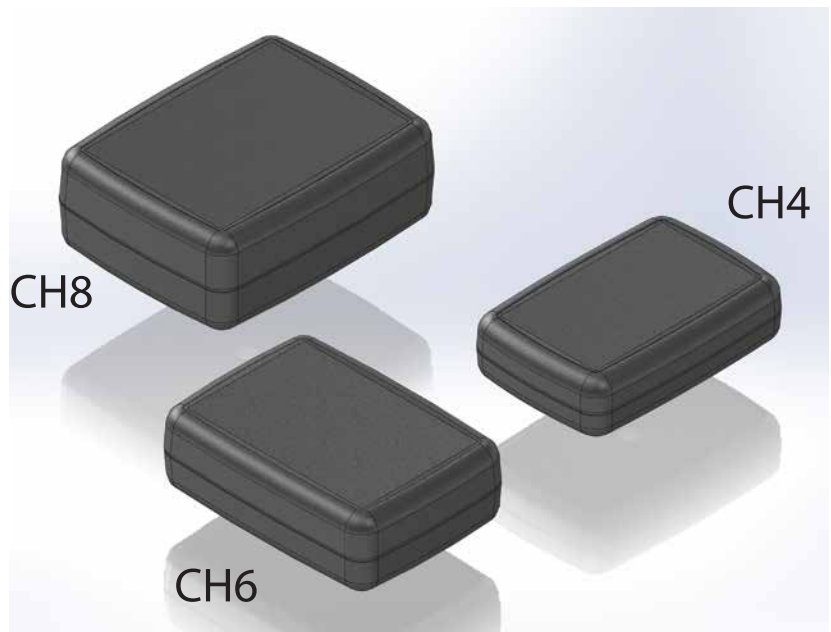

Model	L (in.)	W (in.)	H (in.)
CH4	2.27	1.52	0.59
CH6	2.39	1.74	0.76
CH8	2.58	2.02	0.93



CH6 with Key Holder

G series

Switch/Outlet Box Enclosures

Standard Design Features

- PCB Mounting Bosses
- 2 Piece Potting Box Design
- ABS Plastic - Standard
- Single, Double, and Triple Gang Box Mounting
- Bosses for Self Tapping Screws
- Secured Cosmetic Cover
- Potable Base

Material

- ABS - UL94HB

Options\Accessories:

- Wallmount
- Machining
- Pad/Full Color Printing
- Brass Threaded Inserts
- EMI Shielding: Spray or Molded

Color

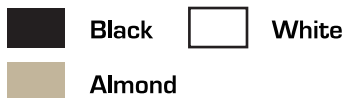

- Custom Colors and Combinations available

Model	L (in.)	W (in.)	H (in.)	Size
G10	4.38	3.25	0.89	Single Gang
G10V*	4.98	3.85	0.89	Single Gang
G20	4.38	5.06	0.89	Double Gang
G30	4.38	6.87	0.89	Triple Gang

*V Model Includes Ventilation Slots

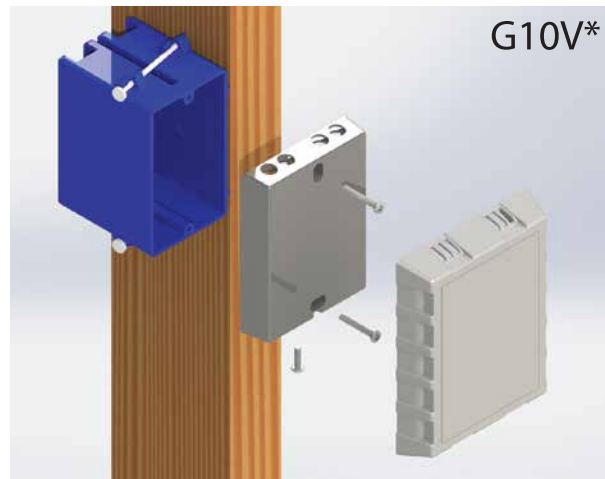

*Box shown for illustration only

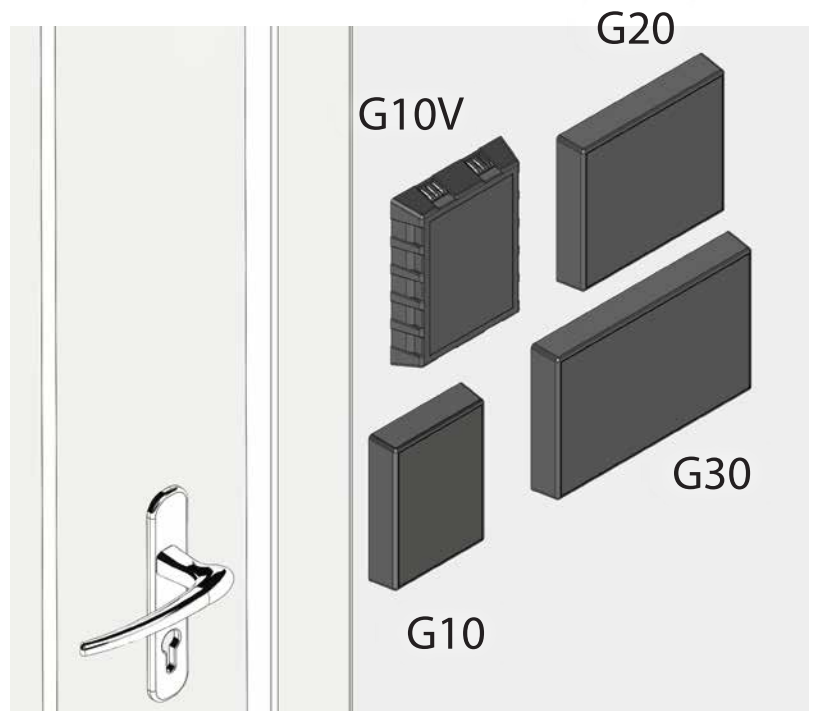

Standard Design Features

- PCB Mounting Bosses
- 3 Piece Design
- ABS Plastic - Standard
- Replaceable End Panels
- Ergonomic Handheld Design
- Multiple Battery Configurations
- 4 or 6 screw Assembly
- Bosses for Self Tapping Screws
- AC Models include Access Panels
- Powered Options Include Battery Contacts with Solder Tab

Material

- ABS - UL94HB

End Panel Accessories:

- Infrared, Clear, DB9/DB25, Standard, Custom
- Rubber Boot (H65)
- Pocket Clip
- Machining
- Pad/Full Color Printing
- Brass Threaded Inserts
- Adjustable Height PCB Bosses
- EMI Shielding: Spray or Molded

Color

Enclosures

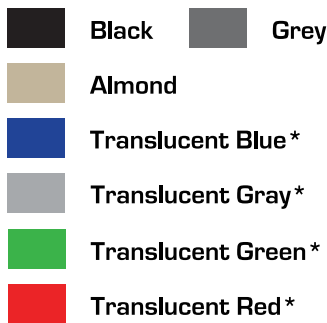

*Standard for H65, H65AA and H659V.

End Panels



- Custom Colors and Combinations available

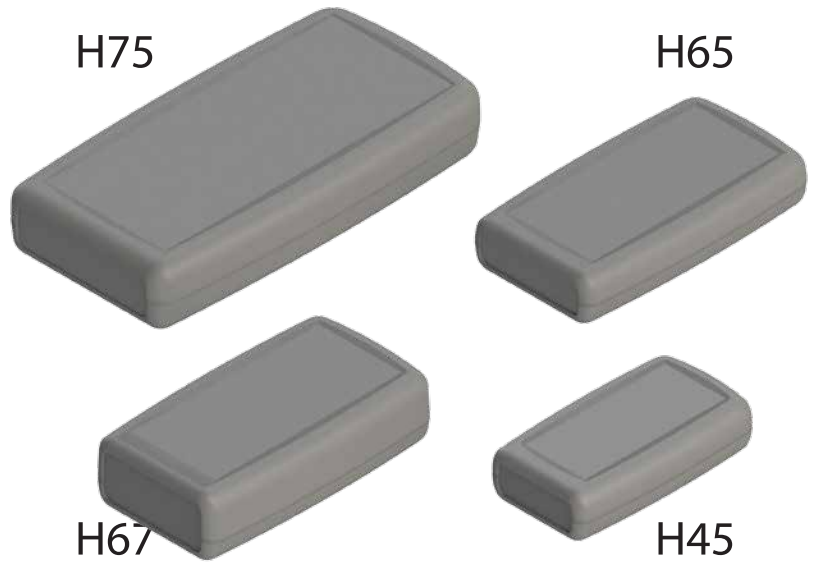

Model	L (in.)	W (in.)	H (in.)	Power
H45	3.90	2.20	0.94	
H45AAA	3.90	2.20	0.94	2(AAA)
H65	4.94	2.75	0.94	
H65AA	4.94	2.75	0.94	2(AA)
H659V	4.94	2.75	0.94	1(9V)
H65AC	4.94	2.75	0.94	AC
H67	4.94	2.75	1.28	
H67AA	4.94	2.75	1.28	2(AA)
H679V	4.94	2.75	1.28	1(9V)
H67AC	4.94	2.75	1.28	AC
H75	7.20	3.65	1.20	
H75AA	7.20	3.65	1.20	2(AA)
H754AA	7.20	3.65	1.20	4(AA)
H759V	7.20	3.65	1.20	1(9V)

Fits Model	Infrared	Clear	Trans. Red
H45	2104IR	2104CL	2104R
H65	2105IR	2105CL	2105R
H67	2106IR	2106CL	2106R
H75	2107IR	2107CL	2107R

*All End Panels are .050 Thick

H series

H65 Enclosure Boot and End Panels

Standard Design Features

- Elastomer Shock Absorbing Boot
- Harsh Environment Protection
- Slip On Design
- Ergonomic Handheld Design



* Does not Include Enclosure

Color



Clear and Trans Red Panel Characteristics

- Dielectric Strength: 85 KV/mil
Continuous operating temperature: -50°C (-58°F) to 74°C (165°F)

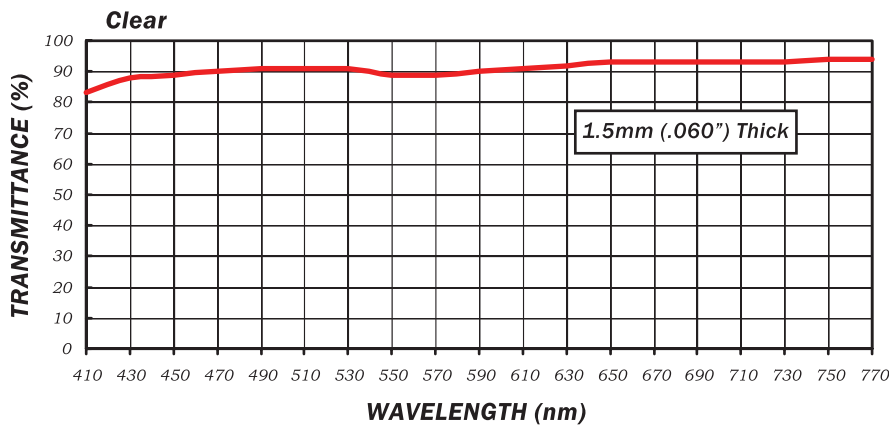

Infrared Panel Characteristics

- Dielectric Strength: 380 V/mil
Continuous operating temperature: -129°C (-200°F) to 276°C (310°F)

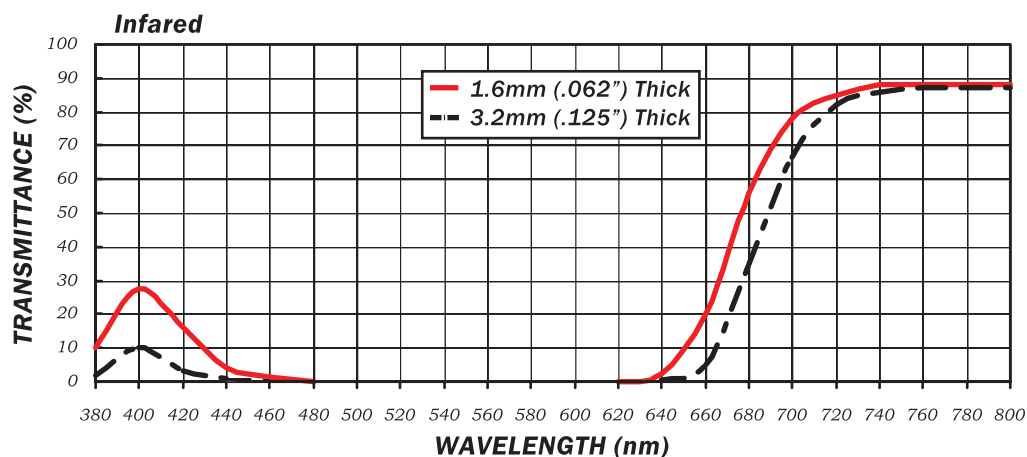

85% Transmittance
@ 715 nm (.062" Th)

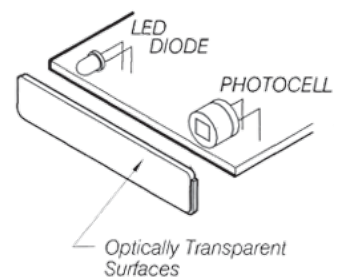

I series

Hinged Watertight Enclosures

Standard Design Features

- Mounting Bosses in Base
- UV Stabilized Polycarbonate
- Three Lid Fastening Options - I342, I352
- Two Lid Fastening Options - I152
- One Lid Fastening Option - I652
- Clear or Solid Colors
- Meets or Exceeds IP 67/NEMA 4

Material

- Polycarbonate - UV Stabilized UL94 V-0



I352HS
Hinged Screw Top

Options \ Accessories:

- Rubber Feet
- Locking Latches
- Mounting Brackets
- Aluminum Panels
- Plastic Panels

Color



- Custom Colors and Combinations available

Model	L (in.)	W (in.)	H (in.)
I152HL	9.71	8.23	5.46
I152HS	9.71	8.23	5.46
I342HL	11.75	10.23	5.46
I342HS	11.75	10.23	5.46
I342S	11.75	10.23	5.46
I352HL	11.75	10.23	7.46
I352HS	11.75	10.23	7.46
I352S	11.75	10.23	7.46
I602HL	17.75	16.27	4.28
I632HL	17.75	16.27	9.33
I652HL	17.75	16.27	11.13





Latch Options

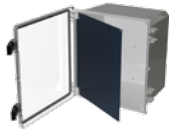
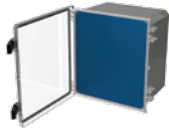

Safety Lock

Plastic Lock

Metal Lock

	I152	I342	I352	I652
 Plastic Hinged Panel	7100HP	7200HP	7200HP	7300HP
 Alum. Hinged Panel	7100TH	7200TH	7200TH	7300TH
 Top Mount Alum. Panel	7100T	7200T	7200T	7300T
 Bottom Mount Alum. Panel	7100B	7200B	7200B	7300B
 Standard Mounting Bracket	1305	1305	1305	n/a
 Corner Feet	1306	1306	1306	1306
 Corner Mounting Bracket	1355	1355	1355	1355

M series

Handheld Remote Enclosures

Standard Design Features

- PCB Mounting Bosses
- 4 Piece Design
- ABS Plastic - Standard
- Customizable Faceplate
- 9V, Single and Double AA Battery Contacts Included Depending on Model
- Handheld
- Easy 2 Screw Assembly
- IND Model Includes Screws Through Battery Cover

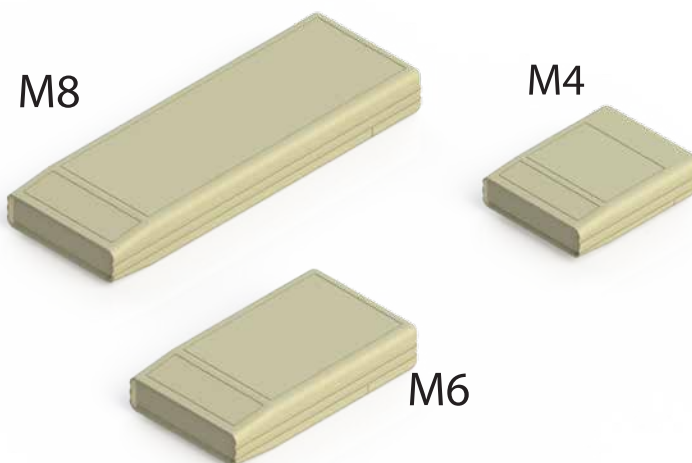

Material

- ABS - UL94HB

End Panel\Accessories:

- Infrared, Clear, 9V Battery, Standard, Custom
- Pocket Clip
- Machining
- Pad/Full Color Printing
- Threaded Inserts
- EMI Shielding: Spray or Molded
- 5 Customizable I Plate Areas

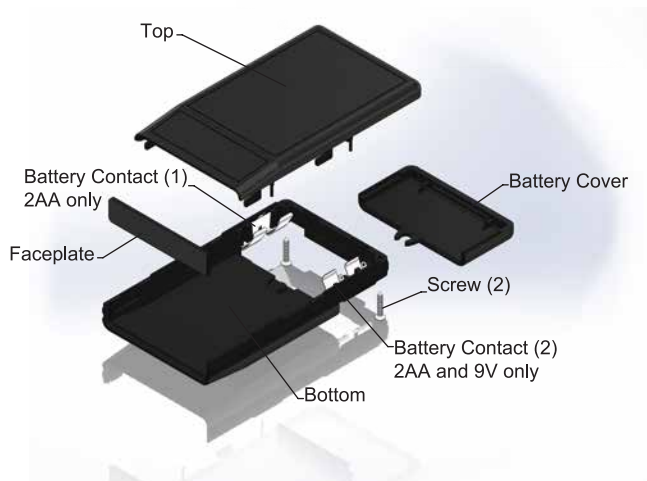

Color

- Black
- Grey
- Almond
- Translucent Blue*
- Translucent Gray*
- Translucent Green*
- Translucent Red*

*Standard for M4 & M6.

End Panels

- Clear
- IR
- Transparent Red

- Custom Colors and Combinations available

Model	L (in.)	W (in.)	H (in.)	Power
M4	2.80	2.20	0.71	1(AA)
M6	4.15	2.40	0.85	2(AA)/1(9V)
M6IND	4.15	2.40	0.85	2(AA)/1(9V)
M8	6.97	2.40	0.85	2(AA)/1(9V)
M8IND	6.97	2.40	0.85	2(AA)/1(9V)

Model	Infrared	Clear	Trans. Red
M4	4004IR	4004CL	4004R
M6	4008IR	4008CL	4008R
M8	4008IR	4008CL	4008R

Standard Design Features

- PCB Mounting Bosses
- Removable Faceplate
- Impact Resistant Polyester
- Intergrated Pistol Grip Handle
- Meets or exceeds IP 66/Nema 4X
- Threaded Inserts for Faceplate Mount
- Includes Wallmount, Screws and Gland/Pigtail

Applications

- Industrial Control
- Remote Control
- Automation

Material

- Polyester - UL94HB

Color



- Custom Colors and Combinations available

Options/Accessories:

- Machining
- Pad/Full Color Printing
- EMI Shielding: Spray

Gland/Strain Relief

- Available in Black
- PG16 Thread
- Available in Two Internal Ø's
 - .260 - .545
 - .180 - .400

Model	L (in.)	W (in.)	H* (in.)
P24	3.96	4.53	11.79
P26	3.96	3.13	13.19
P30	3.96	6.62	13.43

*Without gland. With gland +3.94 in.



(exploded view)

RB series

Watertight Instrument Enclosures

Standard Design Features

- PCB Mounting Bosses
- 2 Piece Design
- UV Stabilized Polycarbonate
- Lap Joint Design
- IP 40/Nema 1 rated w/o O-Ring
- Meets or exceeds IP 67/NEMA 4x, MIL-STD-810G 506.5 when O-Ring is installed
- Threaded Inserts in Base
- Machine Screws and O-ring Included

Material

- Polycarbonate - UV Stabilized UL94V-0

Options \ Accessories:

- Perimeter Seal (Waterproofing)
- Rubber Feet
- Brass Threaded Inserts

Color



- Custom Colors and Combinations available

Standard



Flanged



RB53FP06C16B

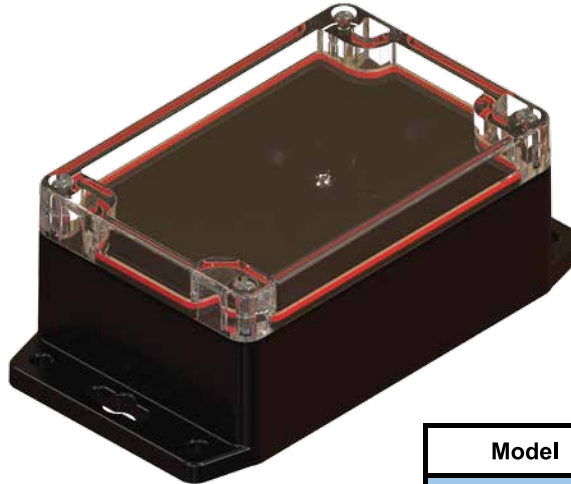

RB53P06C16G

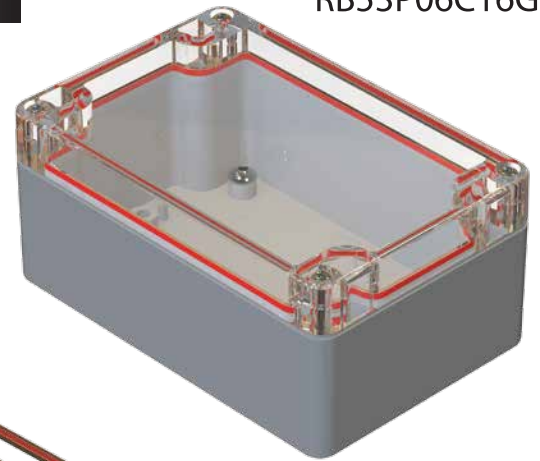

Model	L (in.)	W (in.)	H (in.)
RB22-P04C10C	2.05	1.97	1.38
RB32-P04C08C	2.55	1.97	1.18
RB32-P04C10C	2.55	1.97	1.38
RB33-P06C08C	3.22	3.15	1.38
RB33-P06C16C	3.22	3.15	2.17
RB33-P06C28C	3.22	3.15	3.35
RB53-P06C10C	4.72	3.15	1.59
RB53-P06C16C	4.72	3.15	2.17
RB53-P06C28C	4.72	3.15	3.35
RBF53-P06C16C	4.75	3.18	2.17
Across Flanges:			5.92
RB55-P06C10C	4.72	4.72	1.59
RB55-P06C16C	4.72	4.72	2.17
RB55-P06C28C	4.72	4.72	2.95
RB55-P14C10C	4.72	4.72	2.38
RB55-P14C16C	4.72	4.72	2.95
RB55-P14C28C	4.72	4.72	4.13
RB63-P06C16C	6.30	3.15	2.17
RB63-P06C28C	6.30	3.15	3.35
RB66-P06C16C	6.30	6.30	2.17
RB66-P06C28C	6.30	6.30	3.35
RB85-P06C10C	7.87	4.72	1.59
RB85-P12C10C	7.87	4.72	2.18
RB85-P06C24C	7.87	4.72	2.95
RB85-P12C24C	7.87	4.72	3.54

Standard Design Features

- PCB Mounting Bosses
- 2 Piece Design
- ABS Plastic - Standard
- Lap Joint Design
- IP 40/Nema 1 rated
- IP 67/NEMA 4x and MIL-STD-810G 506.5 Certified when Perimeter Seal is installed
- Bosses for Self Tapping Screws

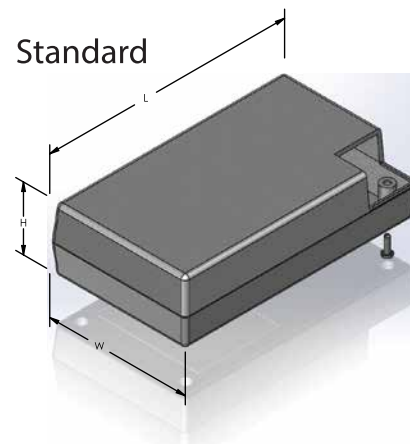

“R” Design Features

- Includes all Features of the Standard
- Choose the R feature if you need repeated removal of the top. The R series includes threaded inserts in the base to allow multiple installation and removal cycles

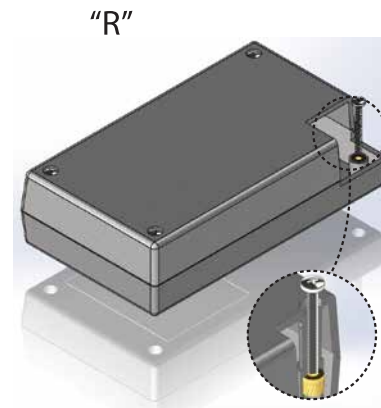

“I” (I Plate) Design Features

- Includes all Features of the Standard
- The I feature is ideal for Printing, Labeling or Membrane Keypads. The I feature includes a .015 Recessed, Untextured Surface. User Insertable Area [See Customization Page #18]

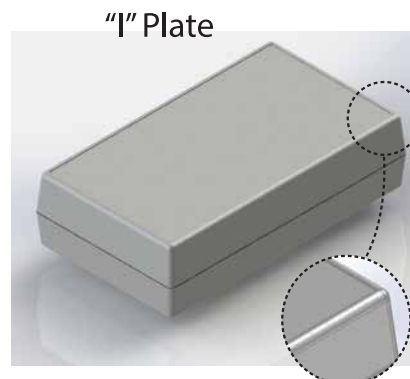

Material

- ABS - UL94HB

Color



- Custom Colors and Combinations available

S series

Model	L (in.)	W (in.)	H (in.)	Standard		R	
				Texture	I Plate	Texture	I Plate
110	3.60	2.25	1.00		110 i		110 Ri
111	3.60	2.25	1.50	111	111 i	111 R	111 Ri
112	3.60	2.25	2.00	112	112 i	112 R	112 Ri
113	3.60	2.25	2.50	113	113 i	113 R	113 Ri
021	4.10	2.60	0.90	021	021 i		
022	4.10	2.60	1.40	022	022 i		
121	4.10	2.60	1.50	121	121 i	121 R	121 Ri
023	4.10	2.60	1.90	023	023 i		
122	4.10	2.60	2.00	122	122 i	122 R	122 Ri
123	4.10	2.60	2.50	123	123 i	123 R	123 Ri
032	4.38	3.25	1.40	032	032 i		
031	4.38	3.25	0.09	031	031 i		
131	4.38	3.25	1.50	131	131 i	131 R	131 Ri
033	4.38	3.25	1.90	033	033 i		
132	4.38	3.25	2.00	132	132 i	132 R	132 Ri
133	4.38	3.25	2.50	133	133 i	133 R	133 Ri
051	5.62	3.25	0.90	051	051 i		
052	5.62	3.25	1.40	052	052 i		
151	5.62	3.25	1.50	151	151 i	151 R	151 Ri
053	5.62	3.25	1.90	053	053 i		
152	5.62	3.25	2.00	152	152 i	152 R	152 Ri
153	5.62	3.25	2.50	153	153 i	153 R	153 Ri
055	5.62	3.25	2.78		055 i		
155	5.62	3.25	3.38		155 i		
071	6.88	4.88	0.90	071	071 i		
072	6.88	4.88	1.40	072	072 i		
171	6.88	4.88	1.50	171	171 i	171 R	171 Ri
073	6.88	4.88	1.90	073	073 i		
172	6.88	4.88	2.00	172	172 i	172 R	172 Ri
173	6.88	4.88	2.50	173	173 i	173 R	173 Ri
091	9.50	6.34	0.90	091	091 i		
092	9.50	6.34	1.40	092	092 i		
191	9.50	6.34	1.50	191	191 i	191 R	191 Ri
093	9.50	6.34	1.90	093	093 i		
192	9.50	6.34	2.00	192	192 i	192 R	192 Ri
094	9.50	6.34	2.40	094	094 i		
193	9.50	6.34	2.50	193	193 i	193 R	193 Ri
194	9.50	6.34	3.00	194	194 i	194 R	194 Ri
182	14.21	4.88	2.00	182	182 i	182 R	182 Ri

Options\Accessories:

- Perimeter Seal (Waterproofing) (except for 9V)
- Pocket Clip
- Rubber Feet
- Clad or Grid Circuit Boards
- Wallmount (Select models)
- 2AA Battery Holder (select models)
- Brass Threaded Inserts

Applications

- Test Equipment
- Computer Interface
- Field Measurement
- Prototype Box
- Industrial Control
- Telecommunications
- Embedded Applications



IP67 w/ Perimeter Seal

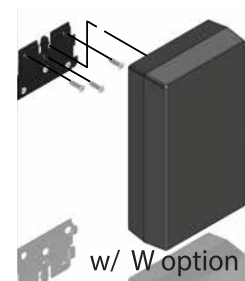

w/ W option

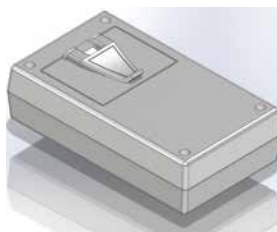

w/ Pocket Clip

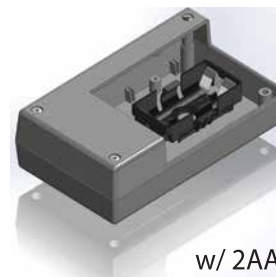

w/ 2AA

Clear Cover

Model	L (in.)	W (in.)	H (in.)	Standard	"R"
032C	4.38	3.25	1.40	032 C	
132C	4.38	3.25	2.00	132 C	132 RC
052C	5.62	3.25	1.40	052 C	
152C	5.62	3.25	2.00	152 C	152 RC
072C	6.88	4.88	1.40	072 C	
172C	6.88	4.88	2.00	172 C	172 RC
093C	9.50	6.34	1.90	093 C	
193C	9.50	6.34	2.50	193 C	193 RC

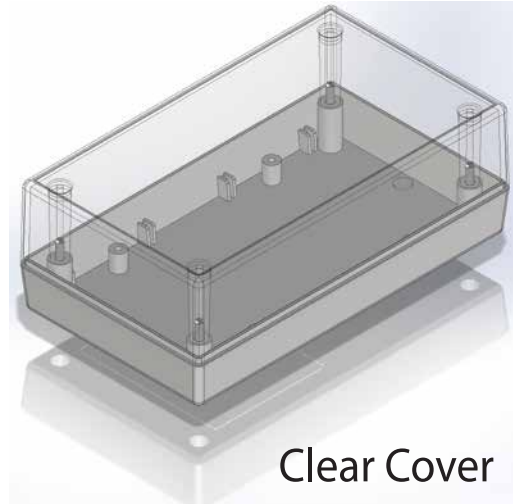

9V Battery Powered w/ Clear Cover

Model	L (in.)	W (in.)	H (in.)	Standard	"R"
232 C	4.38	3.25	2.00	232 C	232 RC
233 C	5.62	3.25	2.00	252 C	252 RC
272 C	6.88	4.88	2.00	272 C	272 RC

*9V Models Meet or Exceed IP40/Nema 1

9V Battery Powered

Model	L (in.)	W (in.)	H (in.)	Standard		R	
				Standard	I Plate	"R"	I Plate
221	4.10	2.60	1.50	221	221 i	221 R	221 Ri
222	4.10	2.60	2.00	222	222 i	222 R	222 Ri
223	4.10	2.60	2.50	223	223 i	223 R	223 Ri
231	4.38	3.25	1.50	231	231 i	231 R	231 Ri
232	4.38	3.25	2.00	232	232 i	232 R	232 Ri
233	4.38	3.25	2.50	233	233 i	233 R	233 Ri
251	5.62	3.25	1.50	251	251 i	251 R	251 Ri
252	5.62	3.25	2.00	252	252 i	252 R	252 Ri
253	5.62	3.25	2.50	253	253 i	253 R	253 Ri
255	5.62	3.25	3.38		255 i		
271	6.88	4.88	1.50	271	271 i	271 R	271 Ri
272	6.88	4.88	2.00	272	272 i	272 R	272 Ri
273	6.88	4.88	2.50	273	273 i	273 R	273 Ri

*9V Models Meet or Exceed IP40/Nema 1

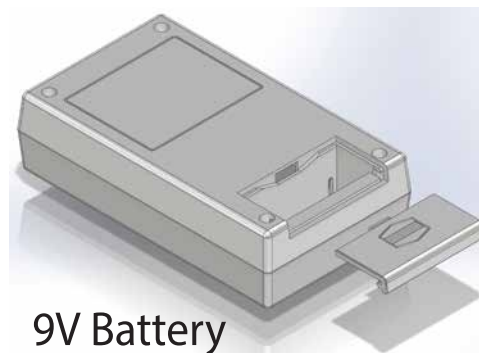

SL series

Sloping Enclosures

Standard Design Features

- PCB Mounting Bosses
- Recessed I Plate on Top
- 2 Piece Design with Slanted Top
- ABS Plastic - Standard
- Lap Joint Design
- IP 40/Nema 1 rated
- Meets or Exceeds IP 67/NEMA 4x MIL-STD-810G 506.5 rated when PSXX is installed
- Bosses for Self Tapping Screws

Material

- ABS - UL94HB

Options\Accessories:

- Perimeter Seal (Waterproofing)
- Rubber Feet
- Clad or Grid Circuit Boards
- Wallmount (Select models)
- Machining
- Pad/Full Color Printing
- Brass Threaded Inserts
- EMI Shielding: Spray or Molded

Color



- Custom Colors and Combinations available

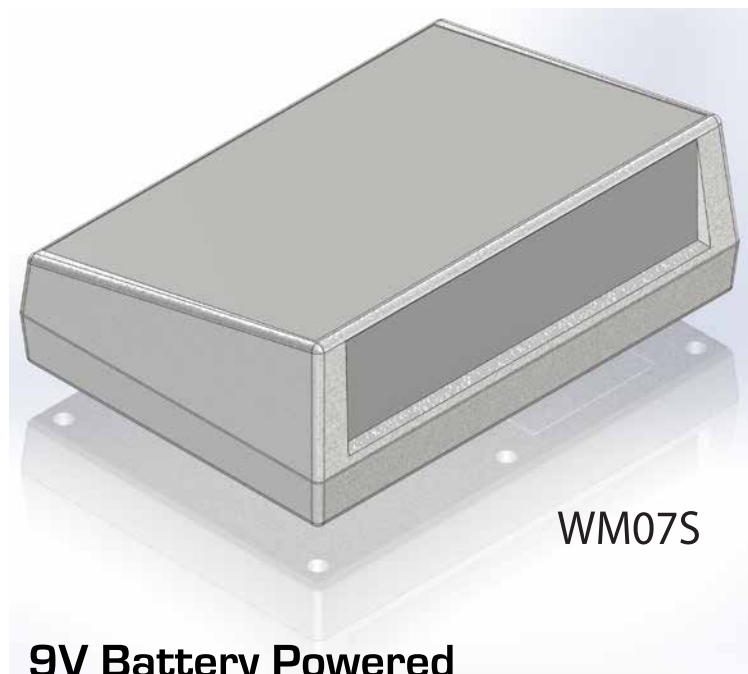
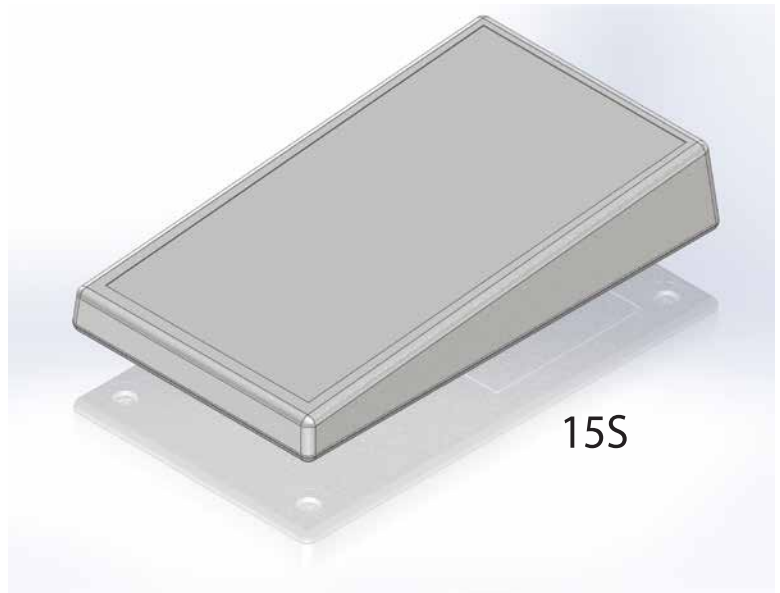

Model	L (in.)	W (in.)	H (in.)
05S	3.28	3.28	0.90
15S	4.10	3.28	1.50
07S	6.89	4.89	1.87
17S	6.89	4.89	2.45
WM05S	5.65	3.28	1.10
WM07S	6.89	4.89	2.05

9V Battery Powered

Model	L (in.)	W (in.)	H (in.)
25S	4.10	3.28	1.50
27S	6.89	4.89	2.45

*9V Models Meet or Exceed IP40/Nema 1

Standard Design Features

- PCB Mounting Bosses
- 2 Piece Design
- ABS Plastic - Standard
- Lap Joint Design
- IP 40/Nema 1 rated
- IP 67/NEMA 4x and MIL-STD-810G 506.5 Certified when Perimeter Seal is installed
- Bosses for Self Tapping Screws

"R" Design Features

- Includes all Features of the Standard
- Choose the R feature if you need repeated removal of the top. The R series includes threaded inserts in the base to allow multiple installation and removal cycles

"I" (I Plate) Design Features

- Includes all Features of the Standard
- The I feature is ideal for Printing, Labeling or Membrane Keypads. The I feature includes a .015 Recessed, Untextured Surface. User Insertable Area [See Customization Page #18]

Material

- Standard Material: ABS - UL94HB

Color



- Custom Colors and Combinations available

Model	L (in.)	W (in.)	H (in.)	Standard		R	
				Standard	I Plate	"R"	I Plate
WM010	4.61	2.32	0.60		WM010i		WM010Ri
WM011	4.61	2.32	1.10	WM011	WM011i	WM011R	WM011Ri
WM012	4.61	2.32	1.60	WM012	WM012i	WM012R	WM012Ri
WM013	4.61	2.32	2.10	WM013	WM013i	WM013R	WM013Ri
WM021	5.09	2.65	1.10	WM021	WM021i	WM021R	WM021Ri
WM022	5.09	2.65	1.60	WM022	WM022i	WM022R	WM022Ri
WM023	5.09	2.65	2.10	WM023	WM023i	WM023R	WM023Ri
WM031	5.37	3.30	1.10	WM031	WM031i	WM031R	WM031Ri
WM032	5.37	3.30	1.60	WM032	WM032i	WM032R	WM032Ri
WM033	5.37	3.30	2.10	WM033	WM033i	WM033R	WM033Ri
WM051	6.62	3.30	1.10	WM051	WM051i	WM051R	WM051Ri
WM052	6.62	3.30	1.60	WM052	WM052i	WM052R	WM052Ri
WM053	6.62	3.30	2.10	WM053	WM053i	WM053R	WM053Ri
WM055	6.62	3.30	2.98		WM055i		
WM071	7.87	4.93	1.10	WM071	WM071i	WM071R	WM071Ri
WM072	7.87	4.93	1.60	WM072	WM072i	WM072R	WM072Ri
WM073	7.87	4.93	2.10	WM073	WM073i	WM073R	WM073Ri
WM091	10.49	6.39	1.10	WM091	WM091i	WM091R	WM091Ri
WM092	10.49	6.39	1.60	WM092	WM092i	WM092R	WM092Ri
WM093	10.49	6.39	2.10	WM093	WM093i	WM093R	WM093Ri
WM094	10.49	6.39	2.60	WM094	WM094i	WM094R	WM094Ri

WM Clear

Model	L (in.)	W (in.)	H (in.)	Standard	"R"
WM032C	5.37	3.30	1.60	WM032C	WM032RC
WM052C	6.62	3.30	1.60	WM052C	WM052RC
WM072C	7.87	4.93	1.60	WM072C	WM072RC
WM093C	10.49	6.39	2.10	WM093C	WM093RC

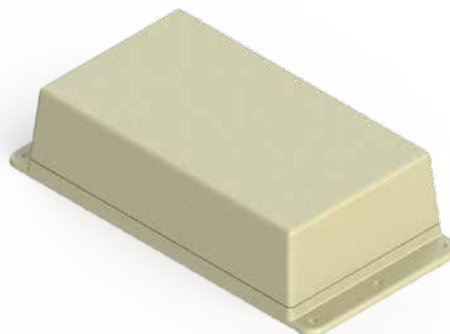

Options \ Accessories:

- Perimeter Seal (Waterproofing) (except for 9V)
- Pocket Clip
- Rubber Feet
- Clad or Grid Circuit Boards
- Wallmount (Select models)
- 2AA Battery Holder (select Models)
- Brass Threaded Inserts

Protective Cases

Protective Equipment Cases

Standard Design Features

- Mounting Bosses
- Hinged Design
- Polypropylene - Standard*
- Lap Joint Design
IP 67/NEMA 4x, 12, 13 and MIL-STD-810G 506.5 Rated
- Bosses for Self Tapping Screws on Select Models
- Secured Cosmetic Cover

*SE56 - Polycarbonate



Material

- Polypropylene
- Polycarbonate (SE56)

Options\Accessories:

- Foam
- Machining
- Brass Threaded Inserts
- EMI Shielding: Spray



External Dimensions				Available Colors								
Model	L (in.)	W (in.)	H (in.)	Black	Yellow	Orange	Gunmetal	Desert Tan	Blue	Green	Red	Clear
52*	6.31	4.48	2.10									
120	8.80	7.75	3.90									
130	8.84	7.43	4.11									
56*	9.48	5.80	2.77									
300/300FP1	10.78	9.75	4.83									
230	11.85	8.45	4.74									
430/430FP2	13.60	10.72	6.28									
540/540FP4	14.95	12.13	9.58									
530	15.04	12.41	6.98									
85/85FP2*	15.09	12.16	2.79									
520	15.27	12.13	6.69									
630/630HPS	17.54	14.24	7.50									
630FP4	17.54	14.24	7.50									
710	20.10	15.53	5.30									
710CC	20.10	15.53	5.30									
710XCC	20.10	15.53	5.30									
720/720CC	20.10	15.53	7.34									
830	21.90	13.90	8.90									
920	24.30	16.00	10.10									
1220	27.90	22.27	15.10									
1530	46.60	16.70	6.80									
1630	57.31	18.48	8.39									
1660	57.31	18.48	14.39									

Padded Divider

Available for 520, 540*, 720, 830, 920, and 1220 cases
 Compartments are adjustable, padded Velcro separators allow for configuration of compartments.

Fits	Part No.
SE520	9501
SE720	9701
SE920	9901
SE1220	9921



Padded Shoulder Carry Strap

This shoulder strap is padded and includes quick release snap connectors on each end. The snap connectors are engineered to fit holes on the SE540, SE710, and SE720.



Part No. 8704

Mesh Lid Organizer

Available for 710, 720, 830, 920, and 1220 cases
 Zippered pouches feature Nylon mesh pockets so contents are easily seen and accessed.



Fits	Part No.
SE710/720	8725
SE830	8726
SE920	8727
SE1220	8728

Hinged Panel System (HPS)

Available as SE630HPS or HPS

SE630HPS includes HPS installed in top, Cubed Matrix foam with solid backing for top and bottom, and 1pc user installed adhesive backed convoluted foam for panel. HPS also available as a user installed option for case bottom. Metal Locks (ML) are optional.



Customization Options

Enclosure Modifications

CNC Machining

SERPAC can machine a wide range of openings for your specified geometry and recess any surface to accommodate your labels or membrane switches. We can also machine internal features, including the removal or shortening of circuit board bosses or card guides. Simply provide us with a drawing and we do the rest!

While there are no minimum quantities required, a set-up fee will be applied.

Lead time for machining orders is two days for 1000 pieces or less.



I Plate Customization

All SERPAC enclosures are designed with customization in mind. Each enclosure has "Insert Areas" where a custom "I-Plate" can be made to your specification. Your modifications (characters, symbols, openings, and recesses) can be molded into the box, cutting down your machining costs and adding a custom look to your final product.

These I-Plates have a one time tooling charge and are owned by you, our customer. On some of our products we also have the ability to modify the height of internal bosses to accommodate your specific application.

Some surfaces where internal and external I-Plates exist can be recessed or raised to accommodate your components and or designs. (all H-Series models and other models. Please contact customer service for details)

No minimum order quantity required.

Lead time for molded-in modifications orders is 2 weeks depending on complexity.



Color Options

In addition to our standard enclosure colors, SERPAC can also accommodate custom color requirements, either in translucent or opaque materials. To obtain a quotation on custom colors, send us a color chip or specify a Pantone number.

No minimum order quantity is required.



EMI Shielding

SERPAC enclosures can be customized to shield sensitive electronics from Electromagnetic Interference (EMI). SERPAC offers two different methods for shielding:

Spray method

Enclosures are coated with a conductive nickel based paint.

- There are no minimum quantities required, but a set-up fee will be applied.

Molded method

The second shielding method is to mold enclosures in conductive plastic (black only).

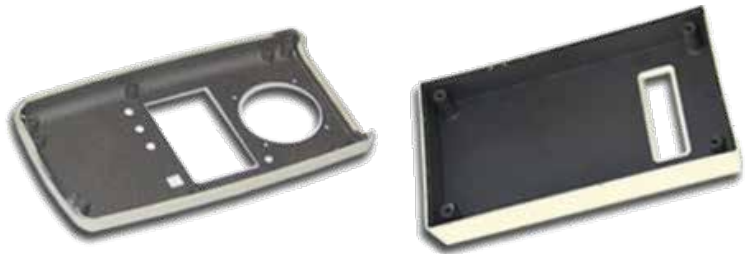

Orders of a 1000 pieces or more will not incur a setup charge.

Printing

PAD Printing Features

Customize your product by having SERPAC print your company logo, graphics, instructions or other text directly onto your enclosure. Multi-color printing jobs are easily handled.



FULL Color Printing Features

Have your Serpac enclosure customized with the latest state of the art digital printing.

This full color process creates a scratch resistant image. Full Color Printing can be used for simple text, gradients, blended colors, color transitions, and photo-quality images.

Have your enclosure customized in 48 hours, on all approved orders less than 1,000 pieces.

Please allow an additional 48 hours on machined orders.

Vector based artwork (designed for the CMYK color space) is required for printing.

While there are no minimum quantities required, a set-up fee will be applied.

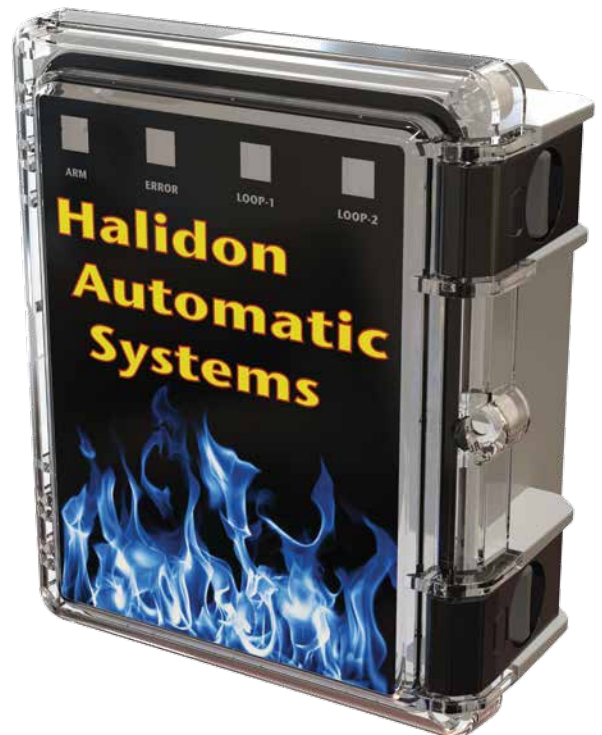

Available Now Online:

SERPACONLINE

SerpacOnline

ALLIED ELECTRONICS



DIGI KEY



MOUSER ELECTRONICS



NEWARK



GM ELECTRONIC



Country	Distributor Name	Address	Phone No.
AUSTRALIA	SWITCHES PLUS	UNIT 1,2 SIBTHORPE STREET BRAESIDE, VICTORIA 3195, 03195-0000	61-139-587-4044
CANADA	ELECTRONIC PACKAGING SYSTEMS	758 FORTUNE CRESCENT, Kingston, ON, K7P 2T3	613-384-1142
UNITED KINGDOM	OKW ENCLOSURES LTD.	UNIT 15 BRUNEL WAY SEGENSWORTH EAST, FAREHAM HAMPSHIRE, PO155TX UK	44-1489-583858
ISRAEL	ARAZIM	4 HAMELACHA ST LOD 71293, LOD	972-8-9230555

Serpac Electronic Enclosures

2009 Wright Ave., La Verne, CA 91750

T: (626) 331.0517 • F: (626) 331.8584 • sales@serpac.com

www.Serpac.com