



FOCUS LCDs

LCDs MADE SIMPLE®

Ph. 480-503-4295 | NOPP@FocusLCDs.com

TFT | OLED | CHARACTER | GRAPHIC | UWVD | SEGMENT | CUSTOM

TFT Display Module

Part Number E144GC-CW230-N

Overview:

- 1.44-inch TFT (42.72x60.06mm)
- MCU Interface
- 128x128 pixels
- 6:00 Viewing Angle
- White LED backlight
- Transmissive/ Normally White
- No Touch Panel
- 230 NITS
- Controller: ST7735S
- RoHS Compliant

Description

This is a color active matrix TFT (Thin Film Transistor) LCD (Liquid Crystal Display) that uses amorphous silicon TFT as a switching device. This model is composed of a transmissive type TFT LCD Panel, driver circuit and a backlight unit. The resolution of the 1.44" TFT LCD contains 128(RGB)x128 pixels and can display up to 262K colors.

TFT Features

Low Input Voltage: 3.3V

Display Colors: 262K

TFT Interface: MCU

General Information Items	Specification	Unit	Note
	Main Panel		
TFT Display area (AA)	25.5(H) x 26.5(V) (1.44 inch)	mm	-
Driver Element	TFT active matrix	-	-
Display Colors	262K	colors	-
Number of pixels	128(RGB)x128	dots	-
TFT Pixel arrangement	RGB vertical stripe	-	-
Pixel Pitch	0.1992(H)x0.207(V)	mm	-
Viewing angle	6:00	-	-
Display mode	Transmissive, Normally White	-	-
TFT Controller	ST7735S	-	-
Operating temperature	-20-+70	°C	-
Storage temperature	-30-+80	°C	-

Mechanical Information

Item		Min	Typ.	Max	Unit	Note
Module Size	Horizontal (H)		30.6		mm	-
	Vertical (V)		34.8		mm	-
	Depth (D)		2.5		mm	-
	Weight		TBD		g	

1. Outline Dimensions

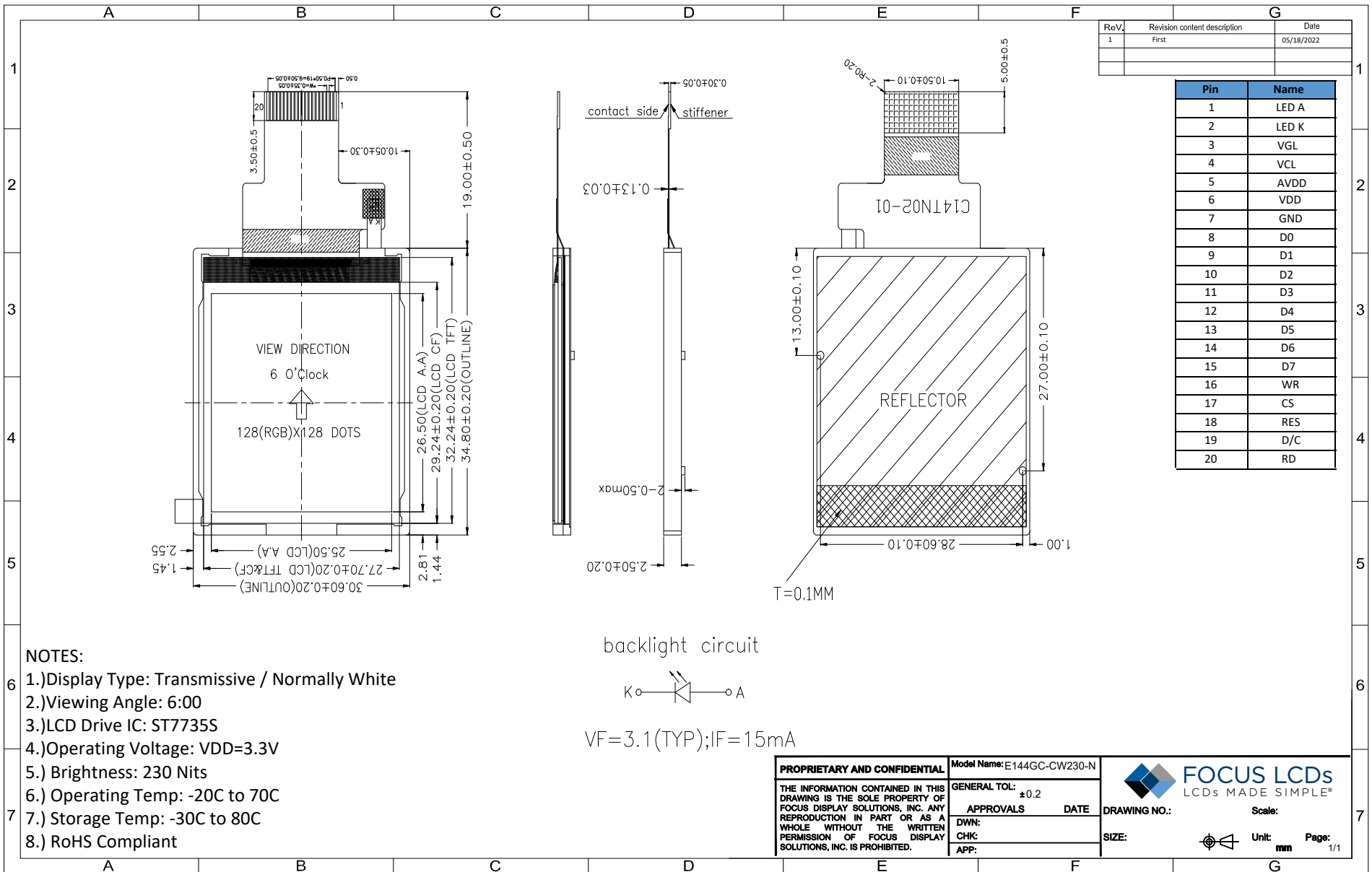

2. Input Terminal Pin Assignment

2.1 TFT

Recommended Connector: FH12-20S-0.5SH(55)

Pin	Name	I/O	Function
1	LED A	P	POWER FOR BACKLIGHT(ANODE)
2	LED K	P	POWER FOR BACKLIGHT(CATHODE)
3	VGL	O	Power Output (Negative) Pin for Gate Driver
4	VCL	O	Power Supply Pin for Generating VCL
5	AVDD	O	Power Pin for Analog Circuits
6	VDD	P	POWER SUPPLY
7	GND	P	POWER GROUND
8-15	D0-D7	I/O	D[17:0] are used as MCU parallel interface data bus. -D0 is the serial input/output signal in serial interface mode. -In serial interface, D[17:1] are not used and should be fixed at VDDI or DGND level.
16	WR	I	-Write Enable in MCU Parallel Interface. -In 4-line SPI, this pin is used as D/CX (data/ command selection). -If not used, please fix this pin at VDDI or DGND level.
17	CS	I	Chip Selection Pin -Low Enable
18	RES	I	This signal will reset the device and it must be applied to properly initialize the chip. -Signal is active low
19	D/C	I	Display data/command Selection Pin in MCU Interface. -D/CX='1': Display Data or Parameter. -D/CX='0': Command Data. -In Serial Interface, this is used as SCL. -If not used, please fix this pin at VDDI or DGND level
20	RD	I	Read Enable in 8080 MCU Parallel Interface. -If not used, please fix this pin at VDDI or DGND level

3. LCD Optical Characteristics

3.1 Optical Specifications

Item		Symbol	Condition	Min	Typ.	Max	Unit	Note
Response time		T_r	$\theta=0^\circ$	-	3	6	ms	BM-7A
		T_f		--	7	14	ms	
Contrast ratio		CR	At Optimized Viewing Angle	400	500	--	--	
Luminance Uniformity		ΔL		70	80		%	
Color Chromaticity (CIE 1931)	White	W_x	$\theta=0^\circ$ Normal Viewing Angle	0.26	0.30	0.34	--	
		W_y		0.28	0.32	0.36		
Viewing Angle	Hor.	θ_R	$CR \geq 10$	60	70	--	Degree	
		θ_L		60	70	--		
	Ver.	θ_U		60	70	--		
		θ_D		50	60	--		

Optical Specification Reference Notes:

(1) Definition of Viewing Angle: The viewing angle is the angle at which the contrast ratio is greater than 10. The viewing angles are determined for the horizontal or 3,9 o'clock direction and the vertical or 6,12 o'clock direction with respect to the optical axis which is normal to the LCD surface.

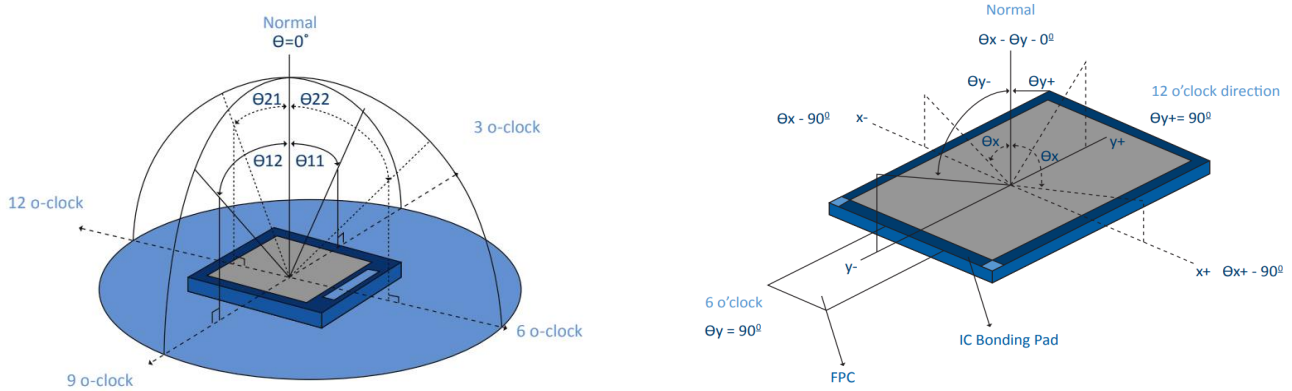

(2) Definition of Contrast Ratio (Cr): measured at the center point of panel. The contrast ratio (Cr) measured on a module, is the ratio between the luminance (Lw) in a full white area (R=G=B=1) and the luminance (Ld) in a dark area (R=G=B=0).

$$Cr = \frac{Lw}{Ld}$$

(3) Definition of transmittance (T%): The transmittance of the panel including the polarizers is measured with electrical driving. The equation for transmittance Tr is:

$$Tr = \frac{I_t}{I_o} \times 100\%$$

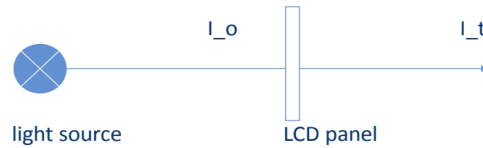

I_o = the brightness of the light source.
 I_t = the brightness after panel transmission

(4) Definition of Response Time (Tr, Tf): The rise time 'Tr' is defined as the time for luminance to change from 90% to 10% as a result of a change of the electrical condition. The fall time 'Tf' is defined as the time for luminance to change from 10% to 90% as a result of a change of the electrical condition.

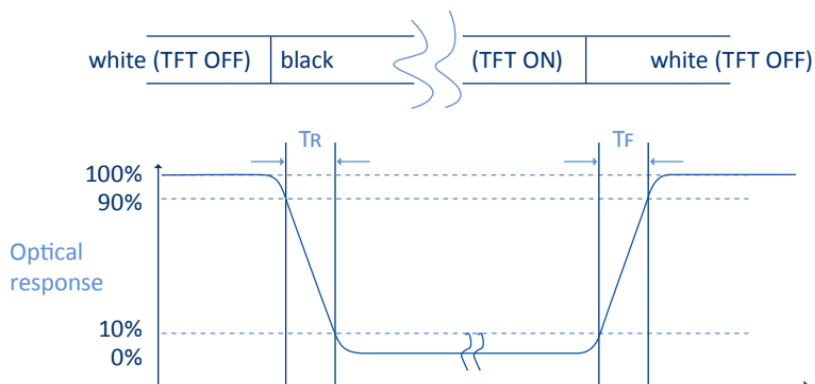

(5) Definition of Color Gamut:

Measuring machine CFT-01. NTSC's Primaries: $R(x,y,Y), G(x,y,Y), B(x,y,Y)$. FPM520 of Westar Display Technologies, INC., which utilized SR-3 for Chromaticity and BM-5A for other optical characteristics. The color chromaticity shall be calculated from the spectral data measured with all pixels first in red, green, blue and white. Measurements shall be made at the center of the panel.

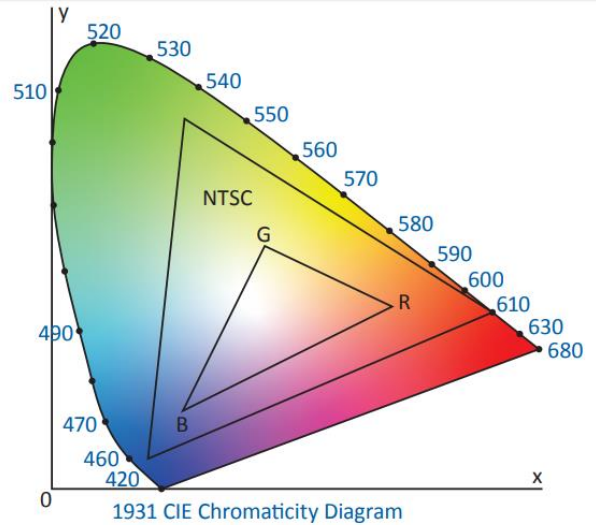
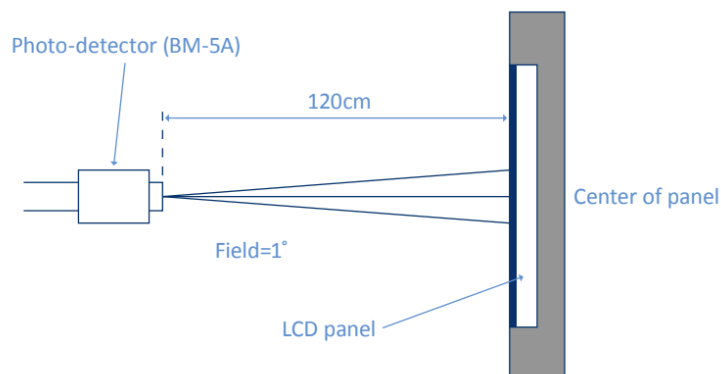
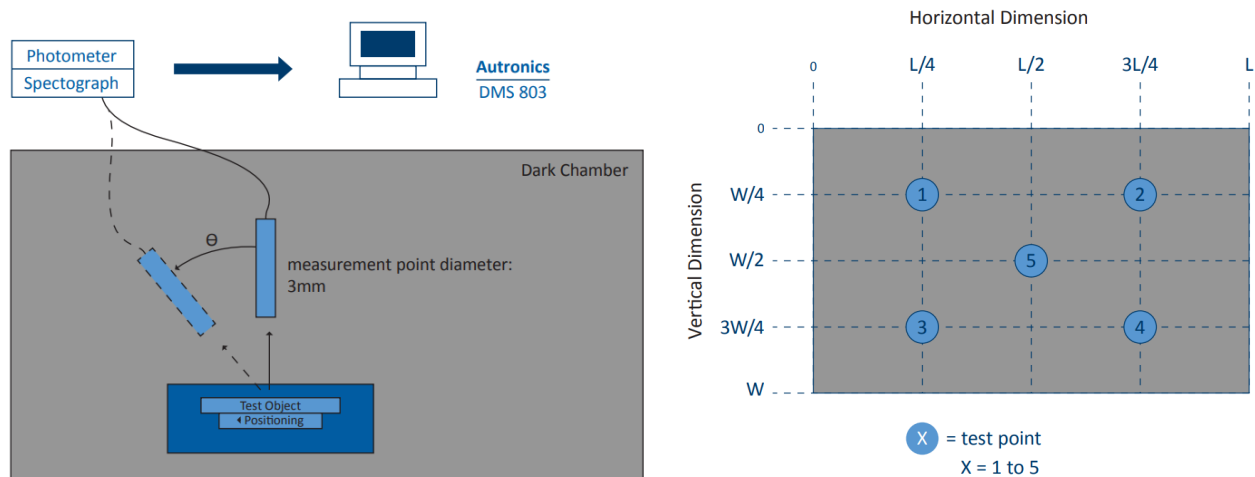

Fig. 1931 CIE chromacity diagram

$$\text{Color gamut: } S = \frac{\text{Area of RGB triangle}}{\text{Area of NTSC triangle}} \times 100\%$$

(6) Definition of Optical Measurement Setup:

The LCD module should be stabilized at a given temperature for 20 minutes to avoid abrupt temperature change during measuring. In order to stabilize the luminance, the measurement should be executed after lighting backlight for 20 minutes.



4. TFT Electrical Characteristics

4.1 Absolute Maximum Rating (Ta=25 °C, VSS=0V)

Characteristics	Symbol	Min	Max	Unit
Digital Supply Voltage	VDD	VSS-0.3	4.6	V

NOTE: If the absolute maximum rating of the above parameters is exceeded, even momentarily, the quality of the product may be degraded. Absolute maximum ratings specify the values which the product may be physically damaged if exceeded. Be sure to use the product within the range of the absolute maximum ratings.

4.2 DC Electrical Characteristics

Characteristics	Symbol	Min	Typ.	Max	Unit	Note
Power supply	VDD	2.5	3.3	3.7	V	
Input Voltage for logic	H Level	VIH	0.7xVDD	-	VDD	V
	L Level	VIL	0	-	0.3xVDD	V
Power Supply current	IDD	-	-	(30)	mA	Note 1

Note1: $f_v = 60\text{Hz}$, $T_a = 25^\circ\text{C}$, Display pattern : Gray pattern

4.3 LED Backlight Characteristics

The backlight system is edge lighting type with a white LED

Item	Symbol	Min	Typ.	Max	Unit	Note
Forward Current	I_F	--	15	--	mA	
Forward Voltage	V_F	2.8	3.0	3.3	V	
LCM Luminance	L_V	--	230	--	cd/m ²	Note 3
LED lifetime	Hr	50000	--	--	hour	Note1 & 2
Uniformity	AVg	80	--	--	%	Note 3

Note 1: LED lifetime (Hr) can be defined as the time in which it continues to operate under the condition: $T_a=25 \pm 3^\circ\text{C}$, typical IL value indicated in the above table until the brightness becomes less than 50%.

Note 2: The "LED lifetime" is defined as the module brightness decrease to 50% original brightness at $T_a=25^\circ\text{C}$ and $I_L = 15\text{mA}$. The LED lifetime could be decreased if operating I_L is larger than 15mA. The constant current driving method is suggested.

backlight circuit

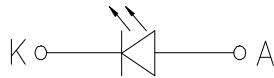

$$V_F = 3.1 (\text{TYP}); I_F = 15\text{mA}$$

Note 3: Luminance Uniformity of these 9 points is defined as below:

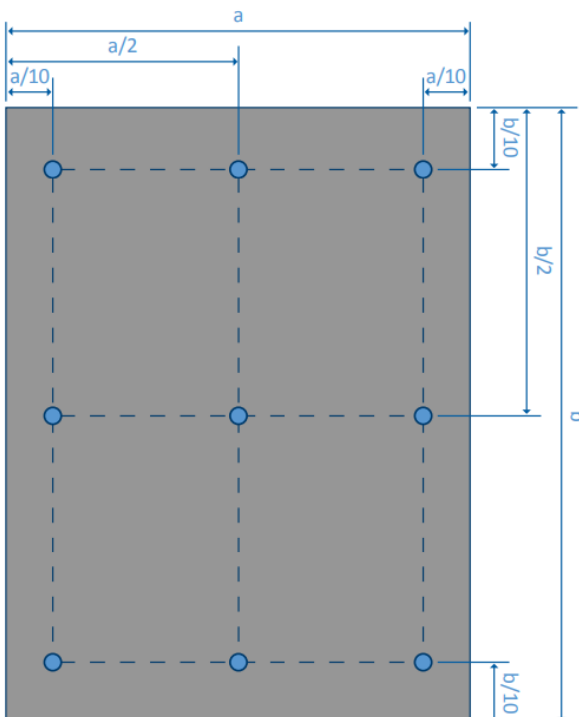

$$\text{Luminance} = \frac{\text{Total Luminance of 9 points}}{9}$$

$$\text{Uniformity} = \frac{\text{minimum luminance in 9 points(1-9)}}{\text{maximum luminance in 9 points(1-9)}}$$

5.0 TFT AC Characteristics

5.1 Interface Timing

For the interface timing diagram, see diagram on page 49 of the data sheet for controller IC ST7735S. The data sheet can be found here <https://focuslcds.com/content/ST7735S.pdf>

6.0 Quality Inspection Standards

For TFT quality inspection standards, please see the following link: <https://focuslcds.com/tft-quality-inspection-standards/>

7.0 Cautions and Handling Precautions

7.1 Handling and Operating the Module

1. When the module is assembled, it should be attached to the system firmly. Do not warp or twist the module during assemblywork.
2. Protect the module from physical shock or any force. In addition to damage, this may cause improper operation or damage to the module and back-light unit.
3. Note that polarizer is very fragile and could be easily damaged. Do not press or scratch the surface.
4. Do not allow drops of water or chemicals to remain on the display surface. If you have the droplets for a long time, staining and discoloration may occur.
5. If the surface of the polarizer is dirty, clean it using some absorbent cotton or soft cloth.
6. The desirable cleaners are water, IPA (Isopropyl Alcohol) or Hexane. Do not use ketene type materials (ex. Acetone), Ethyl alcohol, Toluene, Ethyl acid or Methyl chloride. It might permanent damage to the polarizer due to chemical reaction.
7. If the liquid crystal material leaks from the panel, it should be kept away from the eyes or mouth. In case of contact with hands, legs, or clothes, it must be washed away thoroughly with soap.
8. Protect the module from static; it may cause damage to the CMOSICs.
9. Use fingerstalls with soft gloves in order to keep display clean during the incoming inspection and assembly process.
10. Do not disassemble the module.
11. Protection film for polarizer on the module shall be slowly peeled off just before use so that the electrostatic charge can be minimized.
12. Pins of I/F connector shall not be touched directly with bare hands.
13. Do not connect, disconnect the module in the "Power ON" condition.
14. Power supply should always be turned on/off by the item Power On Sequence & Power Off Sequence.

7.2 Storage and Transportation

1. Do not leave the panel in high temperature, and high humidity for a long time. It is highly recommended to store the module with temperature from 0 to 35 °C and relative humidity of less than 70%
2. Do not store the TFT-LCD module in direct sunlight.
3. The module shall be stored in a dark place. When storing the modules for a long time, be sure to adopt effective measures for protecting the modules from strong ultraviolet radiation, sunlight, or fluorescent light.
4. It is recommended that the modules should be stored under a condition where no condensation is allowed. Formation of dewdrops may cause an abnormal operation or a failure of the module. In particular, the greatest possible care should be taken to prevent any module from being operated where condensation has occurred inside.
5. This panel has its circuitry FPC on the bottom side and should be handled carefully in order not to be stressed.