



Preamplifier Circuit for IR Remote Control



22906

DESIGN SUPPORT TOOLS

[click logo to get started](#)



FEATURES

- Narrow bandpassfilter for all common carrier frequencies
- High immunity against DC light
- Intelligent AGC to suppress disturbance from fluorescent lamps and CRTs
- Low power consumption
- Wide supply voltage range
- High immunity against ripple on the supply voltage
- Output active low
- IC manufactured in CMOS technology
- Small QFN package with 2 mm width
- Material categorization: for definitions of compliance please see www.vishay.com/doc?99912

RoHS
COMPLIANT
HALOGEN
FREE
GREEN
(5-2008)

DESCRIPTION

The VSOP584.. is designed for use in an IR receiver application together with a photo pin diode. It is a sophisticated receiver concept that is very sensitive to data signals and compatible with the most common data formats for IR remote control. On the other hand it is immune to DC current caused by DC light sources such as tungsten bulbs. The disturbance signal of fluorescent lamps is suppressed; there are no unwanted pulses at the output.

PARTS TABLE		RECOMMENDED FOR LONG BURST CODES (AGC4)
AGC		
Carrier frequency	36 kHz	VSOP58436 (1)(2)(3)
	38 kHz	VSOP58438 (4)(5)(6)
Package		VSOP
Pinning		1, 4, 5 = N.C., 2 = V _S , 3 = OUT, 6, 8 = GND, 7 = IN
Dimensions (mm)		2.0 W x 2.0 H x 0.76 D
Mounting		SMD
Application		Remote control
Best remote control code		(1) RC-5 (2) RC-6 (3) Panasonic (4) NEC (5) Sharp (6) r-map

BLOCK DIAGRAM (Simplified)

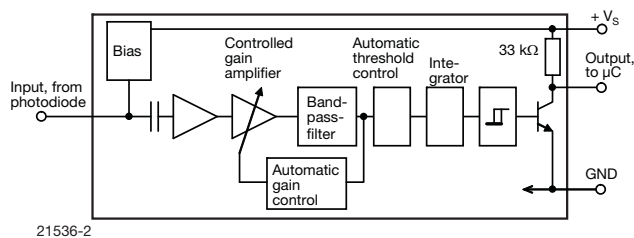

21536-2

APPLICATION CIRCUIT

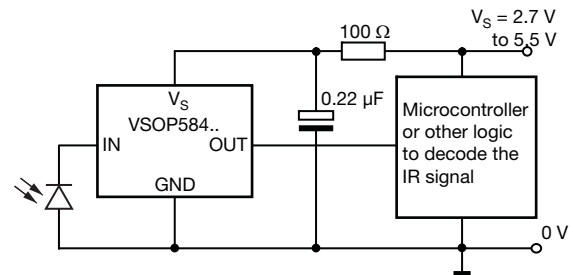

The RC filter is optional to improve the EOS robustness and the immunity to supply voltage ripple. We recommend to keep the distance between the photodiode and the input of the VSOP584.. as short as possible.

21537-5

Vishay recommends using a photodiode with at least 2.3 mm² area. The connection between the photodiode and pin 7 should be kept as short as possible and carefully shielded to prevent noise coupling.



ABSOLUTE MAXIMUM RATINGS (T _{amb} = 25 °C, unless otherwise specified)				
PARAMETER	TEST CONDITION	SYMBOL	VALUE	UNIT
Supply voltage	Pin 2	V _S	-0.3 to +6	V
Supply current	Pin 2	I _S	5	mA
Output voltage	Pin 3	V _O	-0.3 to (V _S + 0.3)	V
Output sink current	Pin 3	I _O	5	mA
Power dissipation	T _{amb} ≤ 85 °C	P _{tot}	10	mW
Operating temperature range		T _{amb}	-25 to +85	°C
Storage temperature range		T _{stg}	-25 to +85	°C
ESD stress, HBM	Pin 2, pin 3, MIL-STD-883C	V _{ESD}	2000	V
	Pin 7, MIL-STD-883C	V _{ESD}	500	V
ESD stress, MM	Pin 2, pin 3, MIL-STD-883C	V _{ESD}	200	V
	Pin 7, MIL-STD-883C	V _{ESD}	100	V

Note

- Stresses beyond those listed under “Absolute Maximum Ratings” may cause permanent damage to the device. This is a stress rating only and functional operation of the device at these or any other conditions beyond those indicated in the operational sections of this specification is not implied. Exposure to absolute maximum rating conditions for extended periods may affect the device reliability.

ELECTRICAL CHARACTERISTICS (T _{amb} = -30 °C to +85 °C)						
PARAMETER	TEST CONDITION	SYMBOL	MIN.	TYP.	MAX.	UNIT
Supply voltage		V _S	2.7	-	5.5	V
Supply current (pin 2)	I _{IN} = 0, V _S = 5 V	I _S	0.65	0.85	1.05	mA
Output voltage low (pin 3)	I _{OL} = 2 mA	V _{OL}	-	-	100	mV
Output voltage high (pin 3)	I _{OL} = 0	V _{OH}	V _S - 0.25	-	-	V
Internal pull up resistor (pin 2, pin 3)		R _{PU}	-	33	-	kΩ
Max. input DC current	V _{IN} > 0	I _{IN-DCmax}	400	-	-	μA
Min. signal detection current	I _{IN-DC} = 0, f _C = f _{BPF}	I _{IN-min}	-	700	1000	pA
	I _{IN-DC} = 100 μA, f _C = f _{BPF}	I _{IN-min}	-	5	10	nA
Output pulse width	I _{IN-DC} = 0, f _C = f _{BPF} , I _{IN} = 0.8 nA to 50 μA, testsignal see fig. 1, BER ≤ 2%	t _{po}	t _{pi} - 6/f ₀	t _{pi}	t _{pi} + 6/f ₀	μs
Accuracy of bandpass center frequency	T _{amb} = + 25 °C	f _{BPF}	f ₀ - 4 %	f ₀	f ₀ + 4 %	kHz
Bandwidth of bandpassfilter	-3 dB, f ₀ = 38 kHz	B	-	3.8	-	kHz

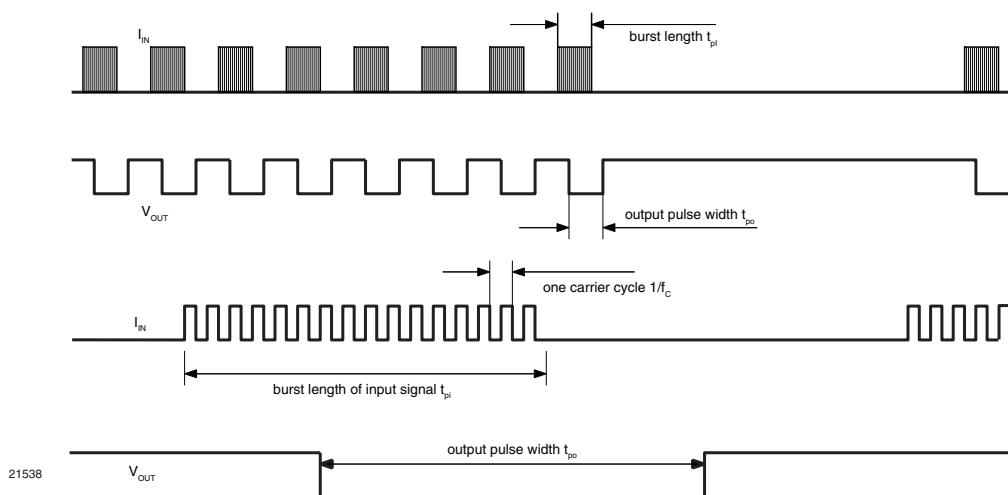

Fig. 1 - Testsignal



TYPICAL CHARACTERISTICS ($T_{amb} = 25\text{ }^{\circ}\text{C}$, $V_S = 3.3\text{ V}$, unless otherwise specified)

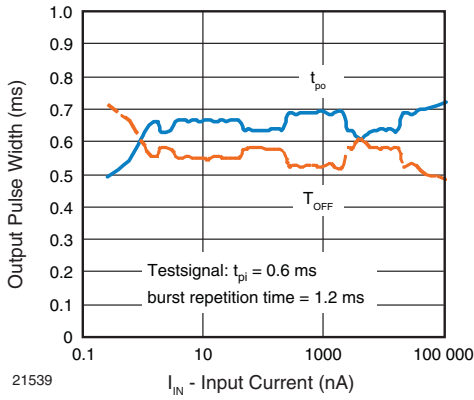

Fig. 2 - Output Pulse Diagram

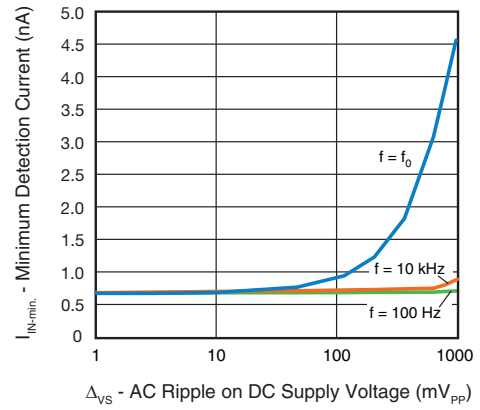

Fig. 5 - Suppression of Ripple on Supply Voltage

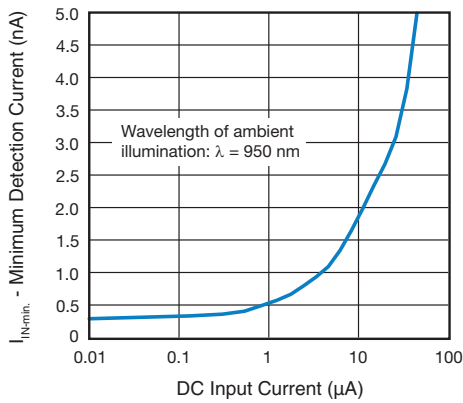

Fig. 3 - Sensitivity vs. DC Input Current

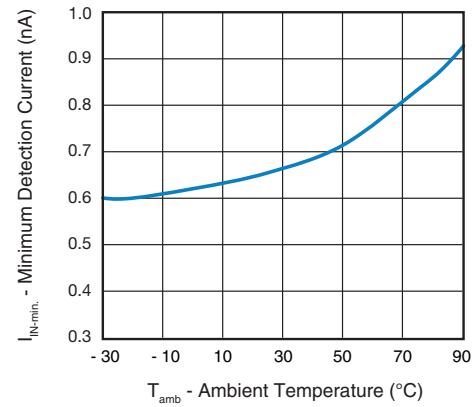

Fig. 6 - Sensitivity vs. Temperature

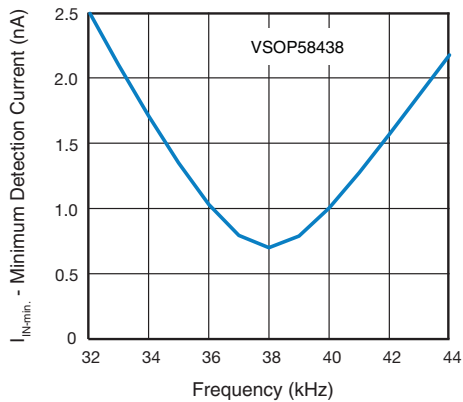

Fig. 4 - Bandpassfilter Characteristic

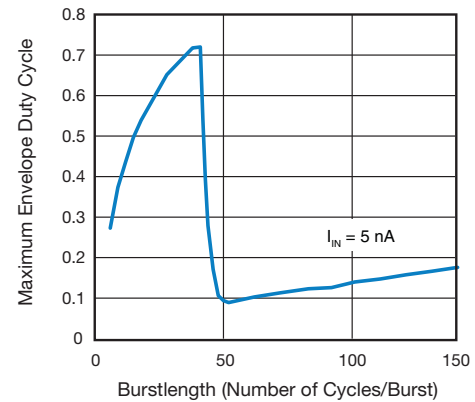
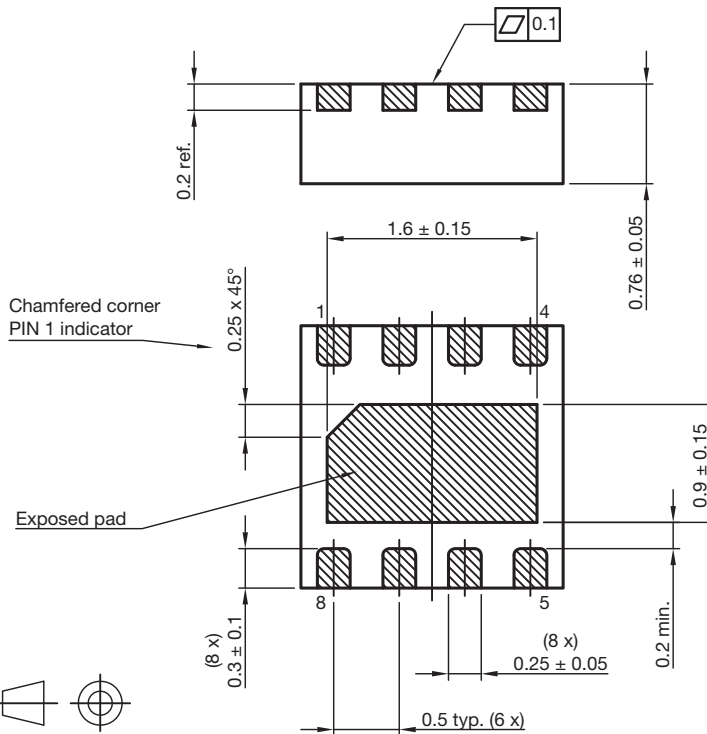
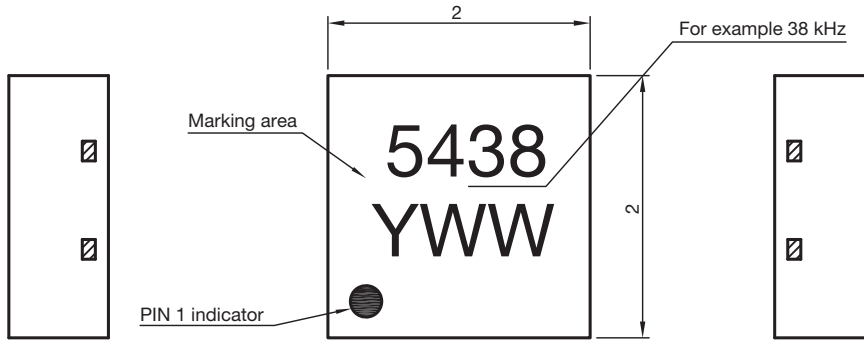

Fig. 7 - Maximum Envelope Duty Cycle



PACKAGE DIMENSIONS in millimeters



1. Coplanarity (0.1 mm) applies to the exposed pad as well as the exposed terminals.
2. Package dimension does not include mold flash, protrusions, burrs or metal smearing.

Pinning:

1. n.c.
2. V_S
3. Out
4. n.c.
5. n.c.
6. GND
7. IN
8. GND

Proposed hole layout from component side (for reference only)

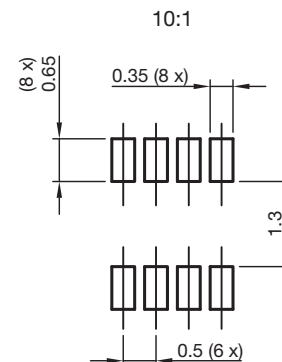

technical drawings according to DIN specifications

Not indicated tolerances ± 0.1

Drawing-No.: 6.550-5314.03-4
Issue: 1; 07.12.15



ASSEMBLY INSTRUCTIONS

Reflow Soldering

- Set the furnace temperatures for pre-heating and heating in accordance with the reflow temperature profile as shown in the diagram. Exercise extreme care to keep the maximum temperature below 260 °C. The temperature shown in the profile means the temperature at the device surface. Since there is a temperature difference between the component and the circuit board, it should be verified that the temperature of the device is accurately being measured
- Handling after reflow should be done only after the work surface has been cooled off

Manual Soldering

- Use a soldering iron of 25 W or less. Adjust the temperature of the soldering iron below 300 °C
- Finish soldering within 3 s
- Handle products only after the temperature has cooled off.

VISHAY LEAD (PB)-FREE REFLOW SOLDER PROFILE

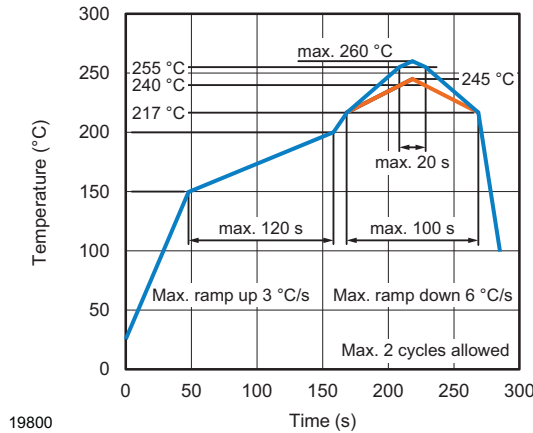



TAPING VERSION VSOP DIMENSIONS in millimeters

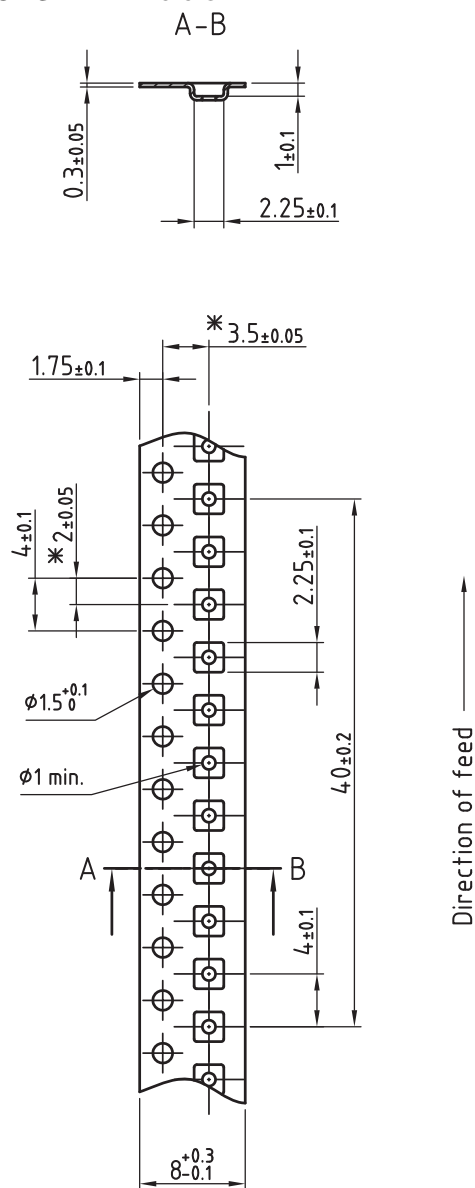

* Measured from centerline of sprocket hole to centerline of pocket



REEL DIMENSIONS in millimeters

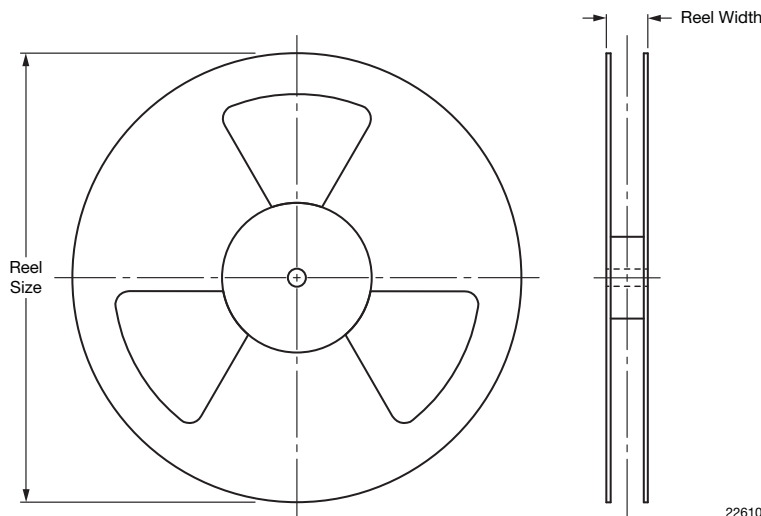

REEL		TRAILER LENGTH (mm)	LEADER LENGTH (mm)	QUANTITY PER REEL
REEL SIZE (inch)	REEL WIDTH (mm)			
7	8.4	160	400	3000

LABEL

Standard bar code labels for finished goods

The standard bar code labels are product labels and used for identification of goods. The finished goods are packed in final packing area. The standard packing units are labeled

with standard bar code labels before transported as finished goods to warehouses. The labels are on each packing unit and contain Vishay Semiconductor GmbH specific data.

VISHAY SEMICONDUCTOR GMBH STANDARD BAR CODE PRODUCT LABEL (finished goods)		
PLAIN WRITTING	ABBREVIATION	LENGTH
Item-description	-	18
Item-number	INO	8
Selection-code	SEL	3
LOT-/serial-number	BATCH	10
Data-code	COD	3 (YWW)
Plant-code	PTC	2
Quantity	QTY	8
Accepted by	ACC	-
Packed by	PCK	-
Mixed code indicator	MIXED CODE	-
Origin	xxxxxxx+	Company logo
LONG BAR CODE TOP	TYPE	LENGTH
Item-number	N	8
Plant-code	N	2
Sequence-number	X	3
Quantity	N	8
Total length	-	21
SHORT BAR CODE BOTTOM	TYPE	LENGTH
Selection-code	X	3
Data-code	N	3
Batch-number	X	10
Filter	-	1
Total length	-	17



ESD PRECAUTION

Proper storage and handling procedures should be followed to prevent ESD damage to the devices especially when they are removed from the antistatic shielding bag. Electrostatic sensitive devices warning labels are on the packaging.

**VISHAY SEMICONDUCTORS STANDARD
BAR CODE LABELS**

The Vishay Semiconductors standard bar code labels are printed at final packing areas. The labels are on each packing unit and contain Vishay Semiconductors specific data.



16962



Disclaimer

ALL PRODUCT, PRODUCT SPECIFICATIONS AND DATA ARE SUBJECT TO CHANGE WITHOUT NOTICE TO IMPROVE RELIABILITY, FUNCTION OR DESIGN OR OTHERWISE.

Vishay Intertechnology, Inc., its affiliates, agents, and employees, and all persons acting on its or their behalf (collectively, "Vishay"), disclaim any and all liability for any errors, inaccuracies or incompleteness contained in any datasheet or in any other disclosure relating to any product.

Vishay makes no warranty, representation or guarantee regarding the suitability of the products for any particular purpose or the continuing production of any product. To the maximum extent permitted by applicable law, Vishay disclaims (i) any and all liability arising out of the application or use of any product, (ii) any and all liability, including without limitation special, consequential or incidental damages, and (iii) any and all implied warranties, including warranties of fitness for particular purpose, non-infringement and merchantability.

Statements regarding the suitability of products for certain types of applications are based on Vishay's knowledge of typical requirements that are often placed on Vishay products in generic applications. Such statements are not binding statements about the suitability of products for a particular application. It is the customer's responsibility to validate that a particular product with the properties described in the product specification is suitable for use in a particular application. Parameters provided in datasheets and / or specifications may vary in different applications and performance may vary over time. All operating parameters, including typical parameters, must be validated for each customer application by the customer's technical experts. Product specifications do not expand or otherwise modify Vishay's terms and conditions of purchase, including but not limited to the warranty expressed therein.

Hyperlinks included in this datasheet may direct users to third-party websites. These links are provided as a convenience and for informational purposes only. Inclusion of these hyperlinks does not constitute an endorsement or an approval by Vishay of any of the products, services or opinions of the corporation, organization or individual associated with the third-party website. Vishay disclaims any and all liability and bears no responsibility for the accuracy, legality or content of the third-party website or for that of subsequent links.

Except as expressly indicated in writing, Vishay products are not designed for use in medical, life-saving, or life-sustaining applications or for any other application in which the failure of the Vishay product could result in personal injury or death. Customers using or selling Vishay products not expressly indicated for use in such applications do so at their own risk. Please contact authorized Vishay personnel to obtain written terms and conditions regarding products designed for such applications.

No license, express or implied, by estoppel or otherwise, to any intellectual property rights is granted by this document or by any conduct of Vishay. Product names and markings noted herein may be trademarks of their respective owners.