

## 10.7 GHz to 12.7 GHz, SATCOM, Microwave Downconverter

### FEATURES

- ▶ X/Ku band to IF downconverter with integrated PLL
- ▶ RF input frequency range: 10.7 GHz to 12.7 GHz
- ▶ Internal LO frequency range: 8.7 GHz to 10.7 GHz
- ▶ Noise figure: 5.2 dB, minimum attenuation, LNA low gain mode
- ▶ Matched, 50  $\Omega$ , single-ended RF input and IF output
- ▶ On-chip temperature sensor
- ▶ On-chip ADC
- ▶ Receiver synthesizer lock detect pin
- ▶ Programmable at 20 MHz via 4-wire SPI interface
- ▶ Receiver standby function
- ▶ 40-lead, 6 mm  $\times$  6 mm LFCSP package

### APPLICATIONS

- ▶ SATCOM user terminals

### FUNCTIONAL BLOCK DIAGRAM

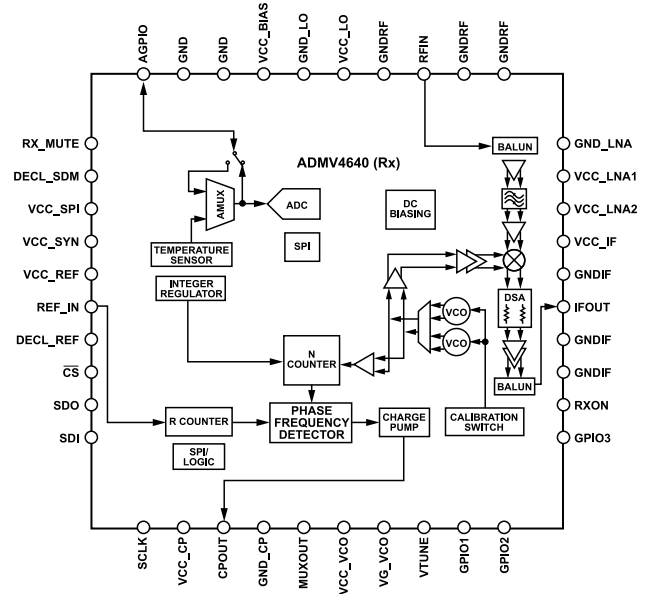

Figure 1.

### GENERAL DESCRIPTION

The ADMV4640 is a microwave downconverter optimized for various satellite communication (SATCOM) user terminals operating in the 10.7 GHz to 12.7 GHz RF range.

The ADMV4640 local oscillator (LO) signal is generated internally via the on-chip Integer N (INT) synthesizer. The internal synthesizer enables LO frequency coverage from 8.7 GHz to 10.7GHz. The input RF signals from 10.7 GHz to 12.7 GHz are downconverted to an output intermediate frequency (IF) of 1.4 GHz to 2.2 GHz. The chip includes filtering to reject the image band of 6.7 GHz to 8.7 GHz. The on-chip low noise amplifier includes a 6 dB step attenuator before the mixer to allow the user to trade off between lower noise figure and higher linearity. In addition, the chip includes a digital step attenuator at the IF output to provide up to 31 dB of gain control range with 1 dB steps to adjust for subsequent cable losses.

The digital serial peripheral interface (SPI) allows easy programming of the device. In addition to the digital SPI control, an analog control pin (RX\_MUTE) quickly powers down all circuits and places the receiver in standby mode for power saving. An analog general-purpose input-output (AGPIO) pin can be used either as an input to be read by the on-chip analog-to-digital converter (ADC) or as an output for internal analog proportional to absolute temperature (PTAT) voltage. There are also three digital GPIO pins to output logic levels to control external devices using the SPI.

The ADMV4640 downconverter comes in a compact, thermally enhanced, 6 mm  $\times$  6 mm, 40-lead, lead frame chip scale package (LFCSP). The ADMV4640 operates over the  $-40^{\circ}\text{C}$  to  $+85^{\circ}\text{C}$  case temperature range.

**TABLE OF CONTENTS**

Features.....	1	Phase Frequency Detector (PFD) and CP.....	21
Applications.....	1	Loop Filter and CP Current.....	21
Functional Block Diagram.....	1	On-Chip MUXOUT Pin.....	22
General Description.....	1	Analog MUX Block, AGPIO Pin, and ADC.....	22
Specifications.....	3	GPIOx Pins.....	22
Absolute Maximum Ratings.....	5	Digital Lock Detect and MUTE_IF_UNLOCKED Bit.....	22
Thermal Resistance.....	5	Signal Chain Bias Register, Mask Register, RX_MUTE Pin, and RXON Pin.....	22
ESD Caution.....	5	SPI Configuration.....	23
Pin Configuration and Function Descriptions.....	6	VCO Autocalibration and Automatic Level Control.....	23
Typical Performance Characteristics.....	8	Double Buffered Registers.....	23
Minimum Attenuation Performance: DSA (Register 0x300) = 31.....	8	Initialization Registers.....	23
Maximum Attenuation Performance: DSA (Register 0x300) = 0.....	17	Register Summary.....	25
Spurious Performance.....	20	Register Details.....	27
Theory of Operation.....	21	SPI Configuration Register.....	27
Reference Input Stage.....	21	Outline Dimensions.....	41
Reference Doubler, R Counter, and Reference Divide By 2.....	21	Ordering Guide.....	41
INT Mode and N Counter .....	21	Evaluation Boards.....	41

**REVISION HISTORY****7/2022—Revision A: Initial Version**

## SPECIFICATIONS

$T_A = 25^\circ\text{C}$ ,  $IF = 2\text{ GHz}$ ,  $VCC = VCC\_SPI = VCC\_SYN = VCC\_REF = VCC\_CP = VCC\_VCO = VCC\_IF = VCC\_LNA2 = VCC\_LNA1 = VCC\_LO = VCC\_BIAS = 3.3\text{ V}$ , digital signal attenuation (DSA) Register 0x300 = 31, clock reference input power = 3 dBm, upper sideband selected, unless otherwise noted. VCC refers to the voltage of all VCC\_xxx pins.

Table 1.

Parameter	Test Conditions/Comments	Min	Typ	Max	Unit
RF INPUT FREQUENCY RANGE		10.7		12.7	GHz
LO FREQUENCY RANGE		8.7		10.7	GHz
LO Lock Time				370	$\mu\text{s}$
LO REFERENCE FREQUENCY			25		MHz
SPI FREQUENCY			20		MHz
CLOCK REFERENCE INPUT POWER		0		5	dBm
LO PHASE NOISE PERFORMANCE					
1 kHz Offset from Carrier			-85		dBc/Hz
10 kHz Offset from Carrier			-90		dBc/Hz
100 kHz Offset from Carrier			-95		dBc/Hz
1 MHz Offset from Carrier			-124		dBc/Hz
10 MHz Offset from Carrier			-138		dBc/Hz
100 MHz Offset from Carrier	As measured at the IF output		-142		dBc/Hz
Integrated Single Sideband Phase Noise Performance	1 kHz to 125 MHz		-40		dBc/Hz
IF OUTPUT FREQUENCY RANGE		1.4		2.2	GHz
IF Channel Bandwidth			$\pm 125$		MHz
IF DOWNCONVERTER PERFORMANCE					
Maximum Conversion Gain	Minimum attenuation, low noise amplifier (LNA) high gain mode	24	27	30	dB
Minimum Conversion Gain	Minimum attenuation, LNA low gain mode	18	21		dB
Gain Control Range			31		dB
Gain Flatness	Over 230 MHz bandwidth	-0.36		+0.36	dB/230 MHz <sup>1</sup>
Noise Figure	Minimum attenuation, LNA high gain mode		4.2	6.2	dB
	Minimum attenuation, LNA low gain mode		5.2	7.4	dB
Input Third-Order Intercept (IP3)	Input power ( $P_{IN}$ ) = -33 dBm per tone, minimum attenuation, LNA high gain mode	-7.9	-6		dBm
	$P_{IN}$ = -33 dBm per tone, minimum attenuation, LNA low gain mode	-4.7	-1		dBm
Input 1 dB Compression Point (P1dB)	Minimum attenuation, LNA high gain mode	-18	-15		dBm
	Minimum attenuation, LNA low gain mode	-13	-11		dBm
LO to RF Feedthrough			-50	-30	dBm
Image Rejection		10.5			
	RF = 10.7 GHz to 12.45 GHz	17	30		dBc
	RF = 12.45 GHz to 12.7 GHz	10.5	17		dB
ADC PERFORMANCE					
ADC Bits Resolution			8		Bits
ADC Sampling Rate			100		kHz
POWER INTERFACE					
Power Supply Voltage ( $VCC\_xxx$ ) <sup>2</sup>		3.15	3.3	3.45	V
VCC_SPI			2		mA
VCC_SYN Supply Current			56		mA

## SPECIFICATIONS

Table 1.

Parameter	Test Conditions/Comments	Min	Typ	Max	Unit
VCC_REF Supply Current			1		mA
VCC_CP Supply Current			16		mA
VCC_VCO Supply Current			80		mA
VCC_IF Supply Current			68		mA
VCC_LNA2 Supply Current			42		mA
VCC_LNA1 Supply Current			30		mA
VCC_LO Supply Current			48		mA
VCC_BIAS Supply Current			15		mA
VCC Total Current			358		mA
Total Power			1.35	1.5	W
Unmute Time				15	$\mu$
Mute Time				15	$\mu$

<sup>1</sup> dB/230 MHz is gain flatness over 230 MHz bandwidth.

<sup>2</sup> VCC\_xx = VCC\_SPI = VCC\_SYN = VCC\_REF = VCC\_CP = VCC\_VCO = VCC\_IF = VCC\_LNA2 = VCC\_LNA1 = VCC\_LO = VCC\_BIAS = 3.3 V.

## ABSOLUTE MAXIMUM RATINGS

Table 2.

Parameter	Rating
Supply Voltage VCC_SPI, VCC_SYN, VCC_REF, VCC_CP, VCC_VCO, VCC_IF, VCC_LNA2, VCC_LNA1, VCC_LO, VCC_BIAS	4.3 V
RF Input Power	0 dBm
Reference Clock Input Power	12 dBm
Maximum Junction Temperature	125°C
Moisture Sensitivity Level (MSL) <sup>1</sup>	3
Peak Reflow Temperature	260°C
Operating Case Temperature Range	-40°C to +85°C
Storage Temperature Range	-55°C to +125°C
ESD Sensitivity	
Human Body Model (HBM)	2000 V
Field Induced Charged Device Model (FICDM)	250 V

<sup>1</sup> Based on IPC/JEDEC J-STD-20 MSL classifications.

Stresses at or above those listed under Absolute Maximum Ratings may cause permanent damage to the product. This is a stress rating only; functional operation of the product at these or any other conditions above those indicated in the operational section of this specification is not implied. Operation beyond the maximum operating conditions for extended periods may affect product reliability.

## THERMAL RESISTANCE

Thermal performance is directly linked to printed circuit board (PCB) design and operating environment. Careful attention to PCB thermal design is required.

$\theta_{JA}$  is the junction to ambient (or die to ambient) thermal resistance measured in a one cubic foot, sealed enclosure, and  $\theta_{JC}$  is the junction to case (or die to package) thermal resistance.

Table 3. Thermal Resistance

Package Type	$\theta_{JA}$ <sup>1</sup>	$\theta_{JC}$ <sup>1,2</sup>	Unit
CP-40-7 <sup>1</sup>	30.7	1.1	°C/W

<sup>1</sup> The thermal impedance simulated values are based on a JEDEC 2S2P test board with 6 mm × 6 mm thermal vias. Refer to JEDEC standard JESD51-2 for additional information.

<sup>2</sup> The cold plate of the  $\theta_{JC}$  bottom is attached to the bottom side of the PCB using a 100  $\mu$ m thermal interface material (TIM) (3.56 W/mK).

## ESD CAUTION



**ESD (electrostatic discharge) sensitive device.** Charged devices and circuit boards can discharge without detection. Although this product features patented or proprietary protection circuitry, damage may occur on devices subjected to high energy ESD. Therefore, proper ESD precautions should be taken to avoid performance degradation or loss of functionality.

## PIN CONFIGURATION AND FUNCTION DESCRIPTIONS

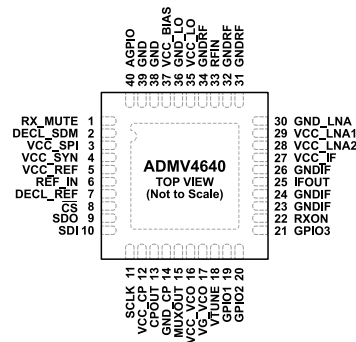

NOTES  
1. THE EXPOSED PAD MUST BE CONNECTED TO GROUND. 

Figure 2. Pin Configuration

Table 4. Pin Function Descriptions

Pin No.	Mnemonic	Description
1	RX_MUTE	Receiver Chip Disable Pin. Drive the RX_MUTE pin to a logic low level in normal operation. Pull the RX_MUTE pin to a logic high level to disable the receiver.
2	DECL_SDM	Internal Low Drop Out (LDO) Decoupling Pin. Decouple the DECL_SDM pin with 100 pF and 1000 pF as close as possible to the pin.
3	VCC_SPI	3.3 V Power Supply Connections for SPI Control. Decouple the VCC_SPI pin with 100 pF and 1000 pF as close as possible to the pin.
4	VCC_SYN	3.3 V Power Supply Connections for the Synthesizer. Decouple the VCC_SYN pin with 100 pF and 1000 pF as close as possible to the pin.
5	VCC_REF	3.3 V Power Supply Connections for Reference. Decouple the VCC_REF pin with 100 pF and 1000 pF as close as possible to the pin.
6	REF_IN	Reference Frequency Input.
7	DECL_REF	Reference Decoupling Pin. Decouple the DECL_REF pin with 100 pF and 1000 pF as close as possible to the pin.
8	$\overline{CS}$	Chip Select Pin.
9	SDO	Serial Data Output. The SDO pin provides an SPI readback capability.
10	SDI	Serial Data Input. Serial data applied to the SDI pin is loaded into the SPI register upon completion of a write command. The first MSB is a control bit that determines whether data is written to the register (logic high) or read from the serial data output pin (logic low).
11	SCLK	Serial Clock. This pin is the clock input for the SPI interface.
12	VCC_CP	3.3 V Power Supply Connections for the Charge Pump (CP). Decouple the VCC_CP pin with 10 pF and 1000 pF as close as possible to the pin.
13	CPOUT	CP Output Pin.
14, 23, 24, 26, 30, 31, 32, 34, 36, 38, 39	GND_CP, GNDIF, GND_LNA, GNDRF, GNDLO, GND	Grounds. Connect these pins to a low impedance ground plane.
15	MUXOUT	Multiplex Output. See the <a href="#">MUXOUT Select Register</a> section (Register 0x24E).
16	VCC_VCO	3.3 V Power Supply Connections for the Voltage Controlled Oscillator (VCO). Apply the low noise source power supply to the VCC_VCO pin and decouple the VCC_VCO pin with 10 pF and 1000 pF as close as possible to the pin.
17	VG_VCO	VCO Internal Node for DC Decoupling. Decouple the VG_VCO pin with 0.1 $\mu$ F as close as possible to the pin.
18	VTUNE	VCO Tuning Voltage. This pin is driven by the output of the loop filter.
19	GPIO1	General-Purpose Input/Output. This pin provides an additional digital control line and can be configured to be an input or output, high (3.3 V) or low logic level (0 V).
20	GPIO2	General-Purpose Input/Output. This pin provides an additional digital control line and can be configured to be an input or output, high (3.3 V) or low logic level (0 V).

## PIN CONFIGURATION AND FUNCTION DESCRIPTIONS

Table 4. Pin Function Descriptions

Pin No.	Mnemonic	Description
21	GPI03	General-Purpose Input/Output. This pin provides an additional digital control line and can be configured to be an input or output, high (3.3 V) or low logic level (0 V).
22	RXON	Power-Up Pin for Receiver Chip. Pull the RXON pin to a logic high level in normal operation. Drive the RXON pin to a logic low level to disable the chip.
25	IFOUT	Intermediate Frequency (IF) Output.
27	VCC_IF	3.3 V Power Supply Connections for IF Section. Decouple the VCC_IF pin with 10 pF and 1000 pF as close as possible to the pin.
28	VCC_LNA2	3.3 V Power Supply Connections for the Second Stage Low Noise Amplifier (LNA2). Decouple the VCC_LNA2 pin with 10 pF and 1000 pF as close as possible to the pin.
29	VCC_LNA1	3.3 V Power Supply Connections for First Stage Low Noise Amplifier (LNA1). Decouple the VCC_LNA2 pin with 10 pF and 1000 pF as close as possible to the pin.
33	RFIN	RF Inputs. This pin must be ac-coupled.
35	VCC_LO	3.3 V Power Supply Connections for LO Amplifiers. Decouple the VCC_LO pin with 10 pF and 1000 pF as close as possible to the pin.
37	VCC_BIAS	3.3 V Power Supply Connections for Bias Current Generator. Decouple the VCC_BIAS pin with 10 pF and 1000 pF as close as possible to the pin.
40	AGPIO	Bidirectional Analog General-Purpose Input/Output. This pin can be configured to be the input or to be the output of the internal analog-to-digital converter (ADC). See the <a href="#">AGPIO Control Register</a> section (Register 0x301).
	EPAD	Exposed Pad. The exposed pad must be connected to ground.

TYPICAL PERFORMANCE CHARACTERISTICS

MINIMUM ATTENUATION PERFORMANCE: DSA (REGISTER 0X300) = 31

T<sub>A</sub> = 25°C, IF = 2 GHz, VCC = 3.3 V, clock reference input power = 3 dBm, upper sideband selected, unless otherwise noted.

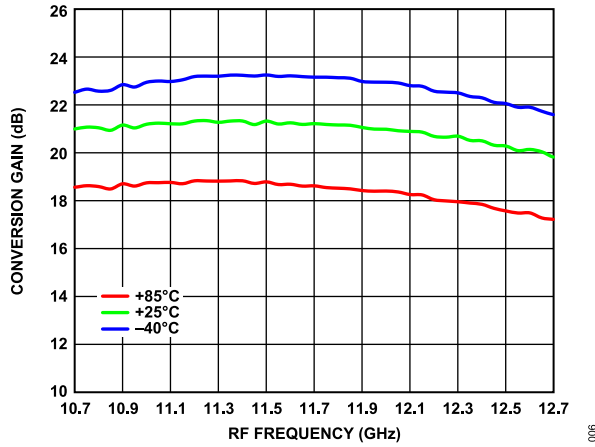

Figure 3. Conversion Gain vs. RF Frequency over Temperature, LNA Low Gain Mode

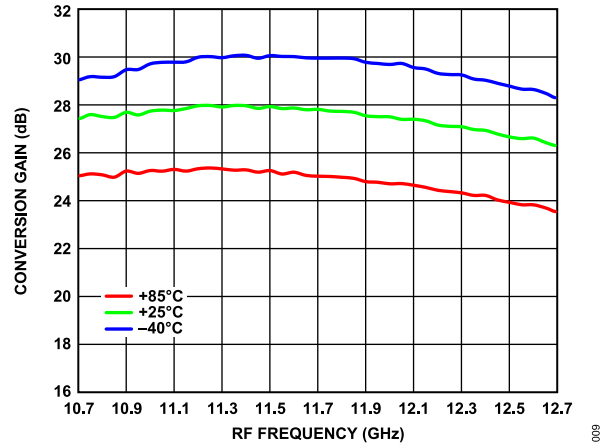

Figure 6. Conversion Gain vs. RF Frequency over Temperature, LNA High Gain Mode

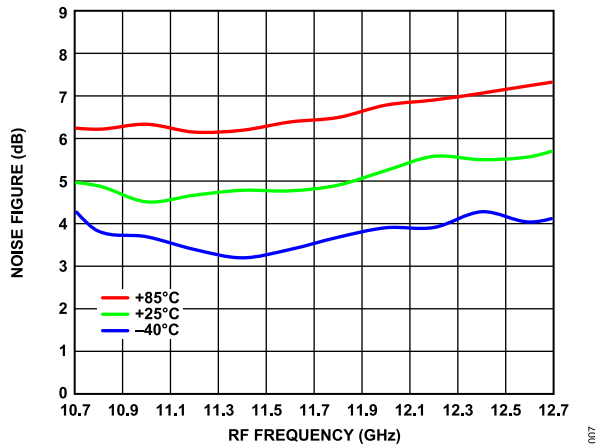

Figure 4. Noise Figure vs. RF Frequency over Temperature, LNA Low Gain Mode

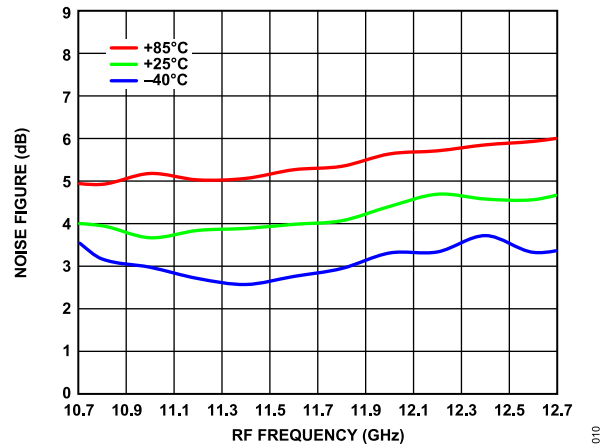

Figure 7. Noise Figure vs. RF Frequency over Temperature, LNA High Gain Mode

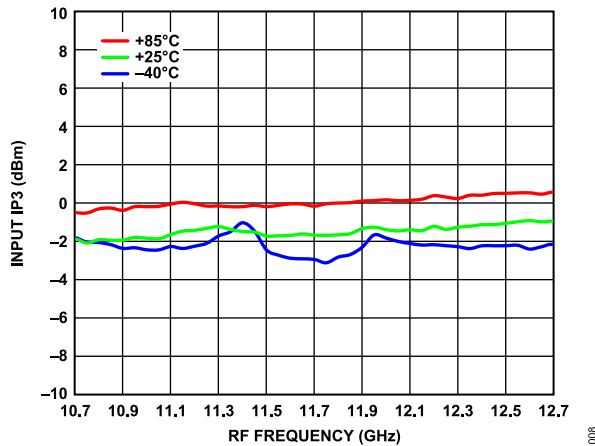

Figure 5. Input IP3 vs. RF Frequency over Temperature, LNA Low Gain Mode

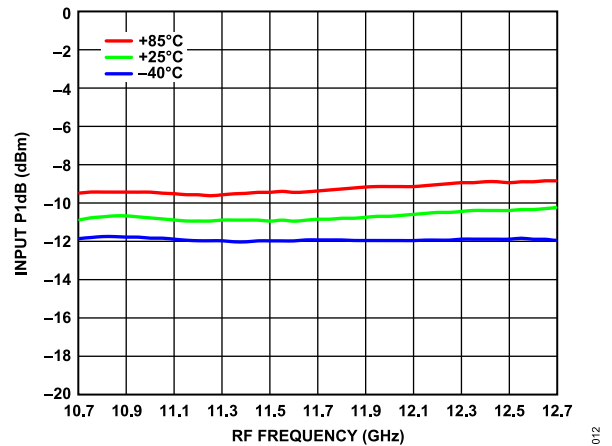

Figure 8. Input P1dB vs. RF Frequency over Temperature, LNA Low Gain Mode



TYPICAL PERFORMANCE CHARACTERISTICS

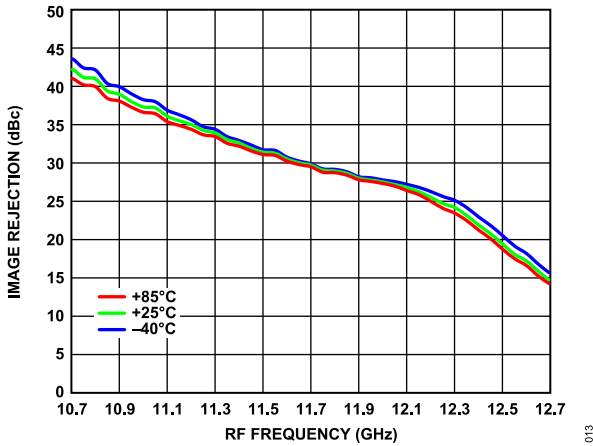

Figure 9. Image Rejection vs. RF Frequency over Temperature, LNA Low Gain Mode

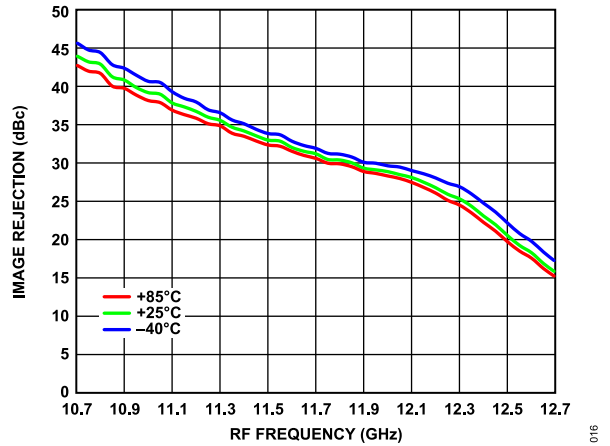

Figure 12. Image Rejection vs. RF Frequency over Temperature, LNA High Gain Mode

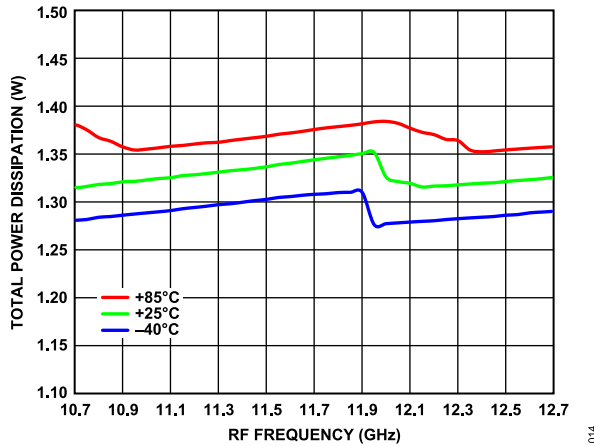

Figure 10. Total Power Dissipation vs. RF Frequency over Temperature, LNA Low Gain Mode

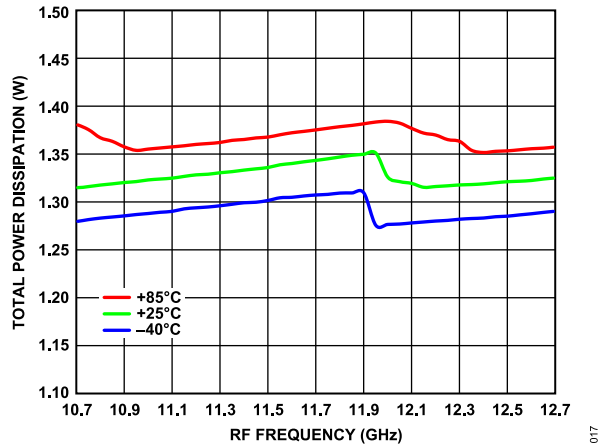

Figure 13. Total Power Dissipation vs. RF Frequency over Temperature, LNA High Gain Mode

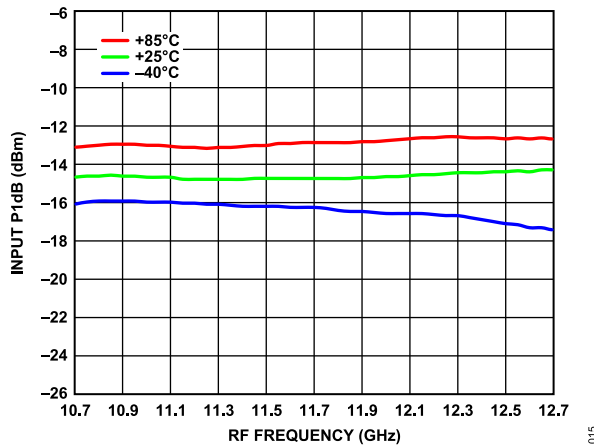

Figure 11. Input P1dB vs. RF Frequency over Temperature, LNA High Gain Mode

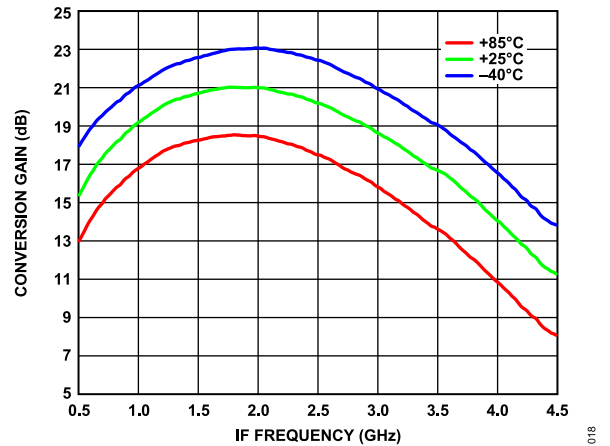

Figure 14. Conversion Gain vs. IF Frequency over Temperature, LO Frequency = 10 GHz, LNA Low Gain Mode

TYPICAL PERFORMANCE CHARACTERISTICS

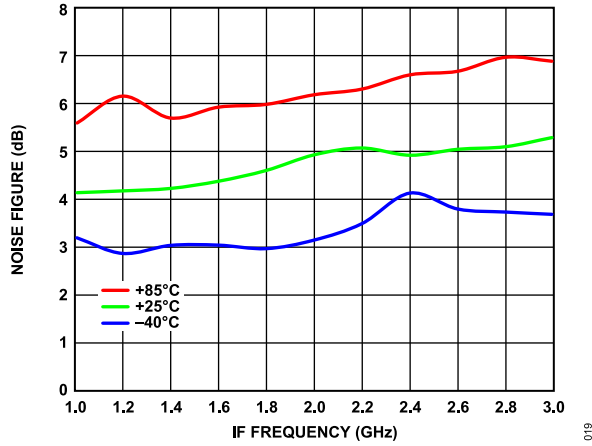

Figure 15. Noise Figure vs. IF Frequency over Temperature, LO Frequency = 10 GHz, LNA Low Gain Mode

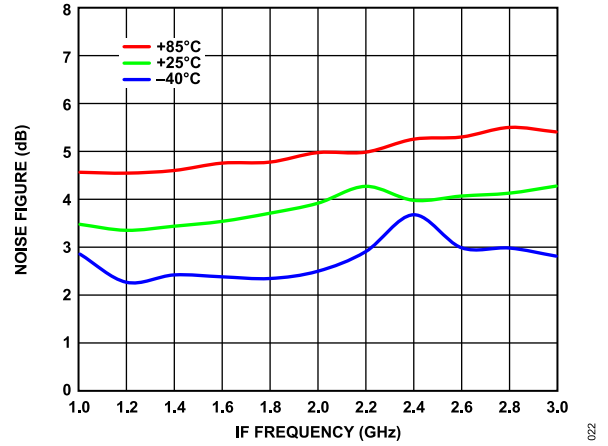

Figure 18. Noise Figure vs. IF Frequency over Temperature, LO Frequency = 10 GHz, LNA High Gain Mode

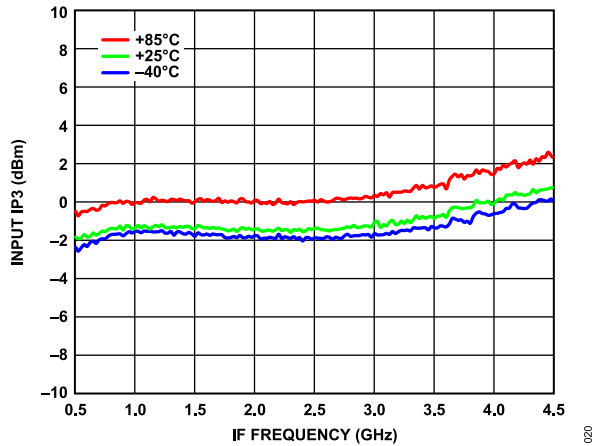

Figure 16. Input IP3 vs. IF Frequency over Temperature, LO Frequency = 10 GHz, LNA Low Gain Mode

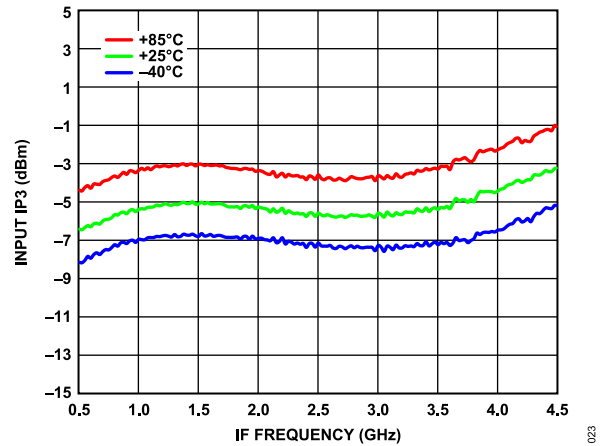

Figure 19. Input IP3 vs. IF Frequency over Temperature, LO Frequency = 10 GHz, LNA High Gain Mode

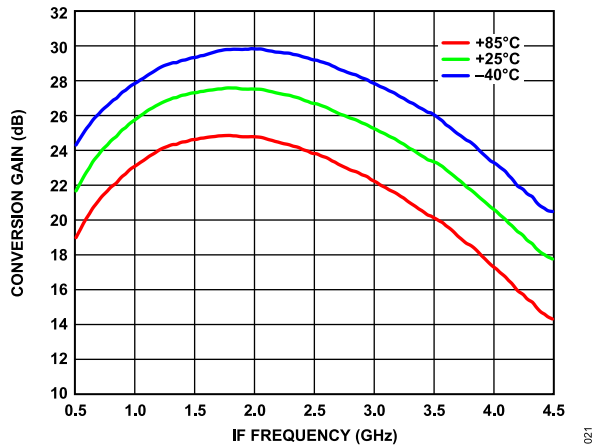

Figure 17. Conversion Gain vs. IF Frequency over Temperature, LO Frequency = 10 GHz, LNA High Gain Mode

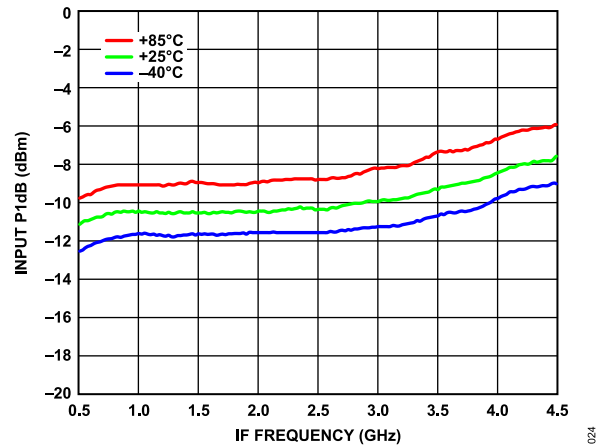

Figure 20. Input P1dB vs. IF Frequency over Temperature, LO Frequency = 10 GHz, LNA Low Gain Mode

TYPICAL PERFORMANCE CHARACTERISTICS

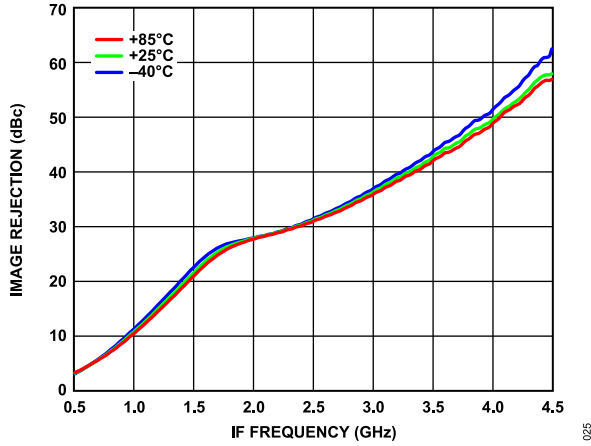

Figure 21. Image Rejection vs. IF Frequency over Temperature, LO Frequency = 10 GHz, LNA Low Gain Mode

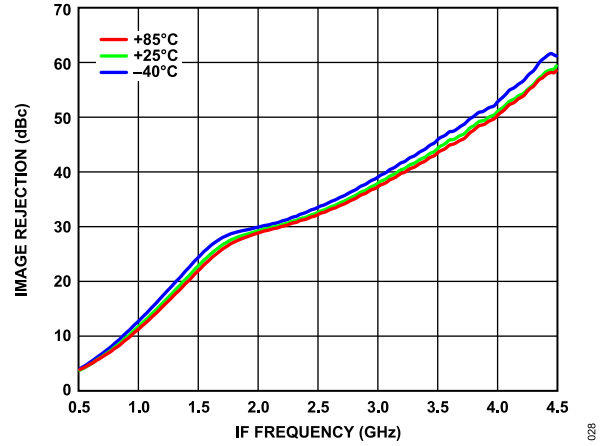

Figure 24. Image Rejection vs. IF Frequency over Temperature, LO Frequency = 10 GHz, LNA High Gain Mode

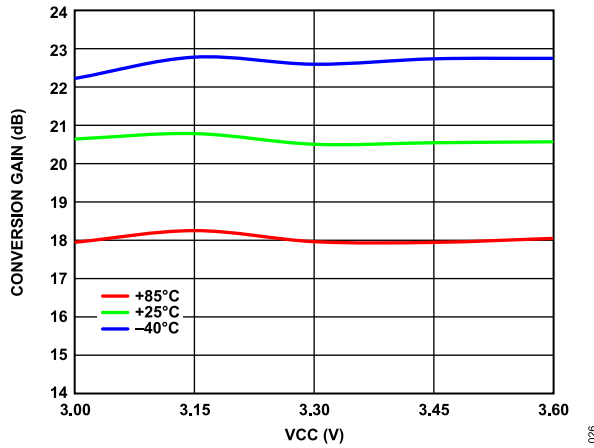

Figure 22. Conversion Gain vs. VCC over Temperature, LO Frequency = 10 GHz, LNA Low Gain Mode

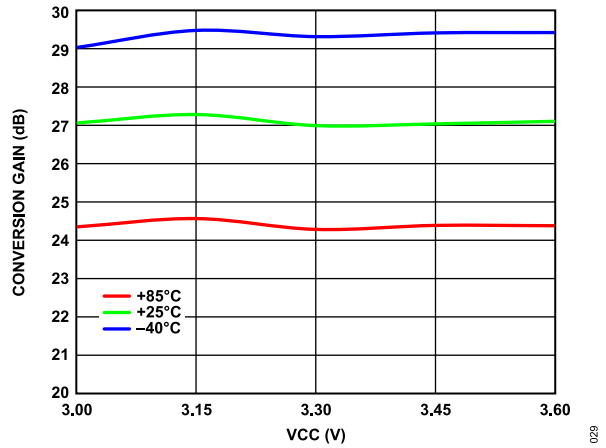

Figure 25. Conversion Gain vs. VCC over Temperature, LO Frequency = 10 GHz, LNA High Gain Mode

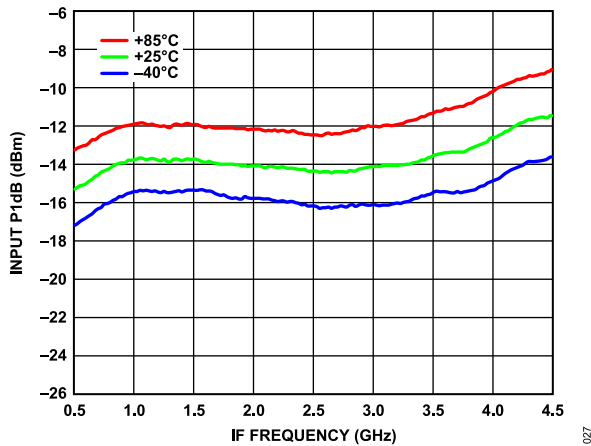

Figure 23. Input P1dB vs. IF Frequency over Temperature, LO Frequency = 10 GHz, LNA High Gain Mode

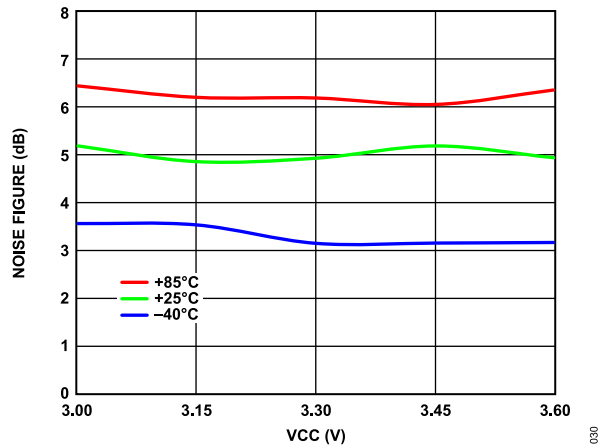

Figure 26. Noise Figure vs. VCC over Temperature, LO Frequency = 10 GHz, LNA Low Gain Mode

TYPICAL PERFORMANCE CHARACTERISTICS

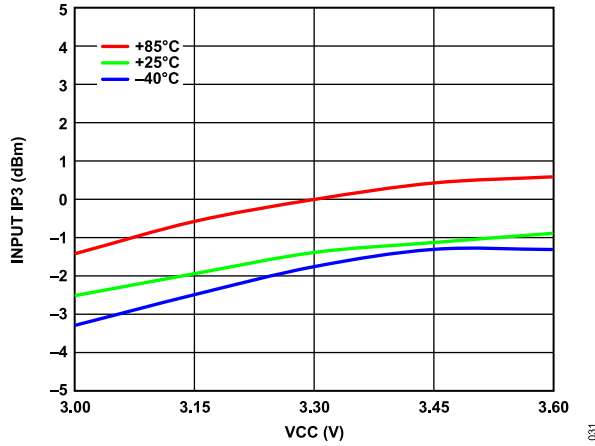

Figure 27. Input IP3 vs. VCC over Temperature, LO Frequency = 10 GHz, LNA Low Gain Mode

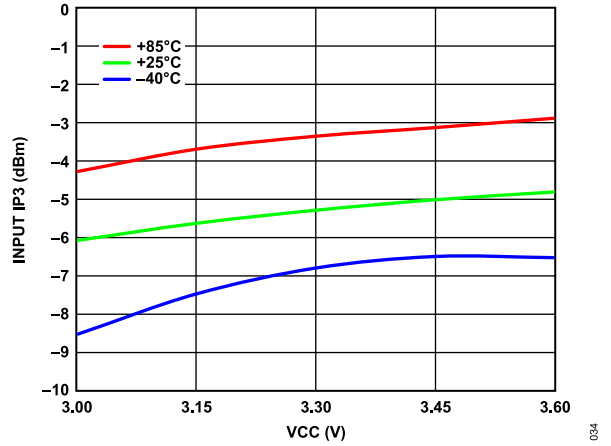

Figure 30. Input IP3 vs. VCC over Temperature, LO Frequency = 10 GHz, LNA High Gain Mode

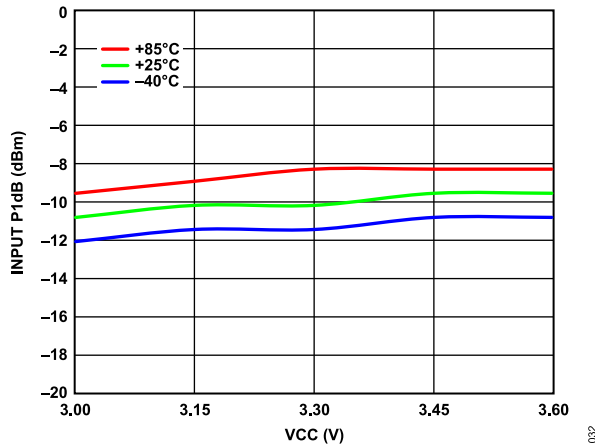

Figure 28. Input P1dB vs. VCC over Temperature, LO Frequency = 10 GHz, LNA Low Gain Mode

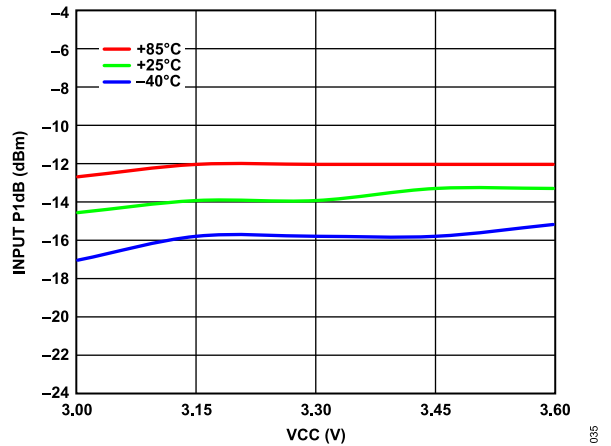

Figure 31. Input P1dB vs. VCC over Temperature, LO Frequency = 10 GHz, LNA High Gain Mode

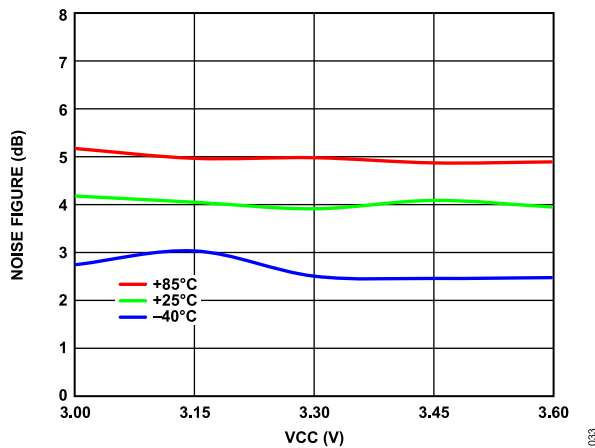

Figure 29. Noise Figure vs. VCC over Temperature, LO Frequency = 10 GHz, LNA High Gain Mode

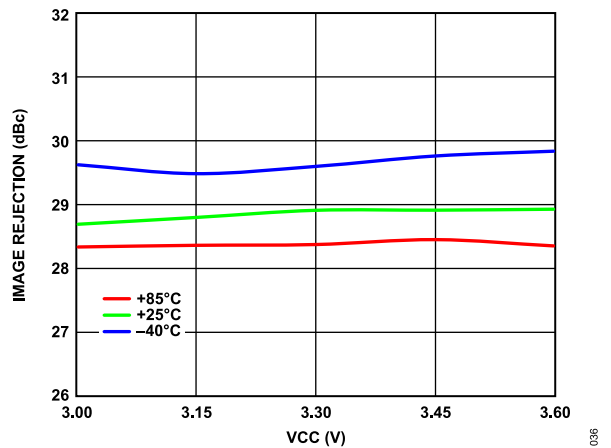

Figure 32. Image Rejection vs. VCC over Temperature, LO Frequency = 10 GHz, LNA Low Gain Mode

TYPICAL PERFORMANCE CHARACTERISTICS

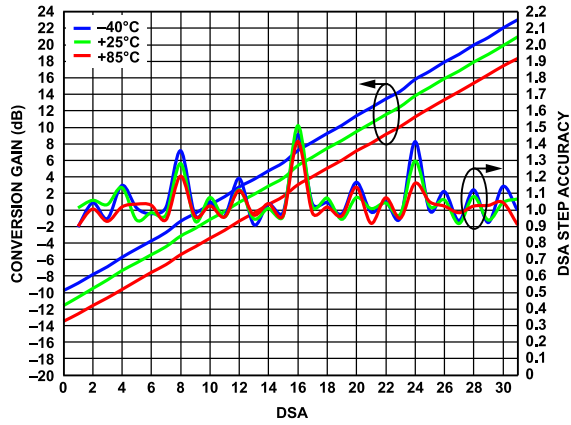

Figure 33. Conversion Gain and DSA Step Accuracy vs. DSA over Temperature, LO Frequency = 10 GHz, LNA Low Gain Mode

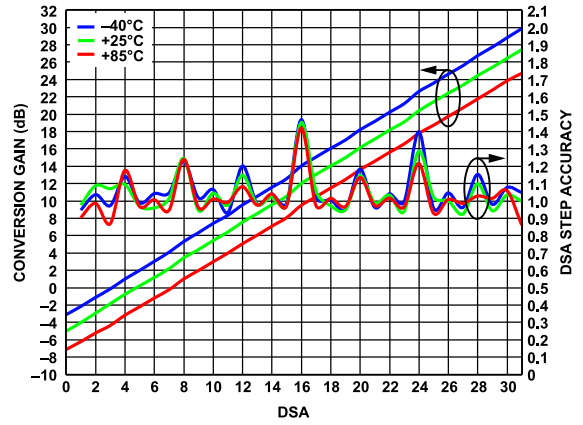

Figure 36. Conversion Gain and DSA Step Accuracy vs. DSA over Temperature, LO Frequency = 10 GHz, LNA High Gain Mode

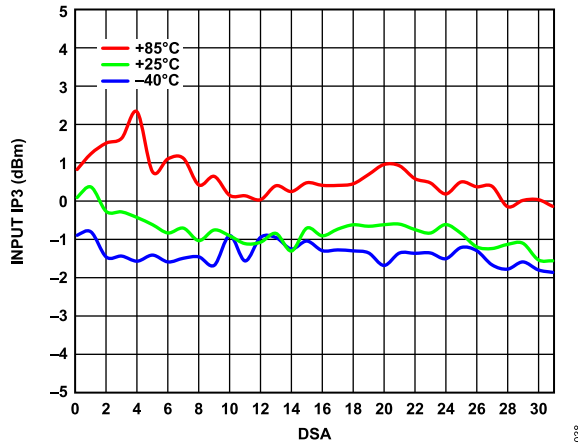

Figure 34. Input IP3 vs. DSA over Temperature, LO Frequency = 10 GHz, LNA Low Gain Mode

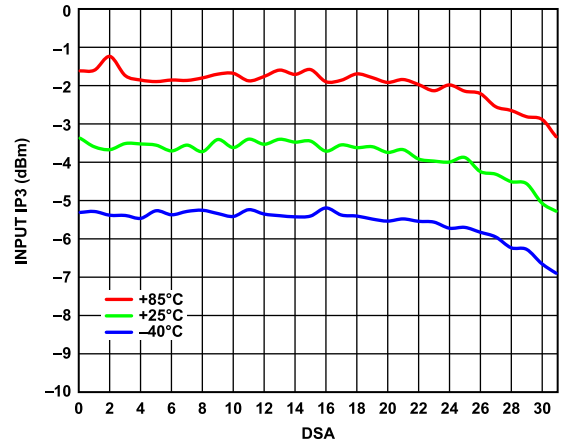

Figure 37. Input IP3 vs. DSA over Temperature, LO Frequency = 10 GHz, LNA High Gain Mode

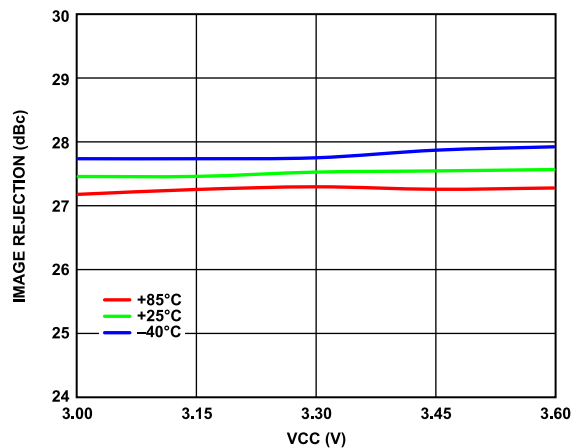

Figure 35. Image Rejection vs. VCC over Temperature, LO Frequency = 10 GHz, LNA High Gain Mode

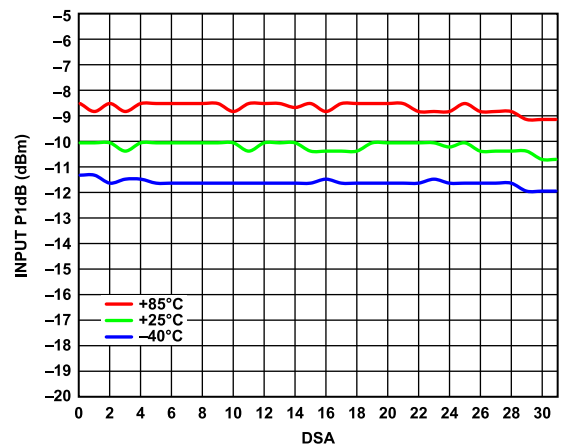

Figure 38. Input P1dB vs. DSA over Temperature, LO Frequency = 10 GHz, LNA Low Gain Mode

TYPICAL PERFORMANCE CHARACTERISTICS

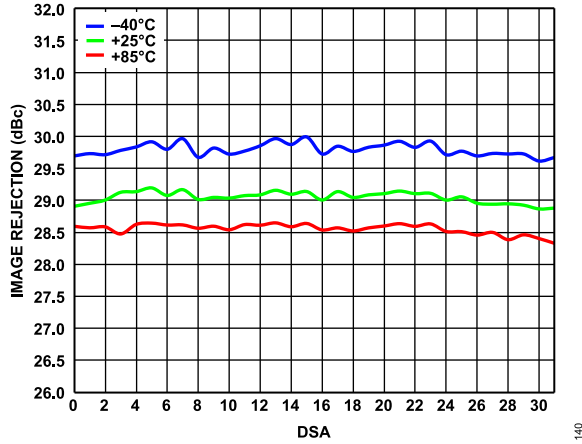

Figure 39. Image Rejection vs. DSA over Temperature, LO Frequency = 10 GHz, LNA Low Gain Mode

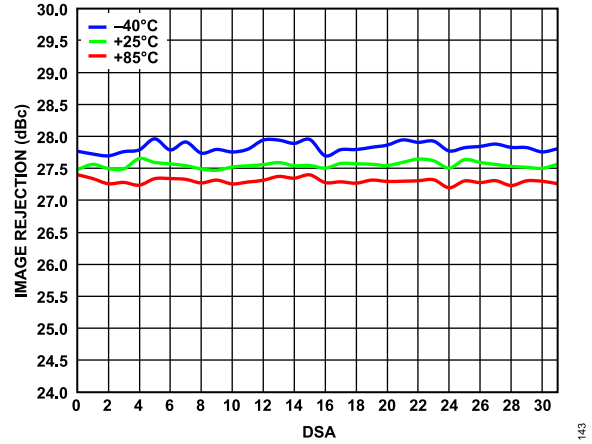

Figure 42. Image Rejection vs. DSA over Temperature, LO Frequency = 10 GHz, LNA High Gain Mode

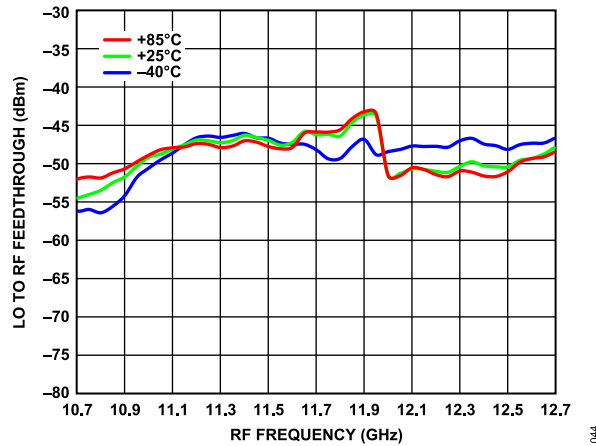

Figure 40. LO to RF Feedthrough vs. RF Frequency over Temperature, LNA Low Gain Mode

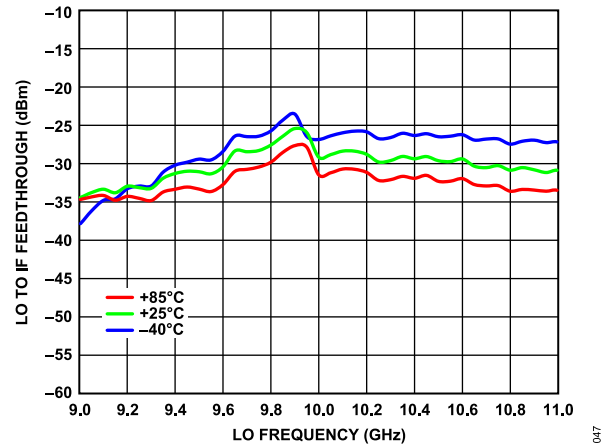

Figure 43. LO to IF Feedthrough vs. LO Frequency over Temperature, LNA Low Gain Mode

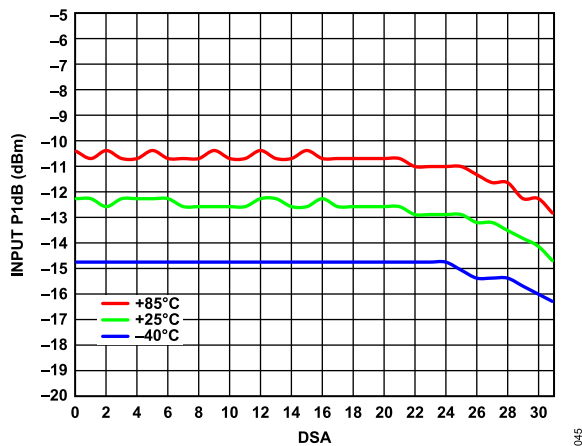

Figure 41. Input P1dB vs. DSA over Temperature, LO Frequency = 10 GHz, LNA High Gain Mode

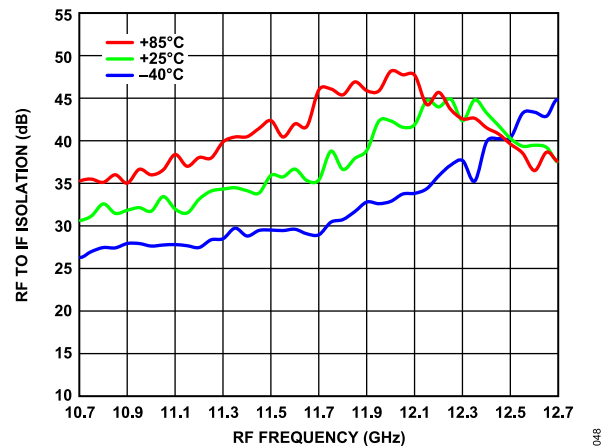

Figure 44. RF to IF Isolation vs. RF Frequency over Temperature, LNA Low Gain Mode

TYPICAL PERFORMANCE CHARACTERISTICS

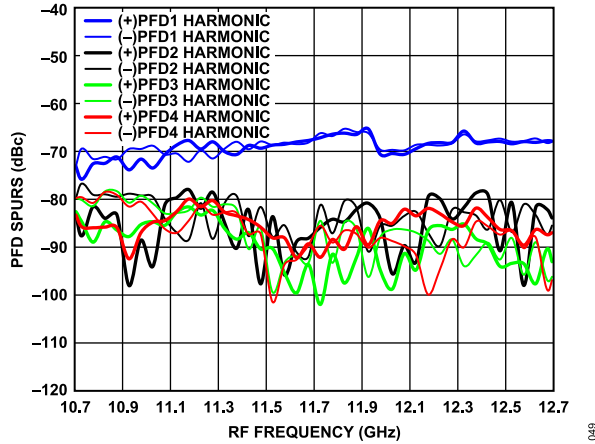

Figure 45. Phase Frequency Detector (PFD) Spurs vs. RF Frequency, LNA Low Gain Mode, Measured from IF Output Power Level

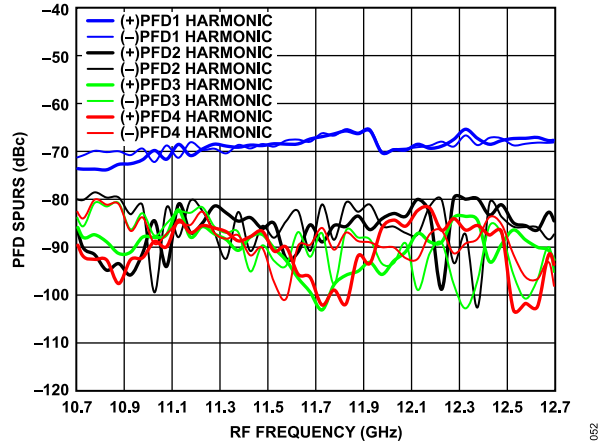

Figure 48. PFD Spurs vs. RF Frequency, LNA High Gain Mode, Measured from IF Output Power Level

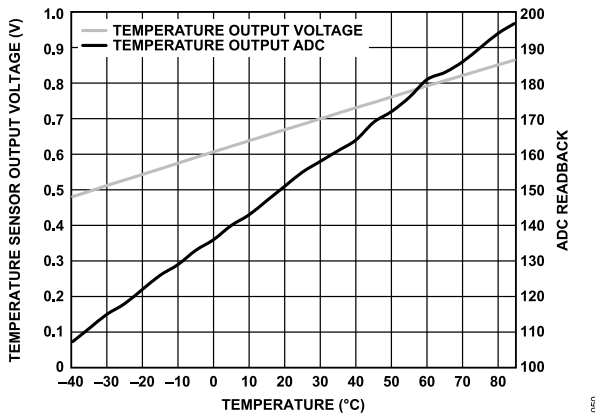

Figure 46. Temperature Sensor Output Voltage and ADC Readback vs. Temperature, LO Frequency = 10 GHz

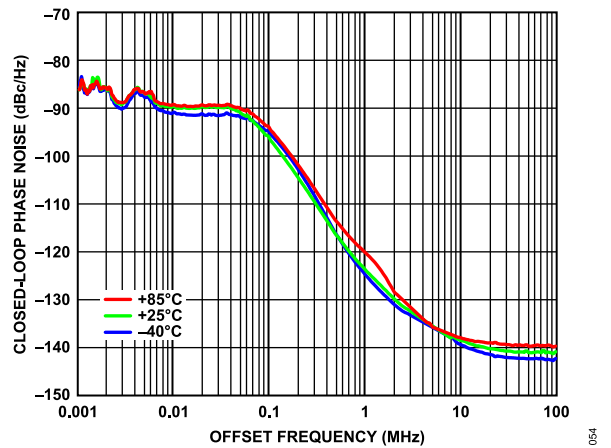

Figure 49. Closed-Loop Phase Noise vs. Offset Frequency over Temperature, LO = 10 GHz

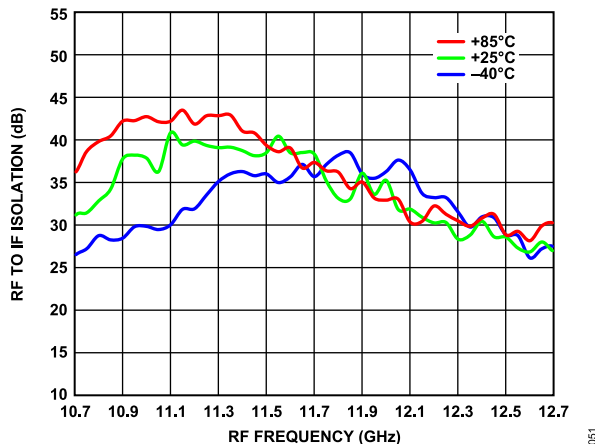

Figure 47. RF to IF Isolation vs. RF Frequency over Temperature, LNA High Gain Mode

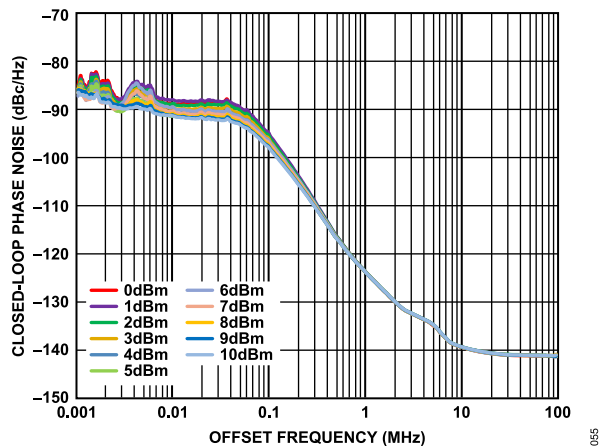

Figure 50. Closed-Loop Phase Noise vs. Offset Frequency over Reference Input Power

TYPICAL PERFORMANCE CHARACTERISTICS

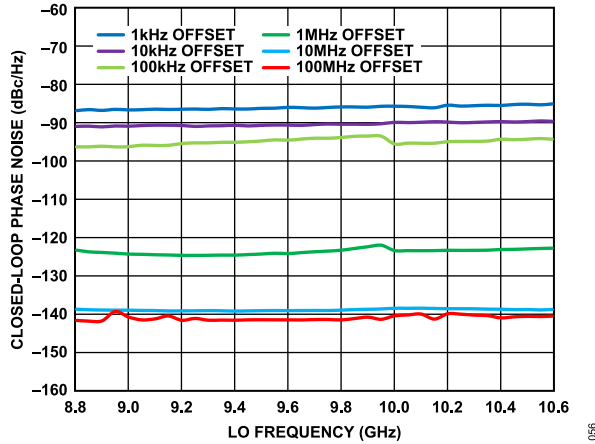

Figure 51. Closed-Loop Phase Noise vs. LO Frequency over Offset Frequency

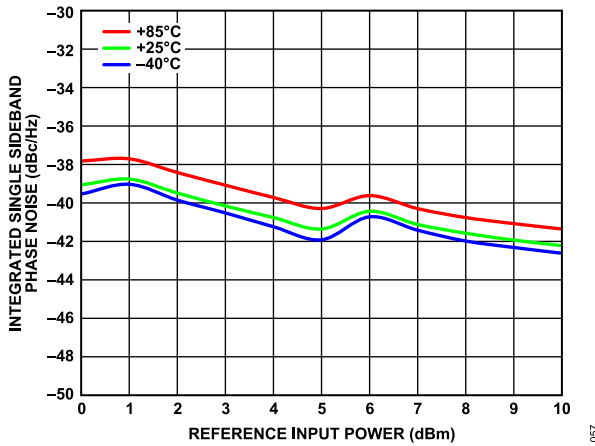

Figure 52. Integrated Single Sideband Phase Noise vs. Reference Input Power over Temperature, Offset Frequency = 1 kHz to 125 MHz

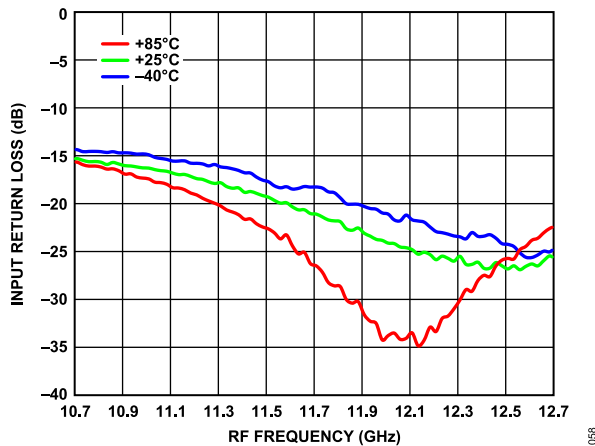

Figure 53. Input Return Loss vs. RF Frequency over Temperature, LO Frequency = 10 GHz



TYPICAL PERFORMANCE CHARACTERISTICS

MAXIMUM ATTENUATION PERFORMANCE: DSA (REGISTER 0X300) = 0

T<sub>A</sub> = 25°C, IF = 2 GHz, VCC = 3.3 V, clock reference input power = 3 dBm, upper sideband selected, unless otherwise noted.

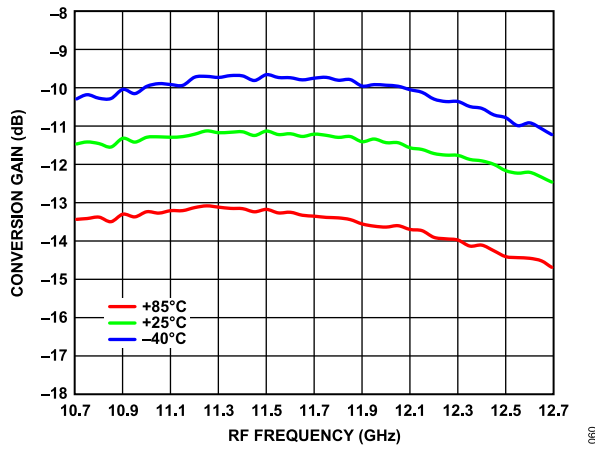

Figure 54. Conversion Gain vs. RF Frequency over Temperature, LNA Low Gain Mode

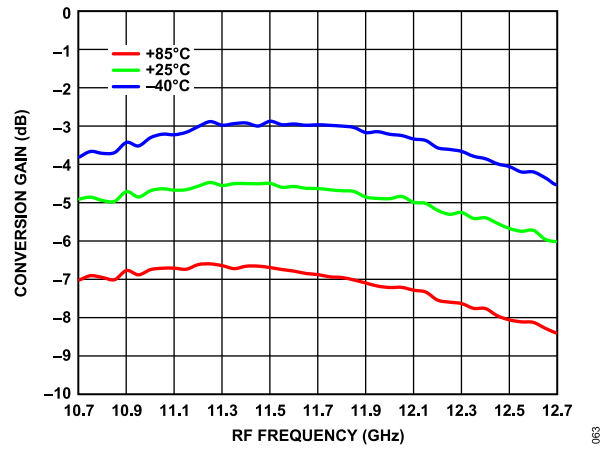

Figure 57. Conversion Gain vs. RF Frequency over Temperature, LNA High Gain Mode

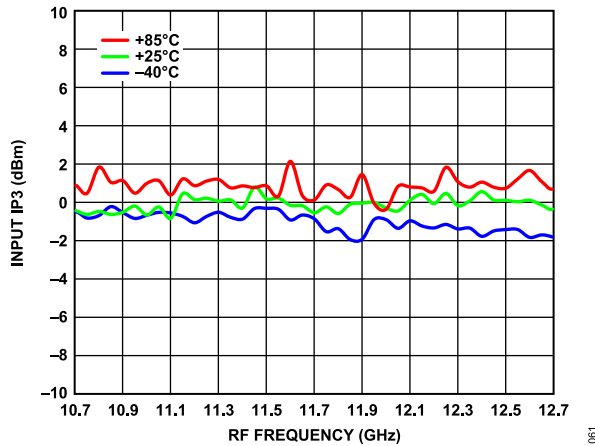

Figure 55. Input IP3 vs. RF Frequency over Temperature, LNA Low Gain Mode

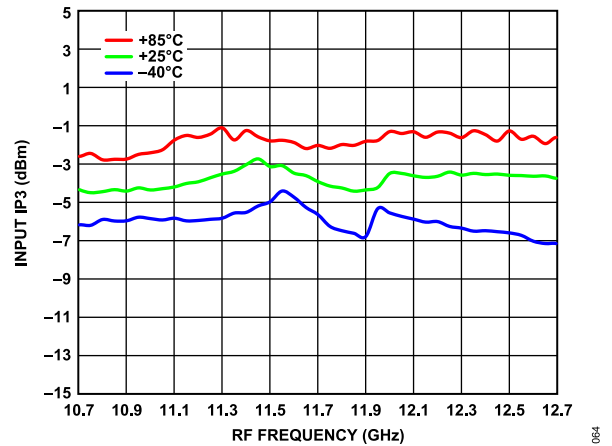

Figure 58. Input IP3 vs. RF Frequency over Temperature, LNA High Gain Mode

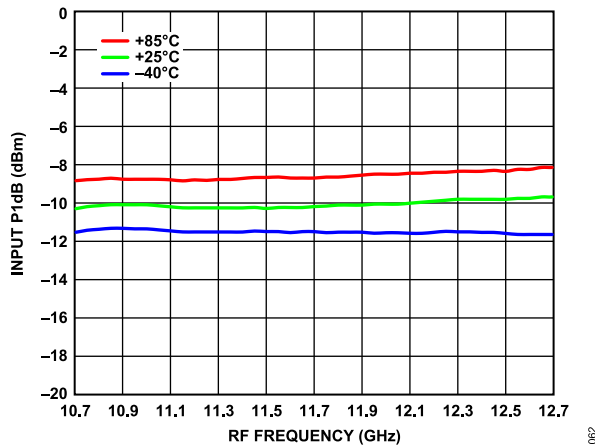

Figure 56. Input P1dB vs. RF Frequency over Temperature, LNA Low Gain Mode

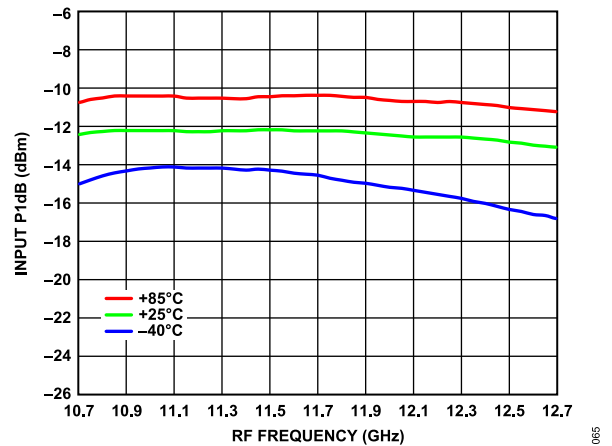

Figure 59. Input P1dB vs. RF Frequency over Temperature, LNA High Gain Mode

TYPICAL PERFORMANCE CHARACTERISTICS

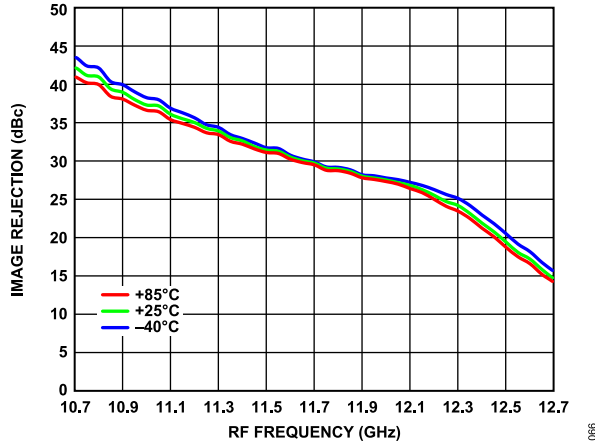

Figure 60. Image Rejection vs. RF Frequency over Temperature, LNA Low Gain Mode

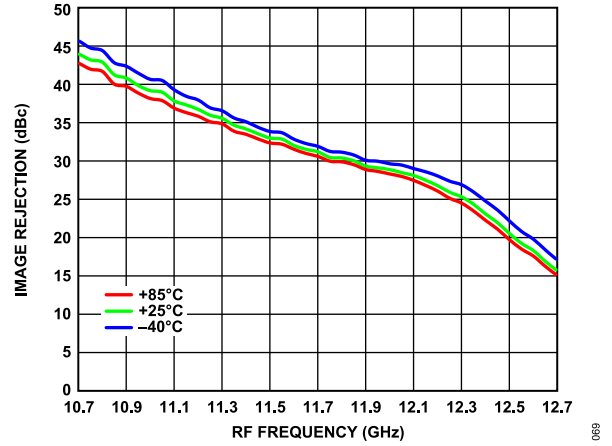

Figure 63. Image Rejection vs. RF Frequency over Temperature, LNA High Gain Mode

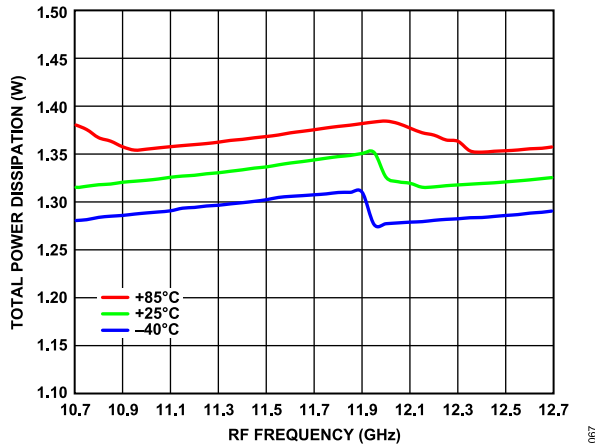

Figure 61. Total Power Dissipation vs. RF Frequency over Temperature, LNA Low Gain Mode

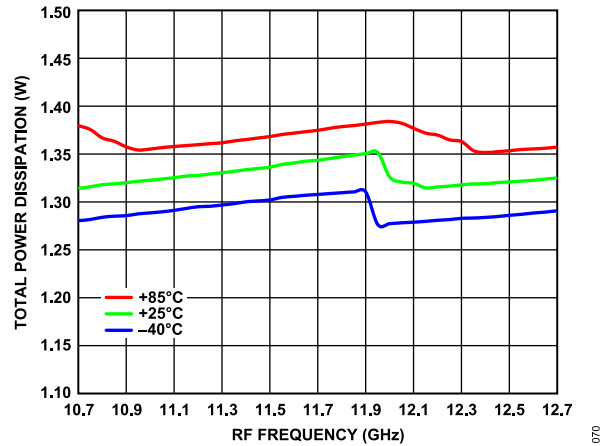

Figure 64. Total Power Dissipation vs. RF Frequency over Temperature, LNA High Gain Mode

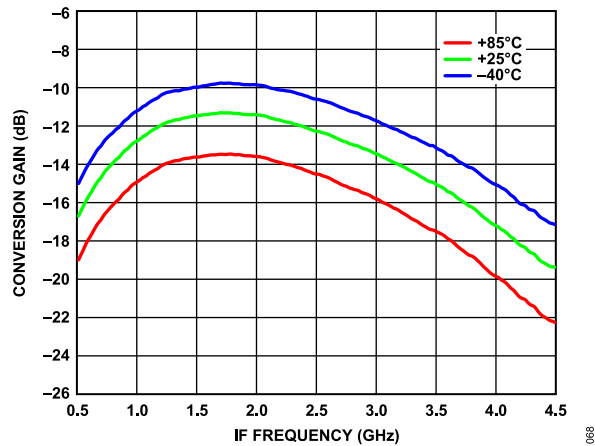

Figure 62. Conversion Gain vs. IF Frequency over Temperature, LNA Low Gain Mode

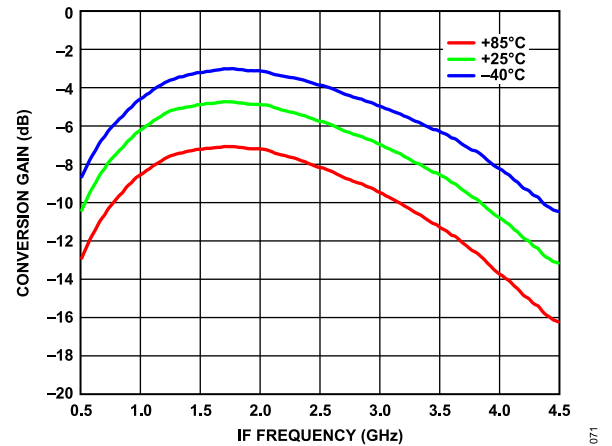

Figure 65. Conversion Gain vs. IF Frequency over Temperature, LNA High Gain Mode

TYPICAL PERFORMANCE CHARACTERISTICS

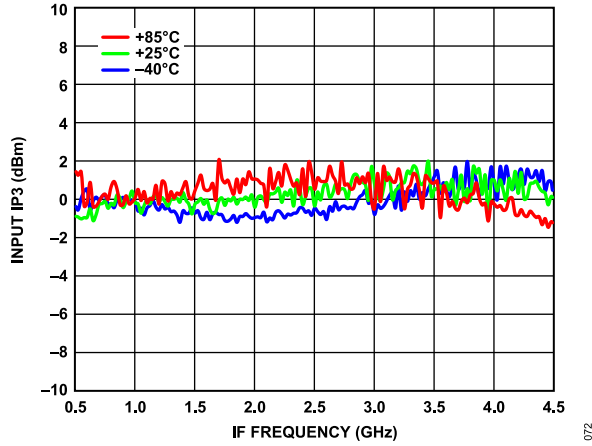

Figure 66. Input IP3 vs. IF Frequency over Temperature, LNA Low Gain Mode

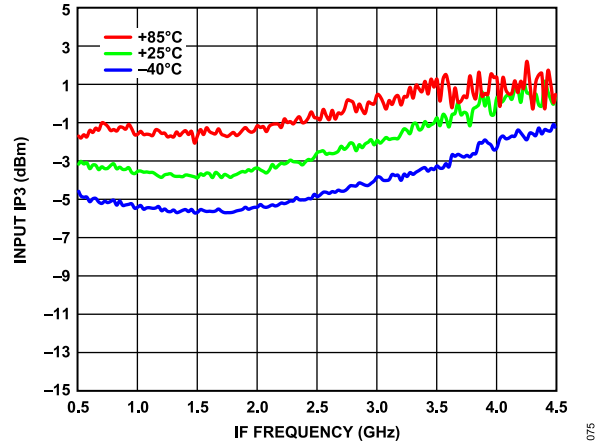

Figure 69. Input IP3 vs. IF Frequency over Temperature, LNA High Gain Mode

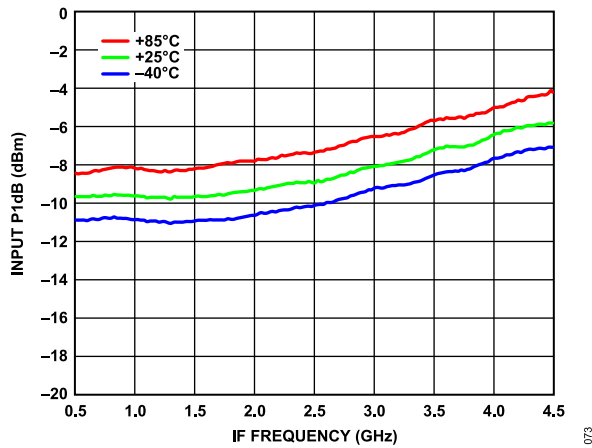

Figure 67. Input P1dB vs. IF Frequency over Temperature, LNA Low Gain Mode

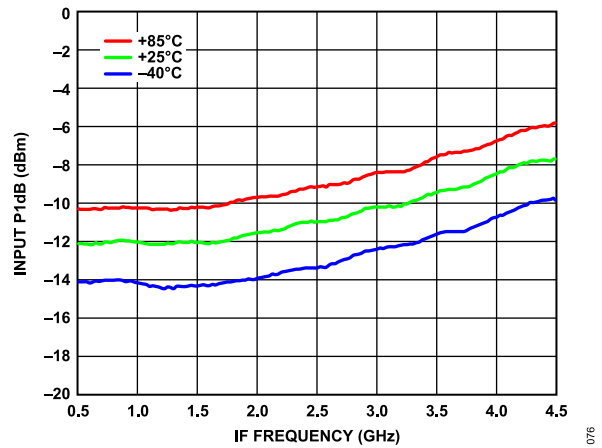

Figure 70. Input P1dB vs. IF Frequency over Temperature, LNA High Gain Mode

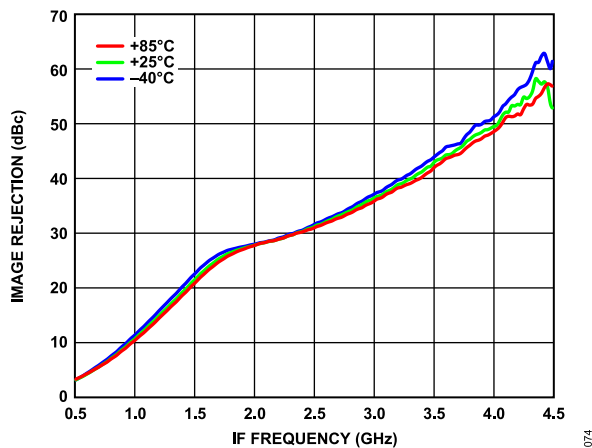

Figure 68. Image Rejection vs. IF Frequency over Temperature, LNA Low Gain Mode

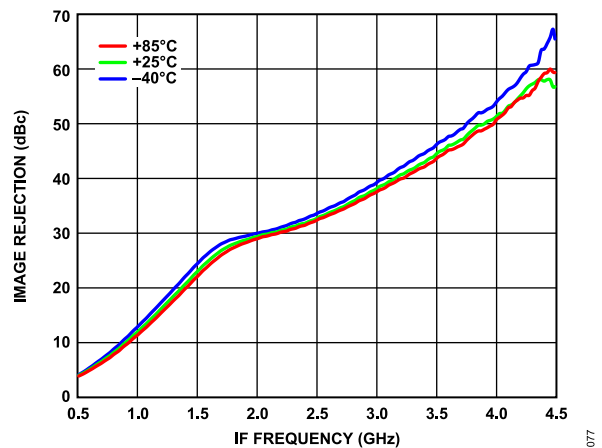

Figure 71. Image Rejection vs. IF Frequency over Temperature, LNA High Gain Mode

## TYPICAL PERFORMANCE CHARACTERISTICS

## SPURIOUS PERFORMANCE

$T_A = 25^\circ\text{C}$ ,  $IF = 2\text{ GHz}$ ,  $V_{CC} = 3.3\text{ V}$ , minimum attenuation (DSA Register 0x300 = 31), clock reference input power = 3 dBm, upper sideband selected. Mixer spurious products are measured in dBc from the IF output power level. Spur values are  $(M \times RF) - (N \times LO)$ .

 **$M \times N$  Spurious Outputs,  $RF = 10.7\text{ GHz}$ ,  $LO = 8.7\text{ GHz}$ , LNA Low Gain Mode**

		$N \times LO$					
		0	1	2	3	4	5
$M \times RF$	0	N/A	18	27	35	$\geq 100$	$\geq 100$
	1	52	0	46	60	92	$\geq 100$
	2	83	92	67	79	78	$\geq 100$
	3	$\geq 100$	$\geq 100$	$\geq 100$	$\geq 100$	$\geq 100$	$\geq 100$
	4	$\geq 100$	$\geq 100$	$\geq 100$	$\geq 100$	$\geq 100$	88
	5	$\geq 100$	$\geq 100$	$\geq 100$	$\geq 100$	$\geq 100$	98

 **$M \times N$  Spurious Outputs,  $RF = 10.7\text{ GHz}$ ,  $LO = 8.7\text{ GHz}$ , LNA High Gain Mode**

		$N \times LO$					
		0	1	2	3	4	5
$M \times RF$	0	N/A	33	34	41	$\geq 100$	$\geq 100$
	1	59	0	44	62	88	$\geq 100$
	2	81	82	60	80	72	$\geq 100$
	3	$\geq 100$	$\geq 100$	$\geq 100$	78	83	$\geq 100$
	4	$\geq 100$	$\geq 100$	$\geq 100$	$\geq 100$	$\geq 100$	90
	5	$\geq 100$	$\geq 100$	$\geq 100$	$\geq 100$	$\geq 100$	$\geq 100$

 **$M \times N$  Spurious Outputs,  $RF = 11.7\text{ GHz}$ ,  $LO = 9.7\text{ GHz}$ , LNA Low Gain Mode**

		$N \times LO$					
		0	1	2	3	4	5
$M \times RF$	0	N/A	18	39	$\geq 100$	$\geq 100$	$\geq 100$
	1	58	0	53	57	$\geq 100$	$\geq 100$
	2	81	86	69	79	81	$\geq 100$
	3	$\geq 100$	$\geq 100$	$\geq 100$	91	$\geq 100$	$\geq 100$
	4	$\geq 100$	$\geq 100$	$\geq 100$	$\geq 100$	$\geq 100$	99
	5	$\geq 100$	$\geq 100$	$\geq 100$	$\geq 100$	$\geq 100$	95

 **$M \times N$  Spurious Outputs,  $RF = 11.7\text{ GHz}$ ,  $LO = 9.7\text{ GHz}$ , LNA High Gain Mode**

		$N \times LO$					
		0	1	2	3	4	5
$M \times RF$	0	N/A	25	44	$\geq 100$	$\geq 100$	$\geq 100$
	1	67	0	51	58	$\geq 100$	$\geq 100$
	2	77	80	62	71	73	$\geq 100$
	3	$\geq 100$	$\geq 100$	$\geq 100$	75	86	$\geq 100$
	4	$\geq 100$	$\geq 100$	$\geq 100$	$\geq 100$	$\geq 100$	$\geq 100$
	5	$\geq 100$	$\geq 100$	$\geq 100$	$\geq 100$	$\geq 100$	$\geq 100$

 **$M \times N$  Spurious Outputs,  $RF = 12.7\text{ GHz}$ ,  $LO = 10.7\text{ GHz}$ , LNA Low Gain Mode**

		$N \times LO$					
		0	1	2	3	4	5
$M \times RF$	0	N/A	21	43	$\geq 100$	$\geq 100$	$\geq 100$
	1	58	0	60	65	$\geq 100$	$\geq 100$
	2	87	87	73	87	97	$\geq 100$
	3	$\geq 100$	$\geq 100$	$\geq 100$	86	$\geq 100$	$\geq 100$
	4	$\geq 100$	$\geq 100$	$\geq 100$	$\geq 100$	$\geq 100$	85
	5	$\geq 100$	$\geq 100$	$\geq 100$	$\geq 100$	$\geq 100$	97

 **$M \times N$  Spurious Outputs,  $RF = 12.7\text{ GHz}$ ,  $LO = 10.7\text{ GHz}$ , LNA High Gain Mode**

		$N \times LO$					
		0	1	2	3	4	5
$M \times RF$	0	N/A	27	48	$\geq 100$	$\geq 100$	$\geq 100$
	1	52	0	59	67	$\geq 100$	$\geq 100$
	2	84	82	69	99	88	$\geq 100$
	3	$\geq 100$	$\geq 100$	$\geq 100$	76	96	$\geq 100$
	4	$\geq 100$	$\geq 100$	$\geq 100$	$\geq 100$	$\geq 100$	89
	5	$\geq 100$	$\geq 100$	$\geq 100$	$\geq 100$	$\geq 100$	$\geq 100$

## THEORY OF OPERATION

The ADMV4640 is a microwave downconverter optimized for various SATCOM user terminals operating in the 10.7 GHz to 12.7 GHz frequency range. See Figure 1 for a functional block diagram of the device. The ADMV4640 digital settings are controlled via the SPI.

### REFERENCE INPUT STAGE

The reference input stage, as shown in Figure 72, can be driven by an external, singled-ended 25 MHz source. Ensure the external dc block is used at the reference input.

### REFERENCE DOUBLER, R COUNTER, AND REFERENCE DIVIDE BY 2

An internal, reference doubler ( $\times 2$  doubler block, see Figure 72) generates higher phase frequency detector frequencies ( $f_{PFD}$ ). Use the DOUBLER\_EN bit (Register 0x20E, Bit 3) to enable the reference doubler.

There are two frequency dividers: a 5-bit R divider counter (1 to 32 allowed) and a divide by 2 ( $\div 2$  block, see Figure 72). These dividers divide the input reference frequency ( $f_{REF}$ ) down to produce a lower  $f_{PFD}$ . Use the R\_DIV bits in Register 0x20C, Bits[4:0] to set the R counter.

The reference divide by 2 block is enabled by using the RDIV2\_SEL bit (Register 0x20E, Bit 0).

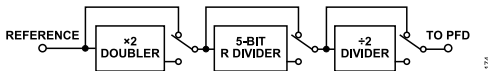

Figure 72. Reference Input Path Block Diagram

### INT MODE AND N COUNTER

The ADMV4640 synthesizer operates in INT mode.

The N counter allows a division ratio in the phase-locked loop (PLL) feedback path from the VCO. The division ratio is determined by the INT bit value. Use Register 0x200 and Register 0x201 to set the INT bit values.

The INT bit value, in conjunction with the reference path, allows VCO frequencies spaced by the resolution of the  $f_{PFD}$  to be generated.

To calculate  $f_{PFD}$  with  $f_{REF}$  and the reference path configuration parameters, use the following equation:

$$f_{PFD} = f_{REF} \times \frac{1+D}{R \times (1+T)} \quad (1)$$

where:

$D$  is the reference doubler bit (0 or 1).

$R$  is the reference divide ratio of the binary, 5-bit programmable counter (1 to 31).

$T$  is the reference divide by 2 bit (0 or 1).

To calculate the VCO frequency ( $f_{VCO}$ ), use the following equation:

$$f_{VCO} = \frac{f_{LO}}{2} = f_{PFD} \times N \quad (2)$$

where:

$f_{LO}$  is the frequency of the LO driving the mixer.

$N$  is the desired value of INT, where INT is the 16-bit integer value (0 to 65,535).

### PHASE FREQUENCY DETECTOR (PFD) AND CP

The PFD takes inputs from the R counter and N counter to produce an output that is proportional to the phase and frequency differences between them. This proportional information is output to a CP circuit that generates current to drive an external loop filter. The loop filter is used to appropriately increase or decrease the VTUNE tuning voltage.

Figure 73 shows a simplified schematic of the PFD and CP. U1 and U2 are two D type flip flops and U3 is an AGND gate. The PFD has a fixed delay element that is used to ensure that there is no dead zone in the PFD transfer function for consistent reference spur levels.

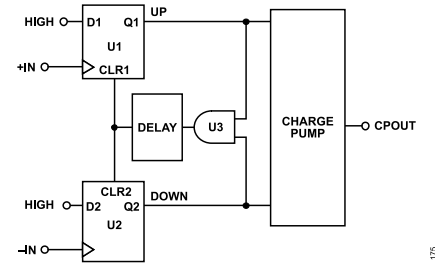

Figure 73. PFD and CP Simplified Schematic

### LOOP FILTER AND CP CURRENT

Defining a loop filter for a PLL depends on the PFD frequency, the N counter value, the tuning sensitivity characteristics ( $k_{VCO}$ ) of the VCO, and the selected CP current. A lower  $f_{PFD}$  allows the PLL to operate in INT mode, which can eliminate integer boundary spurs at the expense of higher in-band phase noise performance. Take care with frequency planning and  $f_{PFD}$  selection to ensure that the appropriate in band phase noise performance is met with acceptable spur levels for the end application.

The loop filter, as implemented on the ADMV4640-EVALZ evaluation board, is shown in Figure 74. The CP current ( $I_{CP}$ ) is set by Register 0x22E. The default register value of 0x0E is recommended.

For additional guidance with loop filter simulations on the ADMV4640, contact Analog Devices, Inc., for technical support.

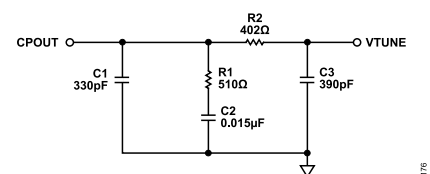

Figure 74. Recommended Loop Filter Schematic

## THEORY OF OPERATION

### ON-CHIP MUXOUT PIN

The MUXOUT pin allows access to various internal signals and provides a digital lock detect function. A diagram of the MUXOUT pin is shown in [Figure 75](#). The state of the MUXOUT pin is determined from the MUX\_SEL value in Register 0x24E.

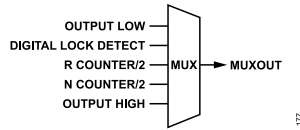

Figure 75. MUXOUT Pin Diagram

### ANALOG MUX BLOCK, AGPIO PIN, AND ADC

The on-chip AGPIO pin can be used either as an external analog input or output of the device analog multiplexer (mux) signal. The analog mux is a block inside the ADMV4640. When the AGPIO signal is used as an input, the signal is transferred to the on-chip analog mux. The analog mux selects between the temperature sensor and the AGPIO signal. An on-chip ADC samples the signals from the analog mux.

To enable the ADC to sample the analog mux signal, take the following steps:

1. Make sure the reference input is fed to ADMV4640.
2. Set Register 0x301, Bits[2:0] to 6 or 7 to select between the temperature sensor and AGPIO signal as the analog mux output. If the AGPIO signal is selected, set Register 0x301, Bit 3 to 1 so that AGPIO becomes the external signal input.
3. Set Register 0x302, Bits[3:0] to 0x00 to disable the ADC log scale and reset ADC.
4. Set Register 0x302 Bits[1:0] to 0x03 to enable and start ADC sampling.
5. Wait for 1ms.
6. Set Register 0x302, Bit 1 to 0.
7. Read the ADC value from Register 0x304.
8. Set Register 0x302, Bits[1:0] to 0x00 to turn off the ADC.

The default ADC input voltage range is 0 V to 1.1 V. If a higher input range is required, set Register 0x302, Bit 2 to 1 to halve the input voltage before sampling. The voltage range is then 0 V to 2.2 V.

Enable or disable the ADC output log scale by setting Register 0x302, Bit 3 to 1 or 0.

The AGPIO pin can also be used as an output to transfer the analog mux signal to the AGPIO pin. To set the AGPIO pin as the output, take the following steps:

1. Set Register 0x301, Bit 3 to 0 to set the AGPIO pin to be the output of the internal analog mux signal.
2. Set the value of Register 0x301, Bits[2:0] to 110 to select the temperature sensor as the analog mux output.
3. Set Register 0x302, Bit 0 to 0 to turn off the ADC.

### GPIOX PINS

There are three GPIOx pins for input/output (I/O) control. Use Register 0x307 to set the GPIO settings and see the [Register Details](#) section for more details.

### DIGITAL LOCK DETECT AND MUTE\_IF\_UNLOCKED BIT

The digital lock detect function is output on the MUXOUT pin and has two adjustable settings in Register 0x214. The first setting, LD\_BIAS, adjusts an internal precision window. The second setting, LD\_COUNT, adjusts the consecutive cycle count to declare the PLL lock. Keep the default register value for these two settings. The lock detect status can also be obtained from Register 0x24D, Bit 0.

The MUTE\_IF\_UNLOCKED bit (Register 0x103, Bit 0) allows the output to be muted if the PLL is unlocked. Set the bit to 1 to enable this function.

### SIGNAL CHAIN BIAS REGISTER, MASK REGISTER, RX\_MUTE PIN, AND RXON PIN

RXON and RX\_MUTE are two on-chip pins. These pins are signal masks that command the chip to block certain stages. These two pins can be pulled to high (3.3 V) or low (ground). Use the mute-mask control register (Register 0x101) and the on-mask control register (Register 0x102) to determine which stages in the signal path are masked by these two pins.

Register 0x100 (bias control), 0x101 (mute-mask control), and 0x102 (on-mask control) control the on/off status for each stage in the signal path.

Register 0x100 is a bias control register. Set each bit in this register to 1 or 0 to enable or disable the corresponding stage bias.

Register 0x101 is a mute-mask control register. Set each bit in this register to 1 to enable the RX\_MUTE pin to mask the corresponding stage.

For example, when the LO amplifier mute-mask control bit is on (Register 0x101, Bit 1 = 1) and the RX\_MUTE pin on the chip is pulled high, the LO amplifier is blocked.

[Table 5](#) shows the truth table detailing how the RX\_MUTE pin and the mute-mask control register work together to block signal stages. The MUTE\_IF\_UNLOCKED bit (Register 0x103, Bit 0) has the same muting effect as the RX\_MUTE pin when enabled.

Register 0x102 is an on-mask control register. Set each bit in this register to 1 to enable the RX\_ON pin to mask the corresponding stage. For the RX\_ON pin to work, the corresponding stage bias control in Register 0x100 must be on and the RX\_MUTE pin and mute-mask control register must be disabled.

For example, when the LO amplifier on-mask control bit is on (Register 0x102, Bit 1 = 1) and the RX\_ON pin on the chip is pulled low, the LO amplifier is blocked.

## THEORY OF OPERATION

Table 6 shows the truth table detailing how the RX\_ON pin and the on-mask control register work together to block signal stages.

### SPI CONFIGURATION

The ADMV4640 SPI configures the device for specific functions or operations via the 4-pin SPI port. This interface provides users with added flexibility and customization. The SPI consists of the following four control lines: SCLK, SDI, SDO, and  $\overline{CS}$ . The ADMV4640 protocol consists of a write or read bit followed by 15 register address bits and eight data bits. The address field and data field are organized LSB first and end with the MSB.

Set the MSB to 0 for a write operation and set the MSB to 1 for a read operation.

The write cycle sampling must be performed on the rising edge of the SCLK control line. The 24 bits of the serial write address and data are shifted in on the SDI control line, MSB to LSB. The ADMV4640 input logic level for the write cycle supports a 3.3 V interface.

For a read cycle, the read/write (R/W) bit and the 15 bits of address shift in on the rising edge of the SCLK pin on the SDI control line. Then, eight bits of serial read data shift out on the SDO pin LSB first and on the falling edge of SCLK. The output logic level for a read cycle is 3.3 V. The output drivers of the SDO pin are enabled after the last rising edge of SCLK of the instruction cycle and remain active until the end of the read cycle. When the  $\overline{CS}$  control line is deasserted in a read operation, the SDO pin returns to high impedance until the next read transaction. The  $\overline{CS}$  pin is active low and must be deasserted at the end of the write or read sequence.

An active low input on the  $\overline{CS}$  pin starts and gates a communication cycle. The  $\overline{CS}$  pin allows multiple ADMV4640 devices to be used on the same serial communications lines. The SDO pin goes to a high impedance state when the  $\overline{CS}$  pin is high. During the communication cycle, the  $\overline{CS}$  pin must stay low.

The SPI communications protocol follows the Analog Devices SPI standard. For more information, see the [ADI-SPI Serial Control Interface Standard \(Rev 1.0\)](#) guide.

**Table 5. Signal Stage Status Truth Table Using RX\_MUTE and Mute-Mask Control**

RX_MUTE Pin    MUTE_IF_UNLOCKED Bit <sup>1</sup>	Mute-Mask Control Register 0x101 <sup>1</sup>	RXON Pin <sup>1</sup>	On-Mask Control Register 0x102 <sup>1</sup>	Bias Control Register 0x100 <sup>1</sup>	Result (1 is On, 0 is Off) <sup>1</sup>
1	1	0 or 1	0 or 1	0 or 1	0
1	0			Controlled by RXON pin	
0	1			Controlled by RXON pin	

<sup>1</sup> The 0 and 1 settings apply to all user specified bits in the listed register.

### VCO AUTOCALIBRATION AND AUTOMATIC LEVEL CONTROL

The multicore VCO uses an internal autocalibration and automatic level control (ALC) routine that optimizes the VCO settings for a user defined frequency, and locks the PLL after the lower portion of the N counter integer value (Register 0x200) is programmed.

### DOUBLE BUFFERED REGISTERS

Register 0x20C, Register 0x20E, and Register 0x201 are double buffered registers that take effect only after a write to the lower portion of the integer value (INT\_L, Register 0x200). Register 0x200 applies any changes to these double buffered registers and initiates the autocalibration routine.

The recommended programming sequence for double buffered registers is as follows:

1. Program R\_DIV.
2. Program RDIV2\_SEL.
3. Program DOUBLER\_EN.
4. Program INT\_H.
5. Program INT\_L.

### INITIALIZATION REGISTERS

The recommended programming sequence when initializing the device is as follows:

1. Register 0x000 = 0x99
2. Register 0x000 = 0x18
3. Register 0x103 = 0x00
4. Register 0x22B = 0x0B
5. Register 0x22F = 0x27
6. Register 0x308 = 0x02
7. Register 0x309 = 0x33
8. Register 0x30A = 0x48
9. Register 0x30D = 0x09
10. Register 0x30E = 0x09
11. Register 0x300 = 0x1F

## THEORY OF OPERATION

Table 6. Signal Stage Status Truth Table Using RX\_ON and On-Mask Control

RX_MUTE Pin    MUTE_IF_UNLOCKED Bit <sup>1</sup>	Mute-Mask Control Register 0x101 <sup>1</sup>	RXON Pin <sup>1</sup>	On-Mask Control Register 0x102 <sup>1</sup>	Bias Control Register 0x100 <sup>1</sup>	Result (1 is On, 0 is Off) <sup>1</sup>
0 or 1	0	0 or 1	0	0	0
0 or 1	0	0 or 1	0	1	1
0 or 1	0	0	1	0 or 1	0
0 or 1	0	1	1	0	0
0 or 1	0	1	1	1	1
0	0 or 1	0 or 1	0	0	0
0	0 or 1	0 or 1	0	1	1
0	0 or 1	0	1	0 or 1	0
0	0 or 1	1	1	0	0
0	0 or 1	1	1	1	1

<sup>1</sup> The 0 and 1 settings apply to all user specified bits in the listed register.



## REGISTER SUMMARY

Table 7. Register Summary

Reg	Name	Bits	Bit 7	Bit 6	Bit 5	Bit 4	Bit 3	Bit 2	Bit 1	Bit 0	Reset	RW	
0x000	SPI_CONFIG_1	[7:0]	SOFT-RESET_	LSB_FIRST_	ENDIAN_	SDO_ACTIVE_	SDO_ACTIVE_	ENDIAN	LSB_FIRST	SOFT-RESET	0x00	R/W	
0x004	PRODUCT_ID_L	[7:0]	PRODUCT_ID_L								0x40	R	
0x005	PRODUCT_ID_H	[7:0]	PRODUCT_ID_H								0x46	R	
0x100	SIGCHAIN_ENABLE	[7:0]	RF_MASTER_BIAS_CONTROL	SYNTH_BIAS_CONTROL	RESERVED	ATT6DB_BIAS_CONTROL	LNASTG2_BIAS_CONTROL	LNASTG1_BIAS_CONTROL	AMPLO_BIAS_CONTROL	AMPIF_BIAS_CONTROL	0xDF	R/W	
0x101	MUTE_MASK_CONTROL	[7:0]	BIASRF_MUTE_MASK_CONTROL	SYNTH_MUTE_MASK_CONTROL	RESERVED	ATT6DB_MUTE_MASK_CONTROL	LNASTG2_MUTE_MASK_CONTROL	LNASTG1_MUTE_MASK_CONTROL	AMPLO_MUTE_MASK_CONTROL	AMPIF_MUTE_MASK_CONTROL	0xBF	R/W	
0x102	ON_MASK_CONTROL	[7:0]	RF_MASTER_ON_MASK_CONTROL	SYNTH_ON_MASK_CONTROL	RESERVED	ATT6DB_ON_MASK_CONTROL	LNASTG2_ON_MASK_CONTROL	LNASTG1_ON_MASK_CONTROL	AMPLO_ON_MASK_CONTROL	RESERVED	0xFF	R/W	
0x103	MUTE_UNLOCK	[7:0]	RESERVED							MUTE_IF_UNLOCKED	0x01	R/W	
0x200	INT_L	[7:0]	INT[7:0]								0x90	R/W	
0x201	INT_H	[7:0]	INT[15:8]								0x01	R/W	
0x20B	SYNTH	[7:0]	RESERVED						PRE_SEL	EN_FBDIV	0x01	R/W	
0x20C	R_DIV	[7:0]	RESERVED			R_DIV					0x01	R/W	
0x20E	REFERENCE	[7:0]	RESERVED				DOUBLER_EN	RESERVED		RDIV2_SEL	0x04	R/W	
0x214	LOCK_DETECT_CONFIG	[7:0]	LD_BIAS		LD_COUNT			RESERVED			0x48	R/W	
0x218	SYNTH_LOCK_TIMEOUT	[7:0]	RESERVED				SYNTH_LOCK_TIMEOUT				0x1F	R/W	
0x21C	VCO_TIMEOUT_L	[7:0]	VCO_TIMEOUT[7:0]								0x19	R/W	
0x21D	VCO_TIMEOUT_H	[7:0]	RESERVED						VCO_TIMEOUT[9:8]		0x00	R/W	
0x21E	VCO_BAND_DIV	[7:0]	VCO_BAND_DIV								0x10	R/W	
0x22B	MULTI_FUNC_SYNTH_CTRL_022B	[7:0]	RESERVED						RF_PBS		0x09	R/W	
0x22E	CP_CURR	[7:0]	RESERVED				CP_CURRENT				0x0E	R/W	
0x22F	BICP	[7:0]	BICP								0x08	R/W	
0x24D	LOCK_DETECT	[7:0]	RESERVED							LOCK_DETECT	0x00	R	
0x24E	MUXOUT	[7:0]	MUX_SEL								0x00	R/W	
0x300	DSA_CONTROL	[7:0]	RESERVED			SEL_DSA_ATTEN					0x00	R/W	
0x301	AGPIO_CONTROL	[7:0]	RESERVED				SEL_AGPIO	SEL_ADC_INPUT				0x00	R/W
0x302	ADC_	[7:0]	SEL_ADC_CLKDIV			SEL_	SEL_ADC-	ADC_START	EN_ADC	0xCA	R/W		

## REGISTER SUMMARY

Table 7. Register Summary

Reg	Name	Bits	Bit 7	Bit 6	Bit 5	Bit 4	Bit 3	Bit 2	Bit 1	Bit 0	Reset	RW	
	CONTROL						ADCLOG-SCALE	HALF					
0x303	ADC_STATUS	[7:0]	RESERVED					ADC_LATCH-DATA	ADC_BUSY	ADC_EOC	0x01	R	
0x304	ADC_DATA	[7:0]	ADC_DATA									0xE1	R
0x305	GPIO_WRITEVALS	[7:0]	RESERVED				GPIO_WRITEVALS			RESERVED	0x00	R/W	
0x306	GPIO_READVALS	[7:0]	RESERVED				GPIO_READVALS			RESERVED	0x0E	R	
0x307	GPIO_CONTROL	[7:0]	RESERVED	EN_GPIO_OUT			SEL_GPIO_LEVELS			RESERVED	0x00	R/W	
0x308	RFBIAS_CONTROL1	[7:0]	RESERVED				SEL_BIAS_AMP1F				0x08	R/W	
0x309	RFBIAS_CONTROL2	[7:0]	SEL_BIAS_LNASTG2				SEL_BIAS_LNASTG1				0x88	R/W	
0x30A	RFBIAS_CONTROL3	[7:0]	SEL_BIAS_AMPLO2				SEL_BIAS_AMPLO1				0x88	R/W	
0x30D	MIXER_CONTROL1	[7:0]	RESERVED			SEL_MIXLOCM_COARSE_P					0x08	R/W	
0x30E	MIXER_CONTROL2	[7:0]	RESERVED			SEL_MIXLOCM_COARSE_N					0x08	R/W	

REGISTER DETAILS

SPI CONFIGURATION REGISTER

Address: 0x000, Reset: 0x00, Name: SPI\_CONFIG\_1

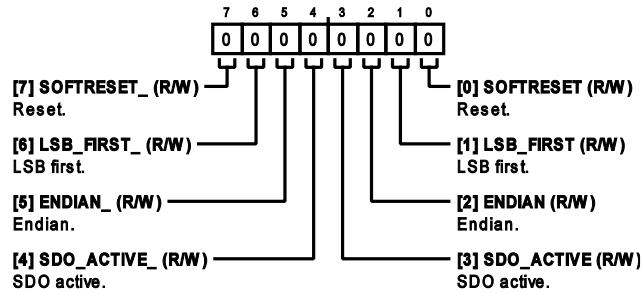
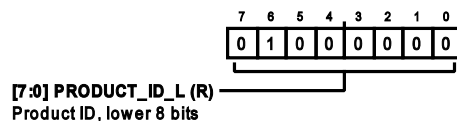

Table 8. Bit Descriptions for SPI\_CONFIG\_1

Bits	Bit Name	Description	Reset	Access
7	SOFTRESET_	Reset. 0: reset not asserted. 1: reset asserted.	0x0	R/W
6	LSB_FIRST_	LSB first. 0: LSB first. 1: MSB first.	0x0	R/W
5	ENDIAN_	Endian. 1: big endian. 0: little endian.	0x0	R/W
4	SDO_ACTIVE_	SDO active. 0: SDO inactive. 1: SDO active.	0x0	R/W
3	SDO_ACTIVE	SDO active. 0: SDO inactive. 1: SDO active.	0x0	R/W
2	ENDIAN	Endian. 0: little endian. 1: big endian.	0x0	R/W
1	LSB_FIRST	LSB first. 0: LSB first. 1: MSB first.	0x0	R/W
0	SOFTRESET	Reset. 0: reset not asserted. 1: reset asserted.	0x0	R/W

Product ID Register Product ID (Lower Eight Bits of 16-Bit Register)

Address: 0x004, Reset: 0x40, Name: PRODUCT\_ID\_L



REGISTER DETAILS

Table 9. Bit Descriptions for PRODUCT\_ID\_L

Bits	Bit Name	Description	Reset	Access
[7:0]	PRODUCT_ID_L	Product ID, lower eight bits.	0x40	R

Product ID Register (Upper Eight Bits of 16-Bit Register)

Address: 0x005, Reset: 0x46, Name: PRODUCT\_ID\_H

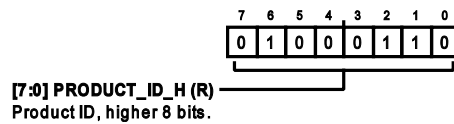

Table 10. Bit Descriptions for PRODUCT\_ID\_H

Bits	Bit Name	Description	Reset	Access
[7:0]	PRODUCT_ID_H	Product ID, higher eight bits.	0x46	R

Bias Control Register

Address: 0x100, Reset: 0xDF, Name: SIGCHAIN\_ENABLE

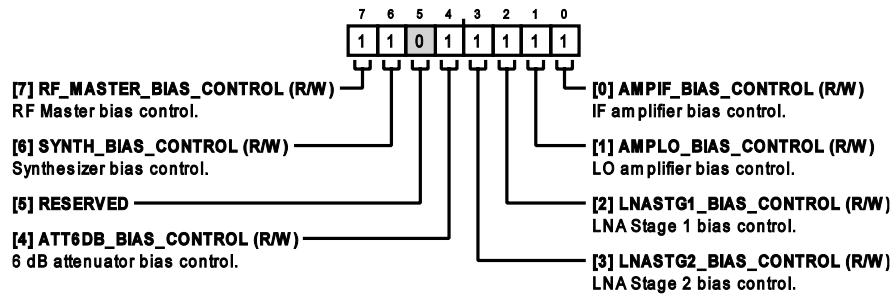

Table 11. Bit Descriptions for SIGCHAIN\_ENABLE

Bits	Bit Name	Description	Reset	Access
7	RF_MASTER_BIAS_CONTROL	RF master bias control. 0: disable. 1: enable.	0x1	R/W
6	SYNTH_BIAS_CONTROL	Synthesizer bias control. 1: enable. 0: disable.	0x1	R/W
5	RESERVED	Reserved.	0x0	R
4	ATT6DB_BIAS_CONTROL	6 dB attenuator bias control. 1: enable. 0: disable.	0x1	R/W
3	LNASTG2_BIAS_CONTROL	LNA Stage 2 bias control. 1: enable. 0: disable.	0x1	R/W
2	LNASTG1_BIAS_CONTROL	LNA Stage 1 bias control. 1: enable. 0: disable.	0x1	R/W

## REGISTER DETAILS

Table 11. Bit Descriptions for SIGCHAIN\_ENABLE

Bits	Bit Name	Description	Reset	Access
1	AMPLO_BIAS_CONTROL	LO amplifier bias control. 1: enable. 0: disable.	0x1	R/W
0	AMPIF_BIAS_CONTROL	IF amplifier bias control. 1: enable. 0: disable.	0x1	R/W

## Mute Mask Control Register

Address: 0x101, Reset: 0xBF, Name: MUTE\_MASK\_CONTROL

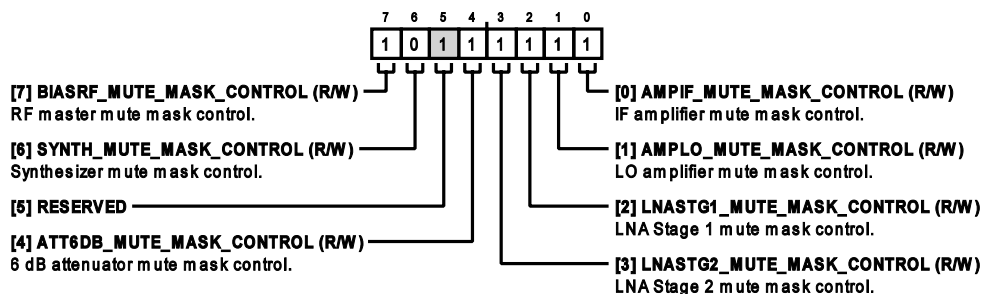

Table 12. Bit Descriptions for MUTE\_MASK\_CONTROL

Bits	Bit Name	Description	Reset	Access
7	BIASRF_MUTE_MASK_CONTROL	RF master mute mask control. 0: disable mute mask. 1: enable mute mask.	0x1	R/W
6	SYNTH_MUTE_MASK_CONTROL	Synthesizer mute mask control. 0: disable mute mask. 1: enable mute mask.	0x0	R/W
5	RESERVED	Reserved.	0x1	R/W
4	ATT6DB_MUTE_MASK_CONTROL	6 dB attenuator mute mask control. 0: disable mute mask. 1: enable mute mask.	0x1	R/W
3	LNAStage2_MUTE_MASK_CONTROL	LNA Stage 2 mute mask control. 0: disable mute mask. 1: enable mute mask.	0x1	R/W
2	LNAStage1_MUTE_MASK_CONTROL	LNA Stage 1 mute mask control. 0: disable mute mask. 1: enable mute mask.	0x1	R/W
1	AMPLO_MUTE_MASK_CONTROL	LO amplifier mute mask control. 0: disable mute mask. 1: enable mute mask.	0x1	R/W
0	AMPIF_MUTE_MASK_CONTROL	IF amplifier mute mask control. 0: disable mute mask. 1: enable mute mask.	0x1	R/W

## REGISTER DETAILS

## On Mask Control Register

Address: 0x102, Reset: 0xFF, Name: ON\_MASK\_CONTROL

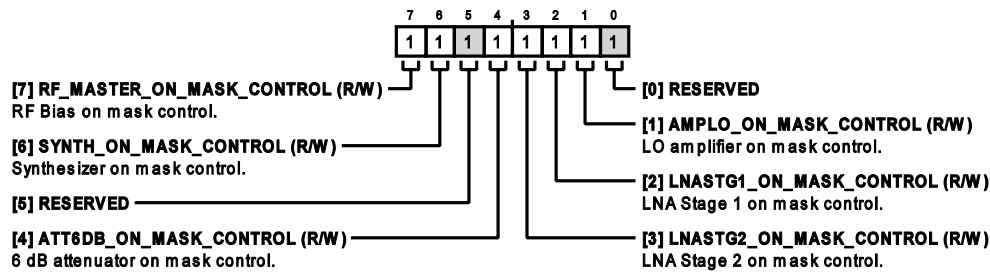

Table 13. Bit Descriptions for ON\_MASK\_CONTROL

Bits	Bit Name	Description	Reset	Access
7	RF_MASTER_ON_MASK_CONTROL	RF bias on mask control. 0: disable on mask. 1: enable on mask.	0x1	R/W
6	SYNTH_ON_MASK_CONTROL	Synthesizer on mask control. 0: disable on mask. 1: enable on mask.	0x1	R/W
5	RESERVED	Reserved.	0x1	R/W
4	ATT6DB_ON_MASK_CONTROL	6 dB attenuator on mask control. 0: disable on mask. 1: enable on mask.	0x1	R/W
3	LNASTG2_ON_MASK_CONTROL	LNA Stage 2 on mask control. 0: disable on mask. 1: enable on mask.	0x1	R/W
2	LNASTG1_ON_MASK_CONTROL	LNA Stage 1 on mask control. 0: disable on mask. 1: enable on mask.	0x1	R/W
1	AMPLO_ON_MASK_CONTROL	LO amplifier on mask control. 0: disable on mask. 1: enable on mask.	0x1	R/W
0	RESERVED	Reserved.	0x1	R/W

## Mute IF Unlock Register

Address: 0x103, Reset: 0x01, Name: MUTE\_UNLOCK

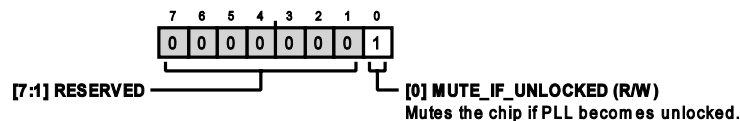

Table 14. Bit Descriptions for MUTE\_UNLOCK

Bits	Bit Name	Description	Reset	Access
[7:1]	RESERVED	Reserved.	0x0	R
0	MUTE_IF_UNLOCKED	Mutes the chip if PLL becomes unlocked.	0x1	R/W

## REGISTER DETAILS

Table 14. Bit Descriptions for MUTE\_UNLOCK

Bits	Bit Name	Description	Reset	Access
		1: enable. 0: disable.		

## Integer Register (Lower Eight Bits)

Address: 0x200, Reset: 0x90, Name: INT\_L

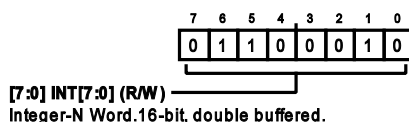

Table 15. Bit Descriptions for INT\_L

Bits	Bit Name	Description	Reset	Access
[7:0]	INT[7:0]	Integer-N Word, 16-bit, double buffered.	0x90	R/W

## Integer Register (Upper Eight Bits)

Address: 0x201, Reset: 0x01, Name: INT\_H

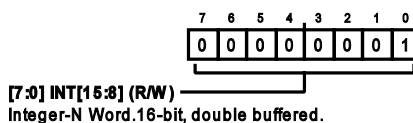

Table 16. Bit Descriptions for INT\_H

Bits	Bit Name	Description	Reset	Access
[7:0]	INT[15:8]	Integer-N Word, 16-bit, double buffered.	0x1	R/W

## Synthesizer Configuration Register

Address: 0x20B, Reset: 0x01, Name: SYNTH

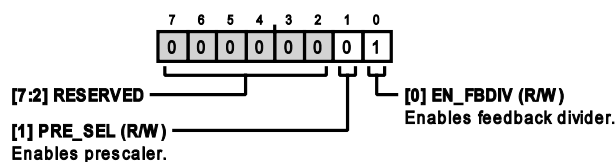

Table 17. Bit Descriptions for SYNTH

Bits	Bit Name	Description	Reset	Access
[7:2]	RESERVED	Reserved.	0x0	R
1	PRE_SEL	Enables prescaler. 0: disable. 1: enable.	0x0	R/W
0	EN_FBDIV	Enables feedback divider. 0: disable. 1: enable.	0x1	R/W

## REGISTER DETAILS

## Reference Input Divider Register

Address: 0x20C, Reset: 0x01, Name: R\_DIV

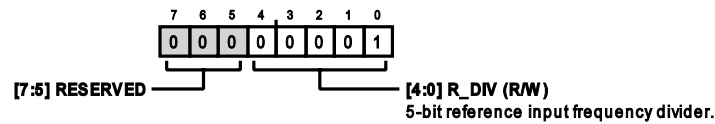

Table 18. Bit Descriptions for R\_DIV

Bits	Bit Name	Description	Reset	Access
[7:5]	RESERVED	Reserved.	0x0	R
[4:0]	R_DIV	5-bit reference input frequency divider.	0x1	R/W

## Reference Input Configuration Register

Address: 0x20E, Reset: 0x04, Name: REFERENCE

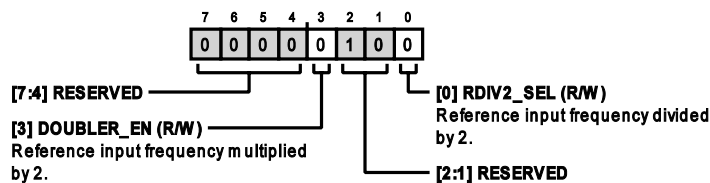

Table 19. Bit Descriptions for REFERENCE

Bits	Bit Name	Description	Reset	Access
[7:4]	RESERVED	Reserved.	0x0	R
3	DOUBLER_EN	Reference input frequency multiplied by 2. 0: disable. 1: enable.	0x0	R/W
[2:1]	RESERVED	Reserved.	0x2	R/W
0	RDIV2_SEL	Reference input frequency divided by 2. 0: disable. 1: enable.	0x0	R/W

## Lock Detect Configuration Register

Address: 0x214, Reset: 0x48, Name: LOCK\_DETECT\_CONFIG

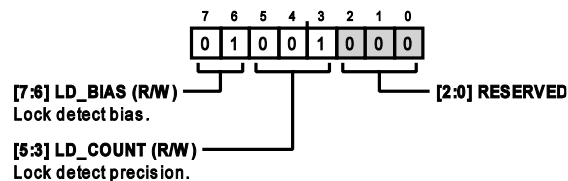

Table 20. Bit Descriptions for LOCK\_DETECT\_CONFIG

Bits	Bit Name	Description	Reset	Access
[7:6]	LD_BIAS	Lock detect bias. 00: 40 $\mu$ A. 01: 30 $\mu$ A.	0x1	R/W



## REGISTER DETAILS

Table 20. Bit Descriptions for LOCK\_DETECT\_CONFIG

Bits	Bit Name	Description	Reset	Access
[5:3]	LD_COUNT	10: 20 $\mu$ A. 11: 10 $\mu$ A.  Lock detect precision. 000: check 1024 consecutive PFD cycles for lock. 001: check 2048 consecutive PFD cycles for lock. 010: check 4096 consecutive PFD cycles for lock. 011: check 8192 consecutive PFD cycles for lock.	0x1	R/W
[2:0]	RESERVED	Reserved.	0x0	R/W

## Synthesizer Lock Timeout Register

Address: 0x218, Reset: 0x1F, Name: SYNTH\_LOCK\_TIMEOUT

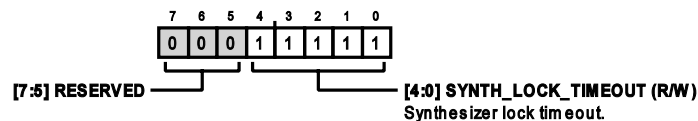

Table 21. Bit Descriptions for SYNTH\_LOCK\_TIMEOUT

Bits	Bit Name	Description	Reset	Access
[7:5]	RESERVED	Reserved.	0x0	R
[4:0]	SYNTH_LOCK_TIMEOUT	Synthesizer lock timeout.	0x1F	R/W

## VCO Timeout Register (Lower Eight Bits)

Address: 0x21C, Reset: 0x19, Name: VCO\_TIMEOUT\_L

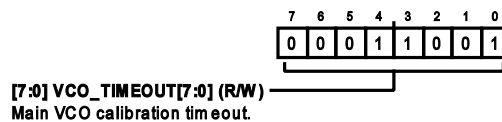

Table 22. Bit Descriptions for VCO\_TIMEOUT\_L

Bits	Bit Name	Description	Reset	Access
[7:0]	VCO_TIMEOUT[7:0]	Main VCO calibration timeout.	0x19	R/W

## VCO Timeout Register (Upper Eight Bits)

Address: 0x21D, Reset: 0x00, Name: VCO\_TIMEOUT\_H

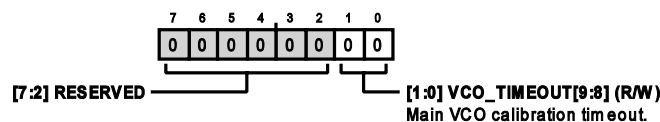

Table 23. Bit Descriptions for VCO\_TIMEOUT\_H

Bits	Bit Name	Description	Reset	Access
[7:2]	RESERVED	Reserved.	0x0	R
[1:0]	VCO_TIMEOUT[9:8]	Main VCO calibration timeout.	0x0	R/W

## REGISTER DETAILS

## VCO Band Divider Register

Address: 0x21E, Reset: 0x10, Name: VCO\_BAND\_DIV

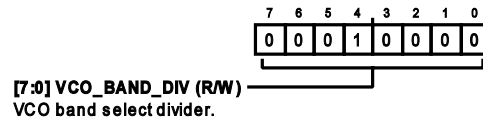

Table 24. Bit Descriptions for VCO\_BAND\_DIV

Bits	Bit Name	Description	Reset	Access
[7:0]	VCO_BAND_DIV	VCO band select divider.	0x10	R/W

## Multifunction Synthesizer Configuration Register

Address: 0x22B, Reset: 0x09, Name: MULTI\_FUNC\_SYNTH\_CTRL\_022B

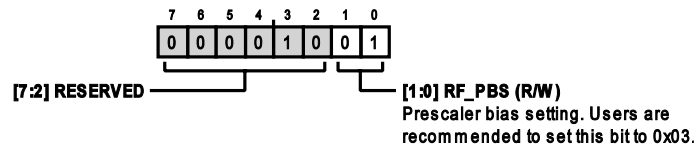

Table 25. Bit Descriptions for MULTI\_FUNC\_SYNTH\_CTRL\_022B

Bits	Bit Name	Description	Reset	Access
[7:2]	RESERVED	Reserved.	0x2	R
[1:0]	RF_PBS	Prescaler bias setting. Users are recommended to set this bit to 0x03.	0x1	R/W

## Charge Pump Current Register

Address: 0x22E, Reset: 0x0E, Name: CP\_CURR

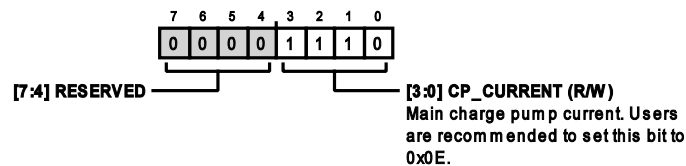

Table 26. Bit Descriptions for CP\_CURR

Bits	Bit Name	Description	Reset	Access
[7:4]	RESERVED	Reserved.	0x0	R
[3:0]	CP_CURRENT	Main charge pump current. Users are recommended to set this bit to 0x0E.	0xE	R/W

## Bleed Current Register

Address: 0x22F, Reset: 0x08, Name: BICP

REGISTER DETAILS

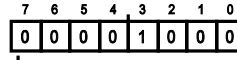

**[7:0] BICP (R/W)**  
Binary scaled bleed current. Users are recommended to set this bit to 0x27.

Table 27. Bit Descriptions for BICP

Bits	Bit Name	Description	Reset	Access
[7:0]	BICP	Binary scaled bleed current. Users are recommended to set this bit to 0x27.	0x8	R/W

Lock Detect Register

Address: 0x24D, Reset: 0x00, Name: LOCK\_DETECT

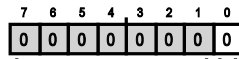

**[7:1] RESERVED**  
**[0] LOCK\_DETECT (R)**  
Lock detect.

Table 28. Bit Descriptions for LOCK\_DETECT

Bits	Bit Name	Description	Reset	Access
[7:1]	RESERVED	Reserved.	0x0	R
0	LOCK_DETECT	Lock detect. 1: PLL locks. 0: PLL does not lock.	0x0	R

MUXOUT Select Register

Address: 0x24E, Reset: 0x00, Name: MUXOUT

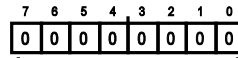

**[7:0] MUX\_SEL (R/W)**  
Select mux signal.

Table 29. Bit Descriptions for MUXOUT

Bits	Bit Name	Description	Reset	Access
[7:0]	MUX_SEL	Select mux signal. 0001: digital lock detect. 0000: output low. 0100: R counter/2. 0101: N counter/2. 1110: output high.	0x0	R/W

DSA Control Register

Address: 0x300, Reset: 0x00, Name: DSA\_CONTROL

REGISTER DETAILS

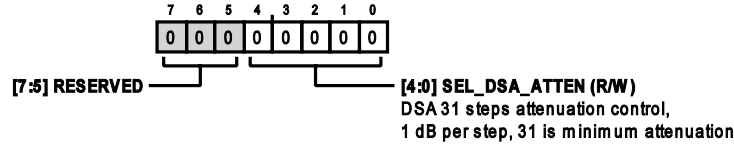

Table 30. Bit Descriptions for DSA\_CONTROL

Bits	Bit Name	Description	Reset	Access
[7:5]	RESERVED	Reserved.	0x0	R
[4:0]	SEL_DSA_ATTEN	DSA 31 steps attenuation control, 1 dB per step, 31 dB is minimum attenuation	0x0	R/W

AGPIO Control Register

Address: 0x301, Reset: 0x00, Name: AGPIO\_CONTROL

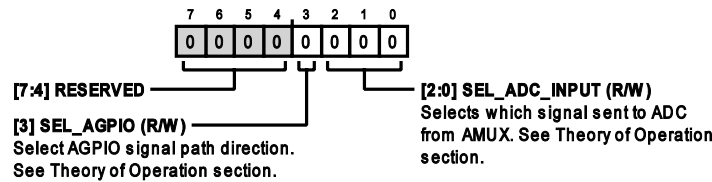

Table 31. Bit Descriptions for AGPIO\_CONTROL

Bits	Bit Name	Description	Reset	Access
[7:4]	RESERVED	Reserved.	0x0	R
3	SEL_AGPIO	Select AGPIO signal path direction. See the Theory of Operation section. 0: analog mux output to AGPIO. AGPIO is output. 1: AGPIO signal sent to analog mux. AGPIO is external signal input.	0x0	R/W
[2:0]	SEL_ADC_INPUT	Selects which signal sent to ADC from analog mux. See the Theory of Operation section. 110: temperature sensor. 111: AGPIO, must also set SEL_AGPIO to 1.	0x0	R/W

ADC Control Register

Address: 0x302, Reset: 0xCA, Name: ADC\_CONTROL

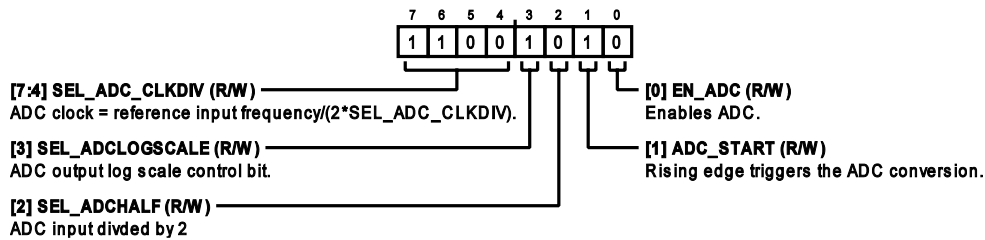

Table 32. Bit Descriptions for ADC\_CONTROL

Bits	Bit Name	Description	Reset	Access
[7:4]	SEL_ADC_CLKDIV	ADC clock = reference input frequency/(2 * SEL_ADC_CLKDIV).	0xC	R/W
3	SEL_ADCLOGSCALE	ADC output log scale control bit. 1: enable. 0: disable.	0x1	R/W

## REGISTER DETAILS

Table 32. Bit Descriptions for ADC\_CONTROL

Bits	Bit Name	Description	Reset	Access
2	SEL_ADCHALF	ADC input divided by 2. 1: enable. 0: disable.	0x0	R/W
1	ADC_START	Rising edge triggers the ADC conversion.	0x1	R/W
0	EN_ADC	Enables ADC. 1: enable. 0: disable.	0x0	R/W

## ADC Status Register

Address: 0x303, Reset: 0x01, Name: ADC\_STATUS

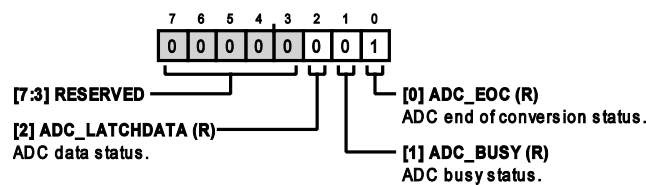

Table 33. Bit Descriptions for ADC\_STATUS

Bits	Bit Name	Description	Reset	Access
[7:3]	RESERVED	Reserved.	0x0	R
2	ADC_LATCHDATA	ADC data status. 1: ready. 0: not ready.	0x0	R
1	ADC_BUSY	ADC busy status. 1: busy. 0: not busy.	0x0	R
0	ADC_EOC	ADC end of conversion status. 1: complete. 0: not complete.	0x1	R

## ADC Data Register

Address: 0x304, Reset: 0xE1, Name: ADC\_DATA

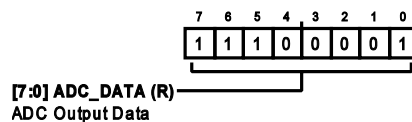

Table 34. Bit Descriptions for ADC\_DATA

Bits	Bit Name	Description	Reset	Access
[7:0]	ADC_DATA	ADC output data.	0xE1	R

## GPIO Write Register

Address: 0x305, Reset: 0x00, Name: GPIO\_WRITEVALS

## REGISTER DETAILS

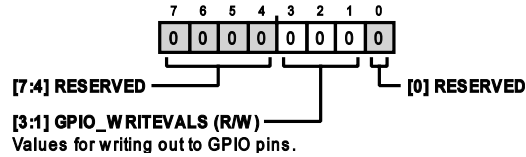

Table 35. Bit Descriptions for GPIO\_WRITEVALS

Bits	Bit Name	Description	Reset	Access
[7:4]	RESERVED	Reserved.	0x0	R
[3:1]	GPIO_WRITEVALS	Values for writing out to GPIO pins.	0x0	R/W
0	RESERVED	Reserved.	0x0	R

## GPIO Read Register

Address: 0x306, Reset: 0x0E, Name: GPIO\_READVALS

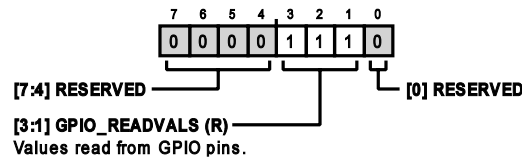

Table 36. Bit Descriptions for GPIO\_READVALS

Bits	Bit Name	Description	Reset	Access
[7:4]	RESERVED	Reserved.	0x0	R
[3:1]	GPIO_READVALS	Values read from GPIO pins.	0x7	R
0	RESERVED	Reserved.	0x0	R

## GPIO Control Register

Address: 0x307, Reset: 0x00, Name: GPIO\_CONTROL

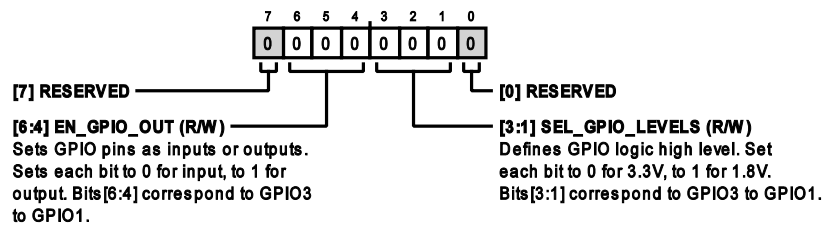

Table 37. Bit Descriptions for GPIO\_CONTROL

Bits	Bit Name	Description	Reset	Access
7	RESERVED	Reserved.	0x0	R
[6:4]	EN_GPIO_OUT	Sets GPIO pins as inputs or outputs. Sets each bit to 0 for input, or to 1 for output. Bits[6:4] correspond to GPIO3 to GPIO1.	0x0	R/W
[3:1]	SEL_GPIO_LEVELS	Defines GPIO logic high level. Set each bit to 0 for 3.3 V, or to 1 for 1.8 V. Bits[3:1] correspond to GPIO3 to GPIO1.	0x0	R/W
0	RESERVED	Reserved.	0x0	R

## REGISTER DETAILS

## RF Bias Control 1 Register

Address: 0x308, Reset: 0x08, Name: RFBIAS\_CONTROL1

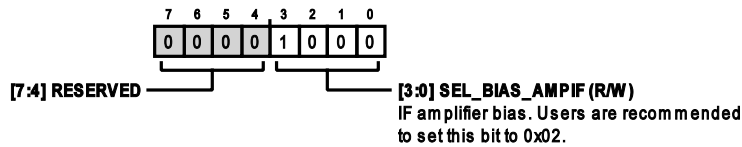

Table 38. Bit Descriptions for RFBIAS\_CONTROL1

Bits	Bit Name	Description	Reset	Access
[7:4]	RESERVED	Reserved.	0x0	R
[3:0]	SEL_BIAS_AMPIF	IF amplifier bias. Users are recommended to set this bit to 0x02.	0x8	R/W

## RF Bias Control 2 Register

Address: 0x309, Reset: 0x88, Name: RFBIAS\_CONTROL2

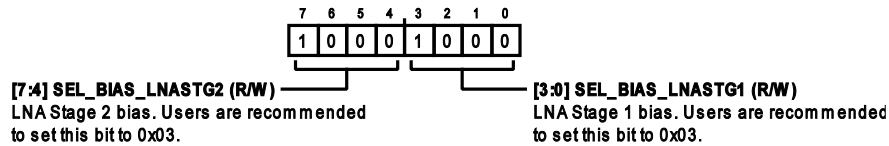

Table 39. Bit Descriptions for RFBIAS\_CONTROL2

Bits	Bit Name	Description	Reset	Access
[7:4]	SEL_BIAS_LNASTG2	LNA Stage 2 bias. Users are recommended to set this bit to 0x03.	0x8	R/W
[3:0]	SEL_BIAS_LNASTG1	LNA Stage 1 bias. Users are recommended to set this bit to 0x03.	0x8	R/W

## RF Bias Control 3 Register

Address: 0x30A, Reset: 0x88, Name: RFBIAS\_CONTROL3

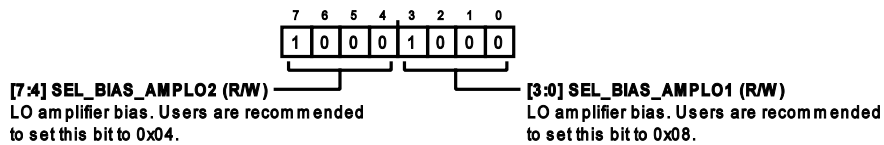
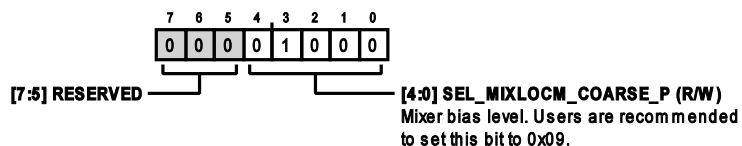

Table 40. Bit Descriptions for RFBIAS\_CONTROL3

Bits	Bit Name	Description	Reset	Access
[7:4]	SEL_BIAS_AMPLO2	LO amplifier bias. Users are recommended to set this bit to 0x04.	0x8	R/W
[3:0]	SEL_BIAS_AMPLO1	LO amplifier bias. Users are recommended to set this bit to 0x08.	0x8	R/W

## Mixer Bias Control 1 Register

Address: 0x30D, Reset: 0x08, Name: MIXER\_CONTROL1



## REGISTER DETAILS

Table 41. Bit Descriptions for MIXER\_CONTROL1

Bits	Bit Name	Description	Reset	Access
[7:5]	RESERVED	Reserved.	0x0	R
[4:0]	SEL_MIXLOCM_COARSE_P	Mixer bias level. Users are recommended to set this bit to 0x09.	0x8	R/W

## Mixer Bias Control 2 Register

Address: 0x30E, Reset: 0x08, Name: MIXER\_CONTROL2

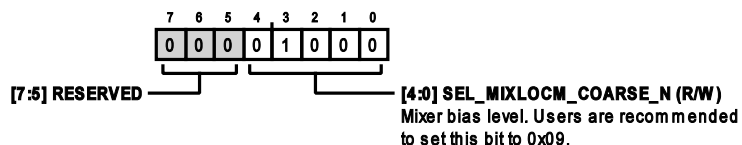
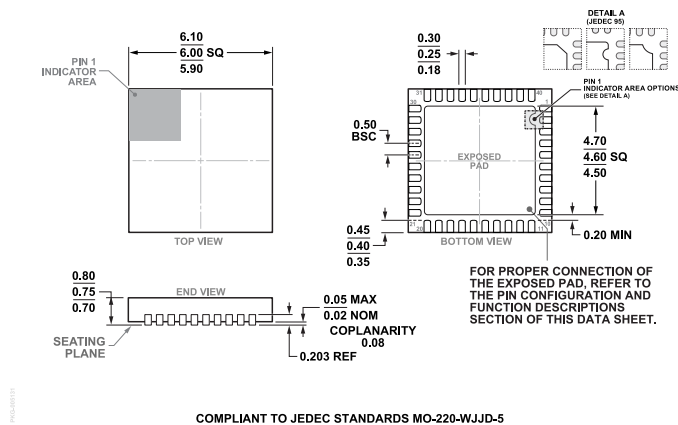

Table 42. Bit Descriptions for MIXER\_CONTROL2

Bits	Bit Name	Description	Reset	Access
[7:5]	RESERVED	Reserved.	0x0	R
[4:0]	SEL_MIXLOCM_COARSE_N	Mixer bias level. Users are recommended to set this bit to 0x09.	0x8	R/W



OUTLINE DIMENSIONS



**Figure 76. 40-Lead Lead Frame Chip Scale Package [LFCSP]  
6 mm x 6 mm Body and 0.75 mm Package Height  
(CP-40-7)  
Dimensions shown in millimeters**

Updated: June 16, 2022

ORDERING GUIDE

Model <sup>1</sup>	Temperature Range	Package Description	Packing Quantity	Package Option
ADMV4640BCPZN	-40°C to +85°C	40-Lead LFCSP (6mm x 6mm w/ EP)	Reel, 50	CP-40-7
ADMV4640BCPZN-RL7	-40°C to +85°C	40-Lead LFCSP (6mm x 6mm w/ EP)	Reel, 750	CP-40-7

<sup>1</sup> Z = RoHS Compliant Part.

EVALUATION BOARDS

Model <sup>1</sup>	Description
EVAL-ADMV4640Z	Evaluation Assembly Board

<sup>1</sup> Z = RoHS Compliant Part.