

AN-1550 LM2831X 6-Pin WSON Demo Board

1 Introduction

This demo board converts 3V to 5.5V input to 1.8V output for 1.5A load current using the LM2831X 1.6 MHz DC-DC switching converter. This is a 4-layer board using the internal layers as a VIN plane and Ground plane.

A bill of materials ([Section 6](#)) describes the parts used on this demo board. A schematic and layout have also been included, along with measured performance characteristics. The above restrictions for the input voltage are valid only for the demo board as shipped with the demo board schematic shown in [Figure 1](#).

Operating Conditions

- $V_{IN} = 3V$ to $5.5V$
- $V_O = 1.8V$
- $I_o = 1.5A$

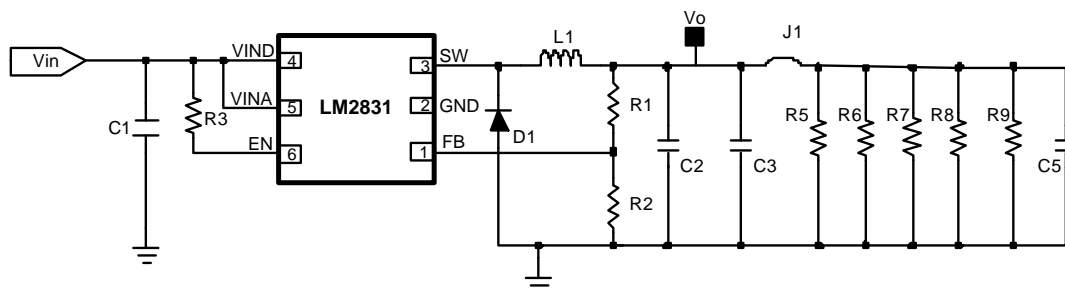
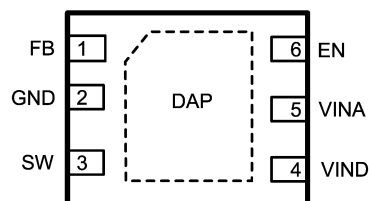

Figure 1. LM2831X 6-Pin WSON Demo Board Schematic

2 Pin-Out



3 Pin Description

Pin	Name	Function
1	FB	Feedback pin. Connect to external resistor divider to set output voltage.
2	GND	Signal and power ground pin. Place the bottom resistor of the feedback network as close as possible to this pin.
3	SW	Output switch. Connect to the inductor and catch diode.
4	VIND	Power Input supply.
5	VINA	Control circuitry supply voltage. Connect VINA to VIND on PC board.
6	EN	Enable control input. Logic high enables operation. Do not allow this pin to float or be greater than $V_{INA} + 0.3V$.
DAP	Die Attach Pad	Connect to system ground for low thermal impedance, but it cannot be used as a primary GND connection.

4 LM2831 Gain/Phase 5V to 1.8V @ 1A

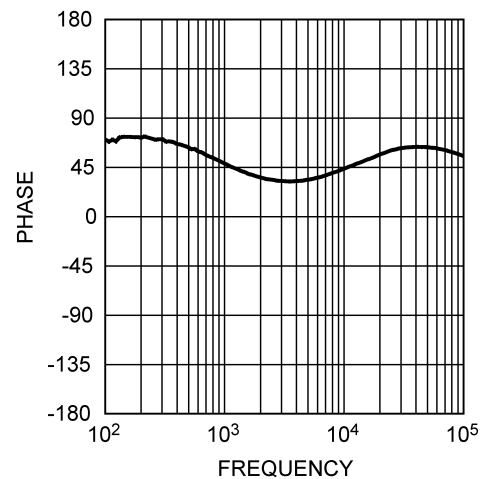
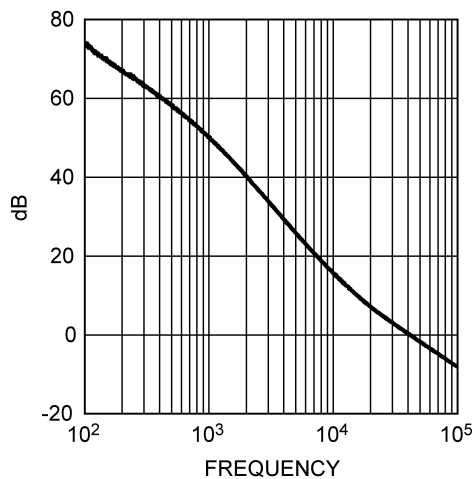

5 LM2831 Efficiency: $V_{in} = 3.3V$, $V_o = 1.8V$

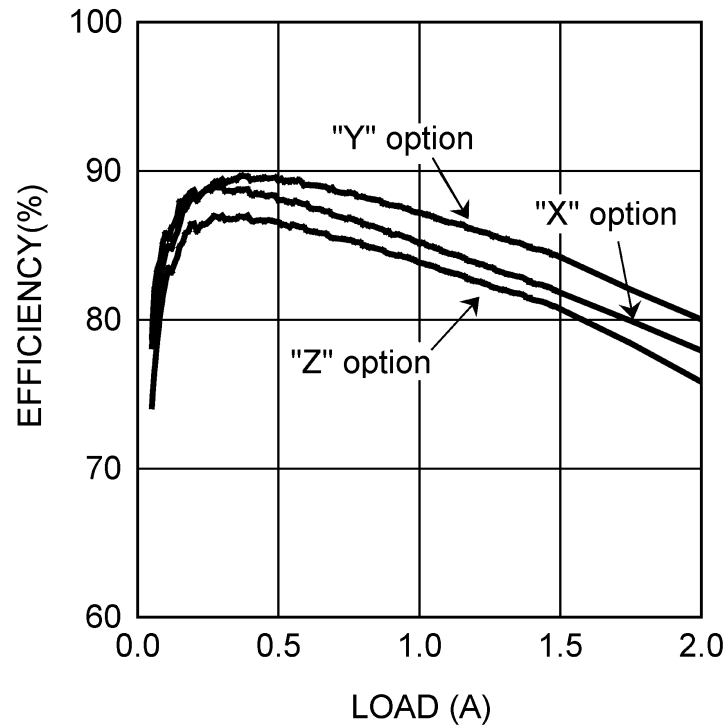

6 Bill of Materials LM2831X-Version

Part ID	Part Value	Manufacturer	Part Number
U1	1.5A Buck Regulator	Texas Instruments	LM2831
C1, Input Cap	22 μ F, 6.3V, X5R	TDK	C3216X5ROJ226M
C2 Output Cap	22 μ F, 6.3V, X5R	TDK	C3216X5ROJ226M
C3 Output Cap	22 μ F, 6.3V, X5R	TDK	C3216X5ROJ226M
D1, Catch Diode	0.3V _F Schottky 1.5A, 30V _R	TOSHIBA	CRS08
L1	3.3 μ H, 3.5A	CoilCraft	MSS7341-332NL
R1	20.0 k Ω , 1%	Vishay	CRCW08052002F
R2	10.0 k Ω , 1%	Vishay	CRCW08051002F
R3	20.0 k Ω , 1%	Vishay	CRCW08052002F
J1	No Load		
R5 – R9	No Load		

7 Layout

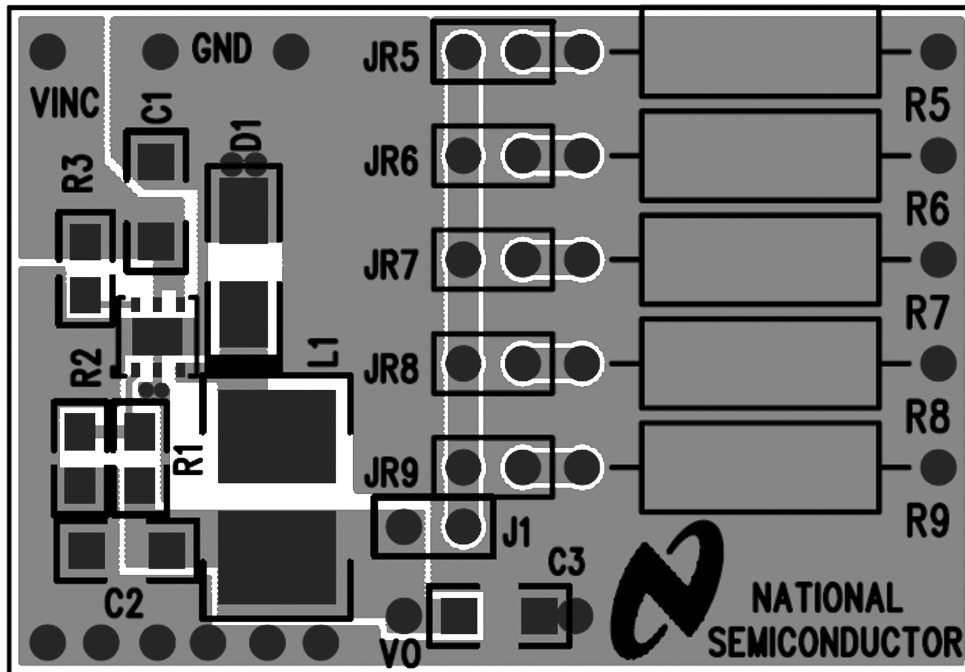

Figure 2. Top Layer

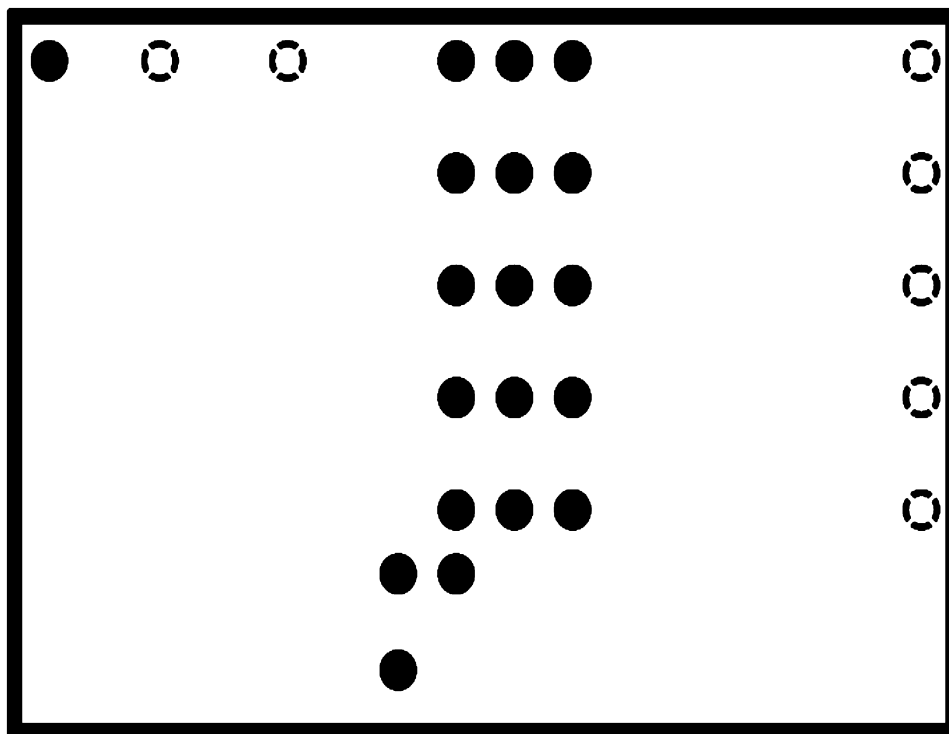

Figure 3. Internal Plane 1 (GND)

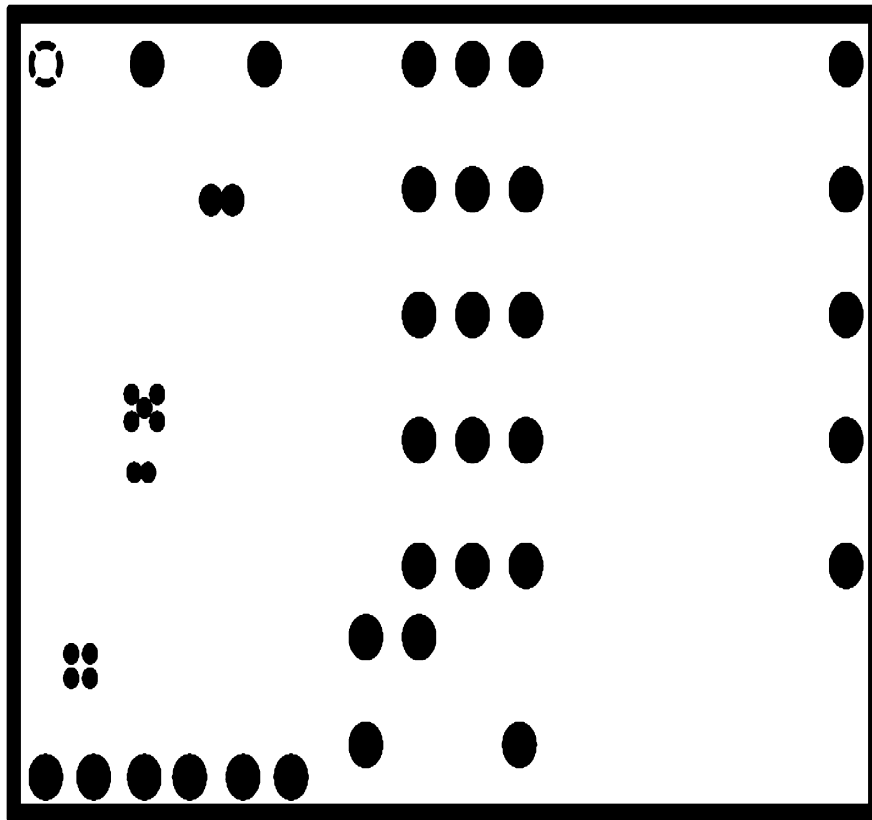

Figure 4. Internal Plane 2 (V_{IN})

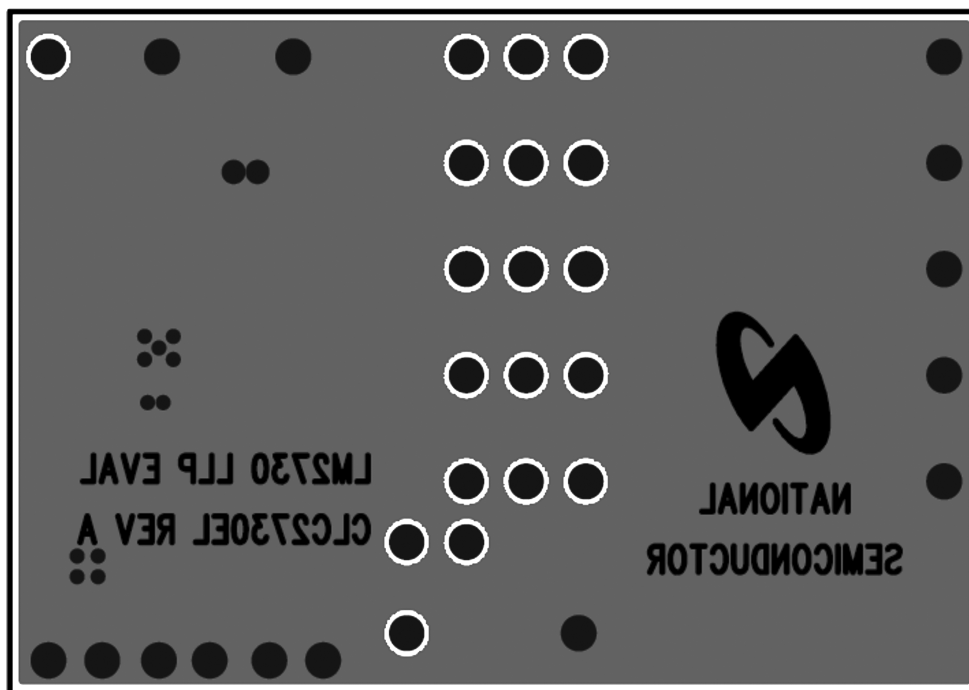

Figure 5. Bottom Layer

IMPORTANT NOTICE

Texas Instruments Incorporated and its subsidiaries (TI) reserve the right to make corrections, enhancements, improvements and other changes to its semiconductor products and services per JESD46, latest issue, and to discontinue any product or service per JESD48, latest issue. Buyers should obtain the latest relevant information before placing orders and should verify that such information is current and complete. All semiconductor products (also referred to herein as "components") are sold subject to TI's terms and conditions of sale supplied at the time of order acknowledgment.

TI warrants performance of its components to the specifications applicable at the time of sale, in accordance with the warranty in TI's terms and conditions of sale of semiconductor products. Testing and other quality control techniques are used to the extent TI deems necessary to support this warranty. Except where mandated by applicable law, testing of all parameters of each component is not necessarily performed.

TI assumes no liability for applications assistance or the design of Buyers' products. Buyers are responsible for their products and applications using TI components. To minimize the risks associated with Buyers' products and applications, Buyers should provide adequate design and operating safeguards.

TI does not warrant or represent that any license, either express or implied, is granted under any patent right, copyright, mask work right, or other intellectual property right relating to any combination, machine, or process in which TI components or services are used. Information published by TI regarding third-party products or services does not constitute a license to use such products or services or a warranty or endorsement thereof. Use of such information may require a license from a third party under the patents or other intellectual property of the third party, or a license from TI under the patents or other intellectual property of TI.

Reproduction of significant portions of TI information in TI data books or data sheets is permissible only if reproduction is without alteration and is accompanied by all associated warranties, conditions, limitations, and notices. TI is not responsible or liable for such altered documentation. Information of third parties may be subject to additional restrictions.

Resale of TI components or services with statements different from or beyond the parameters stated by TI for that component or service voids all express and any implied warranties for the associated TI component or service and is an unfair and deceptive business practice. TI is not responsible or liable for any such statements.

Buyer acknowledges and agrees that it is solely responsible for compliance with all legal, regulatory and safety-related requirements concerning its products, and any use of TI components in its applications, notwithstanding any applications-related information or support that may be provided by TI. Buyer represents and agrees that it has all the necessary expertise to create and implement safeguards which anticipate dangerous consequences of failures, monitor failures and their consequences, lessen the likelihood of failures that might cause harm and take appropriate remedial actions. Buyer will fully indemnify TI and its representatives against any damages arising out of the use of any TI components in safety-critical applications.

In some cases, TI components may be promoted specifically to facilitate safety-related applications. With such components, TI's goal is to help enable customers to design and create their own end-product solutions that meet applicable functional safety standards and requirements. Nonetheless, such components are subject to these terms.

No TI components are authorized for use in FDA Class III (or similar life-critical medical equipment) unless authorized officers of the parties have executed a special agreement specifically governing such use.

Only those TI components which TI has specifically designated as military grade or "enhanced plastic" are designed and intended for use in military/aerospace applications or environments. Buyer acknowledges and agrees that any military or aerospace use of TI components which have **not** been so designated is solely at the Buyer's risk, and that Buyer is solely responsible for compliance with all legal and regulatory requirements in connection with such use.

TI has specifically designated certain components as meeting ISO/TS16949 requirements, mainly for automotive use. In any case of use of non-designated products, TI will not be responsible for any failure to meet ISO/TS16949.

Products

Audio	www.ti.com/audio
Amplifiers	amplifier.ti.com
Data Converters	dataconverter.ti.com
DLP® Products	www.dlp.com
DSP	dsp.ti.com
Clocks and Timers	www.ti.com/clocks
Interface	interface.ti.com
Logic	logic.ti.com
Power Mgmt	power.ti.com
Microcontrollers	microcontroller.ti.com
RFID	www.ti-rfid.com
OMAP Applications Processors	www.ti.com/omap
Wireless Connectivity	www.ti.com/wirelessconnectivity

Applications

Automotive and Transportation	www.ti.com/automotive
Communications and Telecom	www.ti.com/communications
Computers and Peripherals	www.ti.com/computers
Consumer Electronics	www.ti.com/consumer-apps
Energy and Lighting	www.ti.com/energy
Industrial	www.ti.com/industrial
Medical	www.ti.com/medical
Security	www.ti.com/security
Space, Avionics and Defense	www.ti.com/space-avionics-defense
Video and Imaging	www.ti.com/video

TI E2E Community

e2e.ti.com