

# TrenchMV™ Power MOSFET

## IXTA152N085T IXTP152N085T

$$V_{DSS} = 85 \text{ V}$$

$$I_{D25} = 152 \text{ A}$$

$$R_{DS(on)} \leq 7.0 \text{ m}\Omega$$

N-Channel Enhancement Mode  
Avalanche Rated

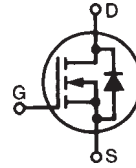

Symbol	Test Conditions	Maximum Ratings	
$V_{DSS}$	$T_J = 25^\circ\text{C}$ to $175^\circ\text{C}$	85	V
$V_{DGR}$	$T_J = 25^\circ\text{C}$ to $175^\circ\text{C}$ ; $R_{GS} = 1 \text{ M}\Omega$	85	V
$V_{GSM}$	Transient	$\pm 20$	V
$I_{D25}$	$T_C = 25^\circ\text{C}$	152	A
$I_{LRMS}$	Lead Current Limit, RMS	75	A
$I_{DM}$	$T_C = 25^\circ\text{C}$ , pulse width limited by $T_{JM}$	410	A
$I_{AR}$	$T_C = 25^\circ\text{C}$	25	A
$E_{AS}$	$T_C = 25^\circ\text{C}$	750	mJ
$dv/dt$	$I_S \leq I_{DM}$ , $di/dt \leq 100 \text{ A}/\mu\text{s}$ , $V_{DD} \leq V_{DSS}$ $T_J \leq 175^\circ\text{C}$ , $R_G = 5 \Omega$	3	V/ns
$P_D$	$T_C = 25^\circ\text{C}$	360	W
$T_J$		-55 ... +175	$^\circ\text{C}$
$T_{JM}$		175	$^\circ\text{C}$
$T_{stg}$		-55 ... +175	$^\circ\text{C}$
$T_L$	1.6 mm (0.062 in.) from case for 10 s	300	$^\circ\text{C}$
$T_{SOLD}$	Plastic body for 10 seconds	260	$^\circ\text{C}$
$M_d$	Mounting torque (TO-220)	1.13 / 10	Nm/lb.in.
Weight	TO-220	3	g
	TO-263	2.5	g

TO-263 (IXTA)

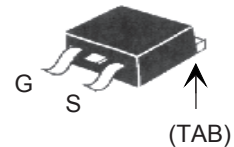

TO-220 (IXTP)



G = Gate      D = Drain  
S = Source      TAB = Drain

### Features

- Ultra-low On Resistance
- Unclamped Inductive Switching (UIS) rated
- Low package inductance
  - easy to drive and to protect
- 175  $^\circ\text{C}$  Operating Temperature

### Advantages

- Easy to mount
- Space savings
- High power density

### Applications

- Automotive
  - Motor Drives
  - 42V Power Bus
  - ABS Systems
- DC/DC Converters and Off-line UPS
- Primary Switch for 24V and 48V Systems
- High Current Switching Applications

Symbol	Test Conditions ( $T_J = 25^\circ\text{C}$ unless otherwise specified)	Characteristic Values		
		Min.	Typ.	Max.
$BV_{DSS}$	$V_{GS} = 0 \text{ V}$ , $I_D = 250 \mu\text{A}$	85		V
$V_{GS(th)}$	$V_{DS} = V_{GS}$ , $I_D = 250 \mu\text{A}$	2.0		V
$I_{GSS}$	$V_{GS} = \pm 20 \text{ V}$ , $V_{DS} = 0 \text{ V}$			$\pm 200 \text{ nA}$
$I_{DSS}$	$V_{DS} = V_{DSS}$			25 $\mu\text{A}$
	$V_{GS} = 0 \text{ V}$ $T_J = 150^\circ\text{C}$			250 $\mu\text{A}$
$R_{DS(on)}$	$V_{GS} = 10 \text{ V}$ , $I_D = 25 \text{ A}$ , Notes 1, 2	5.8	7.0	m $\Omega$

Symbol	Test Conditions	Characteristic Values		
		Min.	Typ.	Max.
$(T_J = 25^\circ\text{C unless otherwise specified})$				
$g_{fs}$	$V_{DS} = 10\text{ V}; I_D = 60\text{ A, Note 1}$	60	100	S
$C_{iss}$			5500	pF
$C_{oss}$	$V_{GS} = 0\text{ V}, V_{DS} = 25\text{ V}, f = 1\text{ MHz}$		720	pF
$C_{rss}$			150	pF
$t_{d(on)}$	<b>Resistive Switching Times</b>		30	ns
$t_r$	$V_{GS} = 10\text{ V}, V_{DS} = 0.5 V_{DSS}, I_D = 25\text{ A}$		50	ns
$t_{d(off)}$	$R_G = 5\ \Omega$ (External)		50	ns
$t_f$			45	ns
$Q_{g(on)}$			114	nC
$Q_{gs}$	$V_{GS} = 10\text{ V}, V_{DS} = 0.5 V_{DSS}, I_D = 25\text{ A}$		30	nC
$Q_{gd}$			35	nC
$R_{thJC}$				$0.42^\circ\text{C/W}$
$R_{thCH}$	TO-220	0.50		$^\circ\text{C/W}$

### Source-Drain Diode

Symbol	Test Conditions	Characteristic Values		
		Min.	Typ.	Max.
$(T_J = 25^\circ\text{C unless otherwise specified})$				
$I_S$	$V_{GS} = 0\text{ V}$			152 A
$I_{SM}$	Pulse width limited by $T_{JM}$			410 A
$V_{SD}$	$I_F = 25\text{ A}, V_{GS} = 0\text{ V, Note 1}$			1.0 V
$t_{rr}$	$I_F = 25\text{ A}, -di/dt = 100\text{ A}/\mu\text{s}$ $V_R = 40\text{ V}, V_{GS} = 0\text{ V}$		90	ns

- Notes: 1. Pulse test,  $t \leq 300\ \mu\text{s}$ , duty cycle  $d \leq 2\%$ ;  
2. On through-hole packages,  $R_{DS(on)}$  Kelvin test contact location must be 5 mm or less from the package body.

### PRELIMINARY TECHNICAL INFORMATION

The product presented herein is under development. The Technical Specifications offered are derived from data gathered during objective characterizations of preliminary engineering lots; but also may yet contain some information supplied during a pre-production design evaluation. IXYS reserves the right to change limits, test conditions, and dimensions without notice.

IXYS reserves the right to change limits, test conditions, and dimensions.

### TO-263AA (IXTA) Outline

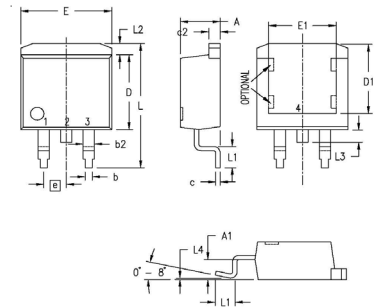

Pins: 1 - Gate 2 - Drain  
3 - Source 4, TAB - Drain

Dim.	Millimeter		Inches	
	Min.	Max.	Min.	Max.
A	4.06	4.83	.160	.190
A1	2.03	2.79	.080	.110
b	0.51	0.99	.020	.039
b2	1.14	1.40	.045	.055
c	0.46	0.74	.018	.029
c2	1.14	1.40	.045	.055
D	8.64	9.65	.340	.380
D1	7.11	8.13	.280	.320
E	9.65	10.29	.380	.405
E1	6.86	8.13	.270	.320
e	2.54	BSC	.100	BSC
L	14.61	15.88	.575	.625
L1	2.29	2.79	.090	.110
L2	1.02	1.40	.040	.055
L3	1.27	1.78	.050	.070
L4	0	0.38	0	.015
R	0.46	0.74	.018	.029

### TO-220AB (IXTP) Outline

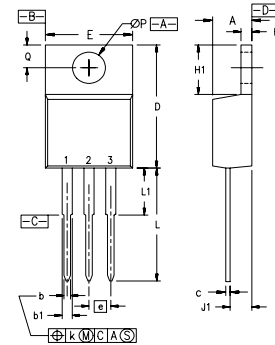

Pins: 1 - Gate 2 - Drain  
3 - Source 4, TAB - Drain

SYM	INCHES		MILLIMETERS	
	MIN	MAX	MIN	MAX
A	.170	.190	4.32	4.83
b	.025	.040	0.64	1.02
b1	.045	.065	1.15	1.65
c	.014	.022	0.35	0.56
D	.580	.630	14.73	16.00
E	.390	.420	9.91	10.66
e	.100	BSC	2.54	BSC
F	.045	.055	1.14	1.40
H1	.230	.270	5.85	6.85
J1	.090	.110	2.29	2.79
k	0	.015	0	0.38
L	.500	.550	12.70	13.97
L1	.110	.230	2.79	5.84
ØP	.139	.161	3.53	4.08
Q	.100	.125	2.54	3.18

**Fig. 1. Output Characteristics @ 25°C**

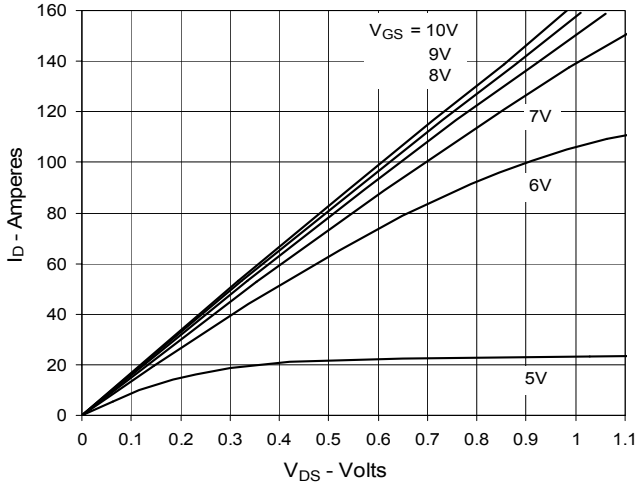

**Fig. 2. Extended Output Characteristics @ 25°C**

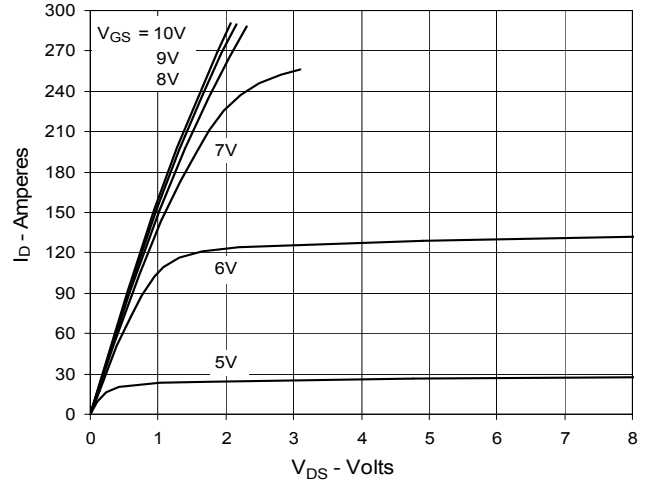

**Fig. 3. Output Characteristics @ 150°C**

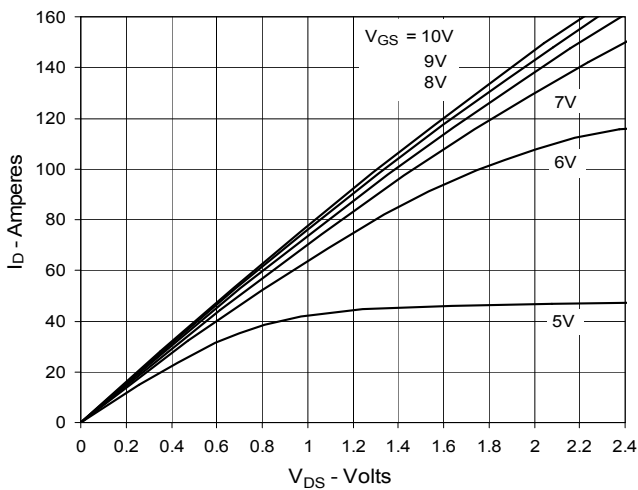

**Fig. 4.  $R_{DS(on)}$  Normalized to  $I_D = 76A$  Value vs. Junction Temperature**

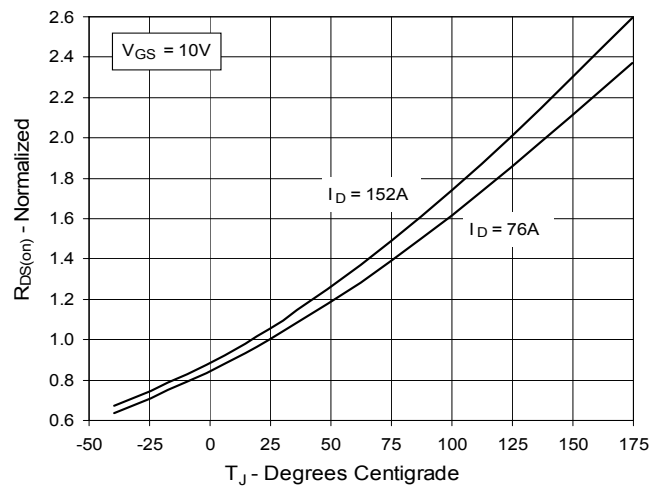

**Fig. 5.  $R_{DS(on)}$  Normalized to  $I_D = 76A$  Value vs. Drain Current**

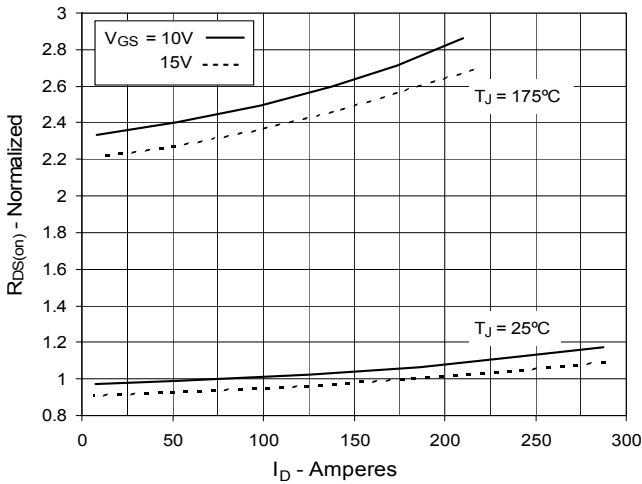

**Fig. 6. Drain Current vs. Case Temperature**

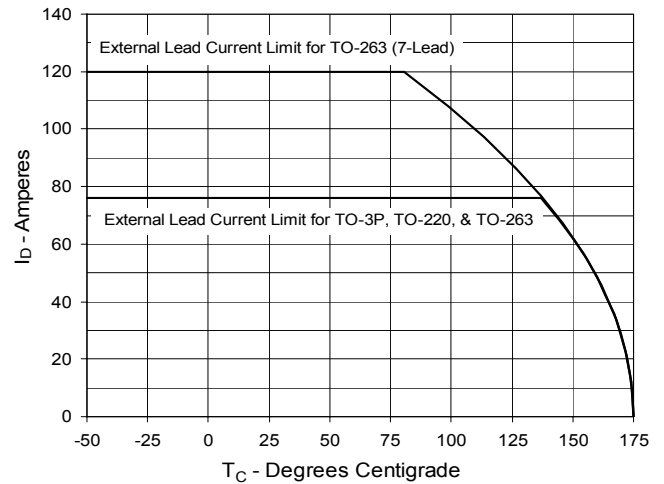

**Fig. 7. Input Admittance**

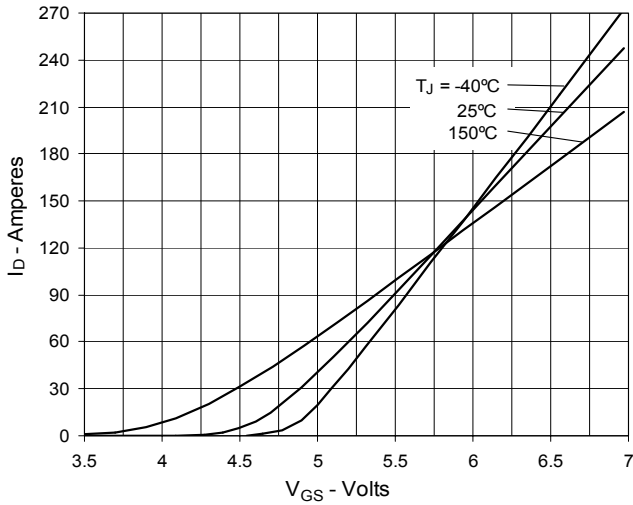

**Fig. 8. Transconductance**

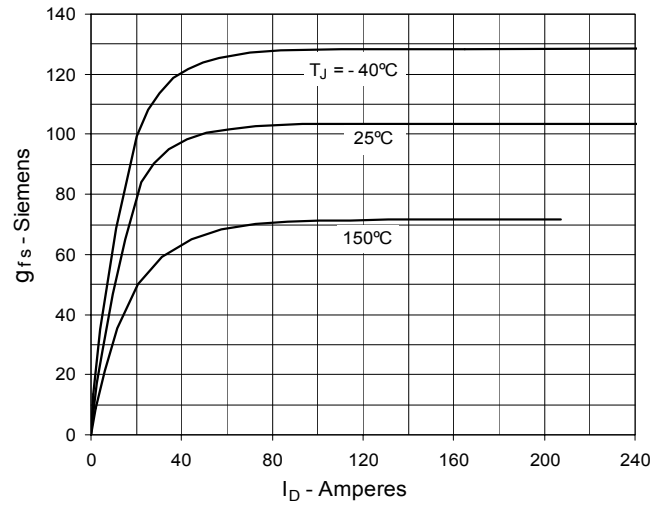

**Fig. 9. Forward Voltage Drop of Intrinsic Diode**

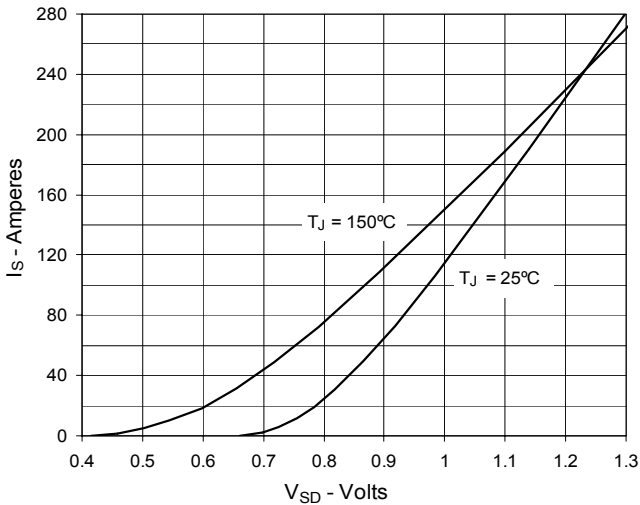

**Fig. 10. Gate Charge**

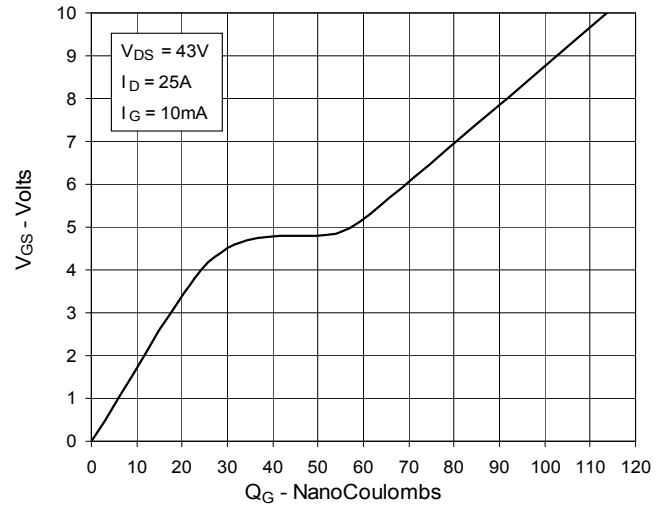

**Fig. 11. Capacitance**

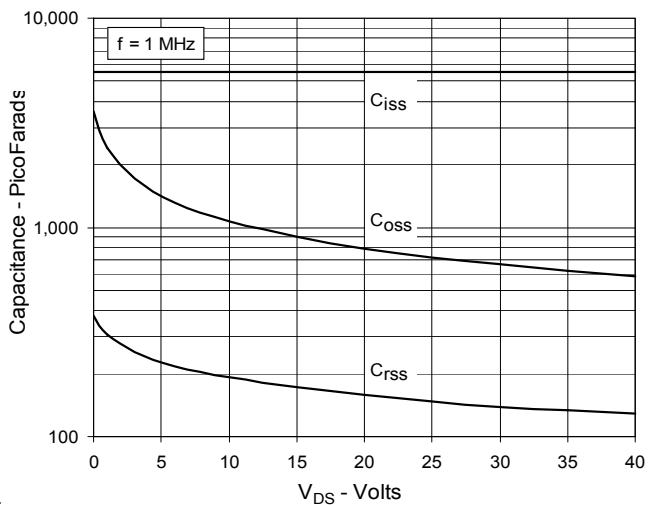

**Fig. 12. Maximum Transient Thermal Impedance**

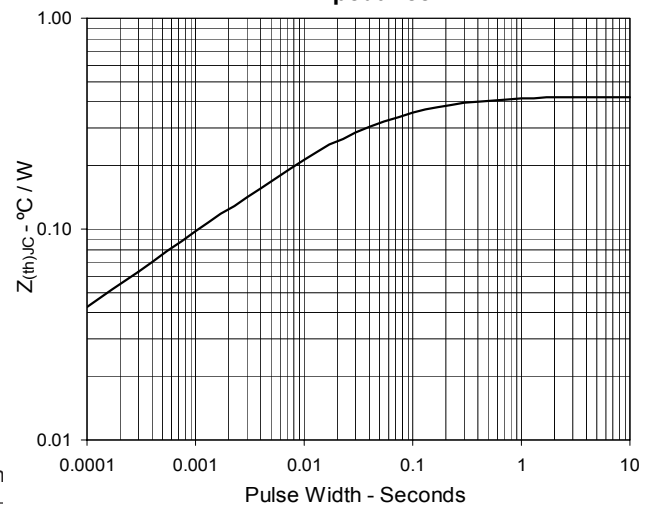

**Fig. 13. Resistive Turn-on  
Rise Time vs. Junction Temperature**

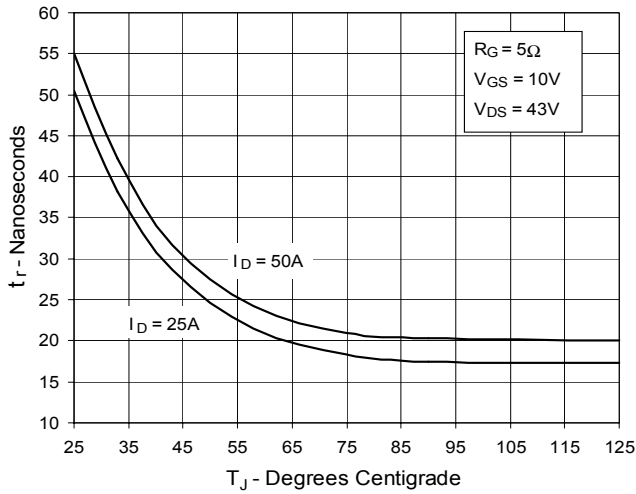

**Fig. 14. Resistive Turn-on  
Rise Time vs. Drain Current**

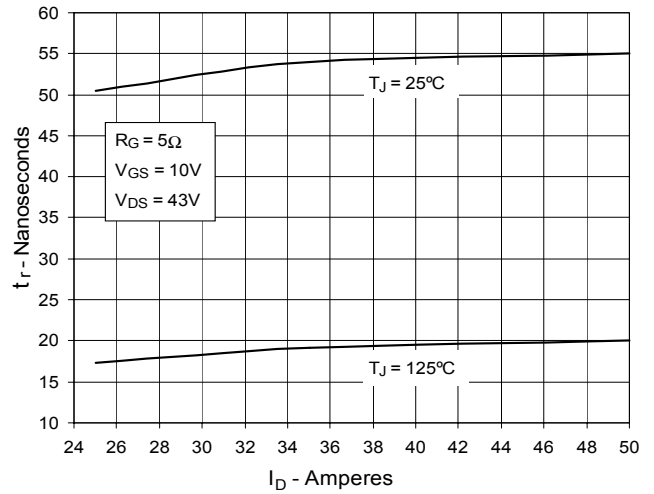

**Fig. 15. Resistive Turn-on  
Switching Times vs. Gate Resistance**

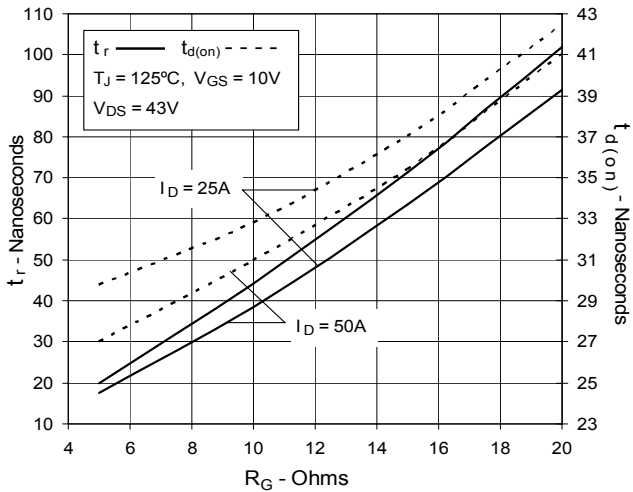

**Fig. 16. Resistive Turn-off  
Switching Times vs. Junction Temperature**

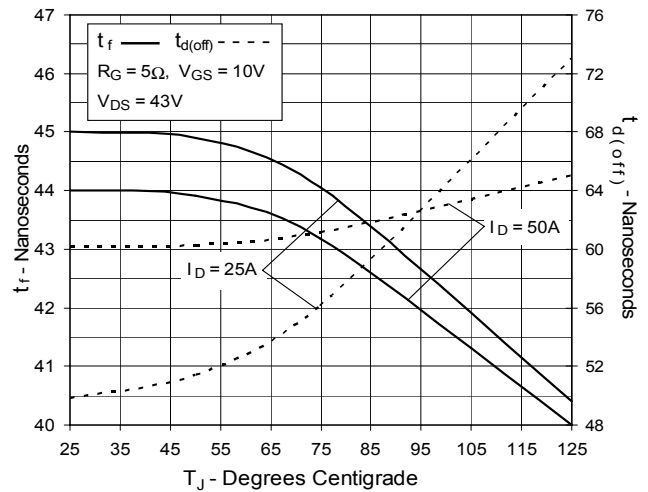

**Fig. 17. Resistive Turn-off  
Switching Times vs. Drain Current**

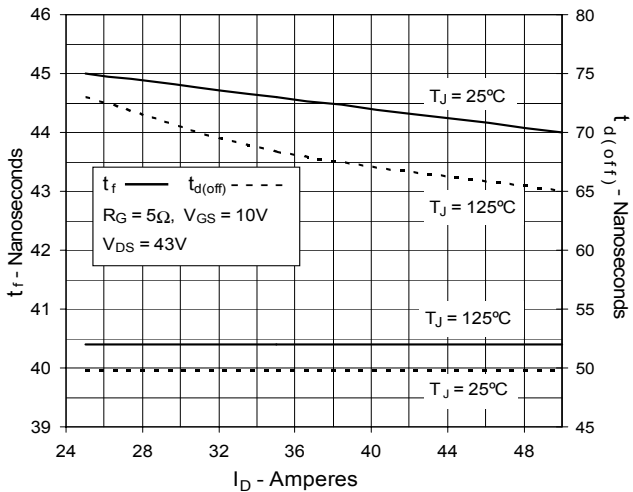

**Fig. 18. Resistive Turn-off  
Switching Times vs. Gate Resistance**

