

# MAX544X Evaluation Kit

## Evaluates: MAX5441–MAX5444

### General Description

The MAX544X evaluation kit (EV kit) provides a proven design to evaluate the MAX5441–MAX5442 serial-input, voltage-output, 16-bit digital-to-analog converters (DACs). The EV kit also includes Windows XP®, Windows Vista®, and Windows® 7-compatible software that provides a simple graphical user interface (GUI) for exercising the features of these devices.

The DACs are controlled by an on-board MAXQ® microcontroller, which provides two separate SPI control interfaces. The EV kit provides on-board +2.5V and +4.096V high-precision voltage references (MAX6126). The EV kit also provides precision bipolar and ultra-precision unipolar op amps, the MAX9632 (single) and MAX44251 (dual), respectively.

The EV kit comes with the +5V MAX5441AEUA+ and +5V MAX5442AEUB+ installed; however, it can also be used to evaluate other parts in the same family. Contact the factory for free samples of the pin-compatible devices shown in Table 1.

### Features

- ◆ Provides Both Bipolar and Unipolar Output
- ◆ On-Board +2.5V and +4.096V High-Precision Voltage References
- ◆ On-Board Bipolar and Unipolar High-Precision Op Amps
- ◆ Proven High-Performance 16-Bit DAC PCB Layout
- ◆ High-Speed USB 2.0 USB-PC Connection (Cable Included)
- ◆ Windows XP-, Windows Vista-, and Windows 7-Compatible Software
- ◆ RoHS Compliant
- ◆ Proven PCB Layout
- ◆ Fully Assembled and Tested

*Ordering Information appears at end of data sheet.*

### System Diagram

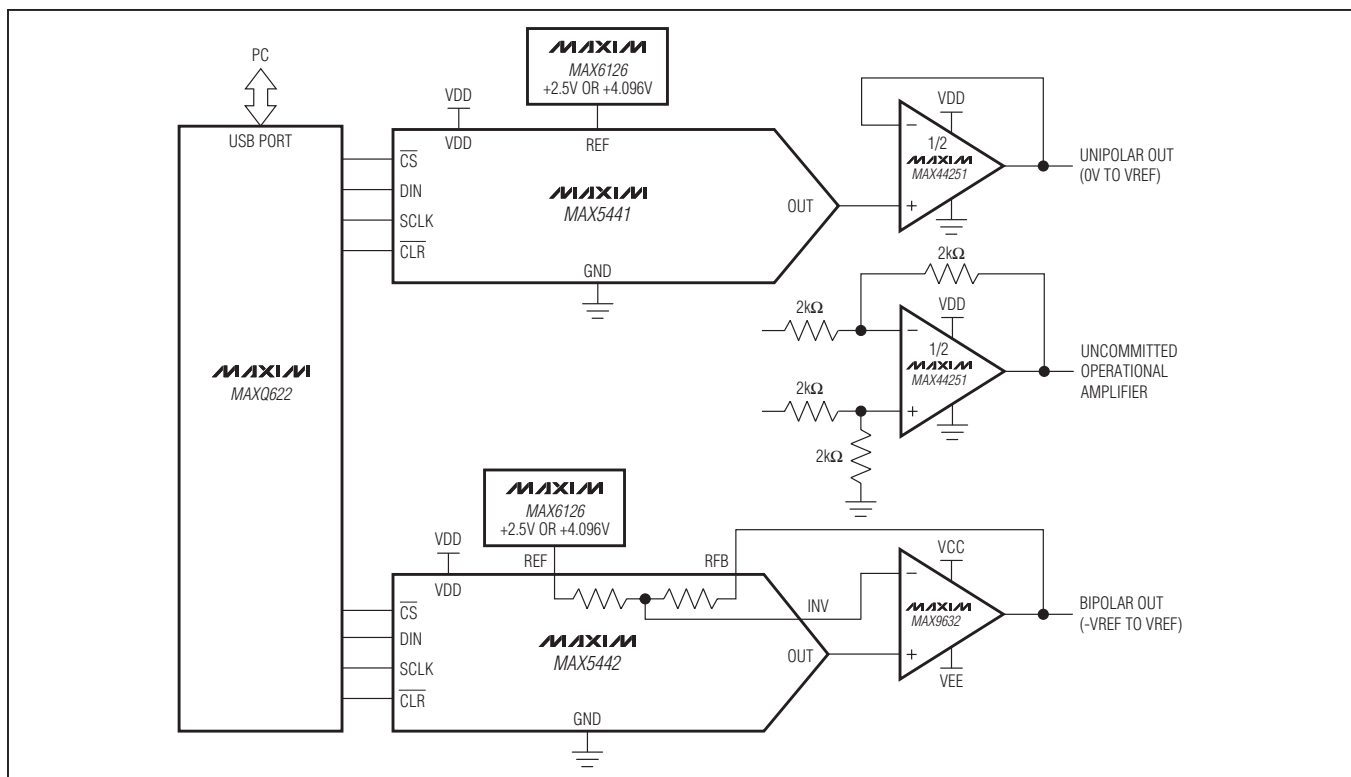

MAXQ is a registered trademark of Maxim Integrated Products, Inc.

Windows, Windows XP, and Windows Vista are registered trademarks of Microsoft Corp.

# MAX544X Evaluation Kit

## Evaluates: MAX5441–MAX5444

### Component List

DESIGNATION	QTY	DESCRIPTION
BUF_OUT1, BUF_OUT2, CLR0, CLR1, CS0, CS1, DINO, DIN1, INV, OUT1, OUT2, SCLK0, SCLK1, U3_OUTB	14	White test points
C1, C5, C9, C10, C14, C18–C22, C38, C40, C41, C42	14	0.1 $\mu$ F $\pm$ 10%, 16V X7R ceramic capacitors (0603) Murata GRM188R71C104K
C2, C6, C11, C15	4	0.01 $\mu$ F $\pm$ 10%, 50V X7R ceramic capacitors (0603) Murata GRM188R71H103K
C3, C7, C12, C16, C46, C47	6	1000pF $\pm$ 10%, 50V X7R ceramic capacitors (0603) Murata GRM188R71H102K
C4, C8, C13, C17	4	180pF $\pm$ 5%, 50V C0G ceramic capacitors (0603) Murata GRM1885C1H181J
C23–C33, C36, C37, C43, C44, C45	16	1 $\mu$ F $\pm$ 10%, 16V X5R ceramic capacitors (0603) Murata GRM188R61C105K
C34, C35	2	18pF $\pm$ 5%, 50V C0G ceramic capacitors (0603) Murata GRM1885C1H180J
C39	0	Not installed, ceramic capacitor (0603)
GND	5	Black test points
J1	1	USB type-B, right-angle PC-mount receptacle
J2	1	10-pin (2 x 5) dual-row header
J3	0	Not installed, 4-pin header
JU1, JU3–JU14	13	3-pin headers
JU2	1	4-pin header
JU15, JU16, JU17, JU_ID0–JU_ID3	7	2-pin headers
L1	1	Ferrite bead (0603) TDK MMZ1608R301A

DESIGNATION	QTY	DESCRIPTION
OP1+, OP2+, OP2-, REF, VDD	5	Red test points
R1, R5, R6	3	10k $\Omega$ $\pm$ 5% resistors (0603)
R2	1	100 $\Omega$ $\pm$ 5% resistor (0603)
R3, R4, R7, R8	4	2k $\Omega$ $\pm$ 5% resistors (0603)
U1	1	+5V unipolar voltage output, 16-bit DAC (8 $\mu$ MAX <sup>®</sup> ) Maxim 5441AEUA+
U2	1	+5V bipolar voltage output, 16-bit DAC (10 $\mu$ MAX) Maxim MAX5442AEUB+
U3	1	Output buffer (8 SOT23) Maxim MAX44251AKA+T
U4	1	Output buffer (8 SO) Maxim MAX9632ASA+
U5	1	2.5V voltage reference (8 SO) Maxim MAX6126AASA25+
U6, U7, U8	3	Level translators (10 $\mu$ MAX) Maxim MAX1840EUB+
U9	1	3.3V LDO (5 SC70) Maxim MAX8511EXK33+
U10	0	Not installed, ESD protector (6 SOT23)
U11	1	Microcontroller (64 LQFP) Maxim MAXQ622G-0000+
U12	1	4.096V voltage reference (8 SO) Maxim MAX6126AASA41+
Y1	1	12MHz crystal (HCM49)
—	1	USB high-speed A-to-B cables 5ft (1.5m)
—	1	MAX544X EV kit CD
—	21	Shunts
—	1	PCB: MAX5441/2/3/4 EVALUATION KIT

*$\mu$ MAX is a registered trademark of Maxim Integrated Products, Inc.*

# MAX544X Evaluation Kit

## Evaluates: MAX5441–MAX5444

### Component Suppliers

SUPPLIER	PHONE	WEBSITE
Murata Electronics North America Inc.	770-436-1300	www.murata-northamerica.com
TDK Corp.	847-803-6100	www.component.tdk.com

**Note:** Indicate the specific Maxim part number you are using when contacting these component suppliers.

### MAX544X EV Kit Files

FILE	DESCRIPTION
INSTALL.EXE	Installs the EV kit files on your computer
MAX544X.EXE	Application program
USBConverterDLL.DLL	Application library
UNINSTALL.EXE	Uninstalls the EV kit software

### Quick Start

#### Required Equipment

- MAX544X EV kit
- MAX544X EV kit CD
- User-supplied Windows XP, Windows Vista, or Windows 7 PC with a spare USB port
- Voltmeter

**Note:** In the following sections, software-related items are identified by bolding. Text in **bold** refers to items directly from the EV kit software. Text in **bold and underlined** refers to items from the Windows operating system.

#### Procedure

The EV kit is fully assembled and tested. Follow the steps below to verify board operation. **Caution: Do not turn on the power supply until all connections are completed.**

- 1) Visit [www.maxim-ic.com/evkitsoftware](http://www.maxim-ic.com/evkitsoftware) to download the latest version of the EV kit software, 544XRxx.ZIP. Save the EV kit software to a temporary folder and uncompress the ZIP file.
- 2) Install the EV kit software on your computer by running the INSTALL.EXE program inside the temporary folder. The program files are copied to your PC and icons are created in the Windows **Start | Programs** menu. During software installation, some versions of Windows may show a warning message indicating that this software is from an unknown publisher. This is not an error condition and it is safe to proceed with installation.
- 3) Verify that all jumpers are in their default positions, as shown in Table 2.
- 4) Connect the USB cable from the PC to the EV kit board; the USB driver is installed automatically.
- 5) Connect the positive input of the voltmeter to the BUF\_OUT1 connector. Connect the negative input of the voltmeter to the GND connector.
- 6) Start the EV kit software by opening its icon in the **Start | Programs** menu. The EV kit software main window appears, as shown in Figure 1.
- 7) The main window should display **Hardware Connected** in bottom-left corner.
- 8) In the **MAX5441** group box, enter **FFFF** in the **DIN Register** edit box and press the **Enter** button.
- 9) The voltmeter should show a voltage value of approximately +2.5V.
- 10) Connect the positive input of the voltmeter to the BUF\_OUT2 connector.
- 11) In the **MAX5442** group box, enter **FFFF** in the **DIN Register** edit box and press the **Enter** button.
- 12) The voltmeter should show a voltage value of approximately +2.5V.

# MAX544X Evaluation Kit

## Evaluates: MAX5441–MAX5444

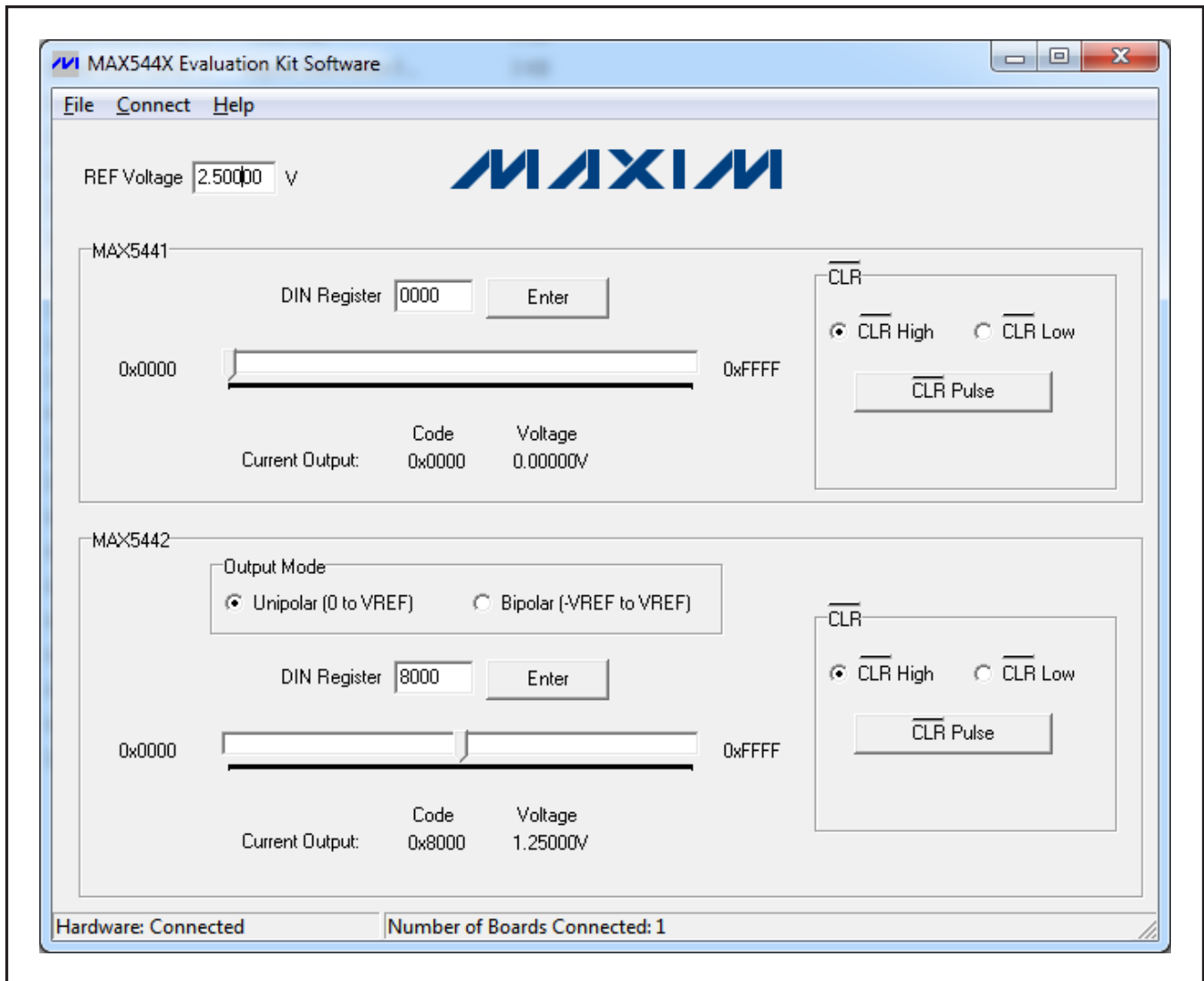

Figure 1. MAX544X Evaluation Kit Software (Main Window)

### Detailed Description of Software

In the main window of the evaluation software (Figure 1), the user can type in the reference voltage in the **REF Voltage** edit box. The software then calculates the DAC output voltages based on the reference voltage and the DAC input register value.

The **MAX5441** group box controls the MAX5441 unipolar DAC on the EV kit board. The **MAX5442** group box controls the MAX5442 bipolar DAC on the EV kit board.

To change the DAC input register value, type in the desired value in the **DIN Register** edit box and press the **Enter** button. The user can also move the track bar to change the DAC input register value. The DIN code and the target DAC output voltages are displayed for verification.

Selecting the **CLR High** radio button in the **MAX5441** group box sets the MAX5441  $\overline{\text{CLR}}$  pin high; selecting the **CLR Low** radio button sets the MAX5441  $\overline{\text{CLR}}$  pin low. Pressing the **CLR Pulse** button generates a low pulse on the MAX5441  $\overline{\text{CLR}}$  pin and clears the DAC buffer to code 0.

Selecting the **CLR High** radio button in the **MAX5442** group box sets the MAX5442  $\overline{\text{CLR}}$  pin high; selecting the **CLR Low** radio button sets the MAX5442  $\overline{\text{CLR}}$  pin low. Pressing the **CLR Pulse** button generates a low pulse on the MAX5442  $\overline{\text{CLR}}$  pin and clears the DAC buffer to code 0x8000 (32768).

For the MAX5442, the target output voltages are calculated based on the mode of the output buffer circuit.

Click on the **Connect** menu item to connect the board to the software if the USB connection is lost.

# MAX544X Evaluation Kit

## Evaluates: MAX5441–MAX5444

### **Detailed Description of Hardware**

The MAX544X EV kit provides a proven design to evaluate the MAX5441–MAX5444 serial-input, voltage-output, 16-bit DACs. The DACs are controlled by an on-board MAXQ microcontroller that provides two separate SPI control interfaces.

The EV kit provides on-board +2.5V and +4.096V high-precision voltage references. Use jumper JU2 to select from the different reference sources.

The EV kit connects one precision bipolar buffer (MAX9632) to the MAX5442 and one ultra-precision unipolar buffer (MAX44251) to the MAX5441.

The EV kit comes with the +5V MAX5441AEUA+ and +5V MAX5442AEUB+ installed; however, it can also be used

to evaluate other parts in the same family. Contact the factory for free samples of the pin-compatible devices shown in Table 1.

**Caution:** Refer to the MAX44251/MAX44252 and the MAX9632 IC data sheets for detailed specifications. Pay special attention when using the USB power supply to power the devices. When the DAC output is beyond the op amp's guaranteed input common-mode voltage range, use external power supplies instead.

### ***Bipolar Output Mode (MAX5442 Only)***

To allow the MAX5442 to operate in bipolar mode, connect a +5V supply to the OP2+ connector, connect a -5V supply to the OP2- connector, install a shunt across pins 1-2 on jumper JU15, and across pins 2-3 on jumpers JU12, JU13, and JU14.

**Table 1. Pin-Compatible Devices Selector Guide**

PART	TEMP RANGE	PIN-PACKAGE	INL (LSB)	SUPPLY (V)
<b>MAX5441</b> ACUA+	0°C to +70°C	8 $\mu$ MAX	$\pm 2$	5
MAX5441AEUA+	-40°C to +85°C	8 $\mu$ MAX	$\pm 2$	5
MAX5441BCUA+	0°C to +70°C	8 $\mu$ MAX	$\pm 4$	5
MAX5441BEUA+	-40°C to +85°C	8 $\mu$ MAX	$\pm 4$	5
<b>MAX5442</b> ACUB+	0°C to +70°C	10 $\mu$ MAX	$\pm 2$	5
MAX5442AEUB+	-40°C to +85°C	10 $\mu$ MAX	$\pm 2$	5
MAX5442BCUB+	0°C to +70°C	10 $\mu$ MAX	$\pm 4$	5
MAX5442BEUB+	-40°C to +85°C	10 $\mu$ MAX	$\pm 4$	5
<b>MAX5443</b> ACUA+	0°C to +70°C	8 $\mu$ MAX	$\pm 2$	3
MAX5443AEUA+	-40°C to +85°C	8 $\mu$ MAX	$\pm 2$	3
MAX5443BCUA+	0°C to +70°C	8 $\mu$ MAX	$\pm 4$	3
MAX5443BEUA+	-40°C to +85°C	8 $\mu$ MAX	$\pm 4$	3
<b>MAX5444</b> ACUB+	0°C to +70°C	10 $\mu$ MAX	$\pm 2$	3
MAX5444AEUB+	-40°C to +85°C	10 $\mu$ MAX	$\pm 2$	3
MAX5444BCUB+	0°C to +70°C	10 $\mu$ MAX	$\pm 4$	3
MAX5444BEUB+	-40°C to +85°C	10 $\mu$ MAX	$\pm 4$	3

# MAX544X Evaluation Kit

## Evaluates: MAX5441–MAX5444

**Table 2. Jumper Settings**

JUMPER	SHUNT POSITION	DESCRIPTION
JU1	1-2*	MAX5441/MAX5442 VDD connected to the USB power supply.
	2-3	MAX5441/MAX5442 VDD connected to the external power supply on the EXT_VDD connector.
JU2	1-2*	REF input connected to the on-board +2.5V voltage reference.
	1-3	REF input connected to the on-board +4.096V voltage reference.
	1-4	REF input connected to the external reference on the REF connector.
JU3	1-2*	MAX5441 SCLK pin connected to the MAXQ622.
	2-3	MAX5441 SCLK pin connected to the SCLK0 connector.
JU4	1-2*	MAX5441 DIN pin connected to the MAXQ622.
	2-3	MAX5441 DIN pin connected to the DIN0 connector.
JU5	1-2*	MAX5441 $\overline{CS}$ pin connected to the MAXQ622.
	2-3	MAX5441 $\overline{CS}$ pin connected to the CS0 connector.
JU6	1-2*	MAX44251 VDD connected to the USB power supply.
	2-3	MAX44251 VDD connected to the external power supply on the OP+ connector.
JU7	1-2*	MAX5442 SCLK pin connected to the MAXQ622.
	2-3	MAX5442 SCLK pin connected to the SCLK1 connector.
JU8	1-2*	MAX5442 DIN pin connected to the MAXQ622.
	2-3	MAX5442 DIN pin connected to the DIN1 connector.
JU9	1-2*	MAX5442 $\overline{CS}$ pin connected to the MAXQ622.
	2-3	MAX5442 $\overline{CS}$ pin connected to the CS1 connector.
JU10	1-2*	MAX5442 $\overline{CLR}$ pin connected to the MAXQ622.
	2-3	MAX5442 $\overline{CLR}$ pin connected to the $\overline{CLR1}$ connector.
JU11	1-2*	MAX5441 $\overline{CLR}$ pin connected to the MAXQ622.
	2-3	MAX5441 $\overline{CLR}$ pin connected to the $\overline{CLR0}$ connector.
JU12	1-2*	MAX9632 VEE connected to the analog ground.
	2-3	MAX9632 VEE connected to the external power supply on the OP2- connector.
JU13	1-2*	MAX9632 VCC connected to the USB power supply.
	2-3	MAX9632 VCC connected to the external power supply on the OP2+ connector.
JU14	1-2*	MAX9632 IN- input connected to the OUT output.
	2-3	MAX9632 IN- input connected to the INV signal of the MAX5442.
JU15	1-2	MAX5442 RFB input connected to the MAX9632 OUT output.
	Pin 1*	MAX5442 RFB input disconnected from the MAX9632 OUT output.
JU16	1-2*	MAX44251 INB- input connected to the analog ground through a 2k $\Omega$ resistor.
	Pin 1	MAX44251 INB- input disconnected from the analog ground.
JU17	1-2*	MAX44251 INB+ input connected to the analog ground through a 2k $\Omega$ resistor.
	Pin 1	MAX44251 INB+ input disconnected from the analog ground.
JU_ID0–JU_ID3	1-2*	Factory test jumpers.

# MAX544X Evaluation Kit

## Evaluates: MAX5441–MAX5444

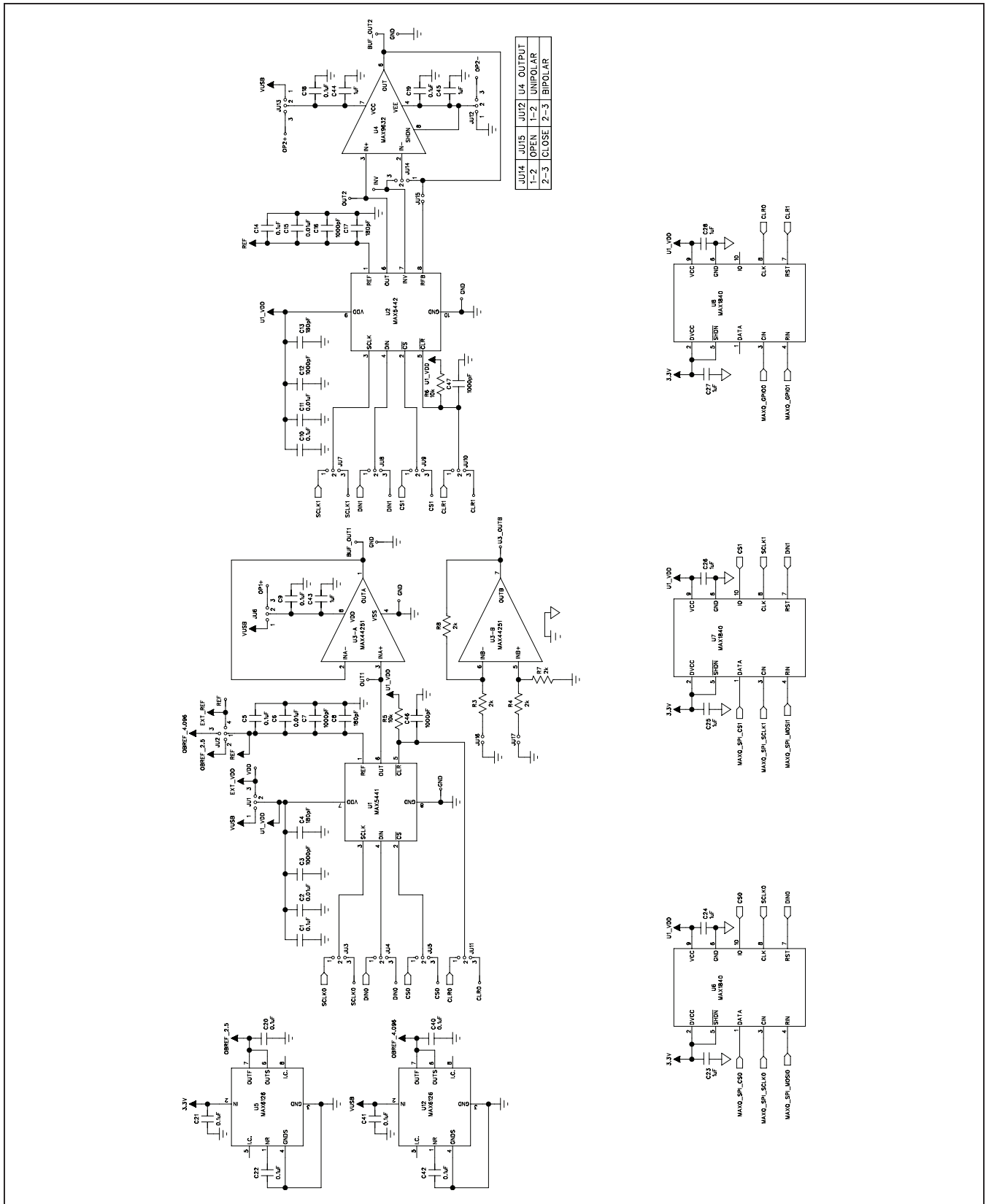

Figure 2a. MAX544X EV Kit Schematic (Sheet 1 of 2)

# MAX544X Evaluation Kit

## Evaluates: MAX5441-MAX5444

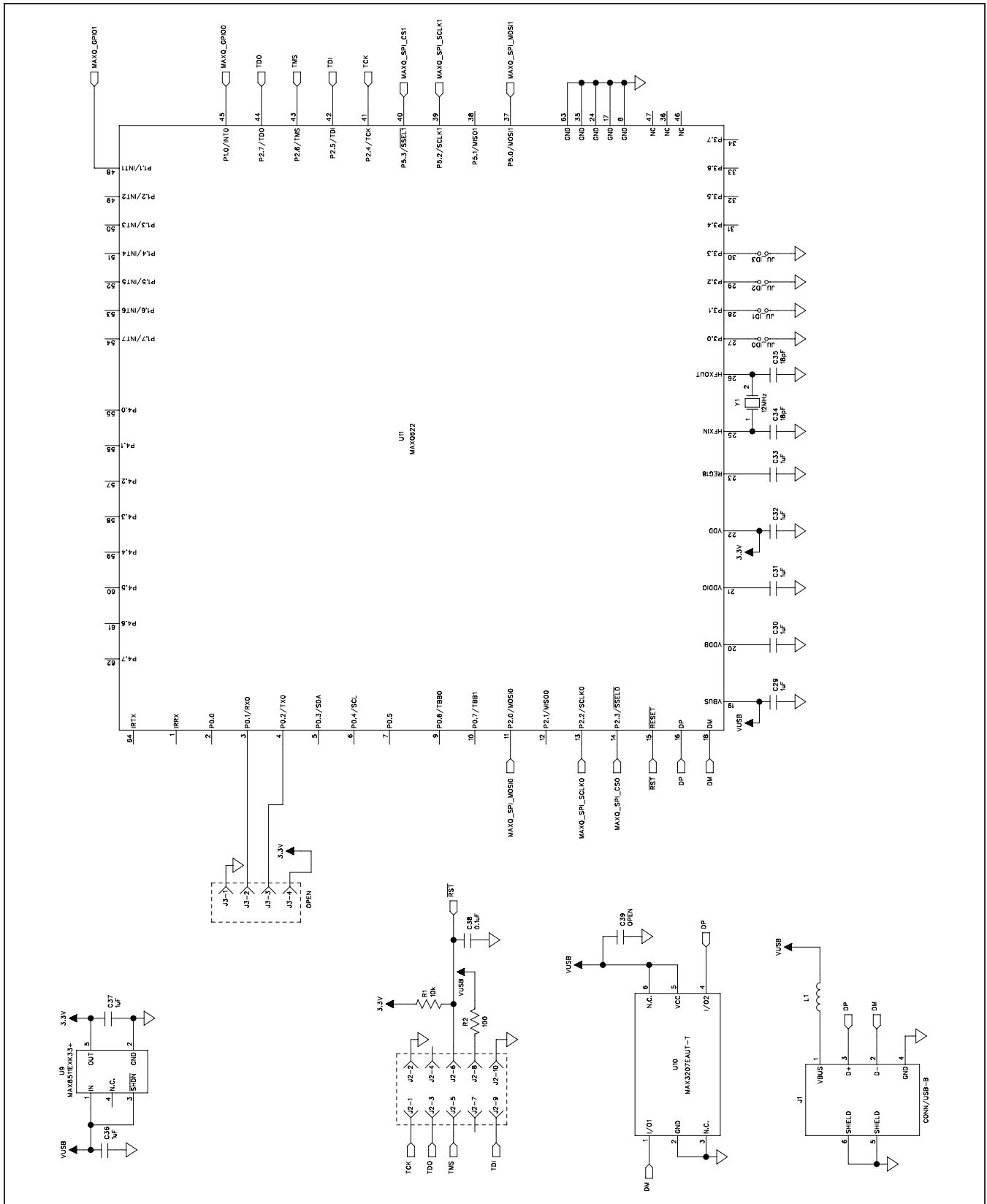

Figure 2b. MAX544X EV Kit Schematic (Sheet 2 of 2)



# MAX544X Evaluation Kit

## Evaluates: MAX5441–MAX5444

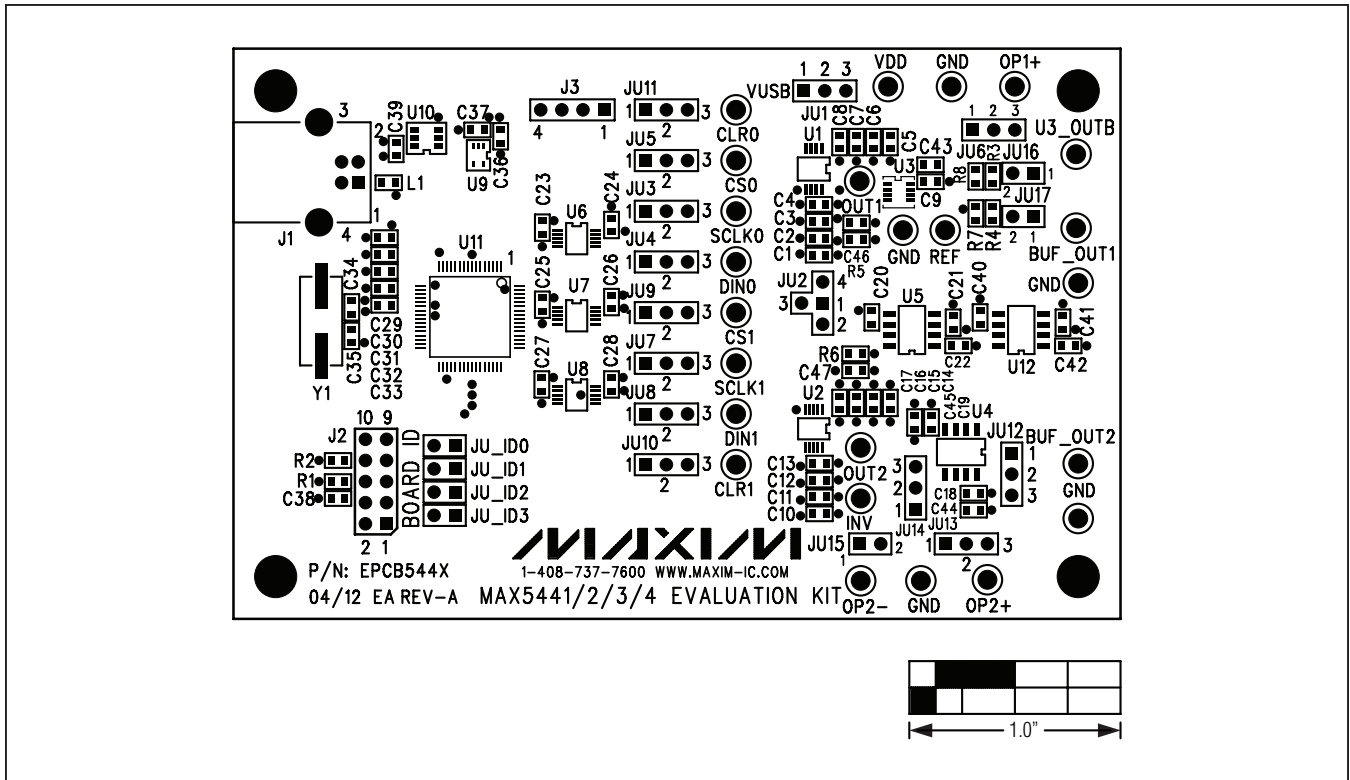

Figure 3. MAX544X EV Kit Component Placement Guide—Component Side

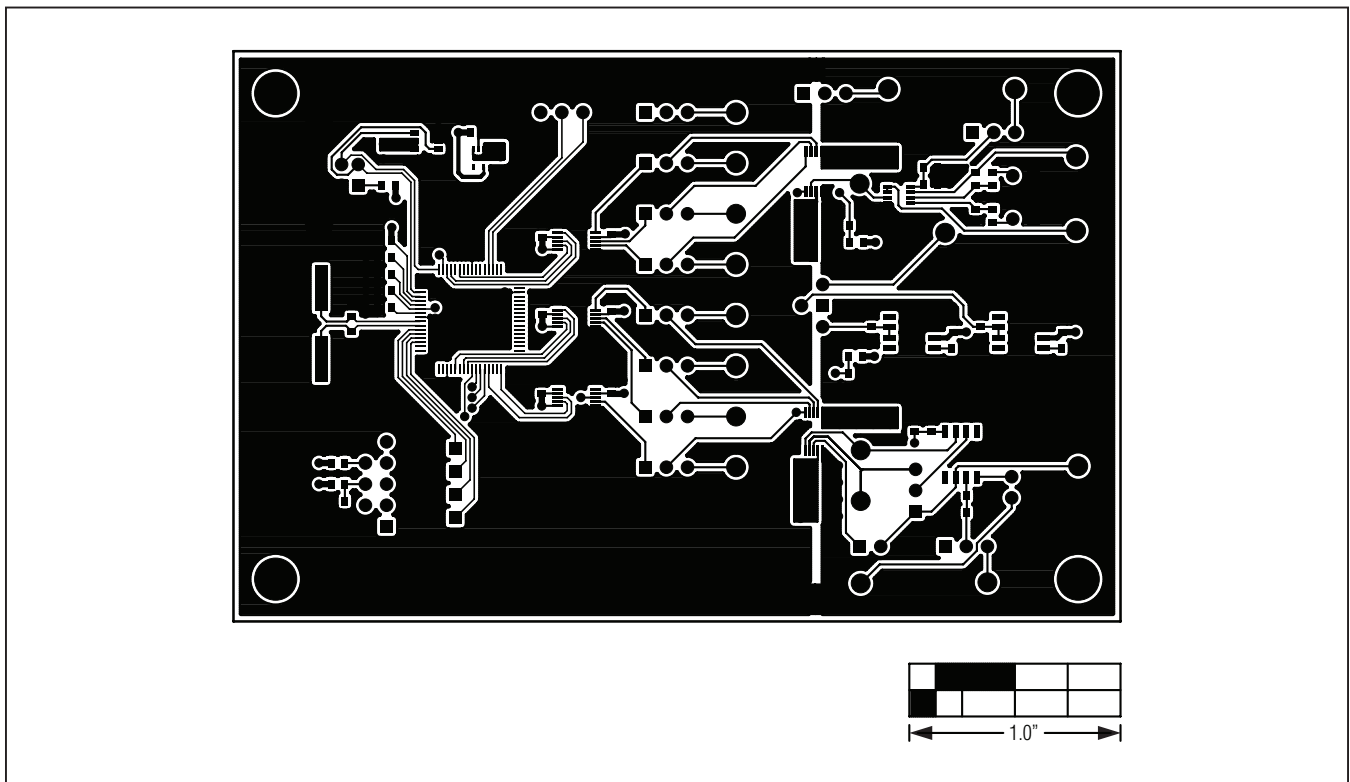

Figure 4. MAX544X EV Kit PCB Layout—Component Side

# MAX544X Evaluation Kit

## Evaluates: MAX5441–MAX5444

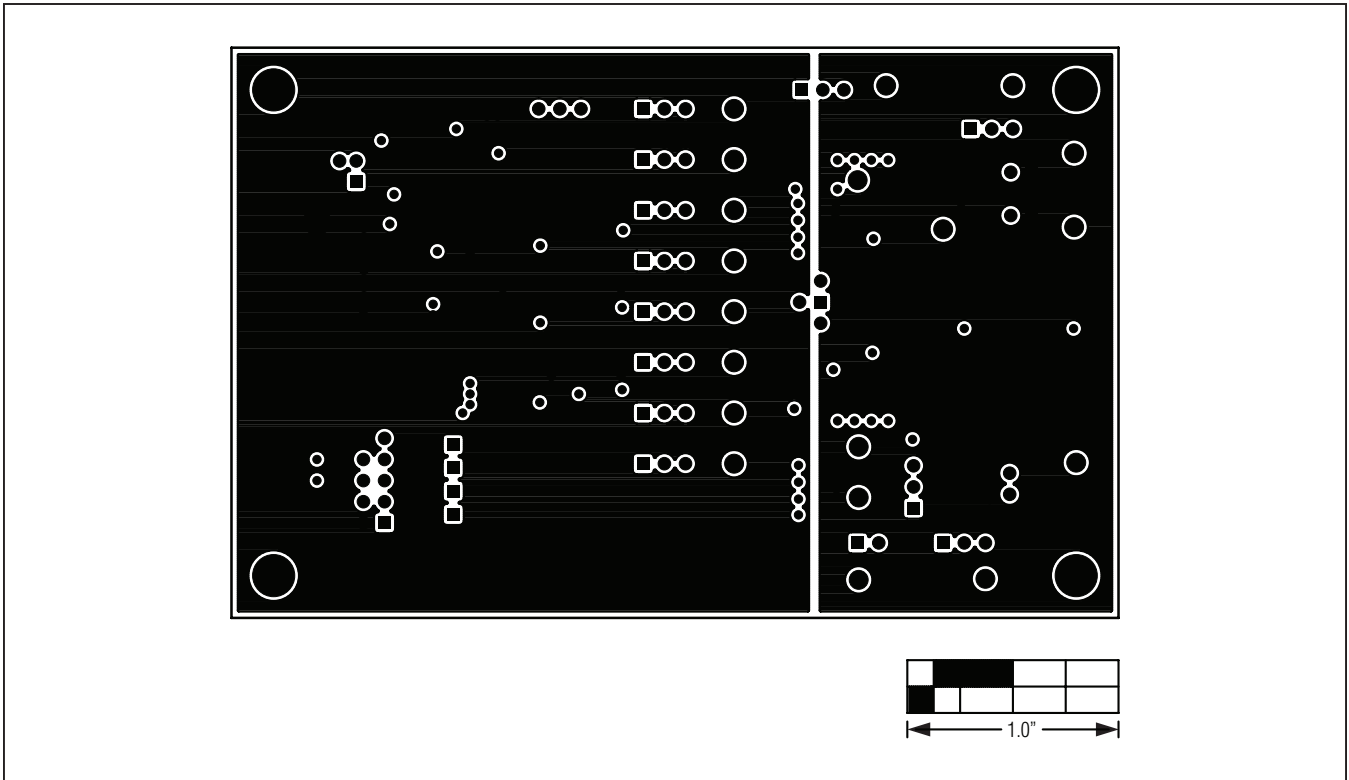

Figure 5. MAX544X EV Kit PCB Layout—Ground Layer 2

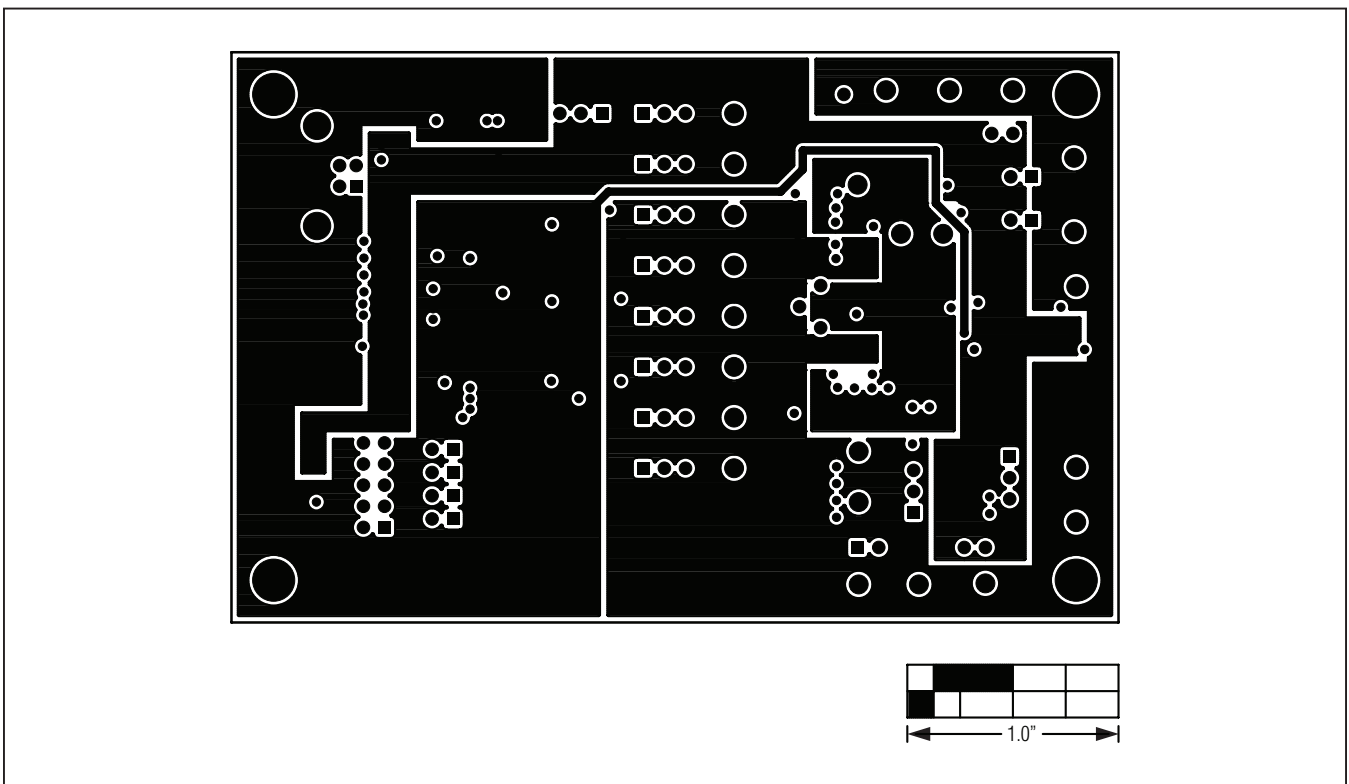

Figure 6. MAX544X EV Kit PCB Layout—Power Layer 3

# MAX544X Evaluation Kit

## Evaluates: MAX5441–MAX5444

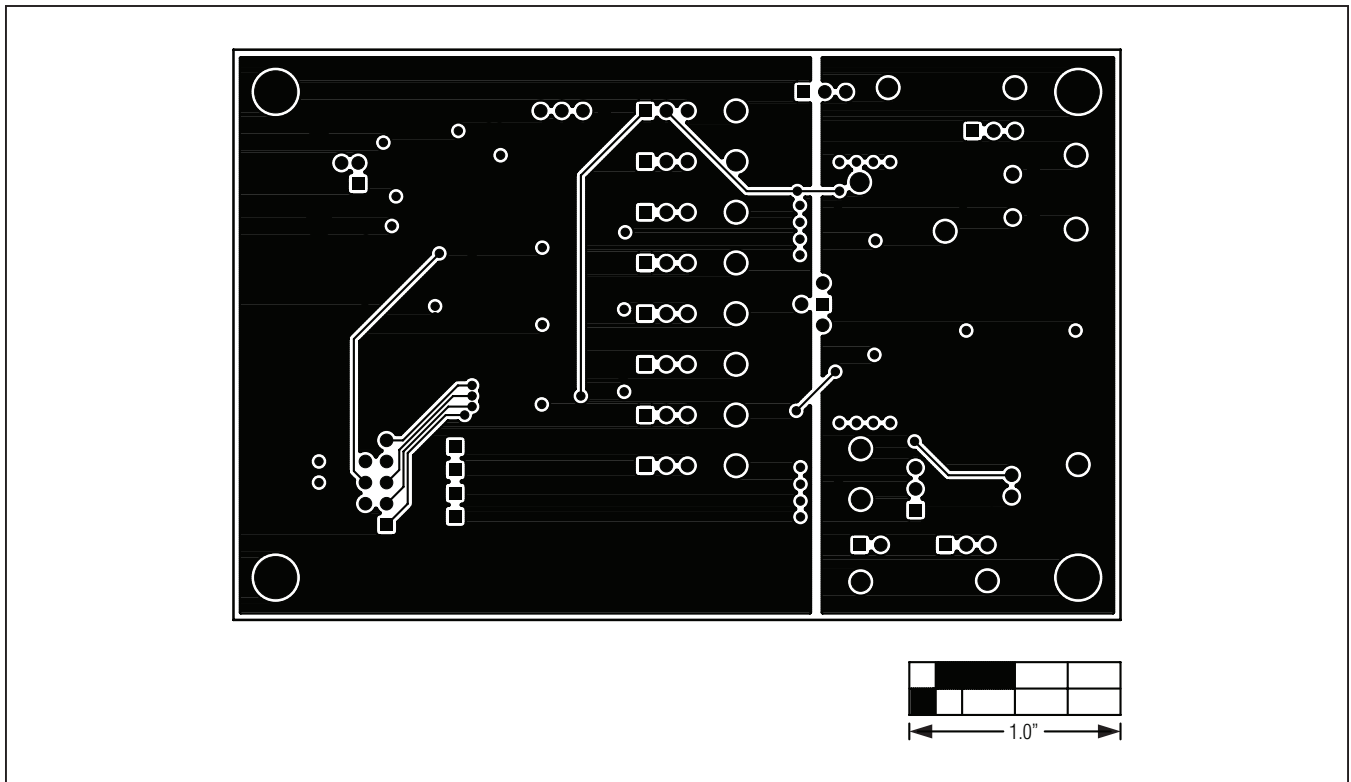

Figure 7. MAX544X EV Kit PCB Layout—Solder Side

# MAX544X Evaluation Kit

## Evaluates: MAX5441–MAX5444

### ***Ordering Information***

PART	TYPE
MAX544XEVKIT#	EV Kit

#Denotes RoHS-compliant.

# MAX544X Evaluation Kit

## Evaluates: MAX5441–MAX5444

### Revision History

REVISION NUMBER	REVISION DATE	DESCRIPTION	PAGES CHANGED
0	5/12	Initial release	—

*Maxim cannot assume responsibility for use of any circuitry other than circuitry entirely embodied in a Maxim product. No circuit patent licenses are implied. Maxim reserves the right to change the circuitry and specifications without notice at any time.*

**Maxim Integrated Products, 120 San Gabriel Drive, Sunnyvale, CA 94086 408-737-7600 \_\_\_\_\_ 13**