

Reference Only

Reference Spec. No. JENF243D-9101D-01

P 1 / 9

Chip EMIFIL LC Combined Monolithic

NFL18ZT□□□H1A3□

Reference Specification [AEC-Q200]

1. Scope

This reference specification applies to Chip EMIFIL LC Combined Type for Large Current NFL18ZT_H Series for Automotive Electronics based on AEC-Q200 except for Power train and Safety.

2. Part Numbering

NF	L	18	ZT	506	H	1A	3	D
Product ID	Structure	Dimension (L×W)	Features	Cut-off Frequency	Characteristics	Rated Voltage	Electrode	Packaging Code

(D: Taping / B: Bulk)

3. Rating

Customer Part Number	Murata Part Number	Cut-off Frequency [MHz]	Insertion Loss (I.L.)(dB)		Rated Voltage [V(DC)]	Withstanding Voltage [V(DC)]	Rated Current [mA(DC)]	Insulation Resistance [MΩmin.]	ESD Rank 1C:1kV
	NFL18ZT506H1A3D NFL18ZT506H1A3B	50	6 max (0-50MHz)	30min (200-1000MHz)	10	30	75	1000	1C
	NFL18ZT706H1A3D NFL18ZT706H1A3B	70	6 max (0-70MHz)	30min (300-1000MHz)					
	NFL18ZT107H1A3D NFL18ZT107H1A3B	100	6 max (0-100MHz)	30min (400-1000MHz)					
	NFL18ZT207H1A3D NFL18ZT207H1A3B	200	6 max (0-200MHz)	30min (800-1000MHz)					
	NFL18ZT307H1A3D NFL18ZT307H1A3B	300	6 max (0-300MHz)	30min (1200-1000MHz)			100		
	NFL18ZT507H1A3D NFL18ZT507H1A3B	500	6 max (0-500MHz)	30min (1700-1000MHz)					

<p><Capacitance> NFL18ZT506H1A3□: 110pF (typ.)</p> <p>NFL18ZT706H1A3□: 70pF (typ.)</p> <p>NFL18ZT107H1A3□: 50pF (typ.)</p> <p>NFL18ZT207H1A3□: 22pF (typ.)</p> <p>NFL18ZT307H1A3□: 16pF (typ.)</p> <p>NFL18ZT507H1A3□: 10pF (typ.)</p>	<p><Inductance> NFL18ZT506H1A3□: 350nH (typ.)</p> <p>NFL18ZT706H1A3□: 230nH (typ.)</p> <p>NFL18ZT107H1A3□: 150nH (typ.)</p> <p>NFL18ZT207H1A3□: 110nH (typ.)</p> <p>NFL18ZT307H1A3□: 74nH (typ.)</p> <p>NFL18ZT507H1A3□: 42nH (typ.)</p>
--	--

- Operating Temperature: - 55 °C to + 125 °C (Includes self-heating.)
- Storage Temperature: - 55 °C to + 125 °C

4. Standard Testing Condition

<Unless otherwise specified>

Temperature : Ordinary Temp. 15°C to 35°C
 Humidity : Ordinary Humidity 25 %(RH) to 85 %(RH)

<In case of doubt>

Temperature: 20°C ± 2°C
 Humidity : 60 %(RH) to 70 %(RH)
 Atmospheric pressure : 86kPa to 106kPa

Reference Only

5. Style and Dimensions

(Top View)

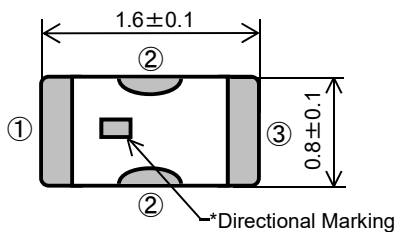

(Side View)

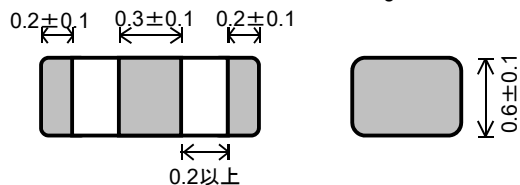

(Bottom View)

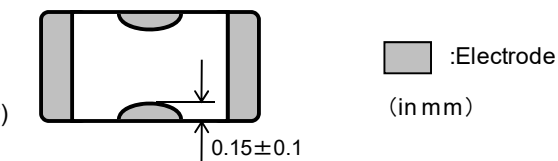

Equivalent Circuits

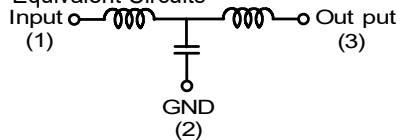

※No Polarity

Unit Mass(Typical value)

0.004g

*Directional Marking

There are no electrical polarity.

But there is a directional marking on the top of product to identify inner physical direction.

Insertion Loss Characteristics (I.L.) (Typ.) (50Ω system)

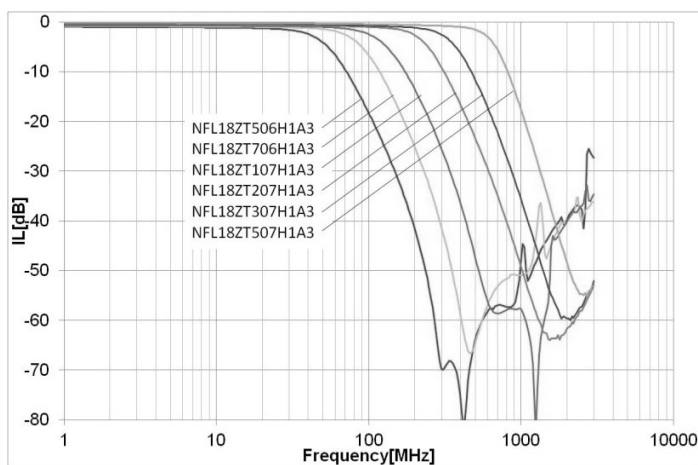

6. Marking

In case of polarity marking on the top, coils are placed in upper layer, and capacitor is placed in lower layer.

Reference Only

7. Electrical Performance

No.	Item	Specification	Test Method
7.1	Insertion Loss (I.L.)	Meet item 3.	<p style="text-align: center;">* Method of measurement based on MIL-STD-220</p> <p>Insertion Loss = $20 \log (E_0 / E_1)$ E_0 : Level without FILTER (short) E_1 : Level with FILTER</p>
7.2	Insulation Resistance(I.R.)		<ul style="list-style-type: none"> • Voltage : Rated Voltage • Time : 1 minutes max.
7.3	Withstanding Voltage	Products shall not be damaged.	<ul style="list-style-type: none"> • Test Voltage : 30V(DC) • Time : 1 to 5s • Charge Current : 50 mA max.

8. Q200 Requirement

8-1. Performance (based on Table 13 for Ferrite EMI SUPPRESSORS/FILTERS)

AEC-Q200 Rev.D issued June. 1 2010

AEC-Q200			Murata Specification / Deviation								
No.	Stress	Test Method									
3	High Temperature Exposure (Storage)	1000hours at 125C Set for 24hours at room temperature, then measured.	Meet TABLE A after testing. Table A <table border="1" style="margin-left: 20px; border-collapse: collapse;"> <tr> <td style="padding: 2px;">Appearance</td> <td style="padding: 2px;">No damaged</td> </tr> <tr> <td style="padding: 2px;">Cap. Change (%ΔC)</td> <td style="padding: 2px;">Within \pm 5%</td> </tr> <tr> <td style="padding: 2px;">Inductance Change (%ΔL)</td> <td style="padding: 2px;">Within \pm 10%</td> </tr> <tr> <td style="padding: 2px;">I.R.</td> <td style="padding: 2px;">Meet item 3</td> </tr> </table>	Appearance	No damaged	Cap. Change (% Δ C)	Within \pm 5%	Inductance Change (% Δ L)	Within \pm 10%	I.R.	Meet item 3
Appearance	No damaged										
Cap. Change (% Δ C)	Within \pm 5%										
Inductance Change (% Δ L)	Within \pm 10%										
I.R.	Meet item 3										
4	Temperature Cycling	1000cycles(-40C to 125C) Measurement at 24 \pm 2 hours after test conclusion.	Meet TABLE A after testing.								
5	Destructive Physical Analysis	Per EIA469 No electrical tests	No defects								
7	Biased Humidity	1000hours 85C/85%RH. Apply Maximum rated Voltage. Measurement at 24+/-2 hours after test conclusion.	Meet Table A after testing.								
8	Operational Life	1000hours at 125C Apply Maximum rated Current. Measurement at 24+/-2 hours after test conclusion.	Meet Table A after testing.								
9	External Visual	Visual inspection	No abnormalities								
10	Physical Dimension	Meet ITEM 4 (Style and Dimensions)	No defects								

Reference Only

AEC-Q200			Murata Specification / Deviation						
No.	Stress	Test Method							
12	Resistance to Solvents	Per MIL-STD-202 Method 215	Not Applicable						
13	Mechanical Shock	Per MIL-STD-202 Method 213 Figure 1 of Method 213. Condition C(100g's/6msec/Half sine) Three times each 6 direction.	Meet Table A after testing.						
14	Vibration	5g's for 20 minutes, 12cycles each of 3 orientations Oscillation Frequency : 10-2000Hz.	Meet Table A after testing.						
15	Resistance to Soldering Heat	No Pre-heating. 260C +/- 5degree C Immersion time 10 +/-1sec	Meet Table A after testing.						
17	ESD	Per AEC-Q200-002	Meet Table B after testing. ESD Rank: Refer to Item 3. Rating. Table B <table border="1" style="margin-left: 20px; border-collapse: collapse;"> <tr> <td style="padding: 2px;">Appearance</td> <td style="padding: 2px;">No damage</td> </tr> <tr> <td style="padding: 2px;">I.R.</td> <td style="padding: 2px;">1000M ohm min</td> </tr> <tr> <td style="padding: 2px;">Withstanding Voltage</td> <td style="padding: 2px;">No damage</td> </tr> </table>	Appearance	No damage	I.R.	1000M ohm min	Withstanding Voltage	No damage
Appearance	No damage								
I.R.	1000M ohm min								
Withstanding Voltage	No damage								
18	Solderability	Per J-STD-002	95% of the terminations is to be soldered.						
19	Electrical Characterization		No defects						
20	Flammability	Per UL-94	Not Applicable						
21	Board Flex	Epoxy-PCB(1.6mm) Deflection 2mm(min) 60s minimum holding time	Meet Table A after testing.						
22	Terminal Strength	Per AEC-Q200-006 A force of 17.7N for 60sec	10N for 60sec						
30	Electrical Transient Conduction	Per ISO-7637-2	Not Applicable						

10. Specification of Packaging

10.1. Appearance and Dimensions (8mm-wide paper tape)

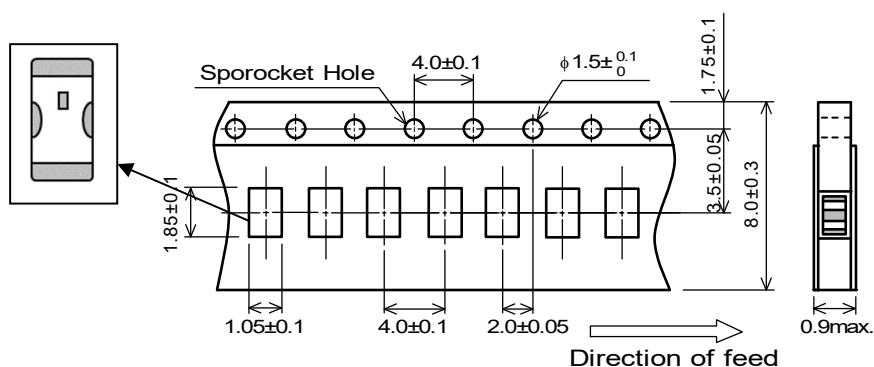

(in mm)

Reference Only

10.2. Specification of Taping

- (1) Packing quantity (standard quantity)
4000 pcs. / reel
- (2) Packing Method
Products shall be packaged in the cavity of the base tape and sealed by top tape and bottom tape.
- (3) Sprocket Hole
The sprocket holes are to the right as the tape is pulled toward the user.
- (4) Base tape and Top tape
The base tape and top tape have no spliced point.
- (5) Cavity
There shall not be burr in the cavity.
- (6) Missing components number
Missing components number within 0.025% of the number per reel or 1 pc., whichever is greater, and are not continuous. The specified quantity per reel is kept.

10.3. Pull Strength of Top Tape and Bottom Tape

Top tape	5N min.
Bottom tape	

10.4. Peeling off force of top tape

0.1N to 0.6N (minimum value is typical)
Speed of Peeling off : 300 mm / min

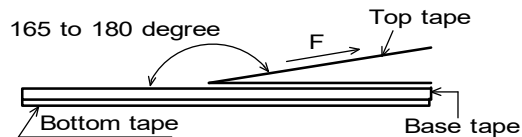

10.5. Dimensions of Leader-tape, Trailer and Reel

There shall be leader-tape (top tape and empty tape) and trailer-tape (empty tape) as follows.

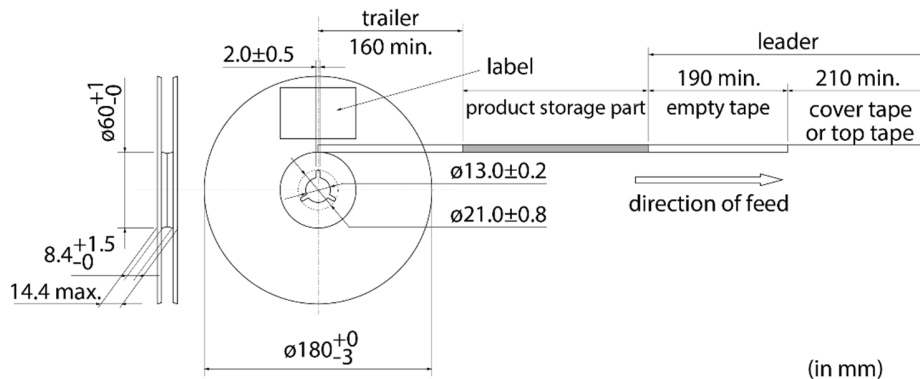

10.6. Marking for reel

Customer part number , MURATA part number , Inspection number(*1) , RoHS marking(*2) , Quantity , etc

*1) « Expression of Inspection No. »

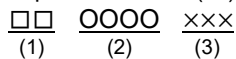

(1) Factory Code

(2) Date

(3) Serial No.

First digit : Year / Last digit of year

Second digit : Month / Jan. to Sep. → 1 to 9, Oct. to Dec. → O, N, D

Third, Fourth digit : Day

*2) « Expression of RoHS marking »

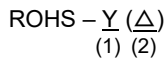

(1) RoHS regulation conformity parts.

(2) MURATA classification number

10.7. Marking for Outside package (corrugated paper box)

Customer name , Purchasing Order Number , Customer Part Number , MURATA part number , RoHS marking (*2) , Quantity , etc

Reference Only

10.8. Specification of Outer Case

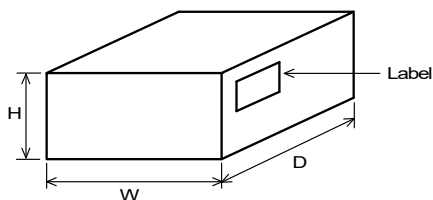

Outer Case Dimensions (mm)			Standard Reel Quantity in Outer Case (Reel)
W	D	H	
186	186	93	5

* Above Outer Case size is typical. It depends on a quantity of an order.

11. Standard Land Dimensions

The chip EMI filter suppresses noise by conducting the high-frequency noise element to ground. Therefore, to get enough noise reduction, feed through holes which is connected to ground-plane should be arranged according to the figure to reinforce the ground-pattern.

< Standard land dimensions for reflow >

·Side on which chips are mounted

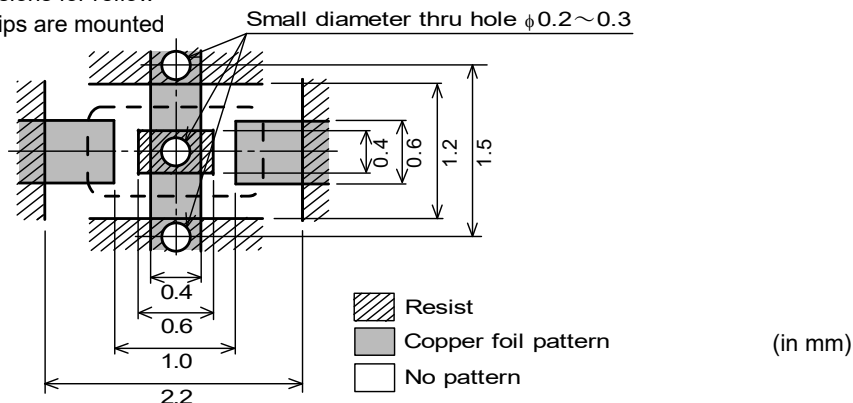

12. ⚠ Caution

12.1. Limitation of Applications

Please contact us before using our products for the applications listed below which require especially high reliability for the prevention of defects which might directly cause damage to the third party's life, body or property.

- (1) Aircraft equipment (2) Aerospace equipment (3) Undersea equipment (4) Power plant control equipment
- (5) Medical equipment (6) Transportation equipment (trains, ships, etc.) (7) Traffic signal equipment
- (8) Disaster prevention / crime prevention equipment (9) Data-processing equipment
- (10) Applications of similar complexity or with reliability requirements comparable to the applications listed in the above

12.2. Fail Safe

Be sure to provide an appropriate fail-safe function on your product to prevent from a second damage that may be caused by the abnormal function or the failure of our products.

12.3. Corrosive gas

Please refrain from use since contact with environments with corrosive gases (sulfur gas [hydrogen sulfide, sulfur dioxide, etc.], chlorine, ammonia, etc.) or oils (cutting oil, silicone oil, etc.) that have come into contact with the previously stated corrosive gas environment will result in deterioration of product quality or an open from deterioration due to corrosion of product electrode, etc. We will not bear any responsibility for use under these environments.

13. Notice

Products can only be soldered with reflow.

This product is designed for solder mounting.

Please consult us in advance for applying other mounting method such as conductive adhesive.

13.1. Flux and Solder

Flux	Use rosin-based flux, Do not use highly acidic flux (with chlorine content exceeding 0.2(wt)%). Do not use water-soluble flux.
Solder	Use Sn-3.0Ag-0.5Cu solder

Other flux (except above) Please contact us for details, then use.

Reference Only

13.2. Note for Assembling

< Thermal Shock >

Pre-heating should be in such a way that the temperature difference between solder and products surface is limited to 100°C max. Also cooling into solvent after soldering should be in such a way that the temperature difference is limited to 100°C max.

13.3. Attention Regarding P.C.B. Bending

The following shall be considered when designing P.C.B.'s and laying out products.

(1) P.C.B. shall be designed so that products are not subject to the mechanical stress for board warpage.

[Products direction]

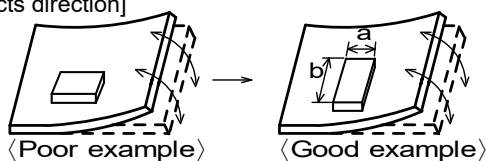

Products shall be located in the sideways direction (Length: $a < b$) to the mechanical stress.

(2) Components location on P.C.B. separation.

It is effective to implement the following measures, to reduce stress in separating the board.

It is best to implement all of the following three measures; however, implement as many measures as possible to reduce stress.

Contents of Measures	Stress Level
(1) Turn the mounting direction of the component parallel to the board separation surface.	$A > D *1$
(2) Add slits in the board separation part.	$A > B$
(3) Keep the mounting position of the component away from the board separation surface.	$A > C$

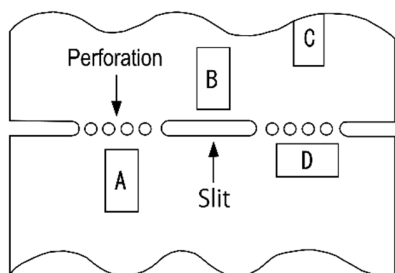

*1 $A > D$ is valid when stress is added vertically to the perforation as with Hand Separation. If a Cutting Disc is used, stress will be diagonal to the PCB, therefore $A > D$ is invalid.

(3) Mounting Components Near Screw Holes

When a component is mounted near a screw hole, it may be affected by the board deflection that occurs during the tightening of the screw. Mount the component in a position as far away from the screw holes as possible.

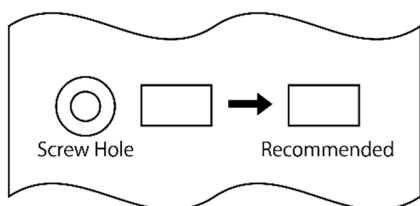

13.4. Pre-heating Temperature

Soldering shall be handled so that the difference between pre-heating temperature and solder temperature shall be limited to 100°C max. to avoid the heat stress for the products.

13.5. Reflow Soldering

1) Soldering paste printing for reflow

- Standard thickness of solder paste: 100µm to 150µm.
- Use the solder paste printing pattern of the right pattern.
- For the resist and copper foil pattern, use standard land dimensions.

• Standard printing pattern of solder paste.

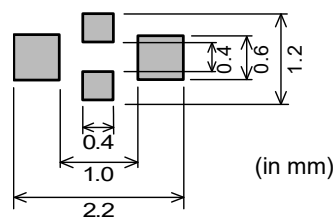

Reference Only

2) Soldering Conditions

Standard soldering profile and the limit soldering profile is as follows.

The excessive limit soldering conditions may cause leaching of the electrode and / or resulting in the deterioration of product quality.

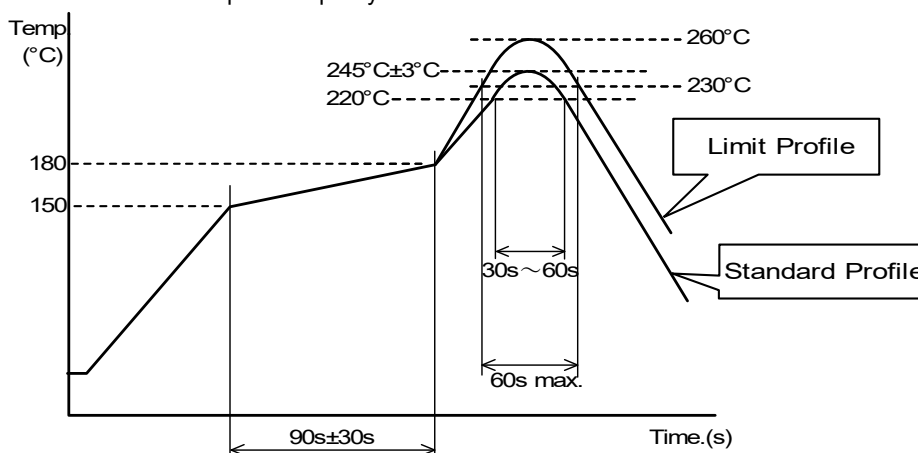

	Standard Profile	Limit Profile
Pre-heating	150°C ~ 180°C , 90s ± 30s	
Heating	above 220°C , 30s ~ 60s	above 230°C , 60s max.
Peak temperature	245°C ± 3°C	260°C , 10s
Cycle of reflow	2 times	2 times

13.6. Reworking with Soldering iron

The following conditions shall be strictly followed when using a soldering iron.

- Pre-heating : 150°C, 1 min
- Tip temperature : 350°C max.
- Soldering time : 3(+1,-0) s
- Soldering iron output : 30W max.
- Tip diameter : φ 3mm max.
- Times : 2times max.

Note :Do not directly touch the products with the tip of the soldering iron in order to prevent the crack on the ceramic material due to the thermal shock.

13.7. Solder Volume

Solder shall be used not to be exceeded as shown below.

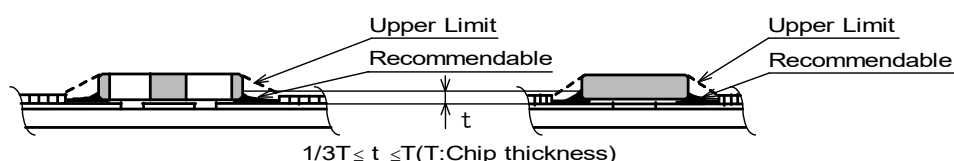

Accordingly increasing the solder volume, the mechanical stress to product is also increased. Excessive solder volume may cause the failure of mechanical or electrical performance.

13.8. Cleaning Conditions

Products shall be cleaned on the following conditions.

- (1) Cleaning temperature shall be limited to 60°C max. (40°C max. for Isopropyl alcohol (IPA))
- (2) Ultrasonic cleaning shall comply with the following conditions, with avoiding the resonance phenomenon at the mounted products and P.C.B.
 - Power: 20W / l max.
 - Frequency: 28kHz to 40kHz
 - Time: 5 minutes max.
- (3) Cleaner
 1. Cleaner
 - Isopropyl alcohol (IPA)
 2. Aqueous agent
 - PINE ALPHA ST-100S

Reference Only

(4) There shall be no residual flux and residual cleaner after cleaning.

In the case of using aqueous agent, products shall be dried completely after rinse with de-ionized water in order to remove the cleaner.

(5) Other cleaning

Please contact us.

13.9. Operating Environment

Do not use this product under the following environmental conditions, on deterioration of the Insulation Resistance of the Ferrite material and/or corrosion of Inner Electrode may result from the use.

- (1) In the corrodible atmosphere such as acidic gases, alkaline gases, chlorine, sulfur gases, organic gases and etc.
(the sea breeze, Cl₂, H₂S, NH₃, SO₂, NO₂, etc)
- (2) in the atmosphere where liquid such as organic solvent, may splash on the products.
- (3) in the atmosphere where the temperature / humidity changes rapidly and it is easy to dew.

13.10. Resin coating

The capacitance and inductance value may change and/or it may affect on the product's performance due to high cure-stress of resin to be used for coating / molding products. So please pay your careful attention when you select resin. In prior to use, please make the reliability evaluation with the product mounted in your application set.

13.11. Handling of a substrate

After mounting products on a substrate, do not apply any stress to the product caused by bending or twisting to the substrate when cropping the substrate, inserting and removing a connector from the substrate or tightening screw to the substrate.

Excessive mechanical stress may cause cracking in the product.

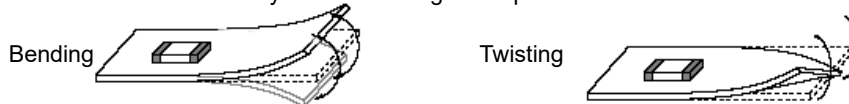

13.12. Storage condition

(1) Storage period

Use the products within 12 months after delivered.

Solderability should be checked if this period is exceeded.

(2) Storage environment condition

· Products should be stored in the warehouse on the following conditions.

Temperature : -10 to +40°C

Humidity : 15 to 85% relative humidity

No rapid change on temperature and humidity

- Don't keep products in corrosive gases such as sulfur, chlorine gas or acid, or it may cause oxidization of electrode, resulting in poor solderability.
- Products should be stored on the palette for the prevention of the influence from humidity, dust and so on.
- Products should be stored in the warehouse without heat shock, vibration, direct sunlight and so on.
- Avoid storing the product by itself bare (i.e. exposed directly to air).

(3) Delivery

Care should be taken when transporting or handling product to avoid excessive vibration or mechanical shock.

14. Note

- (1) Please make sure that your product has been evaluated in view of your specifications with our product being mounted to your product.
- (2) You are requested not to use our product deviating from the reference specifications.
- (3) The contents of this reference specification are subject to change without advance notice. Please approve our product specifications or transact the approval sheet for product specifications before ordering.