

Valueline VL FPM...

Flat panel monitor for the industrial environment



Data sheet
2983_en_C

© PHOENIX CONTACT 2014-05-05

1 Description

Valueline VL FPM... is a line of industrial flat panel monitors. The VL FPM... can be used in applications where a remote display location is required.

VL FPM... monitors can be mounted in an enclosure (panel mount) or attached to a VESA mount. The VL FPM... works together with any Valueline blind node IPC, including the VL BPC MINI box PC, or with any computer with a VGA or DVI port.

2 Features

- Display sizes from 12 to 19 inches
- Integrated resistive touch screen
- Integrated configuration buttons
- Panel mounting option (cut out in a panel)
- VESA MIS-D (100 or 75) C mounting
- Front USB port option
- Auxiliary USB ports for mouse and keyboard
- Includes 1.8 m DVI, VGA and USB cables



NOTE:

Circuit ground (0 V) and functional earth ground (FE) are connected.



Make sure you always use the latest documentation.
It can be downloaded at phoenixcontact.net/products.



This data sheet is valid for all products listed on the following page:

3 Ordering data

Products

Description	Type	Order No.	Pcs. / Pkt.
LCD touch screen monitor, 12 in.	VL FPM 12	2913015	1
LCD touch screen monitor, 12 in. with front bezel USB port	VL FPM 12U	2913016	1
LCD touch screen monitor, 15 in.	VL FPM 15	2913017	1
LCD touch screen monitor, 15 in. with front bezel USB port	VL FPM 15U	2913018	1
LCD touch screen monitor, 17 in.	VL FPM 17	2913019	1
LCD touch screen monitor, 17 in. with front bezel USB port	VL FPM 17U	2913020	1
LCD touch screen monitor, 19 in. with front bezel USB port	VL FPM 19U	2913021	1

4 Technical data

VL FPM 19U

Ambient temperature (operating)	0 ... 50°C
Ambient temperature (storage/transport)	-40 ... 70°C
Permissible humidity (relative)	5 ... 95% non-condensing
Weight	9.51 kg
Mounting	Panel cutout with bezel VESA MIS-D (100 or 75) C
Degree of protection	IP65 (front), IP20 (back)
LED indicators	Power
Power supply, nominal	24 V DC
Power supply, range	19.2 - 28.8 V DC
Current draw, maximum	2.15 A (19.2 V DC)
Power connector	3-pos. removable Combicon (Order No. 1786844)
Video signal	VGA or DVI-D
Overall dimensions, including bezel (W x H x D)	489 x 406 x 95 mm
Screen size, diagonal	483 mm (19.0 in.)
Screen size, horizontal x vertical	376 X 301 mm
Resolution	1280 x 1024
Type	Resistive touch screen with serial/USB interface
Brightness	300 Cd/m ²
Number of colors	16.7 million
Contrast ratio	1300:1
View angle, horizontal/vertical (CR=10), typ.	89°/89°
Installation cutout dimensions (W x H)	444 x 362 mm
Outside bezel dimensions (W x H x D)	489 x 406 x 10 mm
Backlight life, minimum	50000 hr.
Interface	USB 1.1/2.0, Type A

VL FPM 17(U)

Ambient temperature (operating)	0 ... 50°C
Ambient temperature (storage/transport)	-40 ... 70°C
Permissible humidity (relative)	5 ... 95% non-condensing
Weight	6.43 kg
Mounting	Panel cutout with bezel VESA MIS-D (100 or 75) C
Degree of protection	IP65 (front), IP20 (back)
LED indicators	Power
Power supply, nominal	24 V DC
Power supply, range	19.2 - 28.8 V DC

VL FPM 17(U) (Continued)

Current draw, maximum	1.94 A (19.2 V DC)
Power connector	3-pos. removable Combicon (Order No. 1786844)
Video signal	VGA or DVI-D
Overall dimensions, including bezel (W x H x D)	452 x 356.5 x 97 mm
Screen size, diagonal	430 mm (16.93 in.)
Screen size, horizontal x vertical	338 x 270 mm
Resolution	1280 x 1024
Type	Resistive touch screen with serial/USB interface
Brightness	350 Cd/m ²
Number of colors	16.7 million
Contrast ratio	1000:1
View angle, horizontal/vertical (CR=10), typ.	85°/80°
Installation cutout dimensions (W x H)	424 x 330 mm
Outside bezel dimensions (W x H x D)	452 x 357 x 10 mm
Backlight life, minimum	50000 hr.
Interface	USB 1.1/2.0, Type A

VL FPM 15(U)

Ambient temperature (operating)	0 ... 55°C
Ambient temperature (storage/transport)	-40 ... 70°C
Permissible humidity (relative)	5 ... 95% non-condensing
Weight	4.51 kg
Mounting	Panel cutout with bezel VESA MIS-D (100 or 75) C
Degree of protection	IP65 (front), IP20 (back)
LED indicators	Power
Power supply, nominal	24 V DC
Power supply, range	19.2 - 28.8 V DC
Current draw, maximum	1.31 A (19.2 V DC)
Power connector	3-pos. removable Combicon (Order No. 1786844)
Video signal	VGA or DVI-D
Overall dimensions, including bezel (W x H x D)	410 x 309 x 94 mm
Screen size, diagonal	378 mm (14.9 in.)
Screen size, horizontal x vertical	304 x 228 mm
Resolution	1024 x 768
Type	Resistive touch screen with serial/USB interface
Brightness	350 Cd/m ²
Number of colors	16.2 million
Contrast ratio	700:1
View angle, horizontal/vertical (CR=10), typ.	70°/65°
Installation cutout dimensions (W x H)	387 x 285 mm
Outside bezel dimensions (W x H x D)	410 x 309 x 10 mm
Backlight life, minimum	50000 hr.
Interface	USB 1.1/2.0, Type A

VL FPM 12(U)	
Ambient temperature (operating)	0 ... 55°C
Ambient temperature (storage/transport)	-40 ... 70°C
Permissible humidity (relative)	5 ... 95% non-condensing
Weight	4.47 kg
Mounting	Panel cutout with bezel VESA MIS-D (100 or 75) C
LED indicators	Power
Video signal	VGA or DVI-D
Power supply, nominal	24 V DC
Power supply, range	19.2 - 28.8 V DC
Current draw, maximum	1.05 A (19.2 V DC)
Power connector	3-pos. removable Combicon (Order No. 1786844)
Degree of protection	IP65 (front), IP20 (back)
Overall dimensions, including bezel (W x H x D)	365 x 282 x 92 mm
Screen size, diagonal	307 mm (12.1 in.)
Screen size, horizontal x vertical	246 x 185 mm
Resolution	800 x 600
Type	Resistive touch screen with serial/USB interface
Brightness	400 Cd/m ²
Number of colors	16.2 million
Contrast ratio	600:1
View angle, horizontal/vertical (CR=10), typ.	70°/60°
Installation cutout dimensions (W x H)	334 x 253 mm
Outside bezel dimensions (W x H x D)	365 x 282 x 10 mm
Backlight life, minimum	50000 hr.
Interface	USB 1.1/2.0, Type A

5 Installation

5.1 Panel installation

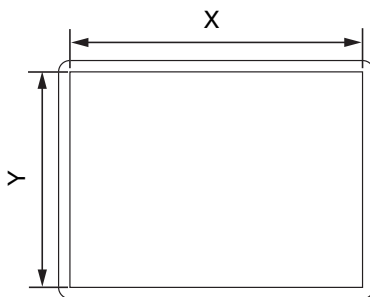

Figure 1 Cutout dimensions

Panel mount installs the display in an enclosure or control cabinet.



NOTE:

Connectors and switches must be accessible from the rear.

A wall panel thickness of at least 1.9 mm (14 ga.) is required for correct mounting with IP65 protection.

1. Cut a hole in the enclosure for the display size to be installed.

Display size	Horizontal (X)	Vertical (Y)
12 in.	334 mm	253 mm
15 in.	387 mm	285 mm
17 in.	424 mm	330 mm
19 in.	444 mm	362 mm

2. From the front, push the VL FPM... through the opening. Ensure the gasket is properly positioned in the groove.

- From the rear, place the display clamps, 1, in the slots, 2, on the display and slide the clamp to the right. All eight clamps must be used, one in every slot.

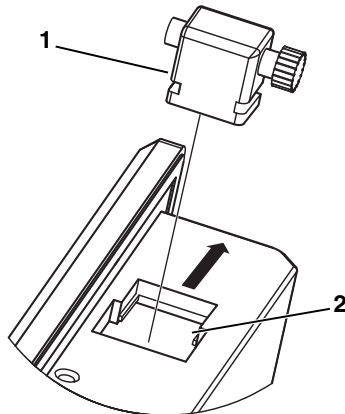

Figure 2 Monitor mounting clamp

- Tighten the screws on all clamps, alternating from one side to the other until the front bezel is secure against the mounting cutout. Torque the bolts to 1.2 Nm.

5.2 VESA mounting

In addition to panel installation, the VL FPM... can be installed on a VESA mount. The rear of the VL FPM... conforms to both the 75 and 100 mm variants of the VESA MIS-D mounting standard.



M4 hardware is not included. It is typically included with the VESA mount, which must be purchased separately.

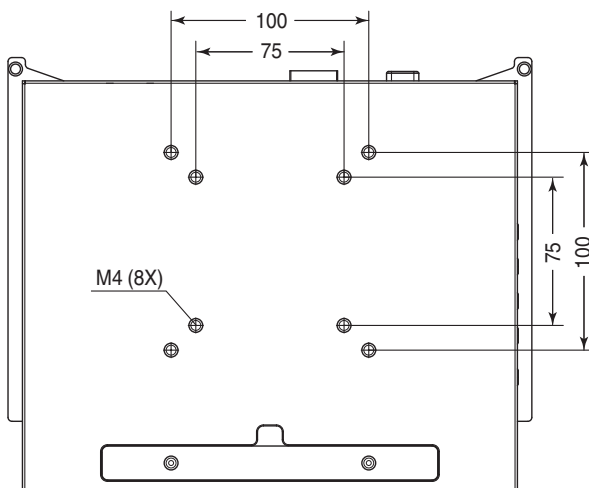

Figure 3 VESA mounting pattern

5.3 Connections

Connectors to interface with the computer are located on the rear bottom of the VL FPM....

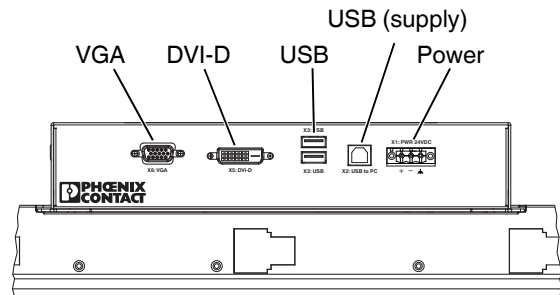

Figure 4 Monitor connections

- Power:** Connect 24 V DC power to the included removable power connector (Order No. 1786844). This connector supports wire sizes from 0.2 to 2.5 mm² (24 to 12 AWG). Tighten the wire retaining screws using 0.5 Nm (4.4 lb_f-ft) torque.
- USB (supply):** USB Type B port connects to a USB port on the computer. When connected, this allows the monitor to function as a touch screen and/or USB hub to other devices (1.8 m USB cable included).
- USB:** USB Type A ports allow USB devices to interface with the computer.
- DVI-D:** This DVI-D port connects to the computer to receive digital (DVI) video signals (1.8 m DVI cable included).
- VGA:** This DB-15 port connects to the computer to receive analog video signals (1.8 m VGA cable included).

6 Operation

Control buttons are located on the side of the monitor. Note that, once installed in a panel, they are not accessible from outside the panel.

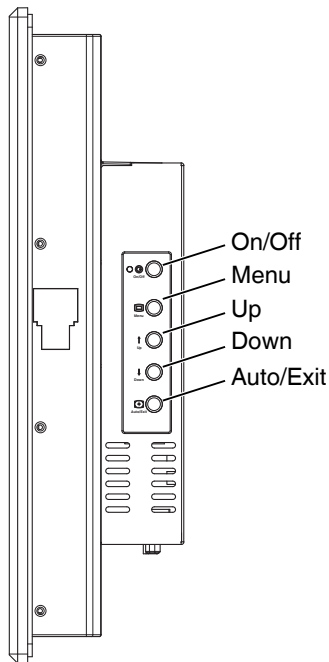

Figure 5 Control buttons

- On/Off: Press to turn the monitor power on or off.
- Menu: Press to open the on-screen display menu.
- Up: Press to highlight the selection above the current selection.
- Down: Press to highlight the selection below the current selection.
- Auto/Exit: Press to exit the on-screen display menu. If a VGA source is connected to the display, the button will perform an automatic calibration of the display.

To activate the on-screen display, press the “Menu” button. As you navigate through the menu using the “Up” and “Down” buttons, the current status of each option appears. Some screens have multiple selections.

To enter into a screen and change the settings, press the “Menu” button and change the settings using the “Up” and “Down” buttons. When the desired setting is reached, press the “Auto/Exit” button to exit the configuration mode.

7 On-screen display selections

7.1 Connection method

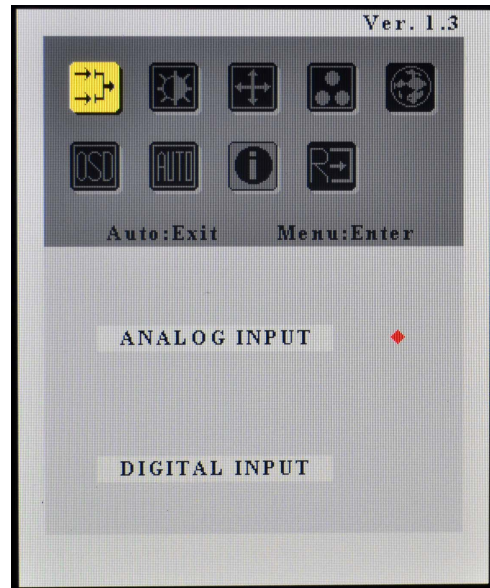

Figure 6 Opening screen

The first screen displayed indicates the connection method of the monitor, either analog or digital. This is automatically selected if connected through a single source. If two connection sources are available, use the “Up” and “Down” buttons to change the setting as desired. When finished, press the “Auto/Exit” button to exit the edit mode.

7.2 Appearance

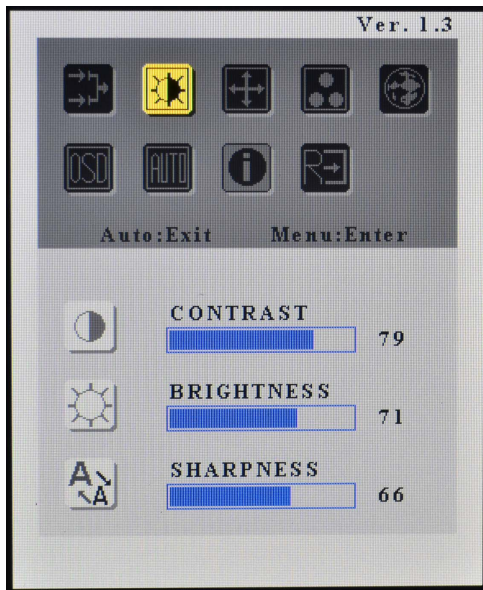

Figure 7 Appearance screen

The second icon on the top row provides access to contrast, brightness and sharpness settings.

To modify a setting, use the “Up” and “Down” buttons to highlight the desired setting, press the “Menu” button to enter edit mode and use the “Up” and “Down” buttons to change the setting as desired. When finished, press the “Auto/Exit” button to exit the edit mode.

7.3 Focus and position

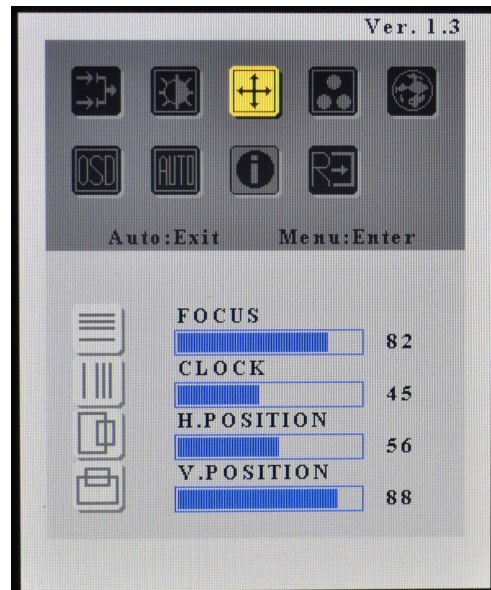

Figure 8 Focus and position screen

The third icon on the top row provides access to the focus, refresh rates (clock), horizontal and vertical positioning.

To modify a setting, use the “Up” and “Down” buttons to highlight the desired setting, press the Menu button to enter edit mode and use the “Up” and “Down” buttons to change the setting as desired. When finished, press the “Auto/Exit” button to exit the edit mode.

7.4 Color temperature

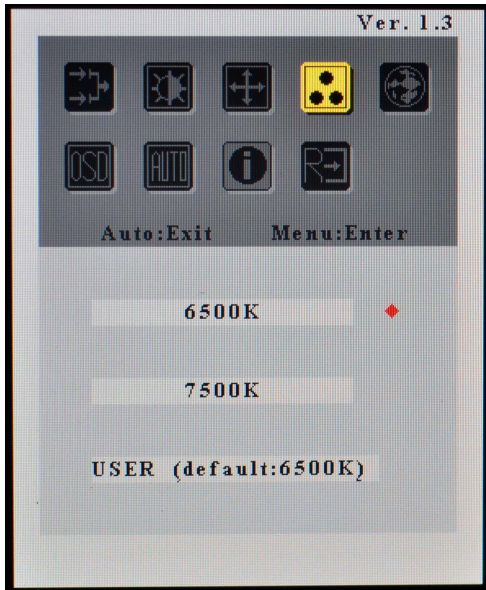

Figure 9 Color temperature screen

The fourth icon on the top row provides access to the color temperature. A red dot indicates the currently selected temperature.

Use the “Up” and “Down” buttons to highlight the desired setting and then press the “Auto/Exit” button to exit the edit mode.

7.5 Language



Figure 10 Language screen

The right-most icon on the top row provides access to the language settings of the on-screen display screens. The currently selected language is highlighted in yellow.

Use the “Up” and “Down” buttons to highlight the desired language, and then press the “Auto/Exit” button to exit the language screen.

7.6 On-screen display settings

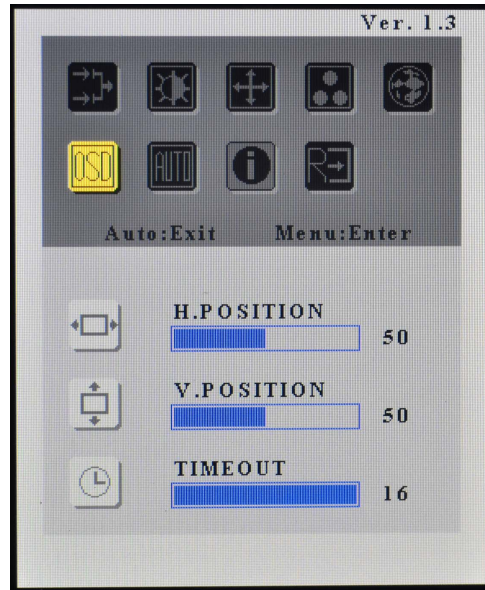

Figure 11 On-screen display settings screen

The first icon on the bottom row provides access to the on-screen display settings position and timeout.

To modify a setting, use the “Up” and “Down” buttons to highlight the desired setting, press the “Menu” button to enter edit mode and use the “Up” and “Down” buttons to change the setting as desired. When finished, press the “Auto/Exit” button to exit the edit mode.

i The timeout value refers to the seconds before the on-screen display closes if no action is taken.

7.7 Automatic configuration



Figure 12 Automatic configuration screen

The second icon on the bottom row provides access to the automatic configuration screen. This tool automatically detects the frequency of the VGA signal and calibrates the display accordingly.

With the icon selected, press the “Auto/Exit” button to activate the configuration. When complete, the screen returns to the initial “connection method” screen.

7.8 Information

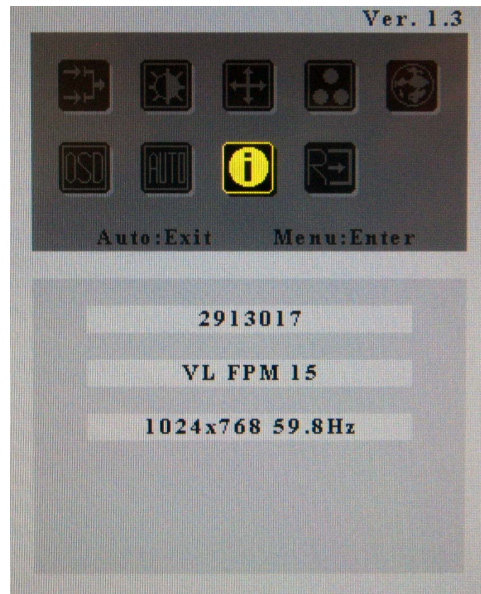

Figure 13 Information screen

The third icon on the bottom row provides information about the resolution and refresh rate of the monitor when operating with a VGA input.

7.9 Memory recall



Figure 14 Memory recall screen

The right-most icon on the bottom row allows the user to reset the display to the factory default settings.