



Midas Touch

magic embedded

We are dedicated to developing sensing technology, and providing customers with an innovative and diverse range of sensor products.

Our sensors and state-of-the art fingerprint recognition algorithm technologies provide advanced and convenient fingerprint acquisition and verification.

MFC-1192 Fingerprint Sensor Datasheet

Midas Touch, Inc.

17F-16, No. 1, Sec. 1, Zhongshan Rd., Banqiao Dist.,
New Taipei City 22063, Taiwan (R.O.C.)

Email: support@midastouchinc.com

Tel : +886-2-8953-0862

Fax : +886-2-2952-8441

[DESCRIPTION]

The MFC-1192 fingerprint image sensor is based on capacitive - touch technology with hardened enhanced ESD strength. The build- in analog and digital circuitries minimize the number of external components, and provide easy to use, standard SPI interface to micro - processors.

The operation of MFC-1192 is as following, a fingerprint image captured by pixel array, delivery fingerprint ridge or valley signals to A/D converter and digital processor, then to the serial peripheral interface for data-reading. The image quality of MFC-1192 can be adjusted by setting gain, offset and reference voltage parameters internally. In addition, the internal operation parameters and interface speed can also be configured to meet various finger conditions.

[SPECIFICATIONS]

Item	Value
Spatial resolution	508dpi
Sensing area	9.6mmx 12.8mm
Package size	12mm x 17.5mm x 1.0mm
Package	RoHS compliant and low - halogen
Supply voltage (Normal operating at 3.3V)	2.6V ~ 3.6V
Total supply current	8.8mA
Standby current	2.1mA
Operating temperature	-20 to +70 °C
ESD protection for air discharging	+/-15kV/ IEC61000-4-2
Inter face	SPI
Frame rate	19

[FEATURES]

- 192x256 pixels
- Build-in ADC for digitizing image
- High speed SPI interface
- Data encryption
- Short read out time
- Cost effective sensor
- High sensing capability
- Single power supply
- IP 67 approved

[APPLICATIONS]

- Door lock
- Security device
- Access control system



Table of Contents

1	Architecture	5
1.1	Block Diagram.....	5
2	Pin Assignment.....	6
2.1	Pin Assignment.....	6
2.2	Pin Description.....	7
2.3	Reference Schematic.....	8
3	Electrical Characteristics	9
3.1	Operation condition	9
3.2	Maximum rating.....	9
3.3	DC Characteristics	10
3.4	SPI Interface	11
3.4.1	Protocol.....	11
3.4.2	SPI Timing Parameters.....	12
3.5	SPI Commands and Registers.....	13
3.5.1	SPI Commands.....	13
3.5.2	SPI Command Detail	13
3.5.3	SPI Command Protocol.....	15
3.6	Sensor Register Table.....	17
3.6.1	Register Details	18
3.7	Sensor Function Description.....	26
3.7.1	Rest.....	26
3.7.2	Analog Finger Detection/Interrupt (Sleep Mode)	26
3.7.3	Digital Finger Detection mode/Interrupt (Standby mode)	26
3.7.4	In Scan line Digital Finger OFF Detection Mode and Interrupt.....	27
3.7.5	INT_FG_ON finger ON/OFF Waveform	27
3.7.6	Timing considerations	28
4	Software Programming.....	29
4.1	Programming Flow	29
4.2	OTP memory map.....	31
5	Package Information.....	34



- 6 Reliability test.....35
 - 6.1 ESD immunity.....35
 - 6.2 Environmental limits.....35
 - 6.3 Mechanical Durability.....36
 - 6.3.1 PENCIL HARDNESS TEST36
 - 6.3.2 CROSS CUT TEST.....37
 - 6.3.3 RCATEST.....38
 - 6.3.4 ALCOHOL ABRASION TEST.....39
- 7 Revision history.....40

Confidential



1 Architecture

1.1 BlockDiagram

The operation of MFC-1192 is as following, fingerprint image captured by pixel array, pass fingerprint ridge or valley signals to A/D converter, digital processor and to the serial peripheral interface. The image quality of MFC-1192 can be adjusted by setting gain, offset and reference voltage parameters internally. In addition, the internal operation parameters and interface speed can also be configured to meet various finger conditions.

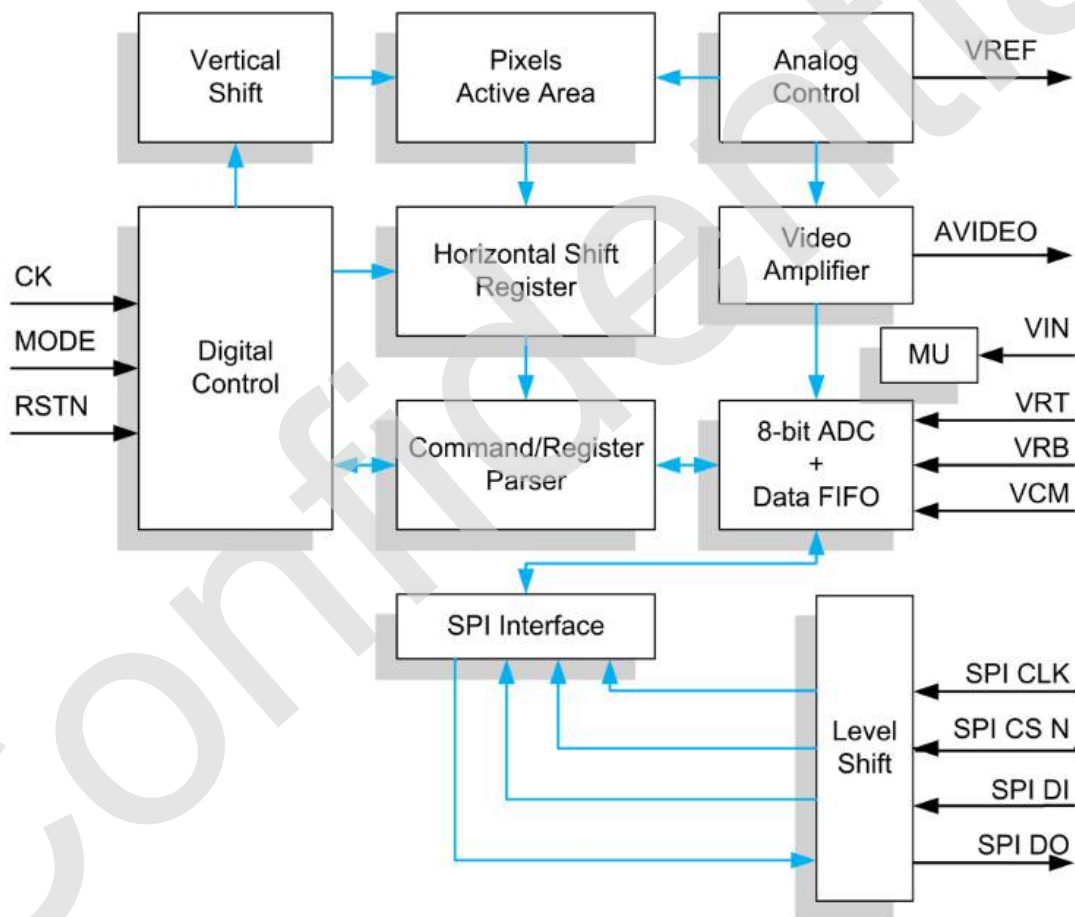



2 Pin Assignment

2.1 Pin Assignment

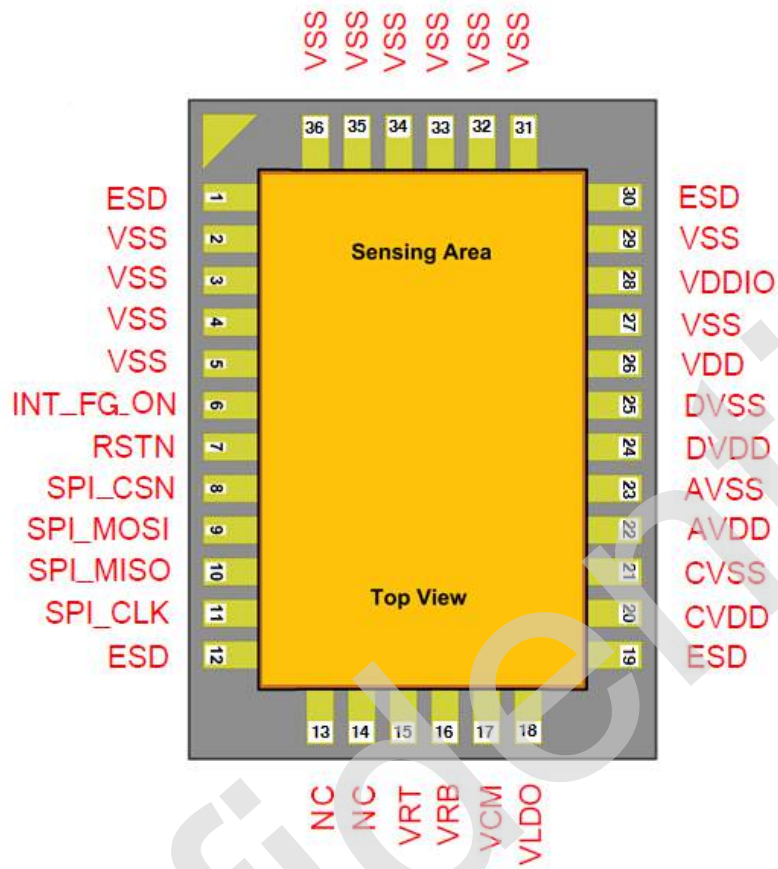

+



2.2 Pin Description

Pin Name	Type	Pin Description	
	Group1		
SPI_MISO	10	Output	SPI data out pin, master in slave out.
SPI_MOSI	9	Input	SPI data in pin, master out slave in.
RSTN	7	Input	A LOW on this pin resets the sensor to take on its default states.
SPI_CSN	8	Input	Chip select for SPI.
VSS	2, 3, 4, 5, 27, 29, 31, 32, 33, 34, 35, 36	Power	Ground.
AVSS	23	Power	Analog ground
DVSS	25	Power	Digital ground
CVSS	21	Power	Analog ground
INT_#ON	6	Output	Standby mode finger detection interrupt pin. Use to wake up host processor.
VDDIO	28	Power	System power. Internally connect to VDD
VDD	26	Power	System power.
DVDD	24	Power	Digital system power
AVDD	22	Power	Analog system power
CVDD	20	Power	Analog system power
ESD	1, 12, 30, 19	ESD	Connect ESD pin to Ground
SPI_CLK	11	Input	The SPI clock rate provided by the master must not exceed 18MHz depend on different application, SPI CLK should be adjusted for best image quality.
VCM	17	Output	Internal Reference voltage output.
VRB	16	Output	Internal Reference voltage output.
VRT	15	Output	Internal Reference voltage output.
VLDO	18	Output	LDO output power, internal use.



2.3 Reference Schematic

MFC-1192 Reference Circuit

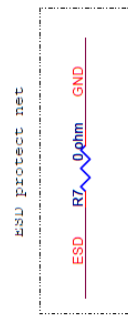
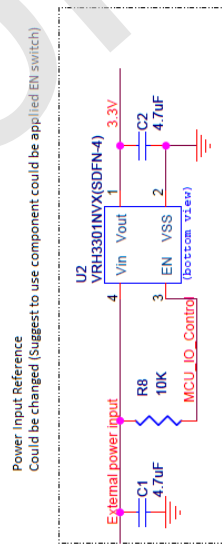

SF519 package pinout

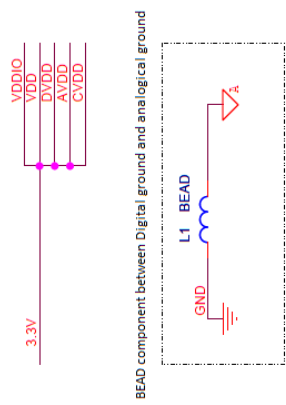
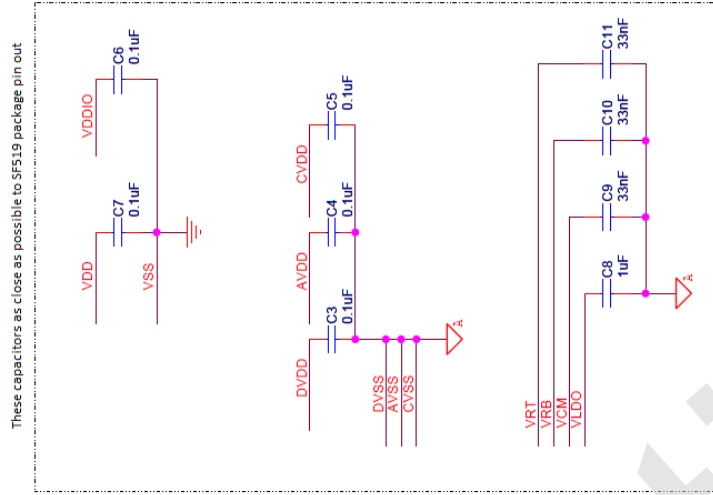
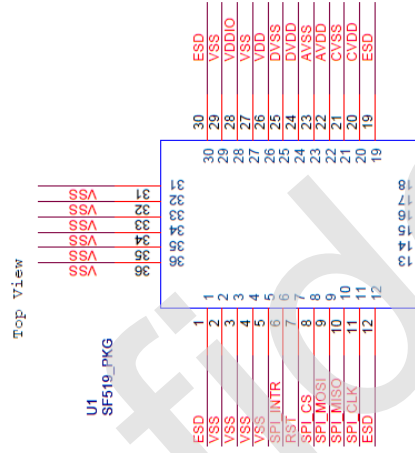



3 Electrical Characteristics

3.1 Operation condition

1	Parameter	Conditions	Min.	Typ	Max	Unit
VDD	Supply voltage		2.6	3.3	3.6	V
IDD	Total supply current	VDD=3.3 V		8.8		mA
IDD	Supply current (CLK = 18MHz)	Standby mode		2.1		mA
ESD	ESD protection	Air mode		15		KV

3.2 Maximum rating

Symbol	Parameter	Conditions	Value	Unit
VDD	Supply voltage		-0.3 to 4	V
V _{I1}	Input pin voltage 1 (SPI _{CLK} , SPI _{MOS} , SPI _{CSn})	(Note1)	-0.3 to V _{DD} +0.3	V
V _{I2}	Input pin voltage 2 (RST _n)	(Note2)	-0.3 to V _{DD} +0.3	V
V _{O1}	Output pin voltage 1 (INT _n , SPI _{MISO})		0.3V to V _{DD} +0.3V	V
TA	Operating temperature		-20 to 70	°C
ST	Storage temperature		-40 to 85	°C
PT ₁₀	Soldering temperature (10 seconds)		250	°C
PT ₁₂₀	Soldering temperature (2 minutes)		183	°C

Note 1: Each Input and Output pin has internal ESD protection diode between pin and VDD.

Note 2: V_{I2} has internal pull high current of 100 μA.



3.3 DC Characteristics

Symbol	Parameter	Conditions	MIN	TYP	MAX	Unit
Digital inputs						
V_{IH}	High level input voltage		$0.8 \cdot V_{DD}$			V
V_{IL}	Low level input voltage				$0.2 \cdot V_{DD}$	V
I_{IH}	High level input current				1	μA
I_{IL}	Low level input current				1	μA
C_i	Input capacitance			5		pF
Digital outputs						
V_{OH}	High level output voltage	$I_{OH} = 0.25mA$		$0.8 \cdot V_{DD}$		V
V_{OL}	Low level output voltage	$I_{OL} = 0.25mA$		0.2	0.5	V



3.4 SPI Interface

3.4.1 Protocol

General SPTiming

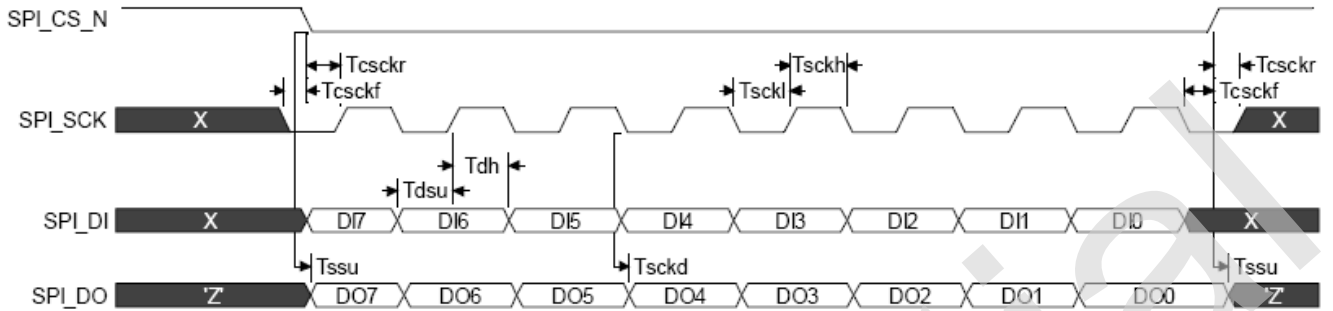

Instruction without return data

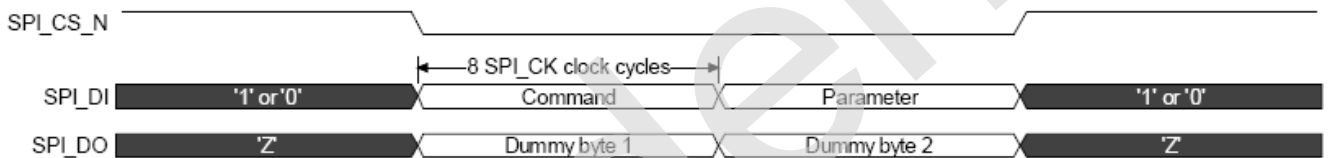

Instruction with return data

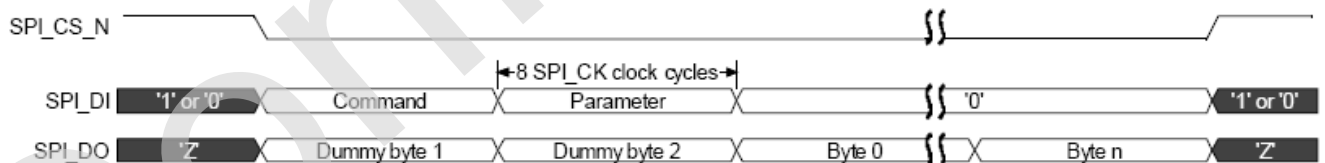

Terminating read by applying a new command

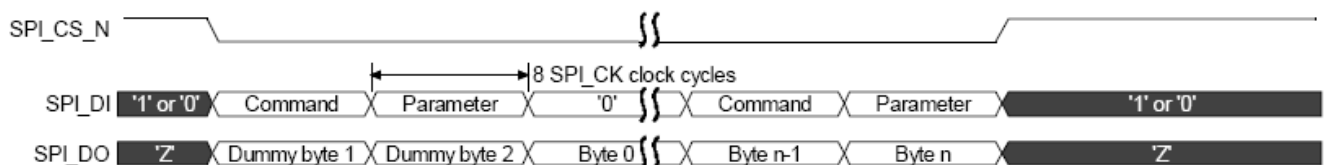



3.4.2 SPI Timing Parameters

Symbol	Parameter	Note	Min.	Typical	Max.	Units
f_{CK}	Clock frequency	1		8	18	MHz
t_{RST}	Reset time	1	50			ns
t_{RD}	Rise time for digital inputs	2			2	ns
t_{FD}	Fall time for digital inputs	2			2	ns
f_{SPI_SCK}	Frequency for SPI clock.	1	0		f_{CK}	MHz
t_{SCKL}	Part of SPI_CLK clock period, during which SPI_CLK is low.	1	23			ns
t_{SCKH}	Part of SPI_CLK clock period, during which SPI_CLK is high.	1	23			ns
t_{CSCKF}	Time from falling edge on SPI_CLK to edge on SPI_CS_N	1	8			ns
t_{CSCKR}	Time from edge on SPI_CS_N to rising edge on SPI_CLK	1	8			ns
t_{DSU}	Setup time for data before rising edge of SPI_CLK	2	6			ns
t_{DH}	Hold time for data after rising edge of SPI_CLK	2	6			ns
t_{SCKD}	Delay from falling clock to data available.	2	1		3	ns
t_{SSU}	Delay from SPI_CS_N low to SPI_DI mode change.	2	1		3	ns

Note 1: Estimated value

Note 2: Simulated value



3.5 SPI Commands and Registers

3.5.1 SPI Commands

Send commands and set control registers through the SPI interface to control the operation. The SPI interface follows the SPI protocol with CPHA=0 and CPOL=0 as SPI mode 0. The sensor only can support SPI mode 0 operation.

These 6 command codes program the chip:

Command Code	Name	Function	Read/Write
0x01	RDATA	read pixel data	R
0x02	START	start scan	W
0x03	STATUS	read status	R
0xC0	SRST	software reset	W
0x20+N	RREAD	read register	R
0x40+N	RWRITE	write register	W

For the register read and write commands, the number N is the register address. The effective N is in the range of 0x00 to 0x1F.

3.5.2 SPI Command Detail

Code 01 / RDATA command (read only)

- This command pumps image data from FIFO and sends it to the host.

Code 02 / START command (write only)

- This command starts the fingerprint image scan.

Code 03 / status read command (read only)

- This command sends the 8-bit internal status flags to the host.
- The status flags are defined as below



Bit	Function
0	Data FIFO is “half full”
1	Data FIFO is empty
2	Data FIFO is “almost full”
3	Data FIFO is full
4	Image scan active
5	Detect interrupt flag
6	Detect result is OK
7	(not used)

Code 0xC0 / SRST command (write only)

- This command generates a software reset to the system. Its effect is the same as a hardware reset except that the register content is left unchanged.

Code 0x2N / register read command

- This command starts reading the register at address N.
- At least two bytes need to be written, the first byte is the command code, and the second (dummy) byte is for the register content.
- Subsequent register read commands can be cascaded in one command sequence.

Code 0x4N / register write command

- This command starts writing registers starting at address N.
- The first byte is the command code, followed by subsequent bytes that are written to registers starting at the specified starting address N.

All command code as the first byte in a command sequence returns the state byte (which can be explicitly read by the 03 command).



3.5.3 SPI Command Protocol

Command and data are exchanged through the SPI MISO and MOSI wires. Each byte of data sent through the MOSI port brings back a received byte through the MISO port.

Commands can be cascaded one after another. The term “SPI command sequence” in the following context is defined as a sequence of command code and data bytes exchange within one active SPISEL strobe.

A command code may or may not have associated data. The “start scan” and “software reset” commands don’t have associated data, and take effect immediately after the command code is sent.

For read/write data commands, the second byte will be the beginning of the data byte or bytes, as illustrated below:

- read command



- write command

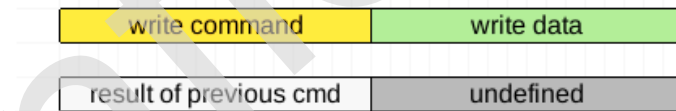

Writing and reading a series of register content may look different. For writing to consecutive registers, an internal address counter is incremented automatically after each byte written. This design eliminates the need to repeat sending the 0x40+N command for each byte. So the sequence of read/write commands may look like the following:

- read sequence (the last command byte is a dummy command)

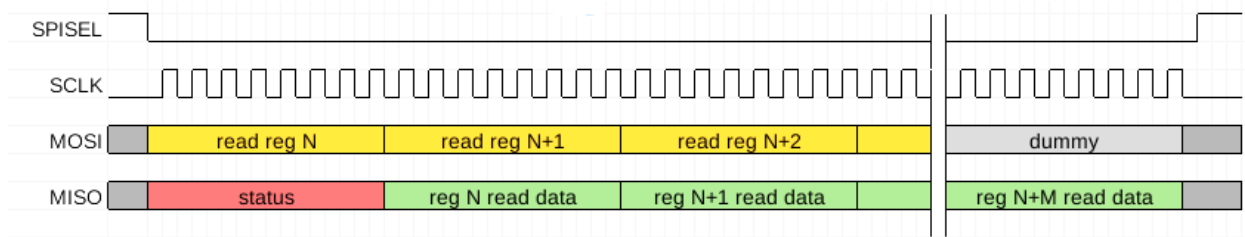



- write sequence

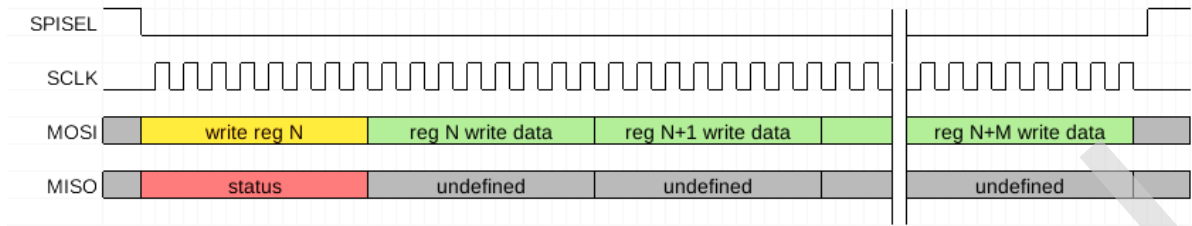

- read image sequence

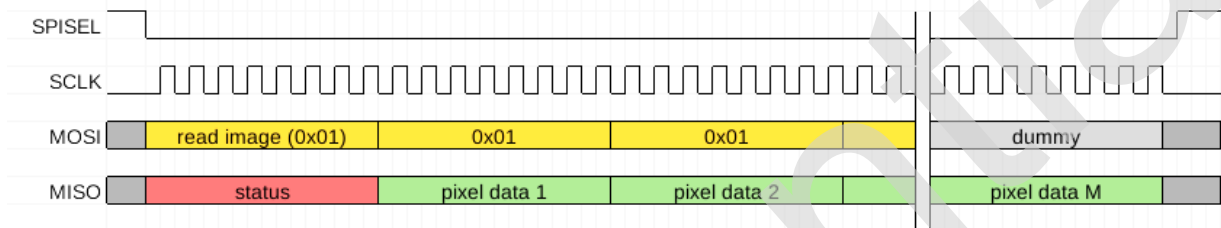

In fact, except for the write register command (which writes a sequence of register content), commands can be mixed in a single sequence like the following:

- mixed mode of read image and status sequence

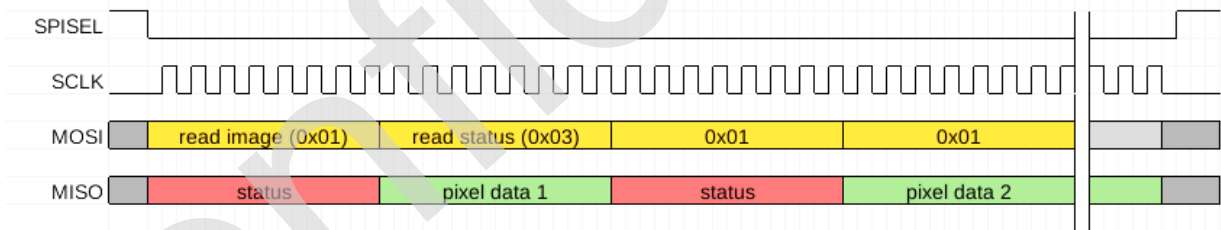



3.6 Sensor Register Table

The following table summarizes the register content:

MFC-1192 Register Table

N	Address	Name	Function	RW	HW Reset Default	7	6	5	4	3	2	1	0		
0	0x00	reg_clk	clock control	RW	0								div_opclk		
1	0x01	reg_pag	pag control	RW	0	pga2_gain								pga1_gain	
2	0x02	reg_dcoc	dc offset	RW	0								dc_offset		
3	0x03	reg_adc	adc setting	RW	0	adc_bias				adc_vrt		adc_yrb			
4	0x04	reg_otp_addr	OTP address	RW	0	tdac[9:8]		otp_addr							
5	0x05	reg_otp_wdat	OTP write data	RW	0	tdac[7:4]				otp_bit					
6	0x06	reg_otp_ctrl	OTP control	RW	0	tdac[3:0]				otp_din	otp_prg	otp_rst	otp_ceb		
7	0x07	reg_otp_rdat	OTP read data	R									otp_rdat		
8	0x08	reg_deth	finger detection threshold	RW	0xFF								deth		
9	0x09	reg_ddiv	clock divider for detection	RW	0								ddiv		
10	0x0A	reg_enab	function enable bits	RW	0	en_window	en_inscan	en_det				en_osc	en_ana_fpdet	en_analog	
11	0x0B	reg_mode	mode control bits	RW	0	chip_en	intr_en								
12	0x0C	reg_llx	windowing function setting	RW	0								llx		
13	0x0D	reg_lly	windowing function setting	RW	0								lly		
14	0x0E	reg_urx	windowing function setting	RW	0xBF								urx		
15	0x0F	reg_ury	windowing function setting	RW	0x7F								ury		
16	0x10	reg_chmd	change mode	W	(N/A)								ch_mode		
17	0x11	reg_inscanline	in scan, detection line number	RW	0x3F								in_scan_line		
18	0x12	rg_indeteline	in detect, detection line number	RW	0x40								in_dete_line		
19	0x13	rg_analog_rosc	analog rosc	RW	0x20								analog_rosc		
20	0x14	Reserve		RW	0x01										
21	0x15	Reserve		RW	0x00										
22	0x16	Reserve		RW	0xDF										
23	0x1D	Reserve		RW	0x00										
24	0x1E	Chip_ID_H	high byte of Chip ID	R	0xA5										
25	0x1F	Chip_ID_L	low byte of Chp ID	R	0x19										



3.6.1 Register Details

Register Name	Addr	R/W	Bit(s)	Default	Description
REG_CLK	0	R/W		0000_0000	Clock control
			[7:6]		Reserve
			[5:4]		Reserve
			[3:0]		DIV_OPCLK The 4-bit DIV_OPCLK value (0~15) is the divider defining the ratio between the system clock (OSC) and opclk: $opclk_freq = sysclk_freq / (DIV_OPCLK + 1)$
REG_PGA (* Note 1)	1	R/W		0100_0000	PGA Gain Control
			[7:4]		PGA2_GAIN For the gain control of PGA2 $PGA2\ gain = PGA_gain * [(V_{in_pga} - V_{in_n_pga}) + V_{off}] / [2 * (VRT - VRB)] * 255$
			[3]		Reserve
			[2]		Reserve
			[1:0]		PGA1_GAIN 00 : 2.00 01 : 2.67 10 : 4.00 11 : 8.00
REG_DCOC (* Note 2)	2	R/W		0000_0000	DC_OFFSET - DC offset control of PGA2
			[7]		Sign bit 0 : negative 1 : positive
			[6:0]		Offset compensated voltage The DC offset voltage is set as the following formula: $V_{off} = 0.4545 * (2 * B7 - 1) * [<B6:B0> / 128 * (VRT - VRB) + Vos1]$ $Vos1 \sim N(\mu1, \sigma1)$ normal distribution, $\mu1 = 0$ & $\sigma1 \sim 3.5mV \sim 5mV$
REG_ADC	3	R/W		0010_0101	Adc setting
			[7]		Not used
			[6:4]		ADC_BIAS ADC bias current settings 000 : 8uA 001 : 12uA 010 : 16uA (default)



Register Name	Addr	R/W	Bit(s)	Default	Description
					011 : 20uA 1xx : 24uA
			[3:2]		ADC_VRT
					(VRT -VRB) settings: 00 : 0.90V 01 : 1.05V (default) 10 : 1.20V 11 : 1.35V
			[1:0]		ADC_VRB
	VRB settings: 00 : 0.800V 01 : 0.844V (default) 10 : 0.933V 11 : 0.978V				
REG_OTP_A DDR	4	RW		0000_0000	OTP address
					TDAC[9:8]
			[7:6]		DC offset coarse trim setting bit[9:8] All sensors may not have the same register setting in this field When increase this register value, the gray scale of image background become darker.
			[5]		Not used
			[4:0]		OTP_ADDR Byte address
REG_OTP_ WDAT	5	RW		0000_0000	OTP write data
					TDAC[7:4]
			[7:4]		DC offset coarse trim setting bit[7:4] All sensors may not have the same register setting in this field.
			[3:1]		Reserve
			[0]		Reserve
REG_OTP_ MODE	6	RW		0000_0000	OTP control
					TDAC[3:0]
			[7:4]		DC offset coarse trim setting bit[3:0]



Register Name	Addr	R/W	Bit(s)	Default	Description
					All sensors may not have the same register setting in this field.
			[3]		Reserve
			[2]		Reserve
			[1]		Reserve
			[0]		Reserve
REG_OTP_RDAT	7	R			OTP read data
			[7:0]		OTP_RDAT OTP read data
REG_DETH	8	RW		1111_1111	Detection threshold
			[7:0]		DETH Finger detection threshold value The value is the maximum large byte of accumulation value of detection line total pixel gray scale value. The maximum value is 0xFF.
REG_DDIV	9	RW		0000_0000	Clock divider for detection interval
			[7:0]		DDIV A clock divider for finger detection interval The detection scan timing period(detint) is given by: finger detect clock (dclk): $dclk = (1000 * oscclk) / 4096$ $detint = 1 / (dclk / (ddiv + 1))$ mS for example: oscclk = 18 Mhz, ddiv = 144 (0x90) $dclk = (1000 * 18Mhz) / 4096 = 4.395kHz$ $detint = 1 / (4.395kHz / (144 + 1)) = 33mSec$
REG_ENAB	A	RW		0000_0000	Enable bits
			[7]		EN_WINDOW Enable windowing function The windowing size is assigned by reg_llx, reg_lly, reg_urx and reg_ury (0x0C~0x0F)



Register Name	Addr	R/W	Bit(s)	Default	Description	
					0 : Disable 1 : Enable	
			[6]		EN_INSCAN_DET	Enable the in scan line detectionfunction The finger detection scan line can be changed according to the value of reg_inscanline (0x11) if enable
						0 : Disable 1 : Enable
			[5]		EN_DET	Enable the standby finger detection mode
						0 : Disable 1 : Enable
			[4]			Reserve
			[3]			Reserve
			[2]		EN_OSC	Enable internal clock oscillator
						0 : Disable 1 : Enable
			[1]			Reserve
			[0]		FORCE_EN_ANALOG	Force to enable analog circuitat all time. When set to 0, at standby mode finger detection phase, the analog logic will be open automatically only when finger detection period start. It can reduce power consumption at standby mode.
						0 : Disable 1 : Enable
			REG_MODE	B	RW	
[7]		CHIP_EN				Chip enable bit
						0: Disable 1: Enable
[6]		INTR_EN				Enable standby mode fingerdetection interrupt
			0 : Disable 1 : Enable			



Register Name	Addr	R/W	Bit(s)	Default	Description
			[5:0]		Not used
REG_LLX	C	RW		0000_0000	Windowing function position setting
			[7:0]		LLX Windowing is a flexible function that lets you read the image data within the 192 x 256 pixel size according to your need. The windowing size is assigned by 4 registers, REG_LLX, REG_LLY, REG_URX and REG_URY. Refer to the following figure for how to set the windowing position and size. Range of REG_LLX are ≥ 0 and $\leq 0xBF$
<p>Formula of windowing size: $X_l = 191 - \text{REG_URX}$ $Y_l = 255 - (2 * \text{REG_URY} + 1)$ (even only) $X_u = 191 - \text{REG_LLX}$ $Y_u = 255 - (2 * \text{REG_LLY})$ (odd only)</p> <p>REG_LLX = $191 - 143 = 48$ (0x30) REG_LLY = $(255 - 143) / 2 = 56$ (0x38) REG_URX = $191 - 31 = 160$ (0xA0) REG_URY = $((255 - 32) - 1) / 2 = 111$ (0x6F)</p>					
REG_LLY	D	RW		0000_0000	Windowing function position setting
			[7:0]		LLY Refer to REG_LLX for details. Range of REG_LLY are ≥ 0 and $\leq 0x7F$
REG_URX	E	RW		1111_1111	Windowing function position setting
			[7:0]		URX Refer to REG_LLX for details. Range of REG_URX are ≥ 0 and $\leq 0xBF$
REG_URY	F	RW		1011_0011	Windowing function position setting
			[7:0]		URY Refer to REG_LLX for details. Range of REG_URY are ≥ 0 and $\leq 0x7F$
REG_CHMD	10	W			Change mode
			[7:1]		Not used
			[0]		CH_MODE Change mode for switching mode.



Register Name	Addr	R/W	Bit(s)	Default	Description
					Whenever the detection mode control bit REG_MODE (0x0B) bit 6 is turned on or off, it is required to write (any value) to the REG_CHMD (REG 0x10) register to inform the internal logic to change the scan geometry.
REG_INSCANLINE	11	RW		0100_0000	Set in scan detection finger detection line number
			[7:0]		INSCANLINE_NUMBER In scan line number value. The limitation is 0~0x7F, or Y axis range when you enable the windowing function. $Y_{scan\ line} = 2 * REG_INSCANLINE$ $Y_{scan\ line}$ is even only. For example: Suppose want to use 80 th line as in scan detection line. Value of Reg0x11 = $80/2 = 40$
<p>The diagram shows a rectangular scan area with a width of 192 units and a height of 256 units. The origin (0,0) is at the bottom-left corner. The top-right corner is at (191,255). A green 'Window Of interest' is centered within the scan area, with its bottom-left corner at (X_L, Y_L) and its top-right corner at (X_U, Y_U). A red horizontal line represents the 'In scan finger detection line', which is labeled as REG_INSCANLINE. A dashed arrow points from the text 'In scan finger detection line : REG_INSCANLINE' to this red line.</p>					
REG_INDETLINE	12	RW		0101_0000	Set finger detection line number of standby mode
			[7:0]		INDETLINE_NUMBER $Y_{det\ line} = 255 - 2 * REG_INDETLINE$ $Y_{det\ line}$ is odd only. Exp: When want to use 5th line as detection line. The register value is $(255 - 5)/2 = 125$
REG_ANALOG_OSC (*Note3)	13	RW		0010_0000	Internal RLC oscillator setting
			[7:6]		Not used
			[5:1]		ANA_TRIM_OSC Suggest default value is 0x08, Frequency is about 18MHz. The variance of frequency is $\pm 10\%$. Detail frequency table refer to Note3.
			[0]		Should set to 0.



Register Name	Addr	R/W	Bit(s)	Default	Description
	15	RW		0000_0000	Reserve. Should be 0x00.
	16	RW		1101_1111	Reserve. Should be 0x00.
	1D	RW		0000_0000	Reserve. Should be 0x 00.
REG_ID_H	1E	R		1010_0001	Sensor Chip ID number high byte
			[7:0]		Value is 0xA 5.
REG_ID_L	1F	R		0000_0101	Sensor Chip ID number low byte
			[7:0]		Value is 0x19.

■ *Note 1:

The total gain ratio of Gain1 * Gain2 are as following table.

			Gain1 Ratio				
			DEC	0	1	2	3
			HEX	0	1	2	3
Gain2 Ratio	DEC	HEX	2.00	2.67	4.00	8.00	
	0	0	1.88	3.76	5.03	7.53	15.06
	1	1	3.56	7.11	9.49	14.22	28.44
	2	2	3.76	7.53	10.05	15.06	30.12
	3	3	4.00	8.00	10.68	16.00	32.00
	4	4	4.27	8.53	11.39	17.07	34.13
	5	5	4.57	9.14	12.21	18.29	36.57
	6	6	4.92	9.85	13.14	19.69	39.38
	7	7	5.33	10.67	14.24	21.33	42.67
	8	8	5.82	11.64	15.53	23.27	46.55
	9	9	6.40	12.80	17.09	25.60	51.20
	10	A	7.11	14.22	18.99	28.44	56.89
	11	B	8.00	16.00	21.36	32.00	64.00
	12	C	9.14	18.29	24.41	36.57	73.14
	13	D	10.67	21.33	28.48	42.67	85.33
	14	E	12.80	25.60	34.18	51.20	102.40
15	F	16.00	32.00	42.72	64.00	128.00	

■ *Note 2:

The MSB bit 7 is a sign bit which compensate from positive to negative. The register value correspond to finger print image gray scale value is showin following pictures.

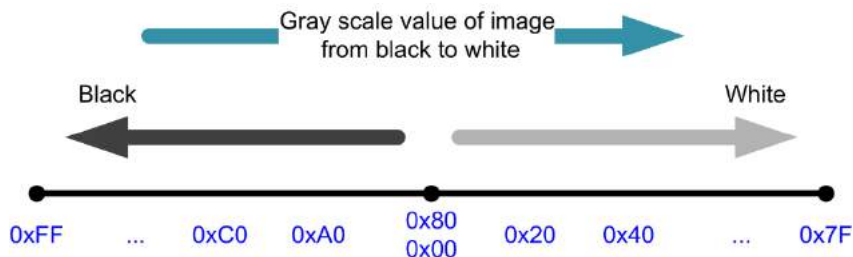



■ *Note 3:

The value of analog_osc to frequency table is as following.

REG_ANAL OG_OSC	Frequency (MHz)	REG_ANAL OG_OSC	Frequency (MHz)
0x00	23.66	0x02	15.52
0x20	20.70	0x22	14.05
0x10	20.47	0x12	13.95
0x30	18.15	0x32	12.75
0x08	19.47	0x0A	13.45
0x28	17.33	0x2A	12.31
0x18	17.16	0x1A	12.23
0x38	15.45	0x3A	11.28
0x04	17.86	0x06	12.60
0x24	16.01	0x26	11.58
0x14	15.87	0x16	11.51
0x34	14.36	0x36	10.66
0x0C	15.30	0x0E	11.21
0x2C	13.88	0x2E	10.38
0x1C	13.77	0x1E	10.33
0x3C	12.60	0x3E	9.63

*Variance is ±10%.



3.7 Sensor Function Description

3.7.1 Reset

Three sources of reset can force the chip to enter reset state (this disables all internal logic)

- the hardware reset pin
- the SPI software reset command
- the reset caused by the content of REG_MODE (Rreg0x0B) register chip_en bit.

However only the hardware reset pin can reset the internal SPI state machine.

3.7.2 Digital Finger Detection Mode/Interrupt (Standby Mode)

The finger present detection function is enabled by setting the Reg0x0A/REG_ENAB bit 5 en_det to 1. Finger detect interrupt is enabled by setting the Reg0x0B/REG_CHMD bit 6 en_intr to 1. The interrupt hardware output is NT_FG_ON pin .

In finger detection mode, the hardware logic periodically scans the rows assigned by REG_INDETETLINE of the pixel array. Instead of sending pixel data to FIFO, the pixel data bytes are summed up and compared with a threshold value (determined by the Reg0x08/REG_DETH) at the end of the line. If the sum is greater than the content of REG0x08, then the interrupt flag will be raised.

Once the “Detect result is OK” status bit or “finger detected” interrupt flag is raised, the internal image channel will be opened to allow full image data to be transferred to the MCU.

If at the end of the detection scan, the summed pixels are less than the threshold value, the interrupt flag will be set to (or return to) 0, and the image data channel will be closed.

There are two status bits in the status register associated with the detection mode:

- Status.bit5 is the detection interrupt flag, which is set at the end of each detection scan, and cleared whenever a new scan (either image scan or detection scan) is started.
- Status.bit6 is the detection OK flag, which is only set or cleared at the end of a detection scan. This bit is used to enable or disable the image channel.
- Both bit5 and bit6 are cleared by reset.



3.7.4 In Scan line Digital Finger OFF Detection Mode and Interrupt

MFC-1192 has a detection function to detect finger OFF status which is in scan line detection function. The mechanism is the same as standby mode finger present detection mechanism to detect one dedicated line which assigned by Reg0x11/REG_INSCANLINE. If the pixel data sum up value lower the threshold value which set by Reg0x08/REG_DETH, it implies the finger lift up from sensor surface and the whole white lines are output after the in scan line number. The rising edge interrupt signal will output to pin INT_FG_ON if Reg0x0B/REG_MODE bit 6 en_intr is set to 1. The status.bit5 and bit6 are also become 0 after finger departure.

3.7.5 INT_FG_ON finger ON/OFF Waveform

Following picture is INT_FG_ON pin waveform. The default state is high after enable Reg0x0B/REG_MODE bit 6 en_intr. A falling edge state is present when finger touch which detect by digital finger detection process. A rising edge state is present when finger departure which detected by in scan line detection process.

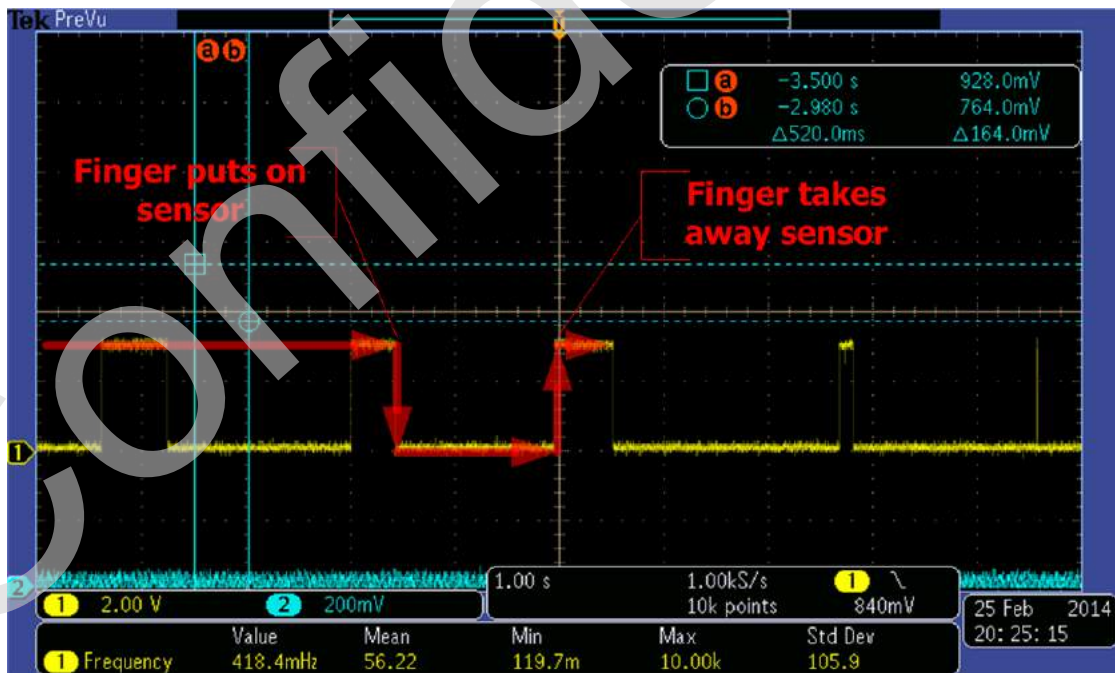



3.7.6 Timing considerations

Keep the following timing parameters in mind for a good estimation of timing:

- Upon power up, reset, or whenever detection mode is turned off, the delay time from sending the startcommand to the first data byte available is about 180 pclk cycles.
- For the subsequent scans, the delay time is reduced to 19 pclk cycles.
- The image sample is taken at the speed of pclk, i.e., one pixel per pclk cycle.
- There is a small delay of 11 pclk cycles between lines

Confidential



4 Software Programming

4.1 Programming Flow

Following picture is sensor operation flow. After MCU do hardware reset, read OTP calibration data and then initialize all register values, the sensor initialization is done and enter idle. When start to capture fingerprint image, it must first enter the finger detection mode (standby mode) and waiting for finger touch on sensor, which be check by status command bit 6 “Detect result is OK” switch to 1 or by INT_FG_ON hardware interrupt pin. After that (Status bit 6 = 1), sensor can enter image scan mode to read out the full image data. If enter image scan mode when status bit 6 “Detect result is OK” is 0, the almost whole white fingerprint image will get.

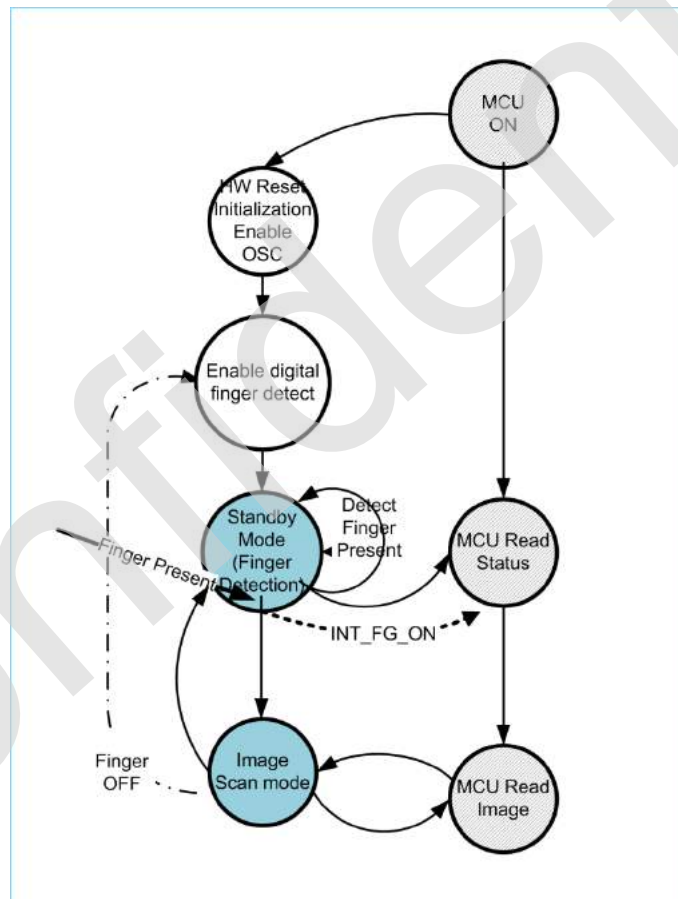

Detail firmware programming flow is provided as following picture. The more detail sample code please refers to iMD SDK.



4 Software Programming

4.1 Programming Flow

Following picture is sensor operation flow. After MCU do hardware reset, read OTP calibration data and then initialize all register values, the sensor initialization is done and enter idle. When start to capture fingerprint image, it must first enter the finger detection mode (standby mode) and waiting for finger touch on sensor, which be check by status command bit 6 “Detect result is OK” switch to 1 or by INT_FG_ON hardware interrupt pin. After that (Status bit 6 = 1), sensor can enter image scan mode to read out the full image data. If enter image scan mode when status bit 6 “Detect result is OK” is 0, the almost whole white fingerprint image will get.

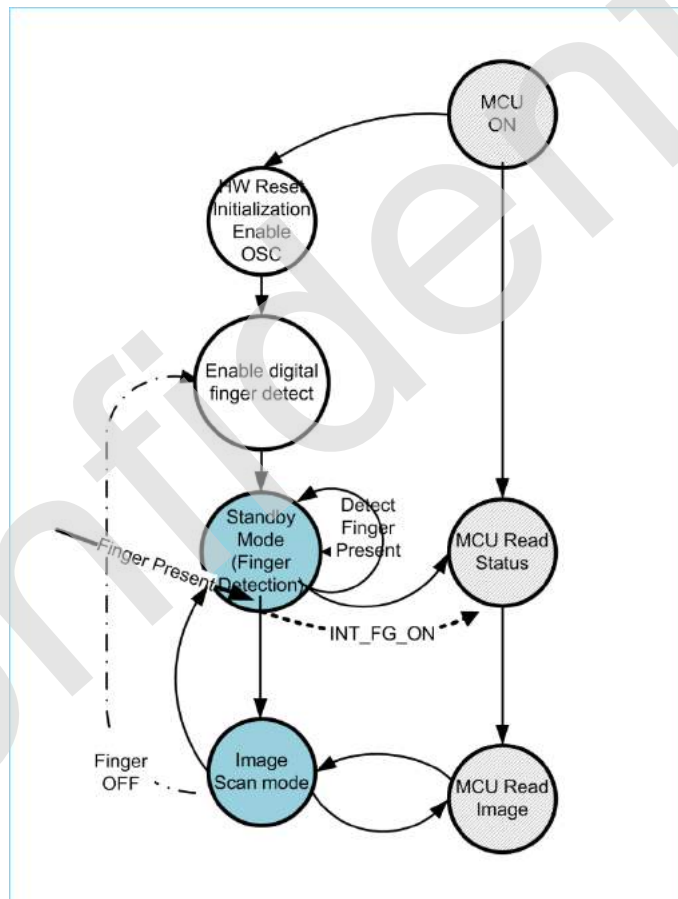

Detail firmware programming flow is provided as following picture. The more detail sample code please refers to iMD SDK.

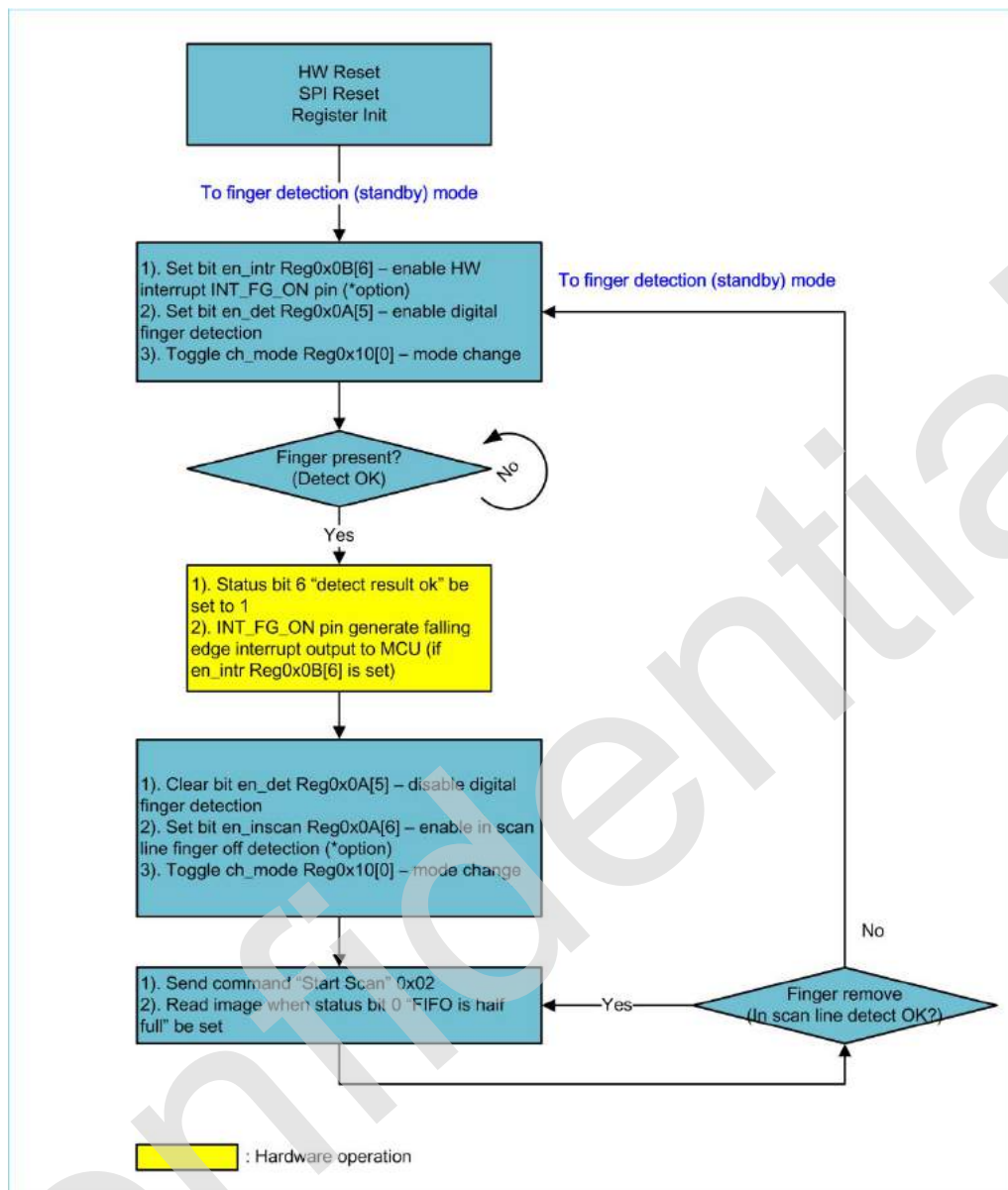



4.2 OTP memory map

4.21 OTP Overview

The MFC-1192 fingerprint sensor has an embedded 32 Byte OTP (One Time Programmable) memory block, made by a simple Electrical Poly Fuse Block.

This OTP memory block only provides some chip calibration data and the serial number. It is not customer-writable.

This section provides the memory map of the OTP memory block, the chip calibration data usage flow and OTP read function sample code.

- ※ The definition of memory map may be changed and please refer to the latest sample code for reference.

4.22 OTP memory map Blocks

OTP is partitioned into 3 blocks. The data in 1st block “Calibration Data Block” should be read out during sensor initialization and apply into register. Please refer to the following picture of “OTP memory map”.

3 sets of Reg0x01 “reg_pag” and corresponding Reg0x02 “reg_dcoc” were calibrated and write into OTP from Byte1 to Byte6.

Byte 7[7:0] and Byte8[3:0] record the register Tdac[9:0] calibration value which should be read out from OTP and set into Reg0x04 tdac[9:8], Reg0x05 tdac[7:4] and Reg0x06 tdac[3:0] accordingly during register initialization phase, too.

The 2nd is chip serial number which is used to record the unique sensor serial number.

The 3rd block is “Calibration Data Extension Block”. The OSC trim data is in Byte19 which also need to readout and set into Reg0x13 [5:0] analog_rosc to provided a precisely sensor clock.



OTP memory map v4

	Addr	Definition
Calibration Data Block	Byte 0	Version
	Byte 1	Reg 0x01 (pga1_gain=3)
	Byte 2	Reg0x02 (dcoffset@pga1_gain=3)
	Byte 3	Reg 0x01 (pga1_gain=2)
	Byte 4	Reg0x02 (dcoffset@pga1_gain=2)
	Byte 5	Reg 0x01 (pga1_gain=1)
	Byte 6	Reg0x02 (dcoffset@pga1_gain=1)
	Byte 7	Tdac[7:0]
	Byte 8	Reserve Tdac[9:8]
	Byte 9	Checksum
Chip Serial Number	Byte 10	Version
	Byte 11	Data00
	Byte 12	Data01
	Byte 13	Data02
	Byte 14	Data03
	Byte 15	Data04
	Byte 16	Data05
	Byte 17	Checksum
Calibration Data Extension Block	Byte 18	Version
	Byte 19	OSC Trim
	Byte 20	OSC Trim Checksum
	Byte 21	Reserve
	Byte 22	Reserve
	Byte 23	Reserve
	Byte 24	Reserve
	Byte 25	Checksum
Reserve Block	Byte 26	Reserve
	Byte 27	Reserve
	Byte 28	Reserve
	Byte 29	Reserve
	Byte 30	Reserve
	Byte 31	Reserve



4.23 Calibration Data Block Programming Flow

The flow of reading and applying the calibration data block in the OTP memory block during the initialization flow is simple as shown in the following figure. One important note is that if you want to finetune the DC offset value to get a more white\gray scale background image, you can choose one fingerprint sensor and calculate the DC-offset difference value to OTP calibration data of Reg0x02. Then apply the DC -offset difference value to the rest of your fingerprint sensors. The final DC-offset value assigned to the register will be described by the following formula.

$$\begin{aligned}
 \text{RegValue(SensorN)}_{\text{apply}} &= \text{RegValue(SensorN)}_{\text{OTP Default Reg}} \\
 &+ (\text{RegValue(SensorA)}_{\text{Refine_tune}} - \text{RegValue(SensorA)}_{\text{OTP Default Reg}})
 \end{aligned}$$

Sensor A: Golden sample sensor for fine -tuning.

Sensor N: All other sensors except sensor A.

To adjust reg0x01 “reg_pga” value is also available and the method to get the corresponding value of reg0x02 “reg_dcoc” is the same as description above. The difference of reg_dcoc is predictable if change reg_pga on the same pag1_gain setting. For example, if calibration data block byte1 is 0xD7 and then want to use the larger gain 0xF7, the corresponding difference of reg_dcoc can be measured by one sensor and apply this difference to all other sensors.

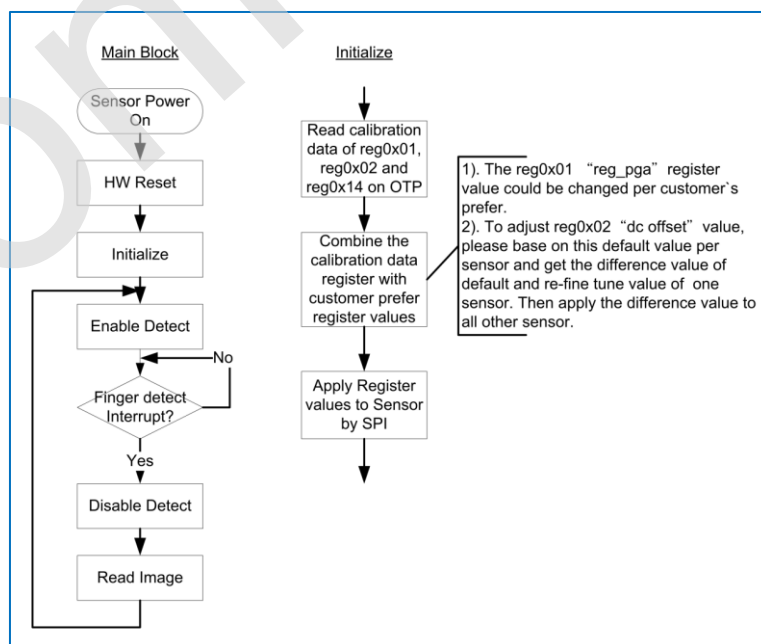



5 Package Information

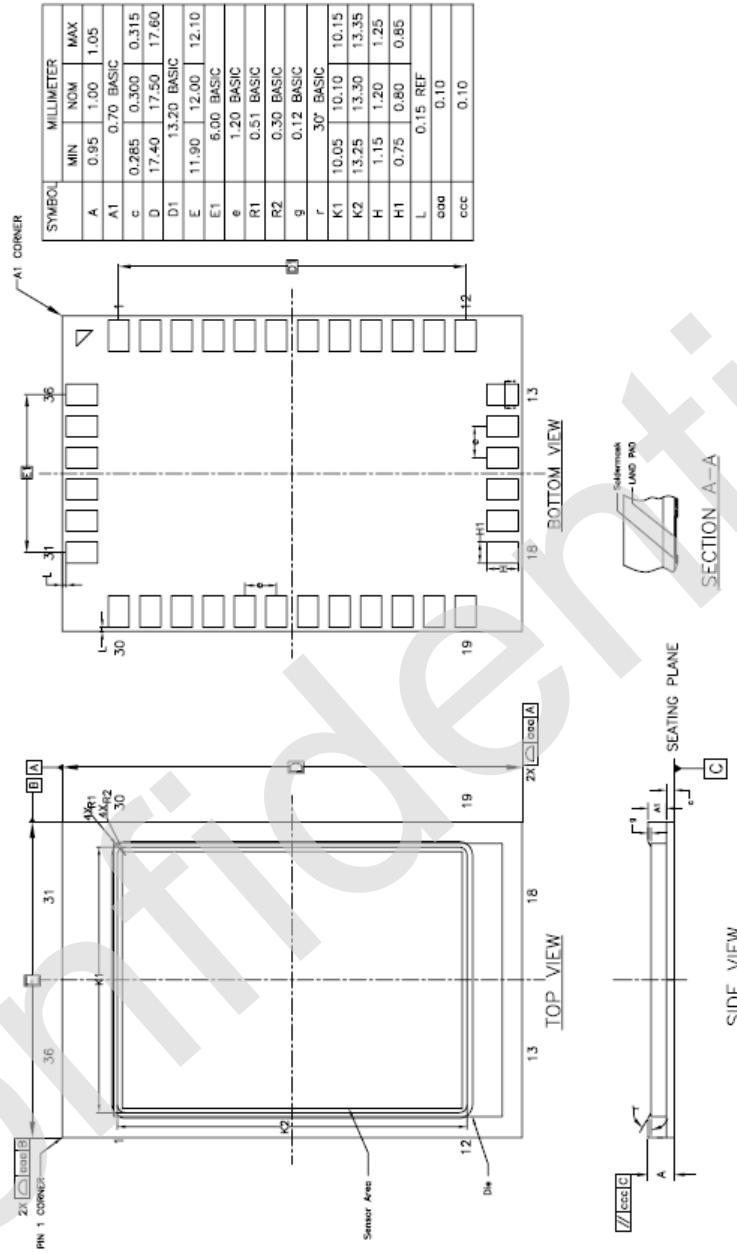



6 Reliability test

6.1 ESD immunity

The packaged sensor fulfills the following requirements with regards to ESD immunity:

Parameter	Reference	Conditions	Value	Units
ESD	IEC61000-4-2	Air discharge	> ±15	KV

This level of ESD immunity is achieved by the combination of a surface coating with the ability to withstand > ±15 kV, a drive frame and a primary drive electrode that leads charge away from the sensor. The length of the internal wiring connecting the drive frame should be minimized to increase the capacity to divert fast ESD-pulses.

6.2 Environmental limits

The sensor chip fulfills the following requirements regarding environmental durability:

Parameter	Reference	Conditions	Normal	Low Limit	Units
Cold operational	JESD22-A108	500H	-20	0	°C
Hot operational	JESD22-A108	1000H	+85	+55	°C
Cold storage	JESD22-A119	168H	-40	-40	°C
Hot storage	JESD22-A103	168H	+85	+85	°C
Temperature cycling	JESD22-A104	30 min/30 min 250 cycles	-40/+85	-40/+85	°C



6.3 Mechanical Durability

The sensor chip fulfills the following requirements with regards to mechanical durability:

6.3.1 PENCIL HARDNESS TEST

LABORATORY AMBIENCE CONDITION

Temperature: $25\text{ }^{\circ}\text{C} \pm 5\text{ }^{\circ}\text{C}$

Relative humidity: $55\% \pm 15\%$ (RH)

TEST CONDITION

Load: 750 gf

Angle: 45 degree

Pencil: Mitsubishi 6H,7H,8H

Test cycles: 1 cycle

SUMMARY OF TEST

Visual inspection of sample surfaces showed no abnormality

Test Equipment

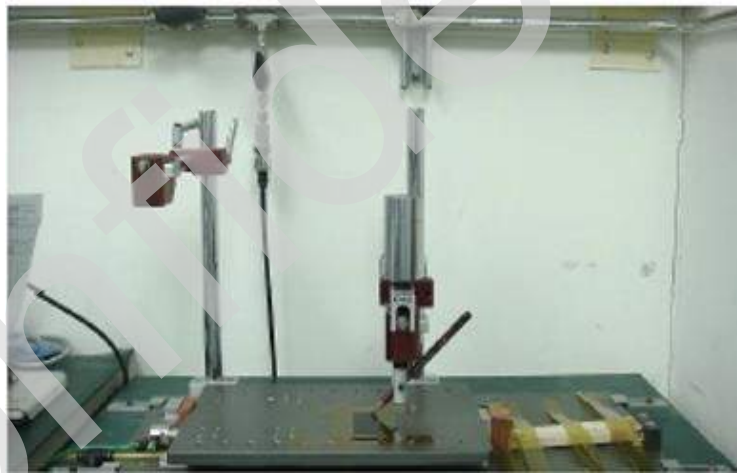

Setup

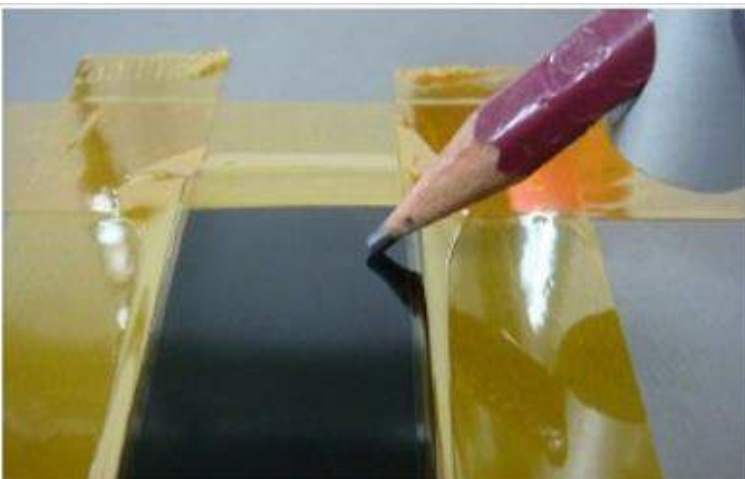



6.3.2 CROSS CUT TEST

LABORATORY AMBIENCE CONDITION

Temperature: $25\text{ }^{\circ}\text{C} \pm 5\text{ }^{\circ}\text{C}$

Relative humidity: $55\% \pm 15\% \text{ (RH)}$

TEST CONDITION

Cutter guide: 1 mm

Tape: 3M-600

Pulling angle: 180°

SUMMARY OF TEST

The test results of judgment by the customer.

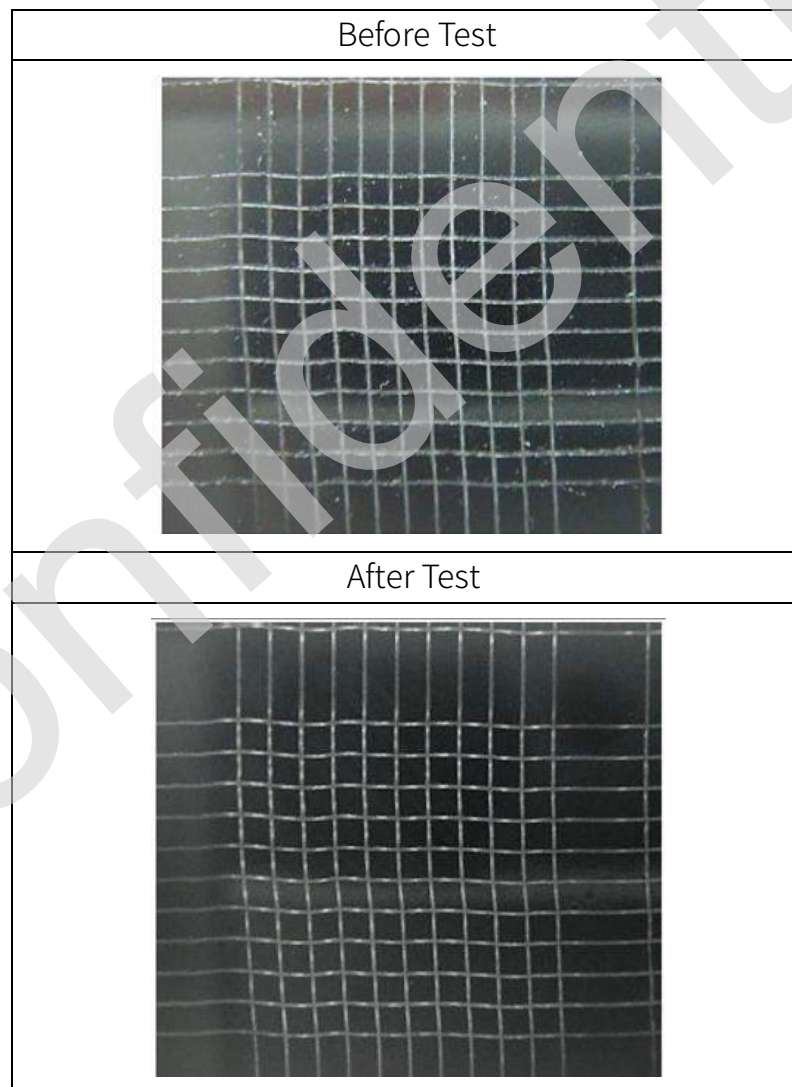



6.3.3 RCA TEST

LABORATORY AMBIENCE CONDITION

Temperature: 25 °C ± 5 °C

Relative humidity: 55 % ± 15 % (RH)

TEST CONDITION

Weight: 175 g

Test cycles : 30 cycles, 50 cycles, 80 cycles, 100 cycles

SUMMARY OF TEST

Visual inspection of sample surfaces showed no abnormality.

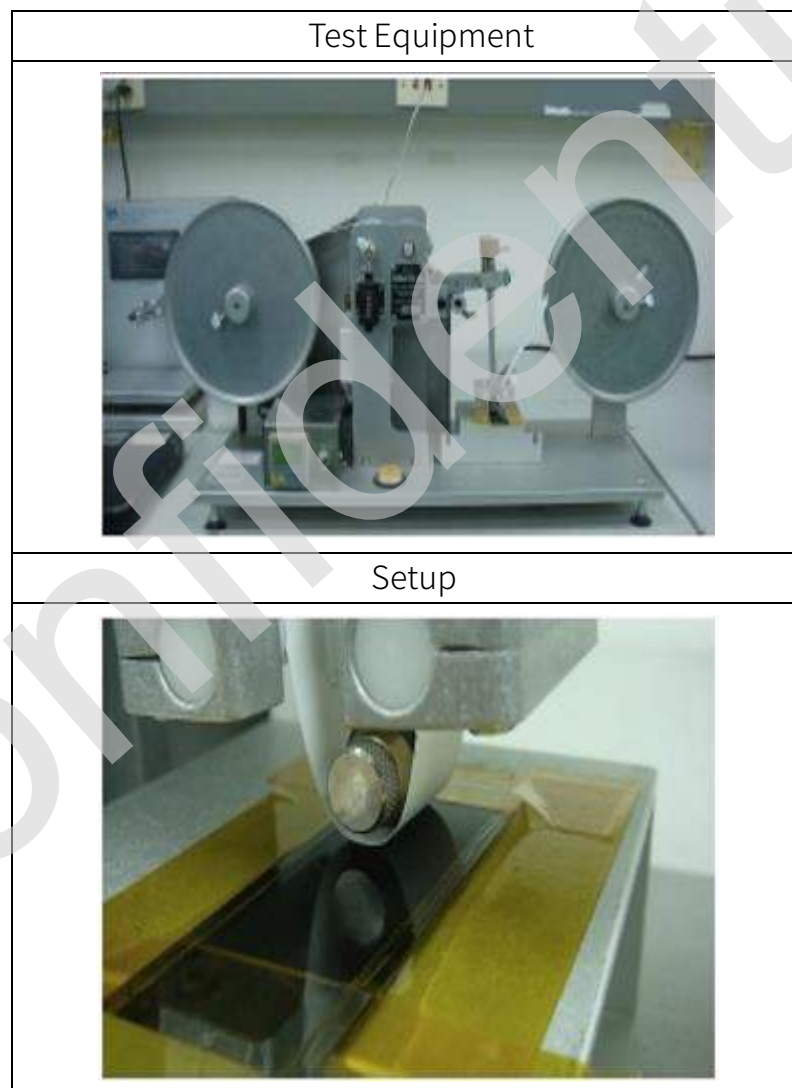



6.3.4 ALCOHOL ABRASION TEST

LABORATORY AMBIENCE CONDITION

Temperature: 25 °C ± 5 °C

Relative humidity: 55 % ± 15 % (RH)

TEST CONDITION

Load: 75 gf

Speed: 30 cycles / minute

Test cycle: 10000 cycles

SUMMARY OF TEST

After testing, visual inspection of sample surfaces showed no abnormality.

Test Equipment



Setup

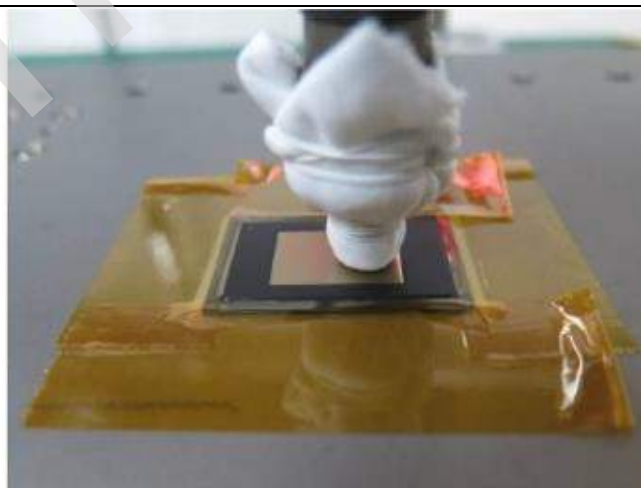



7 Revisionhistory

Version	Date	Changes	Approved	Checked	Author
V0.1	2018/04/12	Initial draft	Colman	PC Yu	Apple Wang