

# MS233-10\*

## DRAWN-SEAMLESS EMI/RFI SHIELD

### \*OPTIONAL SHIELD CONFIGURATIONS

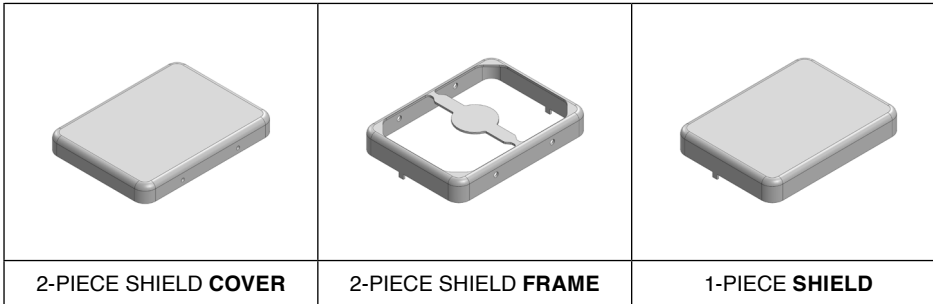

ITEM P/N	ITEM DESCRIPTION	MATERIAL
<a href="#">MS233-10C</a>	2-PIECE EMI/RFI SHIELD <b>COVER</b>	TIN-PLATED STEEL
<a href="#">MS233-10F</a>	2-PIECE EMI/RFI SHIELD <b>FRAME</b>	TIN-PLATED STEEL
<a href="#">MS233-10S</a>	1-PIECE EMI/RFI <b>SHIELD</b>	TIN-PLATED STEEL
<a href="#">MS233-10C-NS</a>	2-PIECE EMI/RFI SHIELD <b>COVER</b>	NICKEL-SILVER
<a href="#">MS233-10F-NS</a>	2-PIECE EMI/RFI SHIELD <b>FRAME</b>	NICKEL-SILVER
<a href="#">MS233-10S-NS</a>	1-PIECE EMI/RFI <b>SHIELD</b>	NICKEL-SILVER

**TIN-PLATED STEEL:** CRS ELECTROLYTIC TINPLATE

**NICKEL-SILVER:** UNS C77000 / UNS C73500



SHIELD CONFIGURATION:

MATERIAL:

© MASACH TECH LTD.  
 22 HAGANAN, MODIIN 7169513 ISRAEL  
 T: (+972) 8-9754681 / F: (+972) 8-9754682  
[info@masach.com](mailto:info@masach.com) / [www.masach.com](http://www.masach.com)

SHIELD TYPE:





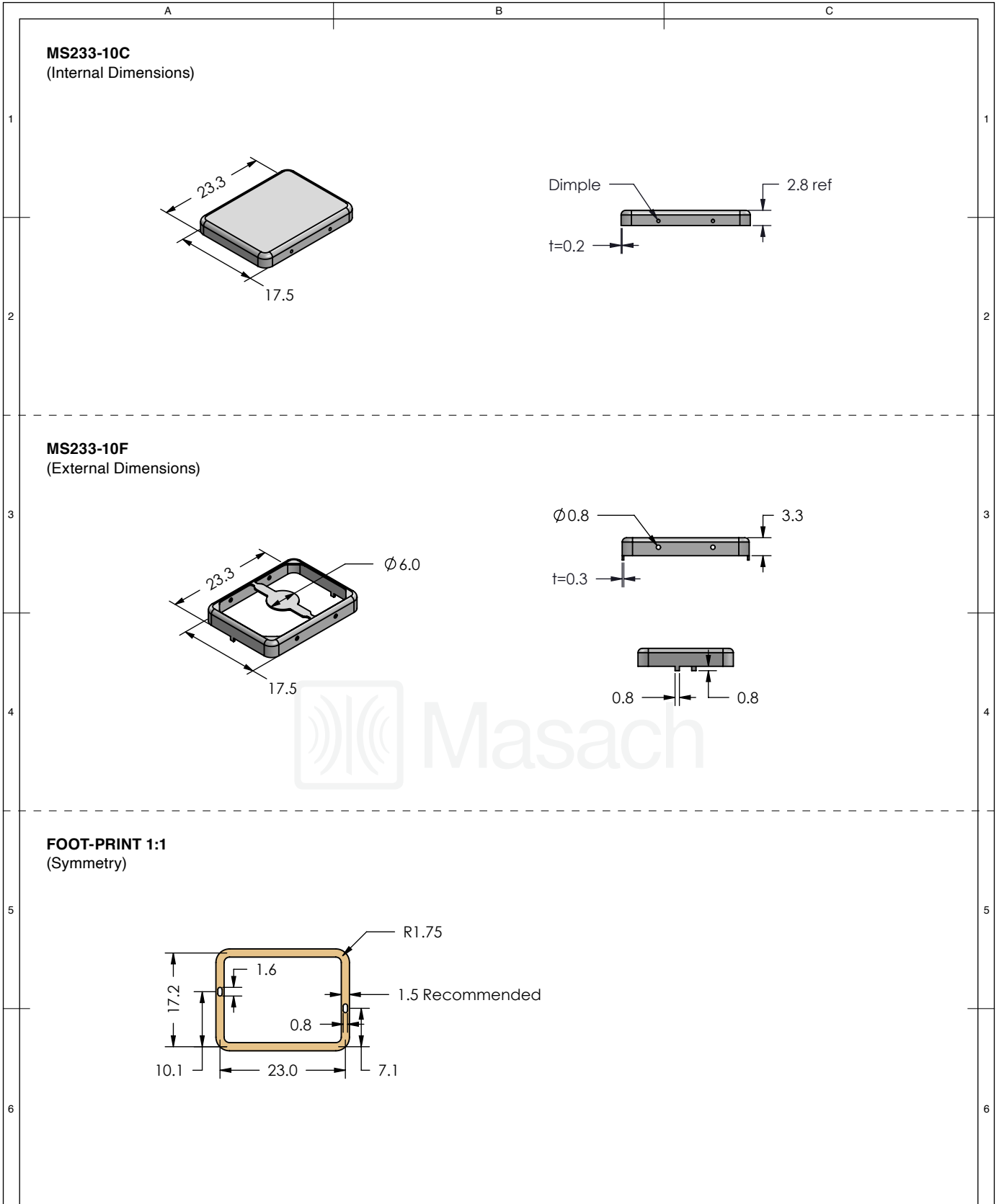

MMGS / PRINT 1:1 / A4

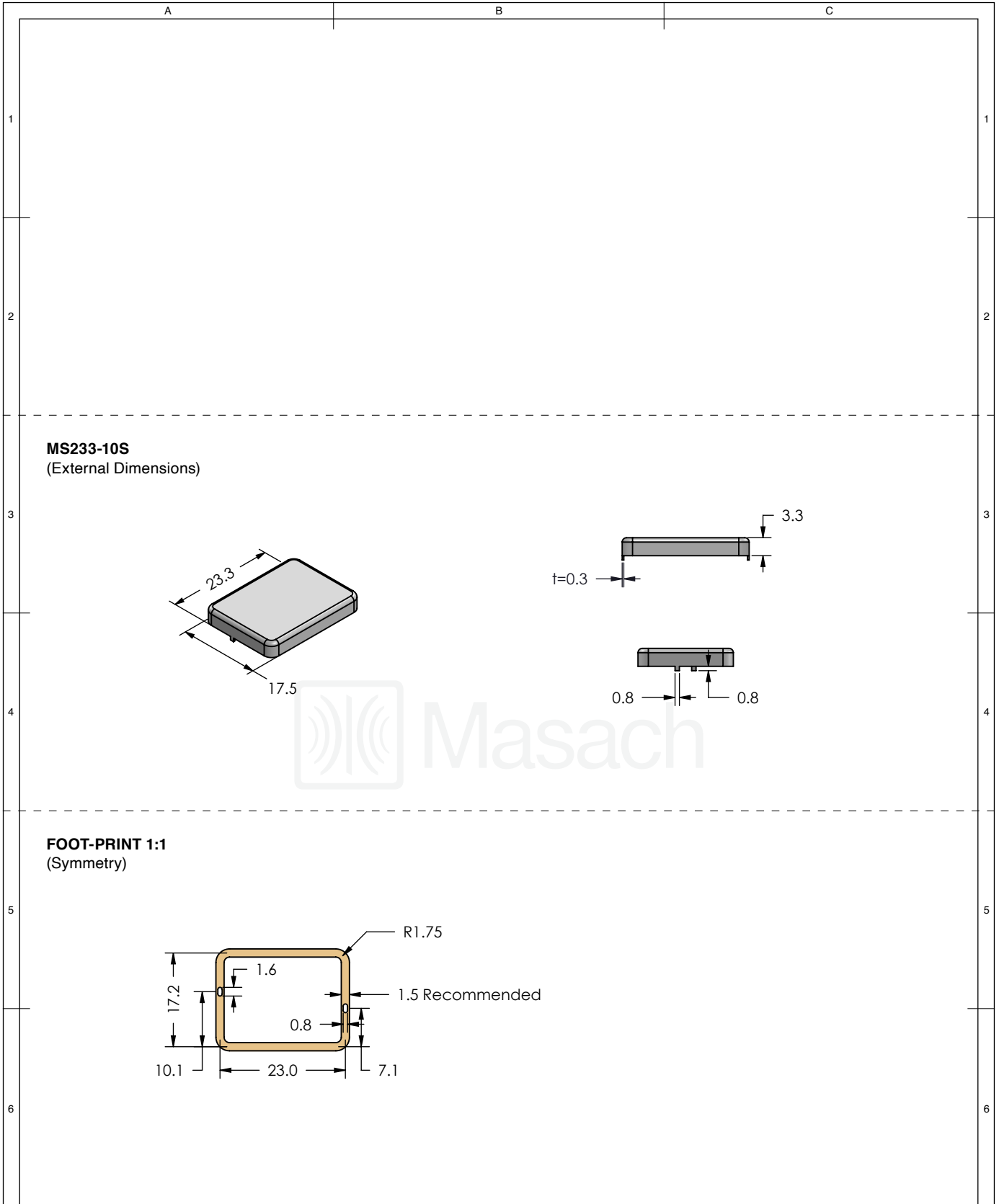

	SHIELD CONFIGURATION:		MATERIAL:	
	<b>2-PIECE EM/RFI SHIELD</b>		<b>TIN-PLATED STEEL <sup>(1)</sup></b>	
	<b>NOTE:</b> (1) CRS ELECTROLYTIC TINPLATE (2) GENERAL TOLERANCE (+/-) 0.2MM			
© MASACH TECH LTD. 22 HAGANAN, MODIIN 7169513 ISRAEL T: (+972) 8-9754681 / F: (+972) 8-9754682 <a href="mailto:info@masach.com">info@masach.com</a> / <a href="http://www.masach.com">www.masach.com</a>	SHIELD TYPE:		 	
	<b>DRAWN-SEAMLESS EM/RFI SHIELD</b>			

This product has been designed and manufactured by © Masach Tech Ltd. The use of this product in any type of electronic device or application is not under Masach Tech Ltd. liability.

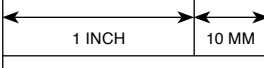

	SHIELD CONFIGURATION:	MATERIAL:
	<b>1-PIECE EM/RFI SHIELD</b>	<b>TIN-PLATED STEEL <sup>(1)</sup></b>
<b>NOTE:</b> (1) CRS ELECTROLYTIC TINPLATE (2) GENERAL TOLERANCE (+/-) 0.2MM		
© MASACH TECH LTD. 22 HAGANAN, MODIIN 7169513 ISRAEL T: (+972) 8-9754681 / F: (+972) 8-9754682 <a href="mailto:info@masach.com">info@masach.com</a> / <a href="http://www.masach.com">www.masach.com</a>	SHIELD TYPE:	 
	<b>DRAWN-SEAMLESS EM/RFI SHIELD</b>	
MMGS / PRINT 1:1 / A4		

This product has been designed and manufactured by © Masach Tech Ltd. The use of this product in any type of electronic device or application is not under Masach Tech Ltd. liability.

**MS233-10C-NS**  
(Internal Dimensions)

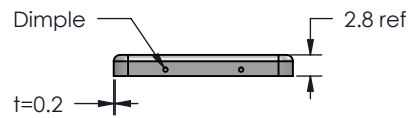
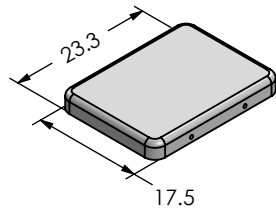

**MS233-10F-NS**  
(External Dimensions)

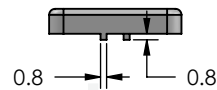
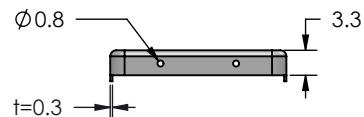
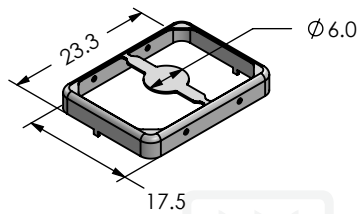

**FOOT-PRINT 1:1**  
(Symmetry)

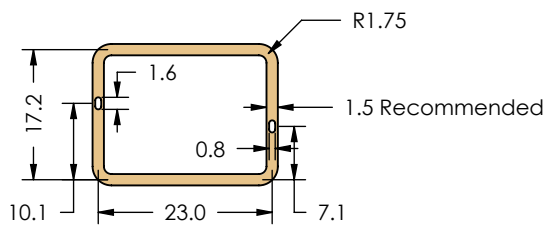

SHIELD CONFIGURATION:

**2-PIECE EM/RFI SHIELD**

MATERIAL:

**NICKEL-SILVER <sup>(1)</sup>**

**NOTE:** (1) UNS C77000 / UNS C73500 (2) GENERAL TOLERANCE (+/-) 0.2MM

© MASACH TECH LTD.  
22 HAGANAN, MODIIN 7169513 ISRAEL  
T: (+972) 8-9754681 / F: (+972) 8-9754682  
info@masach.com / www.masach.com

SHIELD TYPE:

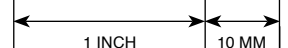

**DRAWN-SEAMLESS EM/RFI SHIELD**

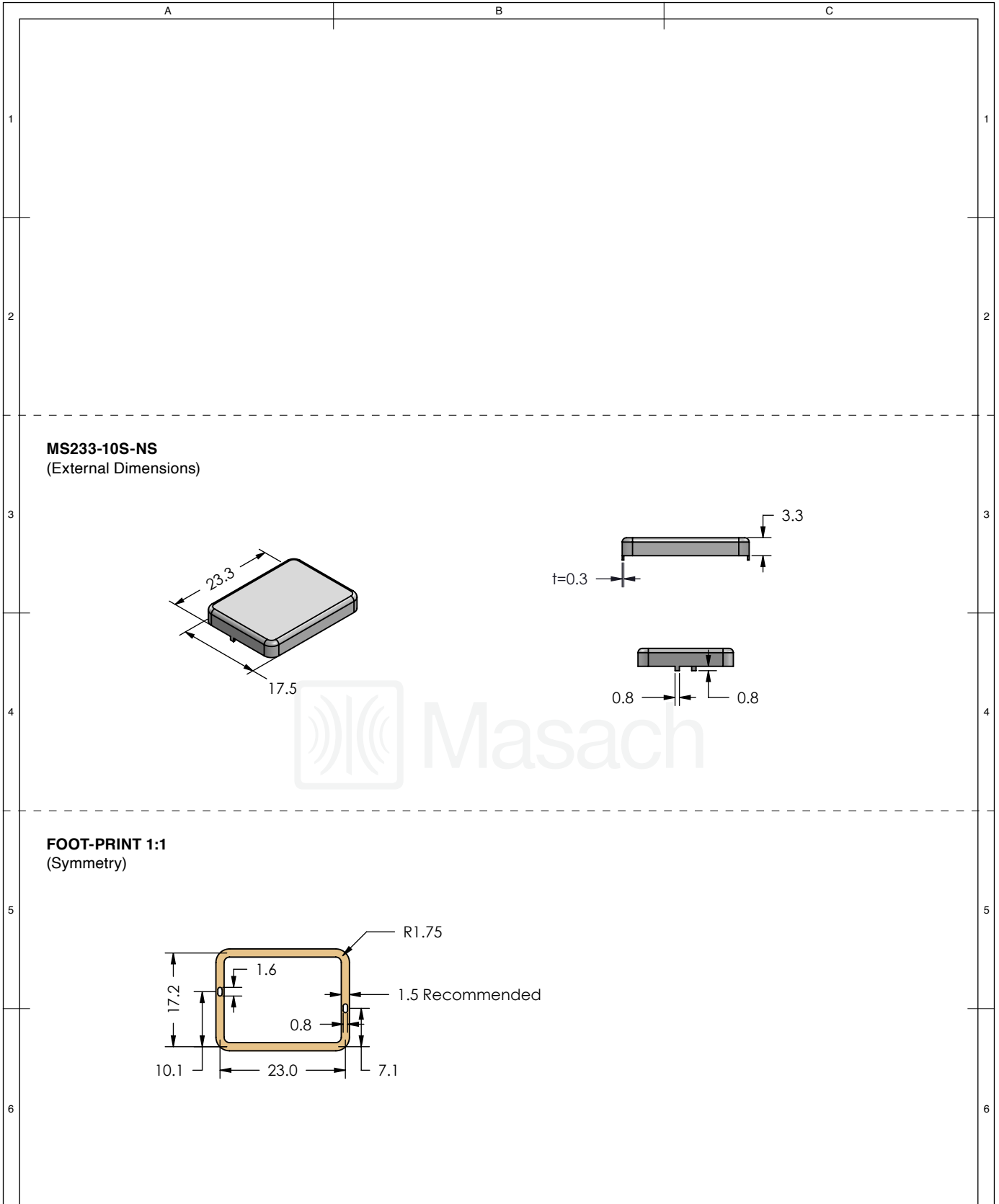

MMGS / PRINT 1:1 / A4

This product has been designed and manufactured by © Masach Tech Ltd. The use of this product in any type of electronic device or application is not under Masach Tech Ltd. liability.

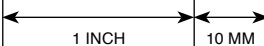

	SHIELD CONFIGURATION:		MATERIAL:	
	<b>1-PIECE EM/RFI SHIELD</b>		<b>NICKEL-SILVER <sup>(1)</sup></b>	
	<b>NOTE:</b> (1) UNS C77000 / UNS C73500 (2) GENERAL TOLERANCE (+/-) 0.2MM			
© MASACH TECH LTD. 22 HAGANAN, MODIIN 7169513 ISRAEL T: (+972) 8-9754681 / F: (+972) 8-9754682 <a href="mailto:info@masach.com">info@masach.com</a> / <a href="http://www.masach.com">www.masach.com</a>	SHIELD TYPE:		 	
	<b>DRAWN-SEAMLESS EM/RFI SHIELD</b>			

This product has been designed and manufactured by © Masach Tech Ltd. The use of this product in any type of electronic device or application is not under Masach Tech Ltd. liability.

A

B

C

# MS233-10\* SMT/SMD PACKING TRAY

\* COMPATIBLE TO ALL SHIELD CONFIGURATIONS

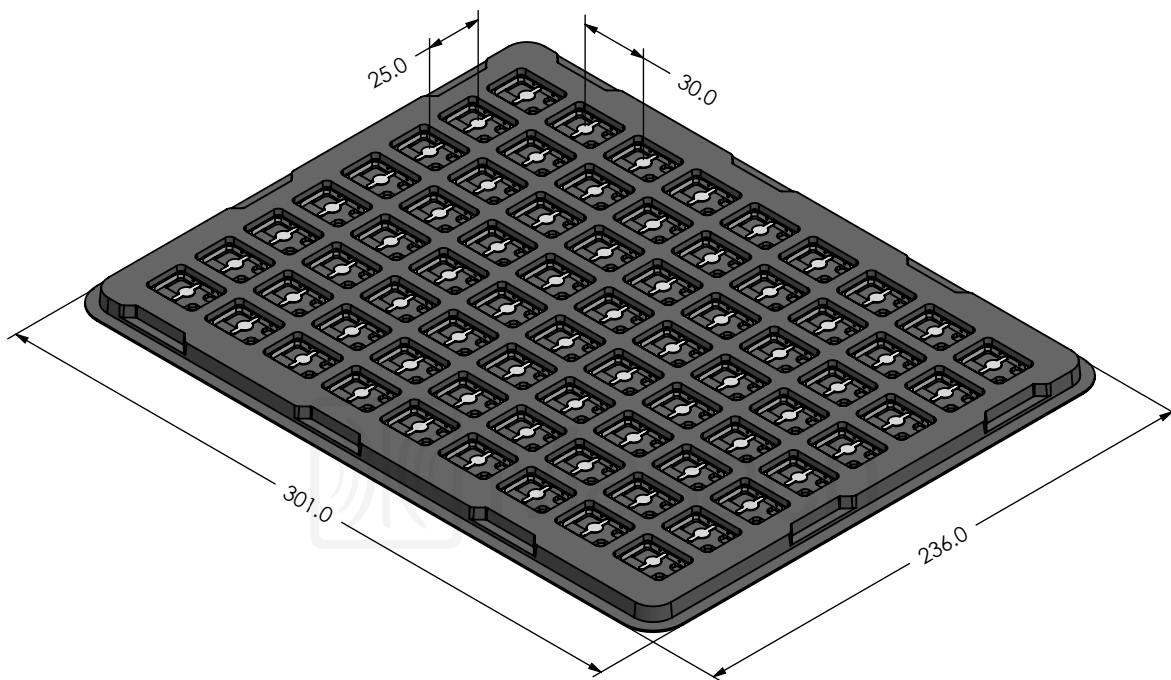

1

1

2

2

3

3

4

4

5

5

6

6



SHIELD CONFIGURATION:

MATERIAL:

© MASACH TECH LTD.  
 22 HAGANAN, MODIIN 7169513 ISRAEL  
 T: (+972) 8-9754681 / F: (+972) 8-9754682  
[info@masach.com](mailto:info@masach.com) / [www.masach.com](http://www.masach.com)

SHIELD TYPE:

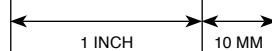

MMGS / PRINT 1:1 / A4

This product has been designed and manufactured by © Masach Tech Ltd. The use of this product in any type of electronic device or application is not under Masach Tech Ltd. liability.

[BACK TO TOP](#)