

0.8 A - 600 V sensitive gate SCR

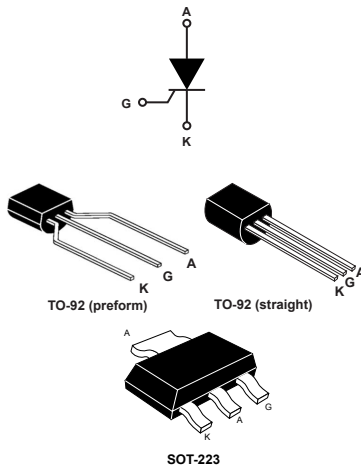

Features

- On-state rms current, $I_{T(RMS)}$ 0.8 A
- Repetitive peak off-state voltage 600 V
- Triggering gate current from 30 to 200 μ A
- ECOPACK2 compliant

Applications

- Limited gate current topologies
- Ground fault circuit interrupters
- Overvoltage crowbar protection in power supplies
- Protection in electronic ballasts
- Capacitive discharge ignitions
- Igniters (lighting, oven...)

Description

The X00619 SCR can be used as on/off function in applications where topology does not offer high current for gate triggering.

This device is optimized in forward voltage drop and inrush current capabilities for reduced power losses and high reliability in harsh environments.

Product status link	
X00619	TO92 straight leads (bulk packing)
	TO92 leads preform (tape and reel or ammopack packing)
	SOT-223 (tape and reel packing)

Product summary	
$I_{T(RMS)}$	up to 0.8 A
V_{DRM}/V_{RRM}	600 V
I_{GT}	From 30 to 200 μ A
$T_{jmax.}$	125 °C

1 Characteristics

Table 1. Absolute maximum ratings (limiting values, $T_j = 25\text{ °C}$ unless otherwise specified)

Symbol	Parameters			Value	Unit
$I_{T(RMS)}$	On-state RMS current (180° conduction angle)	TO-92	$T_L = 83\text{ °C}$	0.8	A
		SOT-223	$T_{amb} = 107\text{ °C}$		
$I_{T(AV)}$	Average on-state current (180° conduction angle)	TO-92	$T_L = 83\text{ °C}$	0.5	A
		SOT-223	$T_{amb} = 107\text{ °C}$		
I_{TSM}	Non repetitive surge peak on-state current, T_j initial = 25 °C	$t_p = 8.3\text{ ms}$	$T_j = 25\text{ °C}$	10	A
		$t_p = 10\text{ ms}$		9	
I^2t	I^2t value for fusing	$t_p = 10\text{ ms}$	$T_j = 25\text{ °C}$	0.4	A^2s
di/dt	Critical rate of rise of on-state current $I_G = 2 \times I_{GT}$, $t_r \leq 100\text{ ns}$	$F = 60\text{ Hz}$	$T_j = 125\text{ °C}$	50	$A/\mu s$
I_{GM}	Peak gate current	$t_p = 20\text{ }\mu s$	$T_j = 125\text{ °C}$	1	A
$P_{G(AV)}$	Average gate power dissipation		$T_j = 125\text{ °C}$	0.1	W
T_{stg}	Storage junction temperature range			-40 to +150	°C
T_j	Operating junction temperature range			-40 to +125	°C

Table 2. Electrical characteristics ($T_j = 25\text{ °C}$, unless otherwise specified)

Symbol	Parameters		Value	Unit
I_{GT}	$V_D = 12\text{ V}$, $R_L = 140\text{ }\Omega$	Min.	30	μA
		Max.	200	
V_{GT}		Max.	0.8	V
V_{GD}	$V_D = V_{DRM}$, $R_L = 3.3\text{ k}\Omega$, $R_{GK} = 1\text{ k}\Omega$, $T_j = 125\text{ °C}$	Min.	0.2	V
V_{RG}	$I_{RG} = 10\text{ }\mu A$	Min.	5	
I_H	$I_T = 50\text{ mA}$, $R_{GK} = 1\text{ k}\Omega$	Max.	5	mA
I_L	$I_G = 1\text{ mA}$, $R_{GK} = 1\text{ k}\Omega$	Max.	6	mA
dV/dt	$V_D = 67\% V_{DRM}$, $R_{GK} = 1\text{ k}\Omega$, $T_j = 125\text{ °C}$	Min.	40	$V/\mu s$

Table 3. Static electrical characteristics

Symbol	Test conditions			Value	Unit
V_{TM}	$I_{TM} = 1\text{ A}$, $t_p = 380\text{ }\mu s$	25 °C	Max.	1.35	V
V_{TO}	Threshold on-state voltage	125 °C	Max.	0.85	V
R_d	Dynamic resistance	125 °C	Max.	245	m Ω
I_{DRM}	$V_{DRM} = V_{RRM}$, $R_{GK} = 1\text{ k}\Omega$	25 °C	Max.	1	μA
I_{RRM}	$V_{DRM} = V_{RRM}$, $R_{GK} = 1\text{ k}\Omega$	125 °C		100	

Table 4. Thermal resistance

Symbol	Parameters		Max. value	Unit
$R_{th(j-l)}$	Junction to leads (DC)		70	°C/W
$R_{th(j-c)}$	Junction to case (DC)		30	
$R_{th(j-a)}$	Junction to ambient (DC)		150	
	Junction to ambient (DC)	$S^{(1)} = 5 \text{ cm}^2$	60	

1. S = Copper surface under tab.

1.1 Characteristics (curves)

Figure 1. Maximum average power dissipation versus average on-state current

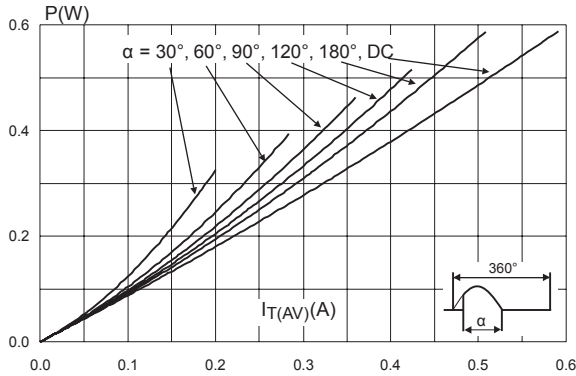

Figure 2. Average and DC on-state current versus case temperature (SOT-223)

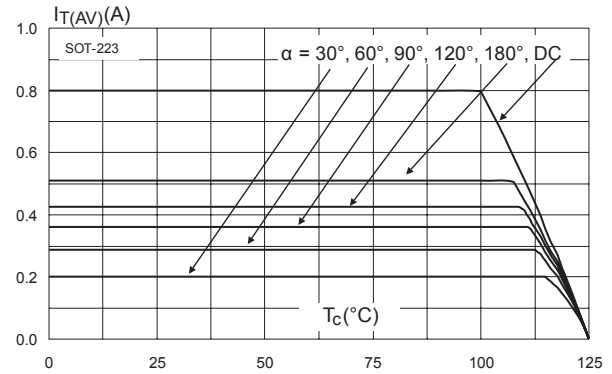

Figure 3. Average and DC on-state current versus lead temperature (TO-92)

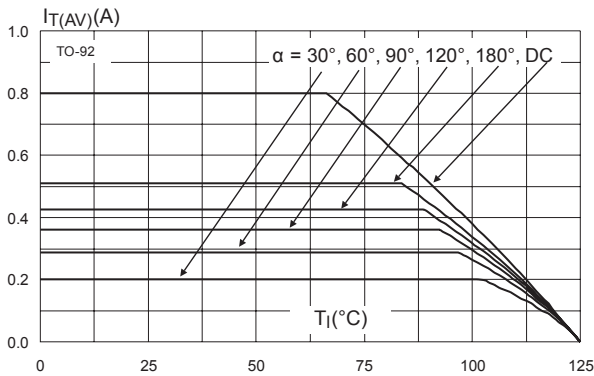

Figure 4. Average and DC on-state current versus ambient temperature (free air convection)

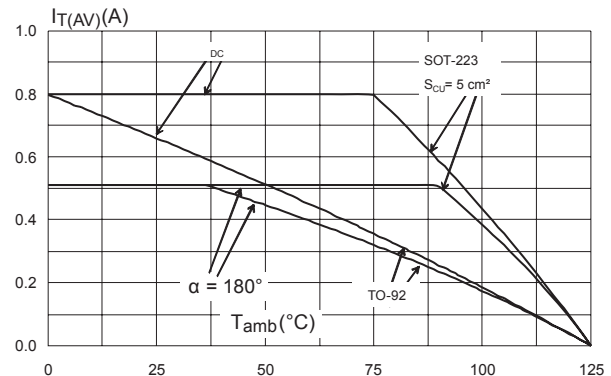

Figure 5. Relative variation of thermal impedance junction to ambient versus pulse duration

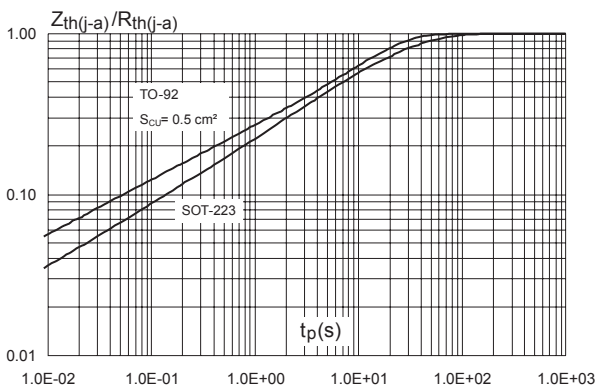

Figure 6. Relative variation of gate trigger, holding and latching current versus junction temperature

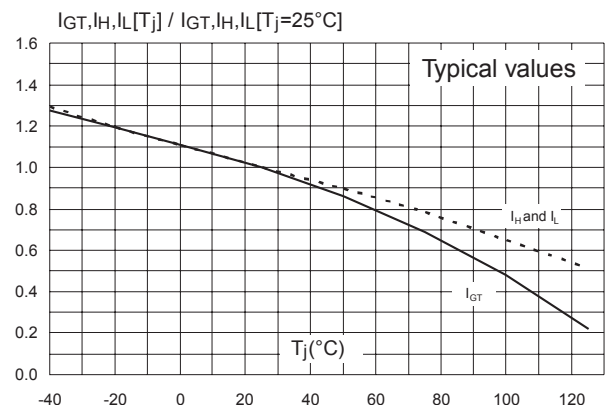

Figure 7. Relative variation of holding current versus gate-cathode resistance (typical values)

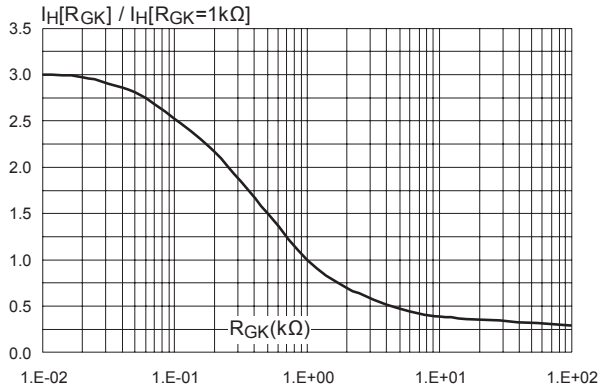

Figure 8. Relative variation of static dV/dt immunity versus gate-cathode resistance (typical values)

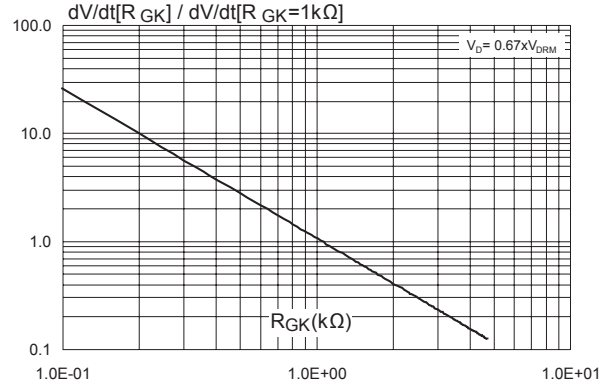

Figure 9. Relative variation of static dV/dt immunity versus gate-cathode capacitance (typical values)

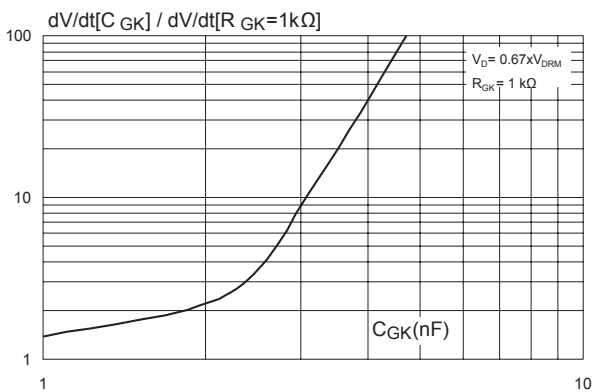

Figure 10. Surge peak on-state current versus number of cycles

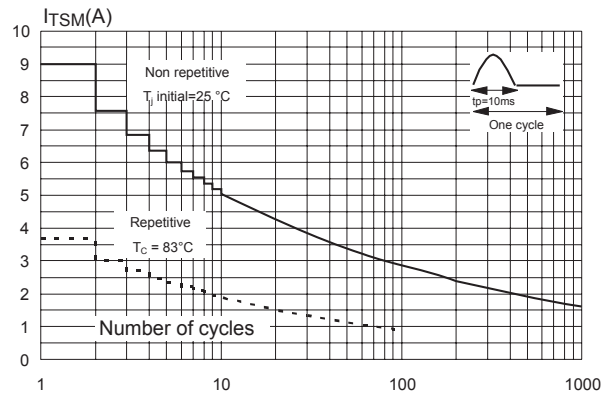

Figure 11. Non-repetitive surge peak on-state current for sinusoidal pulse ($t_p < 10 ms$)

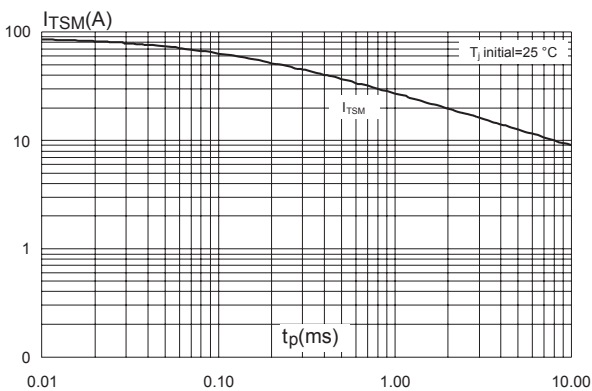

Figure 12. On-state characteristics (maximum values)

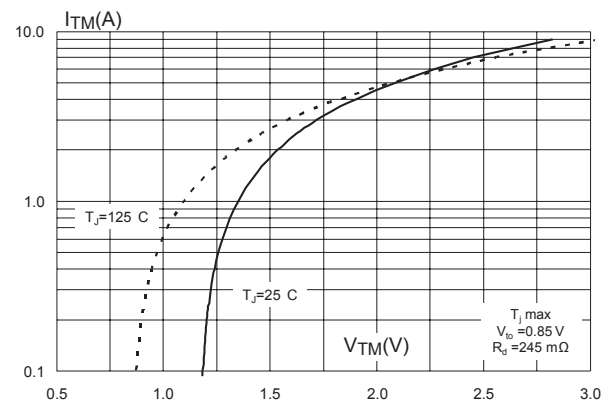
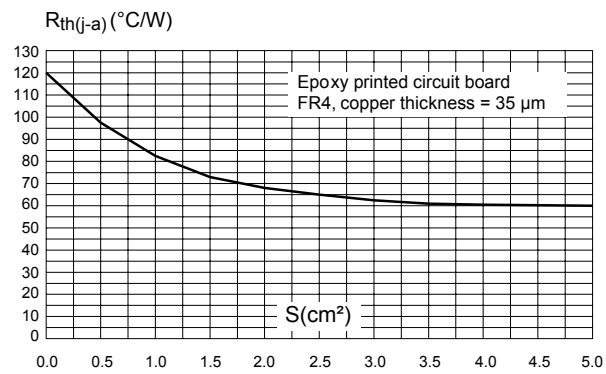

Figure 13. Thermal resistance junction to ambient versus copper surface under tab



2 Package information

In order to meet environmental requirements, ST offers these devices in different grades of **ECOPACK** packages, depending on their level of environmental compliance. ECOPACK specifications, grade definitions and product status are available at: www.st.com. ECOPACK is an ST trademark.

2.1 TO-92 package information

- Lead free plating + halogen-free molding resin
- Epoxy meets UL94, V0

Figure 14. TO-92 with straight leads (plastic) package outline

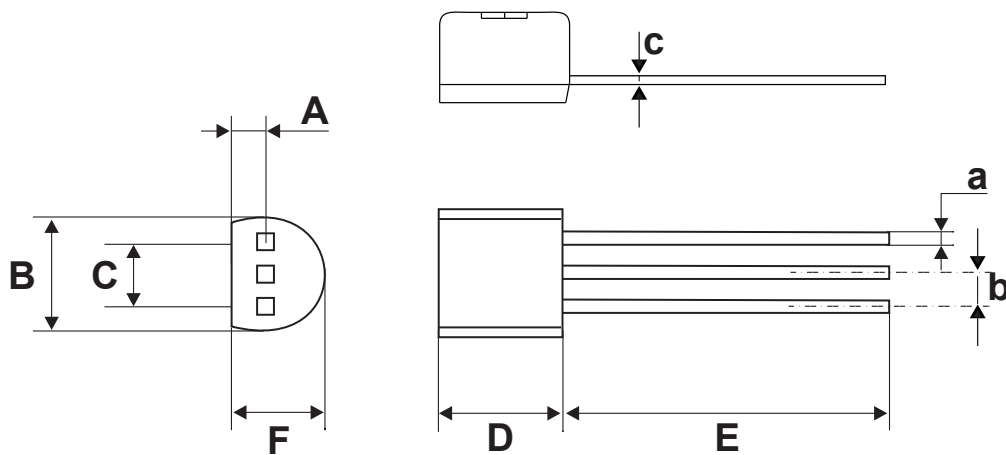

Table 5. TO-92 with straight leads (plastic) package mechanical data

Ref.	Dimensions					
	Millimeters			Inches ⁽¹⁾		
	Min.	Typ.	Max.	Min.	Typ.	Max.
A		1.35			0.048	
B			4.70			0.190
C		2.54			0.100	
D	4.40			0.172		
E	12.70			0.554		
F			3.70			0.152
a			0.50			0.022
b		1.27			0.050	
c			0.48			0.019

1. Inches dimensions given for information

2.2 TO-92 with leads preform (plastic) package information

- Lead free plating + halogen-free molding resin
- Epoxy meets UL94, V0

Figure 15. TO-92 with leads preform (plastic) package outline

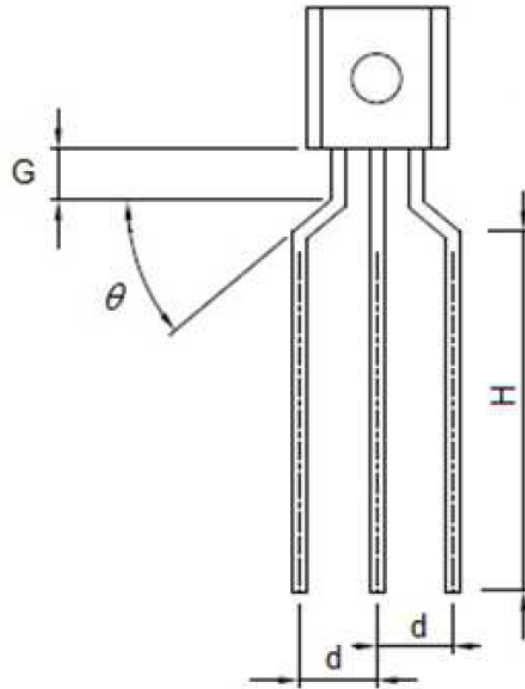

Table 6. TO-92 with leads preform (plastic) package mechanical data

Ref.	Dimensions					
	Millimeters			Inches ⁽¹⁾		
	Min.	Typ.	Max.	Min.	Typ.	Max.
G	1.30	1.70	2.00	0.051	0.067	0.079
H	7.69		9.69	0.303		0.381
d	2.40		2.90	0.094		0.114
θ	30°	40°	50°	30°	40°	50°

1. Inches dimensions given for information

2.3 SOT-223 package information

- Epoxy meets UL94, V0
- Lead free plating + halogen-free molding resin

Figure 16. SOT-223 package outline

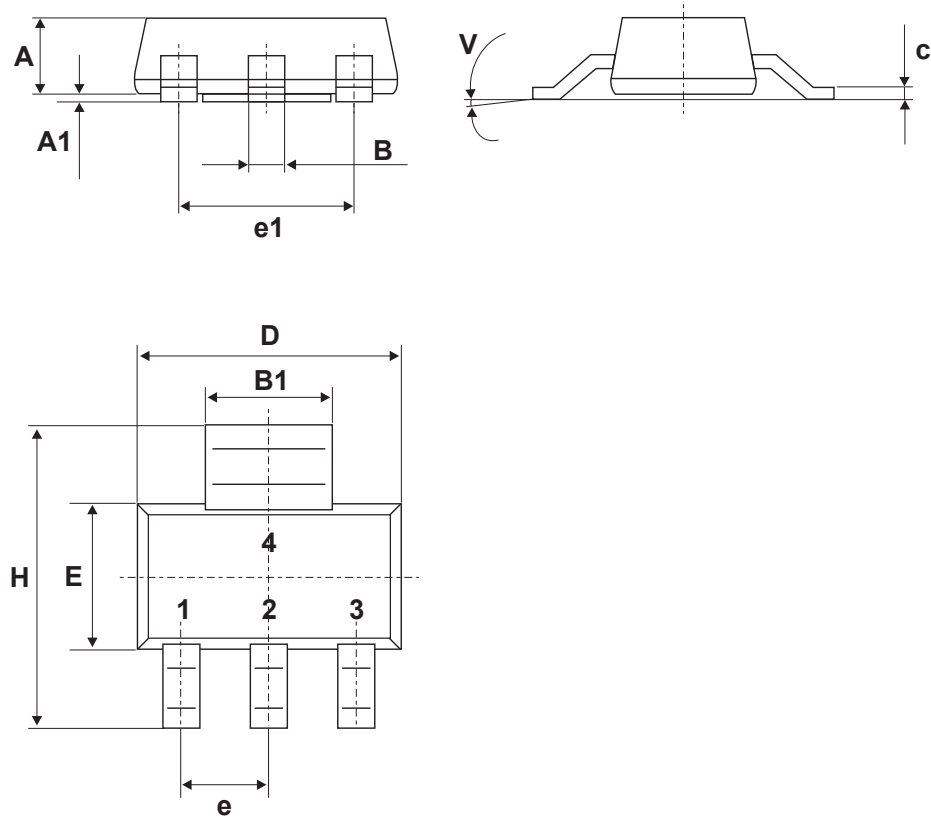
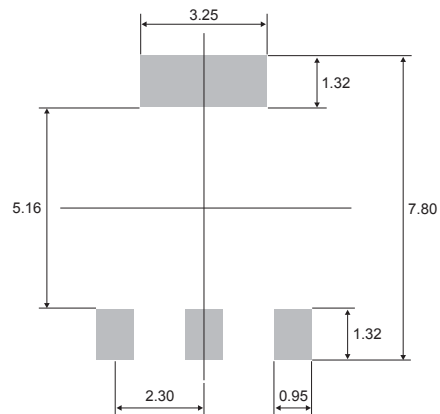

Table 7. SOT-223 package mechanical data

Ref.	Dimensions					
	Millimeters			Inches ⁽¹⁾		
	Min.	Typ.	Max.	Min.	Typ.	Max.
A			1.80			0.0709
A1		0.02	0.10		0.0008	0.0039
B	0.60	0.70	0.85	0.024	0.0276	0.0335
B1	2.90	3.00	3.15	0.114	0.1181	0.1240
c	0.24	0.26	0.35	0.009	0.0102	0.0138
D	6.30	6.50	6.70	0.248	0.2559	0.2638
e		2.3			0.0906	
e1		4.6			0.1811	
E	3.30	3.50	3.70	0.130	0.1378	0.1457
H	6.70	7.00	7.30	0.264	0.2756	0.2874
V	10° max.					

1. Inches only for reference

Figure 17. SOT-223 footprint (dimensions in mm)



3 Ordering information

Figure 18. Ordering information scheme

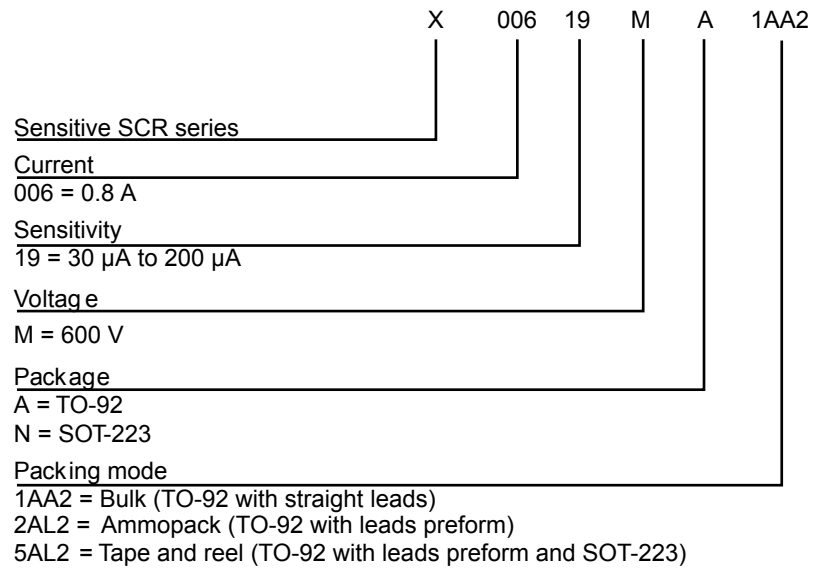

Table 8. Ordering information

Order code	Marking	Package	Weight	Base qty.	Delivery mode
X00619MA1AA2	X0619 MA	TO-92 straight leads	0.2 g	2500	Bulk
X00619MA2AL2		TO-92 leads preform	0.2 g	2000	Ammopack
X00619MA5AL2			0.2 g	2000	Tape and reel
X00619MN5AL2	X0 619 MN	SOT-223	0.12 g	1000	

Revision history

Table 9. Document revision history

Date	Revision	Changes
26-May-2009	1	First issue.
03-May-2012	2	Added SOT-223 package.
03-Sep-2021	3	Inserted TO-92 with leads preform package.
20-Dec-2021	4	Updated Figure 10 and Figure 11 .

IMPORTANT NOTICE – PLEASE READ CAREFULLY

STMicroelectronics NV and its subsidiaries (“ST”) reserve the right to make changes, corrections, enhancements, modifications, and improvements to ST products and/or to this document at any time without notice. Purchasers should obtain the latest relevant information on ST products before placing orders. ST products are sold pursuant to ST’s terms and conditions of sale in place at the time of order acknowledgement.

Purchasers are solely responsible for the choice, selection, and use of ST products and ST assumes no liability for application assistance or the design of Purchasers’ products.

No license, express or implied, to any intellectual property right is granted by ST herein.

Resale of ST products with provisions different from the information set forth herein shall void any warranty granted by ST for such product.

ST and the ST logo are trademarks of ST. For additional information about ST trademarks, please refer to www.st.com/trademarks. All other product or service names are the property of their respective owners.

Information in this document supersedes and replaces information previously supplied in any prior versions of this document.

© 2021 STMicroelectronics – All rights reserved