

MAXIM

Single/Dual/Triple/Quad Operational Amplifiers

ICL761X/2X/3X/4X

General Description

The ICL761X/762X/763X/764X family of monolithic CMOS op amps combine ultra low input current with low power operation over a wide supply voltage range. With pin selectable quiescent currents of 10, 100, or 1000 μA per amplifier, these op amps will operate from $\pm 1\text{V}$ to $\pm 8\text{V}$ power supplies, or from single supplies from 2V to 16V. The CMOS outputs swing to within millivolts of the supply voltages.

The ultra low bias current of 1 pA makes this family of op amps ideal for long time constant integrators, picoameters, low droop rate sample/hold amplifiers and other applications where input bias and offset currents are critical. A low noise current of 0.01 pA/ $\sqrt{\text{Hz}}$ and an input impedance of 10^{12} ohms ensure optimum performance with very high source impedances in such applications as pH meters and photodiode amplifiers.

Applications

- Battery Powered Instruments
- Low Leakage Amplifiers
- Long Time Constant Integrators
- Low Frequency Active Filters
- Hearing Aids and Microphone Amplifiers
- Low Droop Rate Sample/Hold Amplifiers
- Picoameters

Pin Configuration

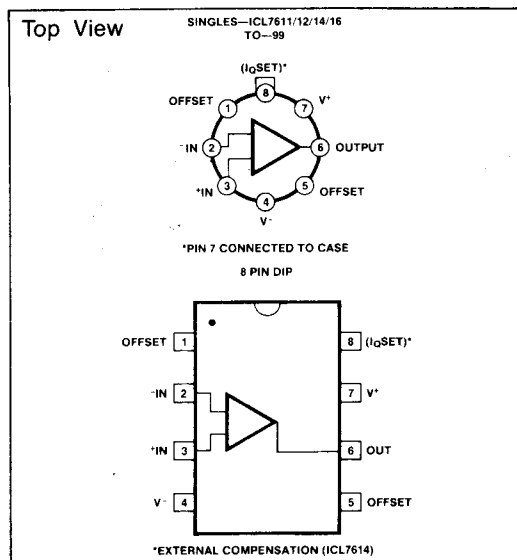

Features

- ◆ Pin-for Pin 2nd Source!
- ◆ 1 pA Typical Bias Current—4 nA Maximum @ 125°C
- ◆ Wide Supply Voltage Range $\pm 1\text{V}$ to $\pm 8\text{V}$
- ◆ Industry Standard Pinouts
- ◆ Programmable Quiescent Currents of 10, 100 and 1000 μA
- ◆ Monolithic, Low Power CMOS Design

Ordering Information

ICL76XX	M	N	OP
V_{OS} SELECTION	TEMP. RANGE		PACKAGE CODE
A=2mV	C=0°C to 70°C		TV - 8 PIN TO-99
B=5mV	M=-55°C to +125°C		PA - 8 PIN PLASTIC DIP
C=10mV			SA - 8 PIN SMALL S.O.
D=15mV			JD - 14 PIN CERDIP
E=20mV			PD - 14 PIN PLASTIC DIP
			SD - 14 PIN SMALL S.O.
			JE - 16 PIN CERDIP
			PE - 16 PIN PLASTIC DIP
			SE - 16 PIN SMALL S.O.
			WE - 16 PIN WIDE S.O.

	Singles		Duals		Triples		Quads	
	ICL7611	ICL7612	ICL7614	ICL7616	ICL7621	ICL7622	ICL7631	ICL7632
Compensated	X	X		X	X	X	X	X
Externally Compensated			X					
Extended CMVR		X		X				
Offset null capability	X	X	X	X		X		
Programmable I _Q	X	X		X			X	X
Fixed I _Q	10 μA							X
	100 μA			X	X	X		
	1 mA							X

5

Typical Operating Circuit

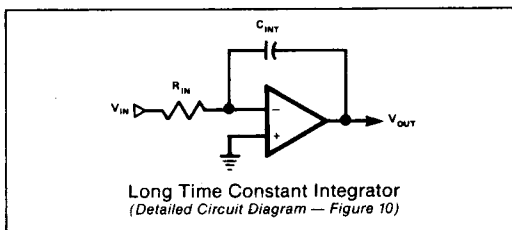

Single/Dual/Triple/Quad Operational Amplifiers

Ordering Information

Single & Dual

PART	TEMP. RANGE	PACKAGE
ICL761XACPA	0°C to +70°C	8 Lead Plastic DIP
ICL761XACSA	0°C to +70°C	8 Lead Slim S.O.
ICL761XACTV	0°C to +70°C	TO-99 Metal Can
ICL761XAMTV	-55°C to +125°C	TO-99 Metal Can
ICL761XBCPA	0°C to +70°C	8 Lead Plastic DIP
ICL761XBCSA	0°C to +70°C	8 Lead Slim S.O.
ICL761XBCTV	0°C to +70°C	TO-99 Metal Can
ICL761XBMTV	-55°C to +125°C	TO-99 Metal Can
ICL761XDCPA	0°C to +70°C	8 Lead Plastic DIP
ICL761XDCSA	0°C to +70°C	8 Lead Slim S.O.
ICL761XDCTV	0°C to +70°C	TO-99 Metal Can
ICL761XDC/D	0°C to +70°C	Dice
ICL7621ACPA	0°C to +70°C	8 Lead Plastic DIP
ICL7621ACSA	0°C to +70°C	8 Lead Slim S.O.
ICL7621ACTV	0°C to +70°C	TO-99 Metal Can
ICL7621AMTV	-55°C to +125°C	TO-99 Metal Can
ICL7621BCPA	0°C to +70°C	8 Lead Plastic DIP
ICL7621BCSA	0°C to +70°C	8 Lead Slim S.O.

PART	TEMP. RANGE	PACKAGE
ICL7621BCTV	0°C to +70°C	TO-99 Metal Can
ICL7621BMTV	-55°C to +125°C	TO-99 Metal Can
ICL7621DCPA	0°C to +70°C	8 Lead Plastic DIP
ICL7621DCSA	0°C to +70°C	8 Lead Slim S.O.
ICL7621DCTV	0°C to +70°C	TO-99 Metal Can
ICL7621DC/D	0°C to +70°C	Dice
ICL7622ACPD	0°C to +70°C	14 Lead Plastic DIP
ICL7622ACSD	0°C to +70°C	14 Lead Slim S.O.
ICL7622ACJD	0°C to +70°C	14 Lead CERDIP
ICL7622AMJD	-55°C to +125°C	14 Lead CERDIP
ICL7622BCPD	0°C to +70°C	14 Lead Plastic DIP
ICL7622BCSA	0°C to +70°C	14 Lead Slim S.O.
ICL7622BCJD	0°C to +70°C	14 Lead CERDIP
ICL7622BMJD	-55°C to +125°C	14 Lead CERDIP
ICL7622DCPD	0°C to +70°C	14 Lead Plastic DIP
ICL7622DCSD	0°C to +70°C	14 Lead Slim S.O.
ICL7622DCJD	0°C to +70°C	14 Lead CERDIP
ICL7622DC/D	0°C to +70°C	Dice

(X above is replaced by: 1, 2, 4, 6)

Pin Configuration

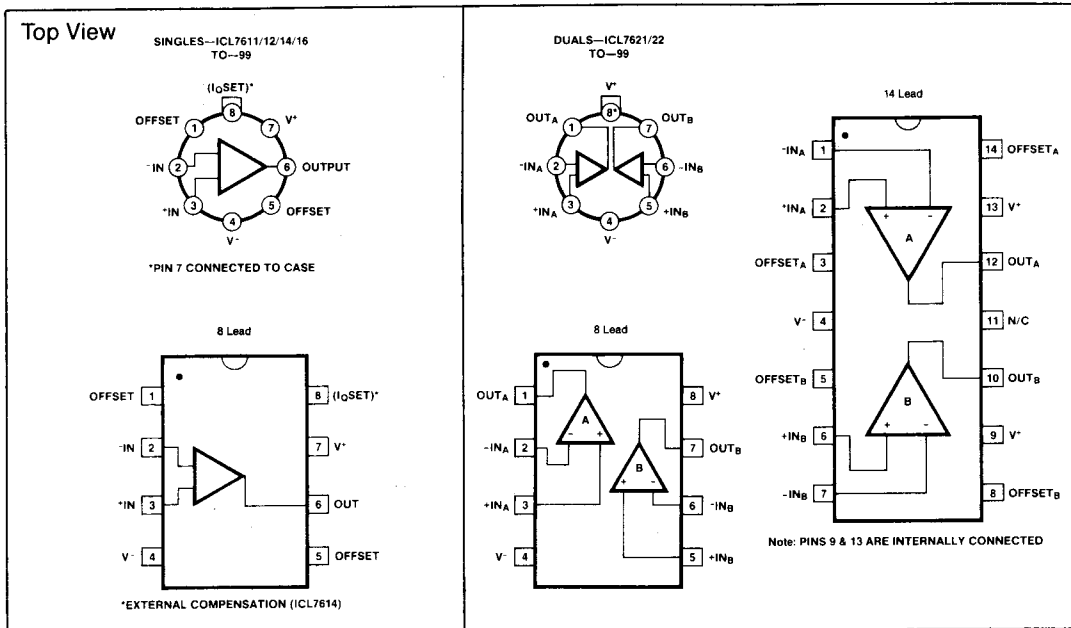

Single/Dual/Triple/Quad Operational Amplifiers

ICL761X/2X/3X/4X

ABSOLUTE MAXIMUM RATINGS¹ – Single & Dual

Total Supply Voltage V^+ to V^-	18V
Input Voltage	$V^+ + 0.3$ to $V^- - 0.3$ V
Differential Input Voltage ²	$\pm[(V^+ + 0.3) - (V^- - 0.3)]$ V
Duration of Output Short Circuit ³	Unlimited
Continuous Power Dissipation @ 25°C	Above 25°C

derate as follows:

TO-99 Metal Can	250mW	2mW/°C
8 Lead Minidip	250mW	2mW/°C
14 Lead Plastic	375mW	3mW/°C
14 Lead CERDIP	500mW	4mW/°C
16 Lead Plastic	375mW	3mW/°C
16 Lead CERDIP	500mW	4mW/°C

Storage Temperature Range

-55°C to +150°C

Operating Temperature Range

M Series	-55°C to +125°C
C Series	0°C to +70°C

Lead Temperature Soldering, 10 sec

300°C

Notes:

- Stresses above those listed under Absolute Maximum Ratings may cause permanent damage to the device. These are stress ratings only, and functional operation of the device at these or any other conditions above those indicated in the operational sections of the specifications is not implied. Exposure to absolute maximum rating conditions for extended periods may affect device reliability.
- Long term offset voltage stability will be degraded if large input differential voltages are applied for long periods of time.
- The outputs may be shorted to ground or to either supply for $V_{SUPP} \leq 10$ V. Care must be taken to insure that the dissipation rating is not exceeded.

ELECTRICAL CHARACTERISTICS – Single & Dual

($V_{SUPP} = \pm 1.0$ V, $I_Q = 10\mu$ A, $T_A = 25^\circ$ C, unless noted)

PARAMETER	SYMBOL	CONDITIONS	76XXA			76XXB			UNITS
			MIN.	TYP.	MAX.	MIN.	TYP.	MAX.	
Input Offset Voltage	V_{OS}	$R_S \leq 100k\Omega$, $T_A = 25^\circ$ C $T_{MIN} \leq T_A \leq T_{MAX}$		2 3			5 7		mV
Temperature Coefficient of V_{OS}	$\Delta V_{OS}/\Delta T$	$R_S \leq 100k\Omega$		10			15		μ V/°C
Input Offset Current	I_{OS}	$T_A = 25^\circ$ C 0° C $\leq T_A \leq +70^\circ$ C		0.5 30 300			0.5 30 300		pA
Input Bias Current	I_{BIAS}	$T_A = 25^\circ$ C 0° C $\leq T_A \leq +70^\circ$ C		1.0 50 500			1.0 50 500		pA
Common Mode Voltage Range (Except ICL7612, ICL7616)	V_{CMR}		-0.4		+0.6	-0.4		+0.6	V
Extended Common Mode Voltage Range (ICL7612 Only)	V_{CMR}		-1.1		+0.6	-1.1		+0.6	V
Extended Common Mode Voltage Range (ICL7616 Only)	V_{CMR}	$I_Q = 10\mu$ A	-1.3		-0.3	-1.3		-0.3	V
Output Voltage Swing	V_{OUT}	$R_L = 1M\Omega$, $T_A = 25^\circ$ C 0° C $\leq T_A \leq +70^\circ$ C		± 0.98 ± 0.96			± 0.98 ± 0.96		V
Large Signal Voltage Gain	A_{VOL}	$V_O = \pm 0.1$ V, $R_L = 1M\Omega$ $T_A = 25^\circ$ C 0° C $\leq T_A \leq +70^\circ$ C		90 80			90 80		dB
Unity Gain Bandwidth	G_{BW}			0.044			0.044		MHz
Input Resistance	R_{IN}			10^{12}			10^{12}		Ω
Common Mode Rejection Ratio	CMRR	$R_S \leq 100k\Omega$		80			80		dB
Power Supply Rejection Ratio	PSRR	$R_S \leq 100k\Omega$		80			80		dB
Input Referred Noise Voltage	e_n	$R_S = 100\Omega$, $f = 1$ kHz		100			100		nV/\sqrt{Hz}
Input Referred Noise Current	i_n	$R_S = 100\Omega$, $f = 1$ kHz		0:01			0:01		pA/\sqrt{Hz}
Supply Current (Per Amplifier)	I_{SUPP}	No Signal, No Load		6	15		6	15	μ A
Slew Rate	SR	$A_{VOL} = 1$, $C_L = 100$ pF, $V_{IN} = 0.2V_{p-p}$ $R_L = 1M\Omega$		0.016			0.016		V/ μ s
Rise Time	t_r	$V_{IN} = 50$ mV, $C_L = 100$ pF $R_L = 1M\Omega$		20			20		μ s
Overshoot Factor		$V_{IN} = 50$ mV, $C_L = 100$ pF $R_L = 1M\Omega$		5			5		%

5

Single/Dual/Triple/Quad Operational Amplifiers

ELECTRICAL CHARACTERISTICS – Single & Dual
($V_{SUPP} = \pm 5.0V$, $T_A = 25^\circ C$, unless noted)

PARAMETER	SYMBOL	CONDITIONS	76XXA			76XXB			76XXD			UNITS
			MIN.	TYP.	MAX.	MIN.	TYP.	MAX.	MIN.	TYP.	MAX.	
Input Offset Voltage	V_{OS}	$R_S \leq 100k\Omega$, $T_A = 25^\circ C$ $T_{MIN} \leq T_A \leq T_{MAX}$		2			5			15		mV
				3			7			20		mV
Temperature Coefficient of V_{OS}	$\Delta V_{OS}/\Delta T$	$R_S \leq 100k\Omega$		10			15			25		$\mu V/^\circ C$
Input Offset Current	I_{OS}	$T_A = 25^\circ C$ $0^\circ C \leq T_A \leq +70^\circ C$ $-55^\circ C \leq T_A \leq +125^\circ C$		0.5	30		0.5	30		0.5	30	pA
					300			300			300	
					800			800			800	
Input Bias Current	I_{BIAS}	$T_A = 25^\circ C$ $0^\circ C \leq T_A \leq +70^\circ C$ $-55^\circ C \leq T_A \leq +125^\circ C$		1.0	50		1.0	50		1.0	50	pA
					400			400			400	
					4000			4000			4000	
Common Mode Voltage Range (Except ICL7612, ICL7616)	V_{CMR}	$I_Q = 10\mu A^1$	+4.4		-4.0	+4.4		-4.0	+4.4		-4.0	V
		$I_Q = 100\mu A^1$	+4.2		-4.0	+4.2		-4.0	+4.2		-4.0	
		$I_Q = 1mA^1$	+3.7		-3.7	+3.7		-3.7	+3.7		-3.7	
Extended Common Mode Voltage Range (ICL7612 Only)	V_{CMR}	$I_Q = 10\mu A$	± 5.3			± 5.3			± 5.3			V
		$I_Q = 100\mu A$	+5.3		-5.1	+5.3		-5.1	+5.3		-5.1	
		$I_Q = 1mA$	+5.3		-4.5	+5.3		-4.5	+5.3		-4.5	
Extended Common Mode Voltage Range (ICL7616 Only)	V_{CMR}	$I_Q = 10\mu A$	-5.3		+3.7	-5.3		+3.7	-5.3		+3.5	V
		$I_Q = 100\mu A$	-5.1		+3.0	-5.1		+3.0	-5.1		+2.7	
		$I_Q = 1mA$	-4.5		+2.0	-4.5		+2.0	-4.5		+1.7	
Output Voltage Swing	V_{OUT}	(1) $I_Q = 10\mu A$, $R_L = 1M\Omega$ $T_A = 25^\circ C$ $0^\circ C \leq T_A \leq +70^\circ C$ $-55^\circ C \leq T_A \leq +125^\circ C$	± 4.9			± 4.9			± 4.9			V
			± 4.8			± 4.8			± 4.8			
			± 4.7			± 4.7			± 4.7			
		$I_Q = 100\mu A$, $R_L = 100k\Omega$ $T_A = 25^\circ C$ $0^\circ C \leq T_A \leq +70^\circ C$ $-55^\circ C \leq T_A \leq +125^\circ C$	± 4.9			± 4.9			± 4.9			
			± 4.8			± 4.8			± 4.8			
			± 4.5			± 4.5			± 4.5			
Large Signal Voltage Gain	A_{VOL}	$V_O = \pm 4.0V$, $R_L = 1M\Omega$ $I_Q = 10\mu A$, $T_A = 25^\circ C$ $0^\circ C \leq T_A \leq +70^\circ C$ $-55^\circ C \leq T_A \leq +125^\circ C$	86	104		80	104		80	104		dB
			80			75			75			
			74			68			68			
		$V_O = \pm 4.0V$, $R_L = 100k\Omega$ $I_Q = 100\mu A$, $T_A = 25^\circ C$ $0^\circ C \leq T_A \leq +70^\circ C$ $-55^\circ C \leq T_A \leq +125^\circ C$	86	102		80	102		80	102		
			80			75			75			
			74			68			68			
	$V_O = \pm 4.0V$, $R_L = 10k\Omega$ $I_Q = 1mA^1$, $T_A = 25^\circ C$ $0^\circ C \leq T_A \leq +70^\circ C$ $-55^\circ C \leq T_A \leq +125^\circ C$	80	83		76	83		76	83			
	76			72			72					
	72			68			68					
Unity Gain Bandwidth	G_{BW}	$I_Q = 10\mu A^1$ $I_Q = 100\mu A$ $I_Q = 1mA^1$		0.044			0.044			0.044		MHz
				0.48			0.48			0.48		
				1.4			1.4			1.4		

Note 1: ICL7611, 7612, 7616 only

Note 2: ICL7614; 39 pF from pin 6 to pin 8.

Single/Dual/Triple/Quad Operational Amplifiers

ICL761X/2X/3X/4X

ELECTRICAL CHARACTERISTICS – Single & Dual (Continued)
($V_{SUPP} = \pm 5.0V$, $T_A = 25^\circ C$, unless noted)

PARAMETER	SYMBOL	CONDITIONS	76XXA			76XXB			76XXD			UNITS
			MIN.	TYP.	MAX.	MIN.	TYP.	MAX.	MIN.	TYP.	MAX.	
Input Resistance	R_{IN}		10^{12}			10^{12}			10^{12}			Ω
Common Mode Rejection Ratio	CMRR	$R_S \leq 100k\Omega$, $I_Q = 10\mu A^1$	76	96		70	96		70	96		dB
		$R_S \leq 100k\Omega$, $I_Q = 100\mu A$	76	91		70	91		70	91		
		$R_S \leq 100k\Omega$, $I_Q = 1mA^1$	66	87		60	87		60	87		
Power Supply Rejection Ratio	PSRR	$R_S \leq 100k\Omega$, $I_Q = 10\mu A^1$	80	94		80	94		80	94		dB
		$R_S \leq 100k\Omega$, $I_Q = 100\mu A$	80	86		80	86		80	86		
		$R_S \leq 100k\Omega$, $I_Q = 1mA^1$	70	77		70	77		70	77		
Input Referred Noise Voltage	e_n	$R_S = 100\Omega$, $f = 1kHz$	100			100			100			nV/\sqrt{Hz}
Input Referred Noise Current	i_n	$R_S = 100\Omega$, $f = 1kHz$	0.01			0.01			0.01			pA/\sqrt{Hz}
Supply Current (Per Amplifier)	I_{SUPP}	No Signal, No Load										mA
		$I_Q = 10\mu A^1$	0.01	0.02		0.01	0.02		0.01	0.02		
		$I_Q = 100\mu A$	0.1	0.25		0.1	0.25		0.1	0.25		
		$I_Q = 1mA^1$	1.0	2.5		1.0	2.5		1.0	2.5		
Channel Separation	V_{O1}/V_{O2}	$A_{VOL} = 100$	120			120			120			dB
Slew Rate ²	SR	$A_{VOL} = 1$, $C_L = 100pF$										$V/\mu s$
		$V_{IN} = 8V_{p-p}$										
		$I_Q = 10\mu A^1$, $R_L = 1M\Omega$	0.016			0.016			0.016			
		$I_Q = 100\mu A$, $R_L = 100k\Omega$	0.16			0.16			0.16			
		$I_Q = 1mA^1$, $R_L = 10k\Omega$	1.6			1.6			1.6			
Rise Time ²	t_r	$V_{IN} = 50mV$, $C_L = 100pF$										μs
		$I_Q = 10\mu A^1$, $R_L = 1M\Omega$	20			20			20			
		$I_Q = 100\mu A$, $R_L = 100k\Omega$	2			2			2			
		$I_Q = 1mA^1$, $R_L = 10k\Omega$	0.9			0.9			0.9			
Overshoot Factor ²		$V_{IN} = 50mV$, $C_L = 100pF$										%
		$I_Q = 10\mu A^1$, $R_L = 1M\Omega$	5			5			5			
		$I_Q = 100\mu A$, $R_L = 100k\Omega$	10			10			10			
		$I_Q = 1mA^1$, $R_L = 10k\Omega$	40			40			40			

Note 1: ICL7611, 7612, 7616 only.
Note 2: ICL7614; 39 pF from pin 6 to pin 8.

Single/Dual/Triple/Quad Operational Amplifiers

Ordering Information

Triple & Quad

PART	TEMP RANGE	PACKAGE
ICL763XBCPE	0°C to +70°C	16 Lead Plastic DIP
ICL763XBCSE	0°C to +70°C	16 Lead Slim S.O.
ICL763XCCPE	0°C to +70°C	16 Lead Plastic DIP
ICL763XCCSE	0°C to +70°C	16 Lead Slim S.O.
ICL763XECPE	0°C to +70°C	16 Lead Plastic DIP
ICL763XECSE	0°C to +70°C	16 Lead Slim S.O.
ICL763XBCJE	0°C to +70°C	16 Lead CERDIP
ICL763XCCJE	0°C to +70°C	16 Lead CERDIP
ICL763XECJE	0°C to +70°C	16 Lead CERDIP
ICL763XBMJE	-55°C to +125°C	16 Lead CERDIP
ICL763XCMJE	-55°C to +125°C	16 Lead CERDIP
ICL763XEC/D	0°C to +70°C	Dice

PART	TEMP RANGE	PACKAGE
ICL764XBCPD	0°C to +70°C	14 Lead Plastic DIP
ICL764XBCWE	0°C to +70°C	16 Lead Wide S.O.
ICL764XCCPD	0°C to +70°C	14 Lead Plastic DIP
ICL764XCCWE	0°C to +70°C	16 Lead Wide S.O.
ICL764XECPD	0°C to +70°C	14 Lead Plastic DIP
ICL764XECWE	0°C to +70°C	16 Lead Wide S.O.
ICL764XBCJD	0°C to +70°C	14 Lead CERDIP
ICL764XCCJD	0°C to +70°C	14 Lead CERDIP
ICL764XECJD	0°C to +70°C	14 Lead CERDIP
ICL764XBMJD	-55°C to +125°C	14 Lead CERDIP
ICL764XCMJD	-55°C to +125°C	14 Lead CERDIP
ICL764XEC/D	0°C to +70°C	Dice

(X above is replaced by: 1, 2)

Pin Configuration

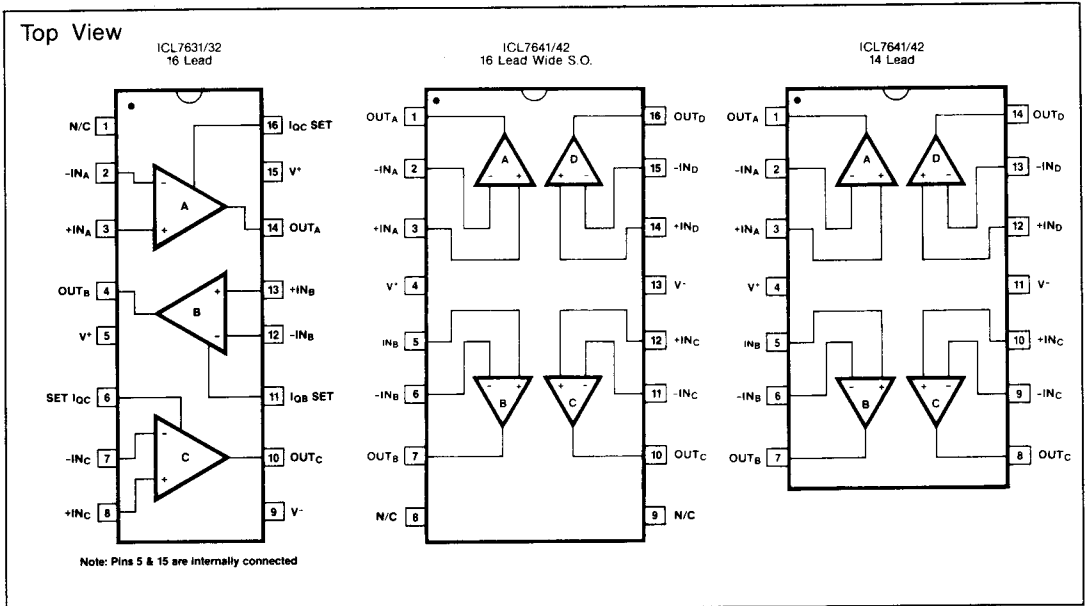

Single/Dual/Triple/Quad Operational Amplifiers

ELECTRICAL CHARACTERISTICS – Triple & Quad
($V_{SUPP} = \pm 5.0V$, $T_A = 25^\circ C$, unless noted)

PARAMETER	SYMBOL	CONDITIONS	76XXB			76XXC			76XXE			UNITS
			MIN.	TYP.	MAX.	MIN.	TYP.	MAX.	MIN.	TYP.	MAX.	
Input Offset Voltage	V_{OS}	$R_S \leq 100k\Omega$, $T_A = 25^\circ C$ $T_{MIN} \leq T_A \leq T_{MAX}$		5			10			20	mV	
				7			15			25	mV	
Temperature Coefficient of V_{OS}	$\Delta V_{OS}/\Delta T$	$R_S \leq 100k\Omega$		15			20			30	$\mu V/^\circ C$	
Input Offset Current	I_{OS}	$T_A = 25^\circ C$ $0^\circ C \leq T_A \leq +70^\circ C$ $-55^\circ C \leq T_A \leq +125^\circ C$	0.5	30		0.5	30		0.5	30	pA	
				300			300			300		
				800			800			800		
Input Bias Current	I_{BIAS}	$T_A = 25^\circ C$ $0^\circ C \leq T_A \leq +70^\circ C$ $-55^\circ C \leq T_A \leq +125^\circ C$	1.0	50		1.0	50		1.0	50	pA	
				500			500			500		
				4000			4000			4000		
Common Mode Voltage Range	V_{CMR}	$I_O = 10\mu A^1$	+4.4			+4.4			+4.4		V	
			-4.0			-4.0			-4.0			
		$I_O = 100\mu A^3$	+4.2			+4.2			+4.2			
											-4.0	
		$I_O = 1mA^2$	+3.7			+3.7			+3.7			
											-3.7	
Output Voltage Swing	V_{OUT}	(1) $I_O = 10\mu A$, $R_L = 1M\Omega$ $T_A = 25^\circ C$ $0^\circ C \leq T_A \leq +70^\circ C$ $-55^\circ C \leq T_A \leq +125^\circ C$	± 4.9			± 4.9			± 4.9		V	
			± 4.8			± 4.8			± 4.8			
			± 4.7			± 4.7			± 4.7			
		(3) $I_O = 100\mu A$, $R_L = 100k\Omega$ $T_A = 25^\circ C$ $0^\circ C \leq T_A \leq +70^\circ C$ $-55^\circ C \leq T_A \leq +125^\circ C$	± 4.9			± 4.9			± 4.9			
			± 4.8			± 4.8			± 4.8			
			± 4.5			± 4.5			± 4.5			
	(2) $I_O = 1mA$, $R_L = 10k\Omega$ $T_A = 25^\circ C$ $0^\circ C \leq T_A \leq +70^\circ C$ $-55^\circ C \leq T_A \leq +125^\circ C$	± 4.5			± 4.5			± 4.5				
			± 4.3			± 4.3			± 4.3			
			± 4.0			± 4.0			± 4.0			
Large Signal Voltage Gain	A_{VOL}	$V_O = \pm 4.0V$, $R_L = 1M\Omega^1$ $I_O = 10\mu A^1$, $T_A = 25^\circ C$ $0^\circ C \leq T_A \leq +70^\circ C$ $-55^\circ C \leq T_A \leq +125^\circ C$	86	104		80	104		80	104	dB	
			80			75			75			
			74			68			68			
		$V_O = \pm 4.0V$, $R_L = 100\mu A$, $T_A = 25^\circ C$ $0^\circ C \leq T_A \leq +70^\circ C$ $-55^\circ C \leq T_A \leq +125^\circ C$	86	102		80	102		80	102		
			80			75			75			
			74			68			68			
		$V_O = \pm 4.0V$, $R_L = 10k\Omega^2$ $I_O = 1mA^1$, $T_A = 25^\circ C$ $0^\circ C \leq T_A \leq +70^\circ C$ $-55^\circ C \leq T_A \leq +125^\circ C$	86	98		80	98		80	98		
			80			75			75			
			74			68			68			
Unity Gain Bandwidth	G_{BW}	$I_O = 10\mu A^1$ $I_O = 100\mu A^3$ $I_O = 1mA^2$	0.044			0.044			0.044			
			0.48			0.48			0.48			
			1.4			1.4			1.4	MHz		
Input Resistance	R_{IN}			10^{12}			10^{12}			10^{12}	Ω	
Common Mode Rejection Ratio	CMRR	$R_S \leq 100k\Omega$, $I_O = 10\mu A^1$	76	96		70	96		70	96	dB	
		$R_S \leq 100k\Omega$, $I_O = 100\mu A$	76	91		70	91		70	91		
		$R_S \leq 100k\Omega$, $I_O = 1mA^2$	66	87		60	87		60	87		
Power Supply Rejection Ratio	PSRR	$R_S \leq 100k\Omega$, $I_O = 10\mu A^1$	80	94		80	94		80	94	dB	
		$R_S \leq 100k\Omega$, $I_O = 100\mu A$	80	86		80	86		80	86		
		$R_S \leq 100k\Omega$, $I_O = 1mA^2$	70	77		70	77		70	77		

Note 1: Does not apply to 7641
Note 2: Does not apply to 7642
Note 3: ICL7631/32 only
Note 4: Does not apply to 7632

Single/Dual/Triple/Quad Operational Amplifiers

ELECTRICAL CHARACTERISTICS – Triple & Quad
($V_{SUPP} = \pm 5.0V$, $T_A = 25^\circ C$, unless noted)

PARAMETER	SYMBOL	CONDITIONS	76XXB			76XXC			76XXE			UNITS
			MIN.	TYP.	MAX.	MIN.	TYP.	MAX.	MIN.	TYP.	MAX.	
Input Offset Voltage	V_{OS}	$R_S \leq 100k\Omega$, $T_A = 25^\circ C$ $T_{MIN} \leq T_A \leq T_{MAX}$		5			10			20	mV	
				7			15			25	mV	
Temperature Coefficient of V_{OS}	$\Delta V_{OS}/\Delta T$	$R_S \leq 100k\Omega$		15			20			30	$\mu V/^\circ C$	
Input Offset Current	I_{OS}	$T_A = 25^\circ C$ $0^\circ C \leq T_A \leq +70^\circ C$ $-55^\circ C \leq T_A \leq +125^\circ C$	0.5	30		0.5	30		0.5	30	pA	
				300			300			300		
				800			800			800		
Input Bias Current	I_{BIAS}	$T_A = 25^\circ C$ $0^\circ C \leq T_A \leq +70^\circ C$ $-55^\circ C \leq T_A \leq +125^\circ C$	1.0	50		1.0	50		1.0	50	pA	
				500			500			500		
				4000			4000			4000		
Common Mode Voltage Range	V_{CMR}	$I_Q = 10\mu A^1$	+4.4			+4.4			+4.4		V	
			-4.0			-4.0			-4.0			
		$I_Q = 100\mu A^3$	+4.2			+4.2			+4.2			
			+4.2			+4.2			+4.2			
			-4.0			-4.0			-4.0			
			+3.7			+3.7			+3.7			
			-3.7			-3.7			-3.7			
Output Voltage Swing	V_{OUT}	(1) $I_Q = 10\mu A$, $R_L = 1M\Omega$ $T_A = 25^\circ C$ $0^\circ C \leq T_A \leq +70^\circ C$ $-55^\circ C \leq T_A \leq +125^\circ C$	± 4.9			± 4.9			± 4.9		V	
			± 4.8			± 4.8			± 4.8			
			± 4.7			± 4.7			± 4.7			
		(3) $I_Q = 100\mu A$, $R_L = 100k\Omega$ $T_A = 25^\circ C$ $0^\circ C \leq T_A \leq +70^\circ C$ $-55^\circ C \leq T_A \leq +125^\circ C$	± 4.9			± 4.9			± 4.9			
			± 4.8			± 4.8			± 4.8			
			± 4.5			± 4.5			± 4.5			
	(2) $I_Q = 1mA$, $R_L = 10k\Omega$ $T_A = 25^\circ C$ $0^\circ C \leq T_A \leq +70^\circ C$ $-55^\circ C \leq T_A \leq +125^\circ C$	± 4.5			± 4.5			± 4.5				
		± 4.3			± 4.3			± 4.3				
		± 4.0			± 4.0			± 4.0				
Large Signal Voltage Gain	A_{VOL}	$V_O = \pm 4.0V$, $R_L = 1M\Omega^1$ $I_Q = 10\mu A^1$, $T_A = 25^\circ C$ $0^\circ C \leq T_A \leq +70^\circ C$ $-55^\circ C \leq T_A \leq +125^\circ C$	86	104		80	104		80	104	dB	
			80			75			75			
			74			68			68			
		$V_O = \pm 4.0V$, $R_L = 100\mu A$, $T_A = 25^\circ C$ $0^\circ C \leq T_A \leq +70^\circ C$ $-55^\circ C \leq T_A \leq +125^\circ C$	86	102		80	102		80	102		
			80			75			75			
			74			68			68			
	$V_O = \pm 4.0V$, $R_L = 10k\Omega^2$ $I_Q = 1mA^1$, $T_A = 25^\circ C$ $0^\circ C \leq T_A \leq +70^\circ C$ $-55^\circ C \leq T_A \leq +125^\circ C$	86	98		80	98		80	98			
		80			75			75				
		74			68			68				
Unity Gain Bandwidth	G_{BW}	$I_Q = 10\mu A^1$ $I_Q = 100\mu A^3$ $I_Q = 1mA^2$		0.044			0.044			0.044	MHz	
				0.48			0.48			0.48		
				1.4			1.4			1.4		
Input Resistance	R_{IN}			10^{12}			10^{12}			10^{12}	Ω	
Common Mode Rejection Ratio	CMRR	$R_S \leq 100k\Omega$, $I_Q = 10\mu A^1$	76	96		70	96		70	96	dB	
		$R_S \leq 100k\Omega$, $I_Q = 100\mu A$	76	91		70	91		70	91		
		$R_S \leq 100k\Omega$, $I_Q = 1mA^2$	66	87		60	87		60	87		
Power Supply Rejection Ratio	PSRR	$R_S \leq 100k\Omega$, $I_Q = 10\mu A^1$	80	94		80	94		80	94	dB	
		$R_S \leq 100k\Omega$, $I_Q = 100\mu A$	80	86		80	86		80	86		
		$R_S \leq 100k\Omega$, $I_Q = 1mA^2$	70	77		70	77		70	77		

Note 1: Does not apply to 7641

Note 2: Does not apply to 7642

Note 3: ICL7631/32 only

Note 4: Does not apply to 7632

Single/Dual/Triple/Quad Operational Amplifiers

ICL761X/2X/3X/4X

ELECTRICAL CHARACTERISTICS — Triple & Quad (Continued)
($V_{SUPP} = \pm 5.0V$, $T_A = 25^\circ C$, unless noted)

PARAMETER	SYMBOL	CONDITIONS	76XXB			76XXC			76XXE			UNITS
			MIN.	TYP.	MAX.	MIN.	TYP.	MAX.	MIN.	TYP.	MAX.	
Input Referred Noise Voltage	e_n	$R_S = 100\Omega$, $f = 1kHz$	100			100			100			nV/\sqrt{Hz}
Input Referred Noise Current	i_n	$R_S = 100\Omega$, $f = 1kHz$	0.01			0.01			0.01			pA/\sqrt{Hz}
Supply Current (Per Amplifier)	I_{SUPP}	No Signal, No Load $I_Q = 10\mu A^1$ $I_Q = 100\mu A$ $I_Q = 1mA^2$	0.01	0.022		0.01	0.022		0.01	0.022		mA
Channel Separation	V_{O1}/V_{O2}	$A_{VOL} = 100$	120			120			120			dB
Slew Rate ⁴	SR	$A_{VOL} = 1$, $C_L = 100pF$ $V_{IN} = 8V_{p-p}$ $I_Q = 10\mu A^1$, $R_L = 1M\Omega$ $I_Q = 100\mu A$, $R_L = 100k\Omega$ $I_Q = 1mA^1$, $R_L = 10k\Omega^2$	0.016			0.016			0.016			$V/\mu s$
Rise Time ⁴	t_r	$V_{IN} = 50mV$, $C_L = 100pF$ $I_Q = 10\mu A^1$, $R_L = 1M\Omega$ $I_Q = 100\mu A$, $R_L = 100k\Omega$ $I_Q = 1mA^2$, $R_L = 10k\Omega$	20			20			20			μs
Overshoot Factor ⁴		$V_{IN} = 50mV$, $C_L = 100pF$ $I_Q = 10\mu A^1$, $R_L = 1M\Omega$ $I_Q = 100\mu A$, $R_L = 100k\Omega$ $I_Q = 1mA^2$, $R_L = 10k\Omega$	5			5			5			%

Note 1: Does not apply to 7641.
Note 2: Does not apply to 7642.
Note 3: ICL7631/32 only.
Note 4: Does not apply to 7632.

Typical Operating Characteristics

5

MAXIMUM PEAK-TO-PEAK
OUTPUT VOLTAGE AS A FUNCTION OF
FREE-AIR TEMPERATURE

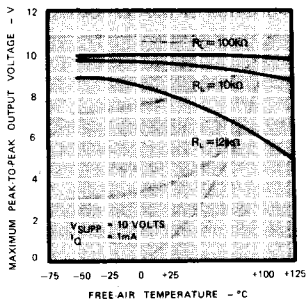

MAXIMUM PEAK-TO-PEAK
OUTPUT VOLTAGE AS A
FUNCTION OF SUPPLY VOLTAGE

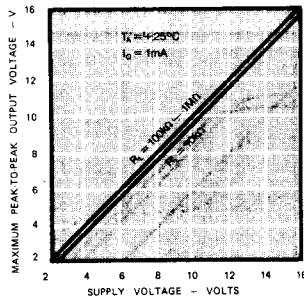

Single/Dual/Triple/Quad Operational Amplifiers

Typical Operating Characteristics

SUPPLY CURRENT PER AMPLIFIER AS A FUNCTION OF SUPPLY VOLTAGE

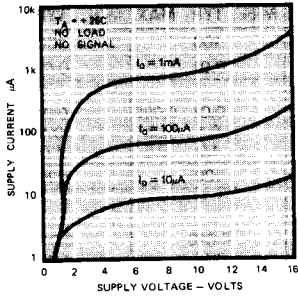

PEAK-TO-PEAK OUTPUT VOLTAGE AS A FUNCTION OF FREQUENCY

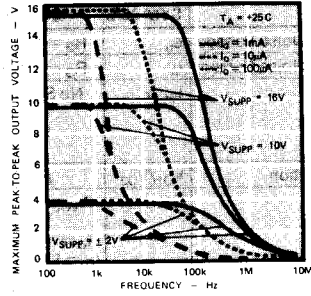

POWER SUPPLY REJECTION RATIO AS A FUNCTION OF FREE-AIR TEMPERATURE

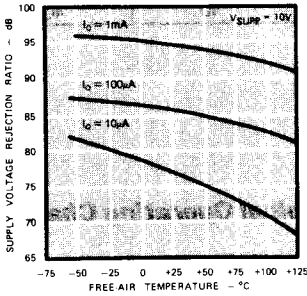

LARGE SIGNAL DIFFERENTIAL VOLTAGE GAIN AS A FUNCTION OF FREE-AIR TEMPERATURE

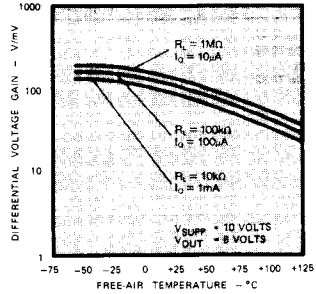

LARGE SIGNAL DIFFERENTIAL VOLTAGE GAIN AND PHASE SHIFT AS A FUNCTION OF FREQUENCY

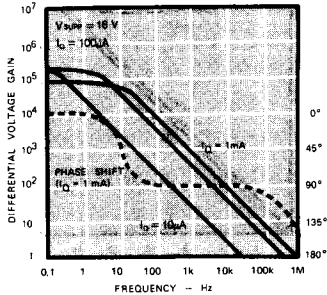

MAXIMUM OUTPUT SINK CURRENT AS A FUNCTION OF SUPPLY VOLTAGE

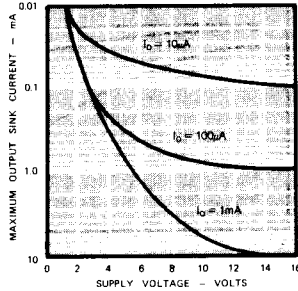

Single/Dual/Triple/Quad Operational Amplifiers

Typical Operating Characteristics

ICL761X/2X/3X/4X

INPUT BIAS CURRENT AS A FUNCTION OF TEMPERATURE

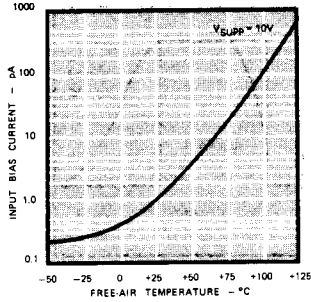

EQUIVALENT INPUT NOISE VOLTAGE AS A FUNCTION OF FREQUENCY

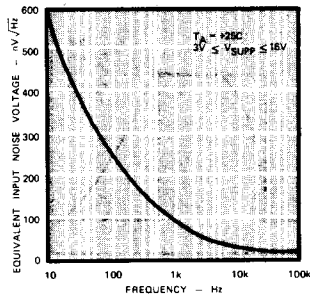

COMMON MODE REJECTION RATIO AS A FUNCTION OF FREE-AIR TEMPERATURE

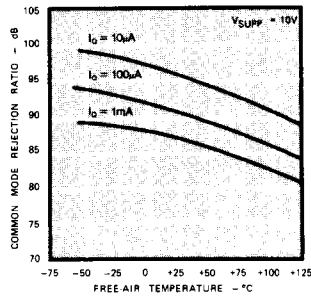

SUPPLY CURRENT PER AMPLIFIER AS A FUNCTION OF FREE-AIR TEMPERATURE

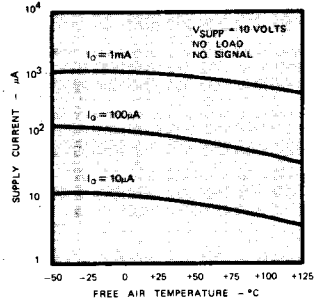

MAXIMUM PEAK-TO-PEAK OUTPUT VOLTAGE AS A FUNCTION OF LOAD RESISTANCE

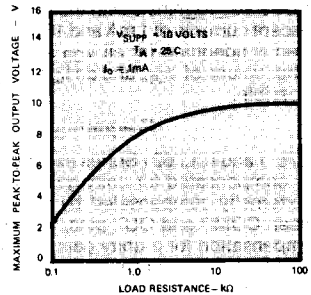

MAXIMUM OUTPUT/SOURCE CURRENT AS A FUNCTION OF SUPPLY VOLTAGE

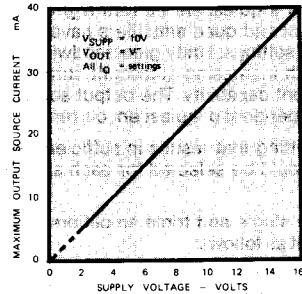

5

Single/Dual/Triple/Quad Operational Amplifiers

Typical Operating Characteristics

VOLTAGE FOLLOWER LARGE SIGNAL PULSE RESPONSE

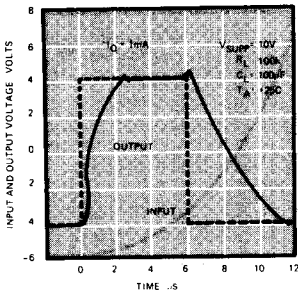

VOLTAGE FOLLOWER LARGE SIGNAL PULSE RESPONSE

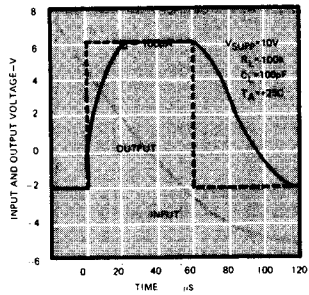

VOLTAGE FOLLOWER LARGE SIGNAL PULSE RESPONSE

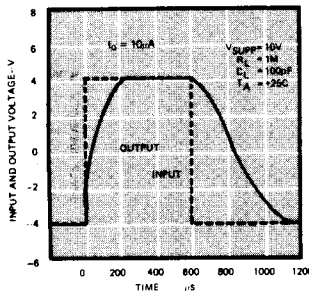

Detailed Description

Quiescent Current Selection

The voltage input to the I_Q pin of the single and triple amplifiers selects a quiescent current (I_Q) of 10, 100 or 1000 μA . The dual and quad amplifiers have fixed quiescent current (I_Q) settings. Unity gain bandwidth and slew rate increase with increasing quiescent current, as does output sink current capability. The output source current capability is independent of quiescent current.

The lowest I_Q setting that results in sufficient bandwidth and slew rate should be selected for each specific application.

The I_Q pin of the single and triple amplifiers controls the quiescent current as follows:

- $I_Q = 10 \mu\text{A}$ I_Q pin to V^+
- $I_Q = 100 \mu\text{A}$ I_Q pin between $V^- + 0.8\text{V}$ and $V^+ - 0.8\text{V}$
- $I_Q = 1 \text{mA}$ I_Q pin to V^-

Input Offset Nulling

The input offset can be nulled by connecting a 25K pot between the OFFSET terminals with the wiper connected to V^+ . At quiescent currents of 1 mA and 100 μA , the nulling range provided is adequate for all V_{OS} selections. However with higher values of V_{OS} , and an I_Q of 10 μA , nulling may not be possible.

Frequency Compensation

All of the ICL7611 and ICL7621 Series except the ICL7614 are internally compensated for unity gain operation. The ICL7614 is externally compensated by a capacitor connected between COMP and OUT pins, with 39 pF being sufficient compensation for a unity gain buffer. For gains greater than unity, the compensation capacitor value may be reduced to increase the bandwidth and slew rate. The ICL7132 is not compensated and does not have frequency compensation pins. Use only at gains ≥ 20 at I_Q of 1mA; at gains ≥ 10 at I_Q of 100 μA ; at gains ≥ 5 at I_Q of 10 μA .

Single/Dual/Triple/Quad Operational Amplifiers

Output Loading Considerations

Approximately 70% of the amplifier's quiescent current flows in the output stage. The output swing can approach the supply rails for output loads of 1M, 100k and 10k, using the output stage in a highly linear class A mode. Crossover distortion is avoided and the voltage gain is maximized in this mode. The output stage, however, can also be operated in Class AB, which supplies higher output currents. (See graphs under Typical Operating Characteristics). The voltage gain decreases and the output transfer characteristic is non-linear during the transition from Class A to Class B operation.

The output stage, with a gain that is directly proportional to load impedance, approximates a transconductance amplifier. Approximately the same open loop gains are obtained at each of the I_Q settings if corresponding loads of 10k, 100k, and 1M are used.

The maximum output source current is higher than the maximum sink current, and is independent of I_Q .

Like most amplifiers, there are output loads for which the amplifier stability is not guaranteed. In particular, avoid capacitive loads greater than 100 pF; and while on the 1mA I_Q setting, avoid loads less than 5 k Ω . Since the output stage is a transconductance output, very large (>10 μ F) capacitive loads will create a dominant pole and the output will be stable, even with loads that are less than 5 k Ω .

Extended Common Mode Voltage Range, ICL7612 and ICL7616

A common mode voltage range that includes both V^+ and V^- is often desirable, especially in single supply operation. The ICL7612 and ICL7616 extended common mode range op amps are designed specifically to meet this need. The ICL7612 input common mode voltage range (CMVR) extends beyond both power supply rails when operated with at least 3V total supply and an I_Q of 10 μ A or 100 μ A. The ICL7616 CMVR includes the negative supply voltage (or ground when operated with a single supply) at an I_Q of 10 μ A or 100 μ A.

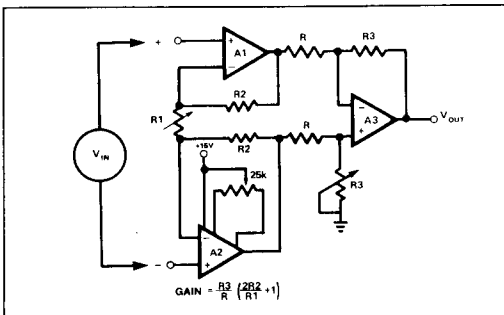

Figure 1. Instrumentation Amplifier—Adjust R3 to improve CMRR. The offset of all three amplifiers is nulled by the offset adjustment of A2.

Printed Circuit Board Layout

Careful PCB layout techniques must be used to take full advantage of the very low bias current of the ICL7611 family. The inputs should be encircled with a low impedance trace, or guard, that is at the same potential as the inputs. In an inverting amplifier this is normally ground; in a unity gain buffer connect the guard to the output. A convenient way of guarding the 8 pin TO-99 version of the ICL7611 is to use a 10 pin circle, with the two extra pads on either side of the input pins to provide space for a guard ring (see Figure 8). Assembled boards should be carefully cleaned, and if a high humidity environment is expected, conformally coated.

Single Supply Operation

The ICL7611 family will operate from a single 2V to 16V power supply. The common mode voltage range of the standard amplifier types when operated from a single supply is 1.0V to ($V^+ - 0.6V$) at 10 μ A I_Q . At 100 μ A I_Q the CMVR is 1.0V to ($V^+ - 0.8V$), and at 1 mA I_Q the CMVR is 1.3V to ($V^+ - 1.3V$). If this CMVR range is insufficient, use the ICL7612, whose CMVR includes both ground and V^+ or the ICL7616, whose CMVR includes ground.

A convenient way to generate a pseudo-ground at $V^+/2$ is to use one op amp of a quad to buffer a $V^+/2$ voltage from a high impedance resistive divider.

Low Voltage Operation

Operation at $V_{SUPP} = \pm 1.0V$ is only guaranteed at $I_Q = 10 \mu A$. Output swings to within a few millivolts of the supply rails are achievable for $R_L (> \text{or} =) 1 M\Omega$. Guaranteed input CMVR is $\pm 0.6V$ minimum and typically $+0.9V$ to $-0.7V$ at $V_{SUPP} = \pm 1.0V$. For applications where greater common mode range is desirable, refer to description of ICL7612 and ICL7616 above.

Applications

5

Note that in no case is I_Q shown. The value of I_Q must be chosen by the designer with regard to frequency response and power dissipation.

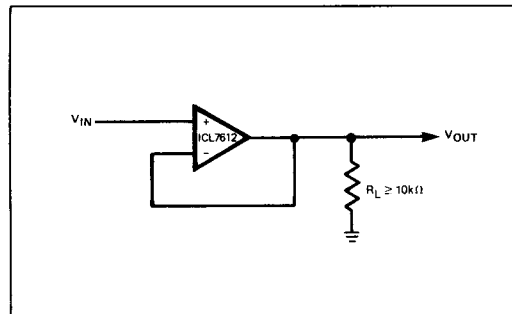

Figure 2. Simple Follower—By using the ICL7612 in these applications, the circuits will follow rail to rail inputs.

Single/Dual/Triple/Quad Operational Amplifiers

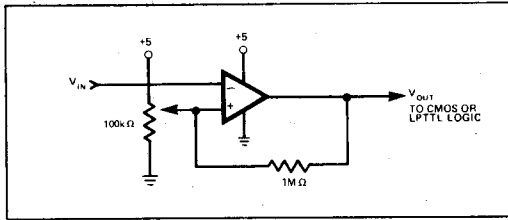

Figure 3. Level Detector — By using the ICL7612 in these applications, the circuits will follow rail to rail inputs.

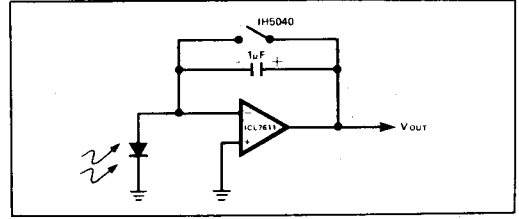

Figure 4. Photocurrent Integrator — Low leakage currents allow integration times up to several hours.

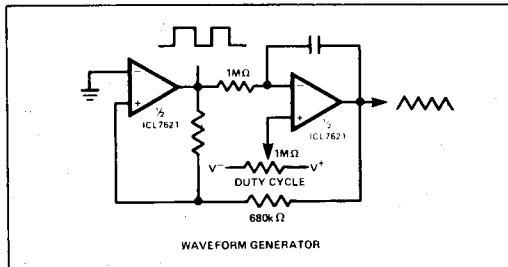

Figure 5. Precise Triangle/Square Wave Generator — The frequency and duty cycle are virtually independent of power supply.

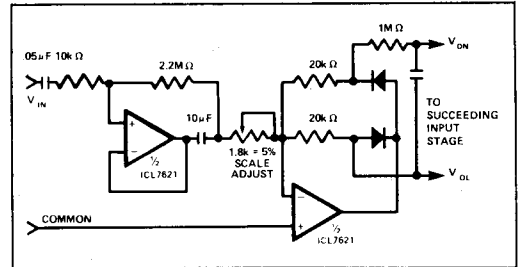

Figure 6. Averaging AC to DC Converter — Recommended for Maxim's ICL7106/07/09 A/D Converters.

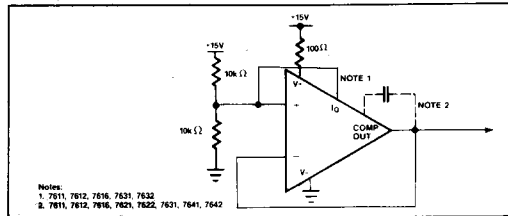

Figure 7. Burn-In and Life Test Circuit

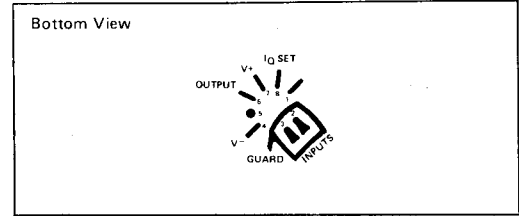

Figure 8. Input Guard for TO-99

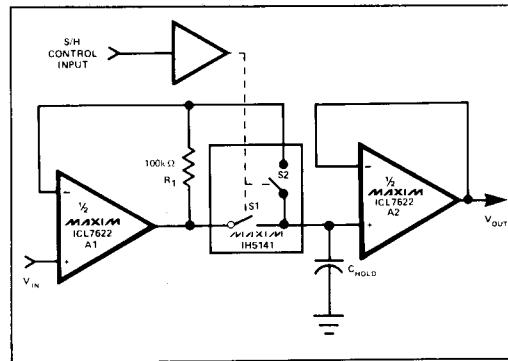

Figure 9. Low Droop Rate Sample & Hold — S2 improves accuracy and acquisition time by including the voltage drop across S1 inside the feedback loop. R1 closes the feedback loop of A1 during the hold phase. The droop rate is $(I_{BIAS(AZ)} + I_{LEAK(S1)} + I_{LEAK(S2)})/C_{HOLD}$.

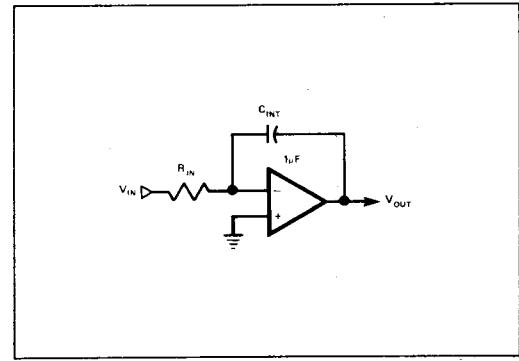

Figure 10. Long Time Constant Integrator — With $R_{IN} = 10^{11}$ ohm, the time constant of this integrator is 100,000 seconds. Since the input voltage is converted to a current by R_{IN} , the input voltage can far exceed the power supply voltage.

Single/Dual/Triple/Quad Operational Amplifiers

ICL761X/2X/3X/4X

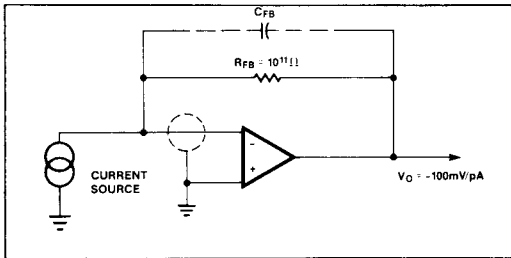

Figure 11. Pico Ammeter — The response time of this circuit is $R_{FB} \times C_{FB}$, where C_{FB} is the stray capacitance between the output and the inverting terminal of the amplifier.

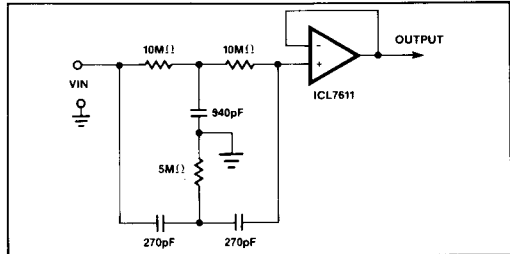
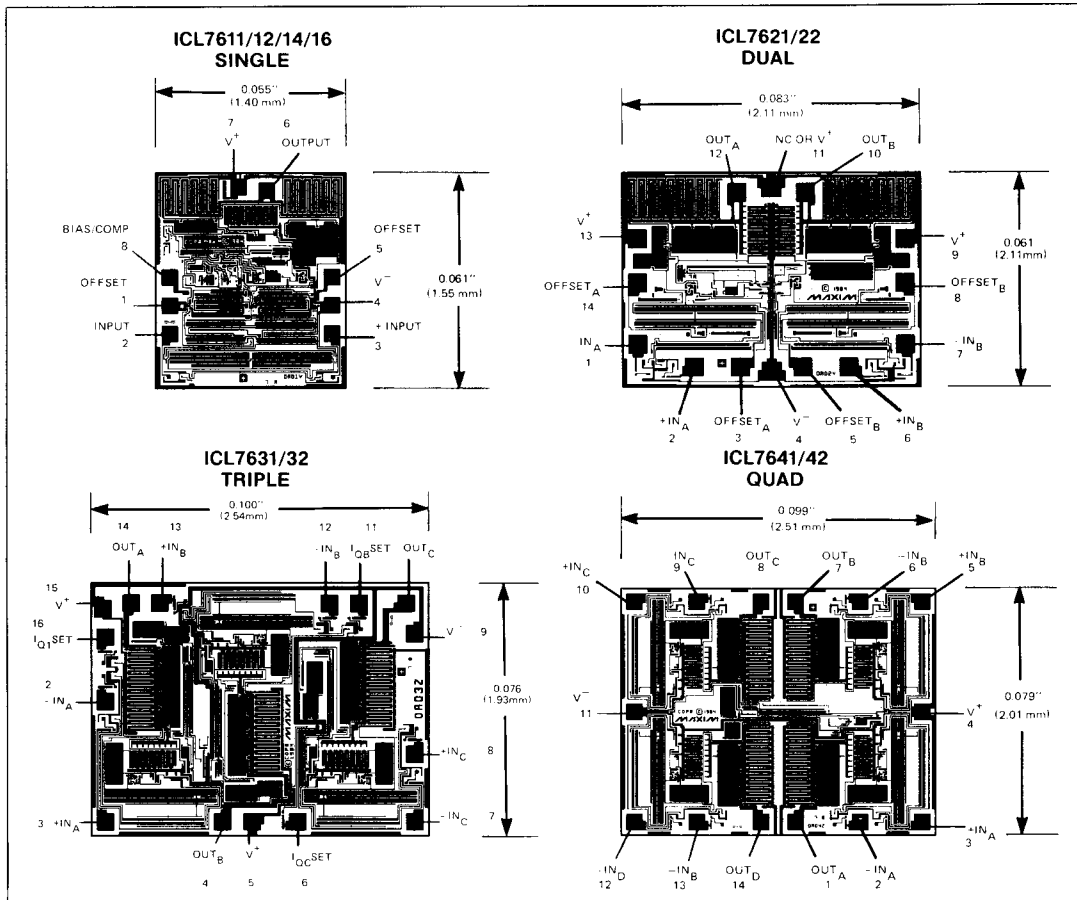

Figure 12. 60 Hz Twin "T" Notch Filter — The low, 1 pA bias current of the ICL7611 allows use of small 540 pF and 270 pF capacitors, even with a notch frequency of 60 Hz. The 60 Hz rejection is approximately 40 dB.

Chip Topographies



5

Maxim cannot assume responsibility for use of any circuitry other than circuitry entirely embodied in a Maxim product. No circuit patent licenses are implied. Maxim reserves the right to change the circuitry and specifications without notice at any time.