

0.7GHz to 1.4GHz High Linearity Upconverting Mixer

FEATURES

- Wide RF Frequency Range: 0.7GHz to 1.4GHz
- 17.1dBm Typical Input IP3 at 1GHz
- On-Chip RF Output Transformer
- On-Chip 50Ω Matched LO and RF Ports
- Single-Ended LO and RF Operation
- Integrated LO Buffer: -5dBm Drive Level
- Low LO to RF Leakage: -44dBm Typical
- Noise Figure: 13.6dB
- Wide IF Frequency Range: 1MHz to 400MHz
- Enable Function with Low Off-State Leakage Current
- Single 5V Supply
- Small 16-Lead QFN Plastic Package

APPLICATIONS

- Wireless Infrastructure
- Cable Downlink Infrastructure
- Point-to-Point and Point-to-Multipoint Data Communications
- High Linearity Frequency Conversion

DESCRIPTION

The LT[®]5519 mixer is designed to meet the high linearity requirements of wireless and cable infrastructure transmission systems. A high speed, internally 50Ω matched, LO amplifier drives a double-balanced mixer core, allowing the use of a low power, single-ended LO source. An RF output transformer is integrated, thus eliminating the need for external matching components at the RF output, while reducing system cost, component count, board area and system-level variations. The IF port can be easily matched to a broad range of frequencies for use in many different applications.

The LT5519 mixer delivers +17.1dBm typical input 3rd order intercept point at 1GHz with IF input signal levels of -10dBm. The input 1dB compression point is typically +5.5dBm. The IC requires only a single 5V supply.

LT, LTC and LT are registered trademarks of Linear Technology Corporation.

TYPICAL APPLICATION

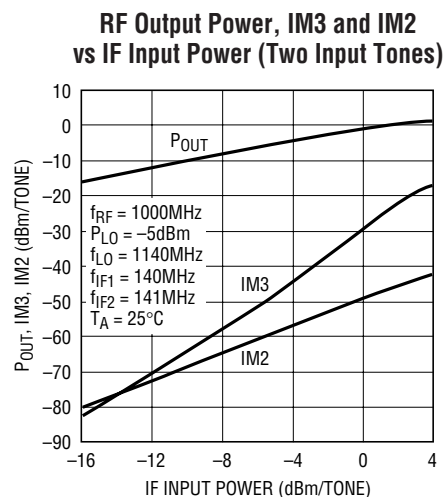
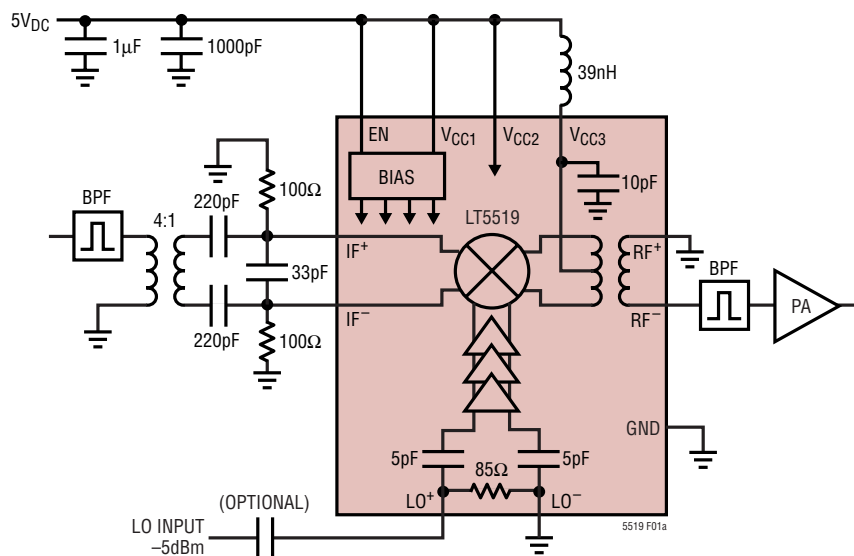

Figure 1. Frequency Conversion in Wireless Infrastructure Transmitter

ABSOLUTE MAXIMUM RATINGS

(Note 1)

Supply Voltage	5.5V
Enable Voltage	-0.3V to ($V_{CC} + 0.3V$)
LO Input Power (Differential)	+10dBm
LO+ to LO- Differential DC Voltage	$\pm 1V$
LO+ and LO- DC Common Mode Voltage	-1V to V_{CC}
IF Input Power (Differential)	+10dBm
IF+ and IF- DC Currents	25mA
RF+ to RF- Differential DC Voltage	$\pm 0.13V$
RF+ and RF- DC Common Mode Voltage	-1V to V_{CC}
Operating Temperature Range	-40°C to 85°C
Storage Temperature Range	-65°C to 125°C
Junction Temperature (T_J)	125°C

PACKAGE/ORDER INFORMATION

<p>TOP VIEW</p> <p>16-LEAD (4mm × 4mm) PLASTIC QFN</p> <p>UF PACKAGE</p> <p>$T_{JMAX} = 125^{\circ}C$, $\theta_{JA} = 37^{\circ}C/W$</p> <p>EXPOSED PAD (PIN 17) IS GND MUST BE SOLDERED TO PCB</p>	ORDER PART NUMBER
	LT5519EUF
	UF PART MARKING
	5519

Consult LTC Marketing for parts specified with wider operating temperature ranges.

ELECTRICAL CHARACTERISTICS

PARAMETER	CONDITIONS	MIN	TYP	MAX	UNITS
IF Input Frequency Range			1 to 400		MHz
LO Input Frequency Range			300 to 1800		MHz
RF Output Frequency Range			700 to 1400		MHz

1GHz Application: $V_{CC} = 5V_{DC}$, EN = High, $T_A = 25^{\circ}C$, IF input = 140MHz at -10dBm, LO input = 1.14GHz at -5dBm, RF output measured at 1GHz, unless otherwise noted. (Test circuit shown in Figure 2) (Notes 2, 3)

PARAMETER	CONDITIONS	MIN	TYP	MAX	UNITS
IF Input Return Loss	$Z_0 = 50\Omega$, with External Matching		20		dB
LO Input Return Loss	$Z_0 = 50\Omega$		17		dB
RF Output Return Loss	$Z_0 = 50\Omega$		20		dB
LO Input Power		-10 to 0			dBm
Conversion Gain			-0.6		dB
Input 3rd Order Intercept	-10dBm/Tone, $\Delta f = 1MHz$		17.1		dBm
Input 2nd Order Intercept	-10dBm, Single Tone		48		dBm
LO to RF Leakage			-44		dBm
LO to IF Leakage			-40		dBm
Input 1dB Compression			5.5		dBm
IF Common Mode Voltage	Internally Biased		1.77		V_{DC}
Noise Figure	Single-Side Band		13.6		dB

DC ELECTRICAL CHARACTERISTICS

(Test Circuit Shown in Figure 2) $V_{CC} = 5V_{DC}$, EN = High, $T_A = 25^\circ C$, unless otherwise noted. (Note 3)

PARAMETER	CONDITIONS	MIN	TYP	MAX	UNITS
Enable (EN) Low = OFF, High = ON					
Turn-On Time (Note 4)			2		μs
Turn-Off Time (Note 4)			6		μs
Input Current	$V_{ENABLE} = 5V_{DC}$		1	10	μA
Enable = High (ON)		3			V_{DC}
Enable = Low (OFF)				0.5	V_{DC}
Power Supply Requirements (V_{CC})					
Supply Voltage			4.5 to 5.25		V_{DC}
Supply Current	$V_{CC} = 5V_{DC}$		60	70	mA
Shutdown Current	EN = Low		1	100	μA

Note 1: Absolute Maximum Ratings are those values beyond which the life of a device may be impaired.

Note 2: External components on the final test circuit are optimized for operation at $f_{RF} = 1GHz$, $f_{LO} = 1.14GHz$ and $f_{IF} = 140MHz$.

Note 3: Specifications over the $-40^\circ C$ to $85^\circ C$ temperature range are assured by design, characterization and correlation with statistical process controls.

Note 4: Turn-On and Turn-Off times are based on the rise and fall times of the RF output envelope from $-40dBm$ to full power with an IF input power of $-10dBm$.

TYPICAL PERFORMANCE CHARACTERISTICS (Test Circuit Shown in Figure 2)

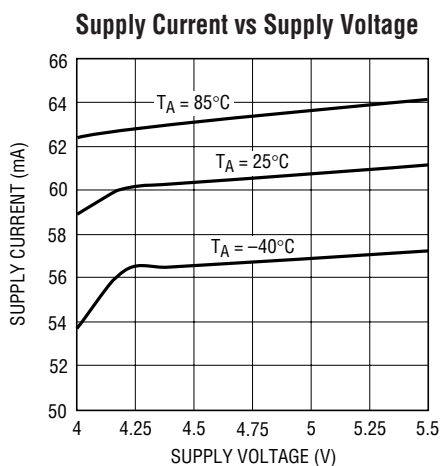

5519 G01

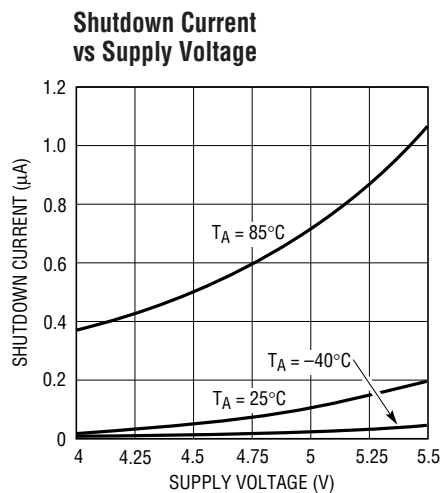

5519 G02

TYPICAL PERFORMANCE CHARACTERISTICS

$V_{CC} = 5V_{DC}$, EN = High, $T_A = 25^\circ C$, IF input = 140MHz at -10dBm, LO input = 1.14GHz at -5dBm, RF output measured at 1000MHz, unless otherwise noted. For 2-tone inputs: 2nd IF input = 141MHz at -10dBm. (Test Circuit Shown in Figure 2.)

Conversion Gain and SSB Noise Figure vs RF Output Frequency

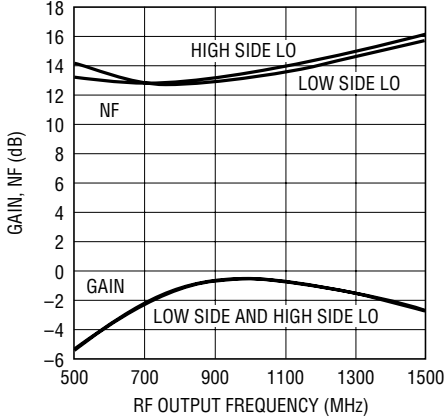

5519 G03

IIP3 and IIP2 vs RF Output Frequency

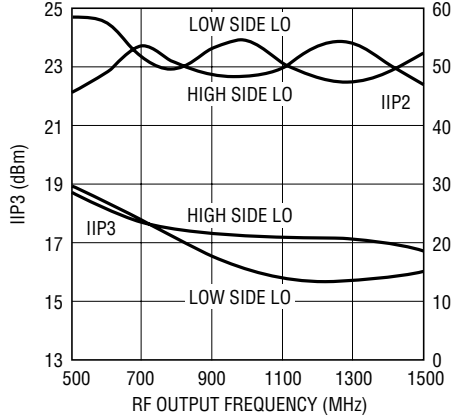

5519 G04

LO-RF Leakage vs RF Output Frequency

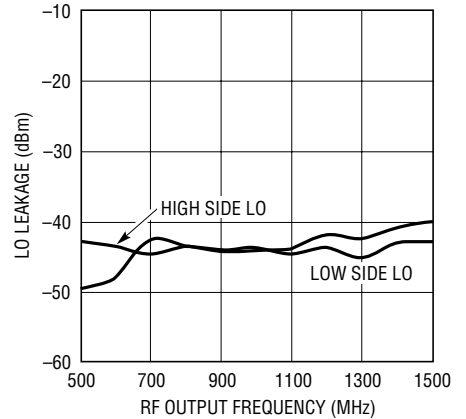

5519 G05

Conversion Gain and SSB Noise Figure vs LO Input Power

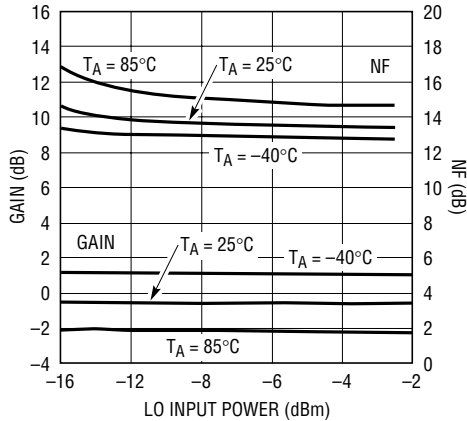

5519 G06

IIP3 and IIP2 vs LO Input Power

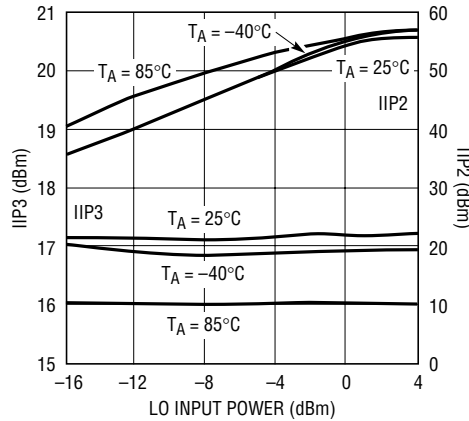

5519 G07

LO-RF Leakage vs LO Input Power

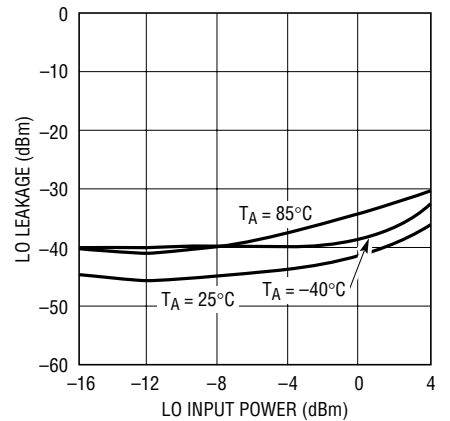

5519 G08

IIP3 and IIP2 vs LO Input Power

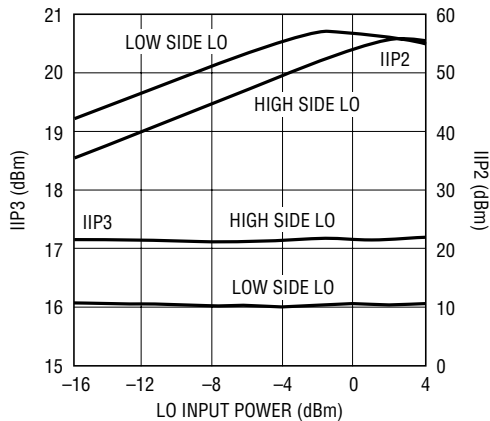

5519 G09

RF Output Power and Output IM3 vs IF Input Power (Two Input Tones)

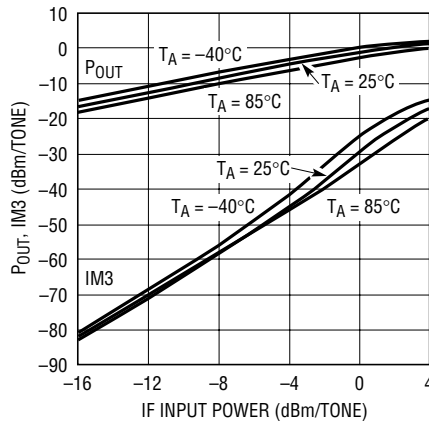

5519 G10

RF Output Power and Output IM2 vs IF Input Power (Two Input Tones)

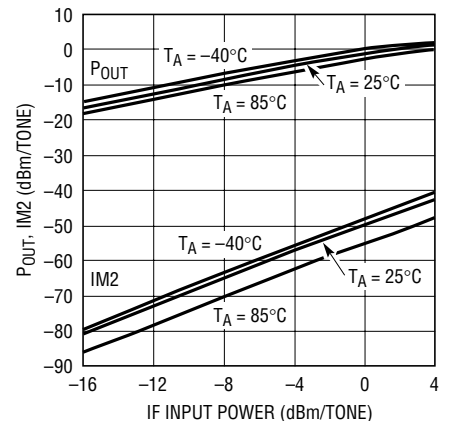

5519 G11

5519 F

TYPICAL PERFORMANCE CHARACTERISTICS

$V_{CC} = 5V_{DC}$, $EN = High$, $T_A = 25^{\circ}C$, IF input = 140MHz at $-10dBm$, LO input = 1.14GHz at $-5dBm$, RF output measured at 1000MHz, unless otherwise noted. For 2-tone inputs: 2nd IF input = 141MHz at $-10dBm$. (Test Circuit Shown in Figure 2.)

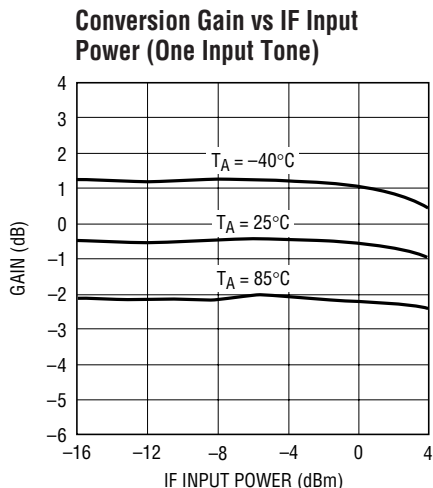

5519 G12

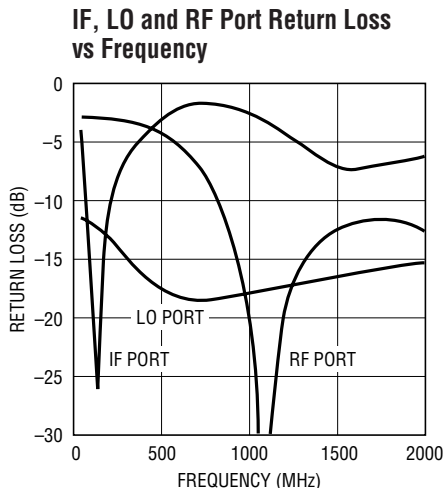

5519 G13

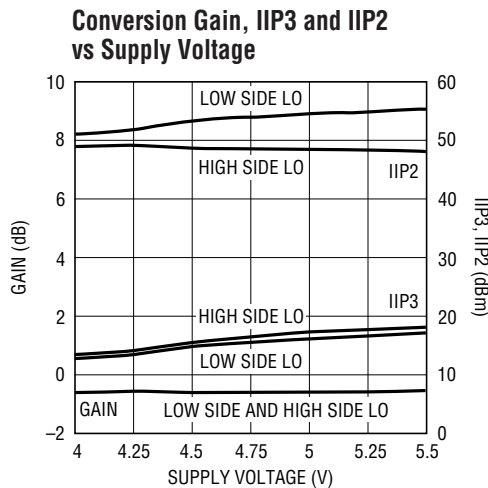

5519 G14

PIN FUNCTIONS

GND (Pins 1, 4, 9, 12, 13, 16): Internal Grounds. These pins are used to improve isolation and are not intended as DC or RF grounds for the IC. Connect these pins to low impedance grounds on the PCB for best performance.

IF⁺, IF⁻ (Pins 2, 3): Differential IF Signal Inputs. A differential signal must be applied to these pins through DC blocking capacitors. The pins must be connected to ground with 100Ω resistors (the grounds must each be capable of sinking about 18mA). For best LO leakage performance, these pins should be DC isolated from each other. An impedance transformation is required to match the IF input to the desired source impedance (typically 50Ω or 75Ω).

EN (Pin 5): Enable Pin. When the applied voltage is greater than 3V, the IC is enabled. When the applied voltage is less than 0.5V, the IC is disabled and the DC current drops to about 1μA.

V_{CC1} (Pin 6): Power Supply Pin for the Bias Circuits. Typical current consumption is about 2mA. This pin should be externally connected to V_{CC} and have appropriate RF bypass capacitors.

V_{CC2} (Pin 7): Power Supply Pin for the LO Buffer Circuits. Typical current consumption is about 22mA. This pin should have appropriate RF bypass capacitors as shown

in Figure 2. The 1000pF capacitor should be located as close to the pins as possible.

V_{CC3} (Pin 8): Power Supply Pin for the Internal Mixer. Typical current consumption is about 36mA. This pin should be externally connected to V_{CC} through an inductor. A 39nH inductor is shown in Figure 2, though the value is not critical.

RF⁻, RF⁺ (Pins 10, 11): Differential RF Outputs. One pin may be DC connected to a low impedance ground to realize a 50Ω single-ended output. No external matching components are required. A DC voltage should not be applied across these pins, as they are internally connected through a transformer winding.

LO⁺, LO⁻ (Pins 14, 15): Differential Local Oscillator Inputs. The LT5519 works well with a single-ended source driving the LO⁺ pin and the LO⁻ pin connected to a low impedance ground. No external 50Ω matching components are required. An internal resistor is connected across these pins; therefore, a DC voltage should not be applied across the inputs.

Exposed Pad (Pin 17): DC and RF ground return for the entire IC. This must be soldered to the printed circuit board low impedance ground plane.

APPLICATIONS INFORMATION

The LT5519 consists of a double-balanced mixer, a high performance LO buffer and bias/enable circuits. The RF and LO ports may be driven differentially; however, they are intended to be used in single-ended mode by connecting one input of each pair to ground. The IF input ports must be DC-isolated from the source and driven differentially. The IF input should be impedance-matched for the desired input frequency. The LO input has an internal broadband 50Ω match with return loss better than 10dB at frequencies up to 1800MHz. The RF output band ranges from 700MHz to 1400MHz, with an internal RF transformer providing a 50Ω impedance match across the band. Low side or high side LO injection can be used.

IF Input Port

The IF inputs are connected to the emitters of the double-balanced mixer transistors, as shown in Figure 3. These pins are internally biased and an external resistor must be connected from each IF pin to ground to set the current through the mixer core. The circuit has been optimized to work with 100Ω resistors, which will result in approximately 18mA of DC current per side. For best LO leakage performance, the resistors should be well matched; thus resistors with 0.1% tolerance are recommended. If LO leakage is not a concern, then lesser tolerance resistors can be used. The symmetry of the layout is also important for achieving optimum LO isolation.

The capacitors shown in Figure 3, C1 and C2, serve two purposes. They provide DC isolation between the IF⁺ and IF⁻ ports, thus preventing DC interactions that could cause unpredictable variations in LO leakage. They also

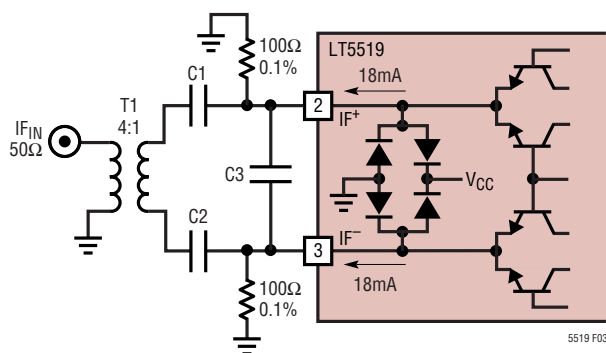

Figure 3. IF Input with External Matching

improve the impedance match by canceling excess inductance in the package and transformer. The input capacitor value required to realize an impedance match at desired frequency, *f*, can be estimated as follows:

$$C_1 = C_2 = \frac{1}{(2\pi f)^2(L_{IN} + L_{EXT})}$$

where; *f* is in units of Hz, *L_{IN}* and *L_{EXT}* are in Henry, and *C₁*, *C₂* are in Farad. *L_{IN}* is the differential input inductance of the LT5519, and is approximately 1.67nH. *L_{EXT}* represents the combined inductances of differential external components and transmission lines. For the evaluation board shown in Figure 10, *L_{EXT}* = 4.21nH. Thus, for *f* = 140MHz, the above formula gives *C₁* = *C₂* = 220pF.

Table 1 lists the differential IF input impedance and reflection coefficient for several frequencies. A 4:1 balun can be used to transform the impedance up to about 50Ω.

Table 1. IF Input Differential Impedance

FREQUENCY (MHz)	DIFFERENTIAL INPUT IMPEDANCE	DIFFERENTIAL S11	
		MAG	ANGLE
10	10.1 + j0.117	0.663	180
44	10.1 + j0.476	0.663	179
70	10.1 + j0.751	0.663	178
140	10.2 + j1.47	0.663	177
170	10.2 + j1.78	0.663	176
240	10.2 + j2.53	0.663	174
360	10.2 + j3.81	0.663	171
500	10.2 + j5.31	0.663	167

LO Input Port

The simplified circuit for the LO buffer input is shown in Figure 4. The LO buffer amplifier consists of high speed limiting differential amplifiers, optimized to drive the mixer quad for high linearity. The LO⁺ and LO⁻ ports can be driven differentially; however, they are intended to be driven by a single-ended source. An internal resistor connected across the LO⁺ and LO⁻ inputs provides a broadband 50Ω impedance match. Because of the resistive match, a DC voltage at the LO input is not recommended. If the LO signal source output is not AC coupled, then a DC blocking capacitor should be used at the LO input.

APPLICATIONS INFORMATION

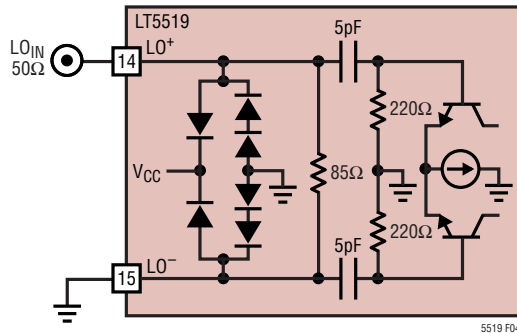

Figure 4. LO Input Circuit

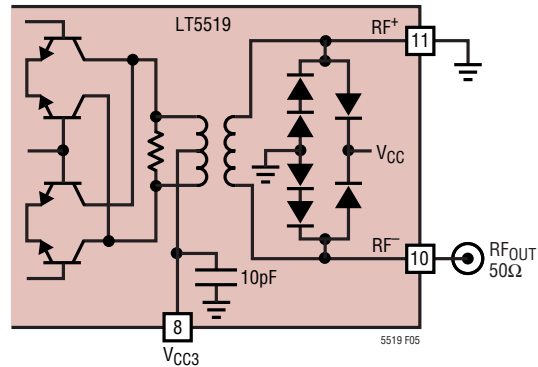

Figure 5. RF Output Circuit

Though the LO input is internally matched to 50Ω, there may be some cases, particularly at higher frequencies or with different source impedances, where a further optimized match is desired. Table 2 includes the single-ended input impedance and reflection coefficient vs frequency for the LO input for use in such cases.

Table 2. Single-Ended LO Input Impedance

FREQUENCY (MHz)	INPUT IMPEDANCE	S11	
		MAG	ANGLE
200	72.3 – j16.1	0.223	–28.4
400	63.3 – j11.3	0.153	–34.7
600	61.6 – j7.5	0.124	–29.2
800	61.9 – j6.0	0.119	–23.6
1000	62.7 – j6.1	0.125	–22.7
1200	63.2 – j7.4	0.134	–25.5
1400	63.3 – j9.5	0.144	–30.8
1600	62.8 – j12.0	0.155	–37.1
1800	61.6 – j14.2	0.163	–43.4

RF Output Port

An internal RF transformer, shown in Figure 5, reduces the mixer-core impedance to provide an impedance of 50Ω across the RF+ and RF- pins. The LT5519 is designed and tested with the outputs configured for single-ended operation, as shown in the Figure 5; however, the outputs can be used differentially as well. A center tap in the transformer provides the DC connection to the mixer core and the transformer provides DC isolation at the RF output. The

RF+ and RF- pins are connected together through the secondary windings of the transformer; thus a DC voltage should not be applied across these pins.

The impedance data for the RF output, listed in Table 3, can be used to develop matching networks for different load impedances.

Table 3. Single-Ended RF Output Impedance

FREQUENCY (MHz)	OUTPUT IMPEDANCE	S11	
		MAG	ANGLE
700	27.6 + j32.0	0.465	103
800	39.7 + j32.1	0.354	88.1
900	50.9 + j23.5	0.227	74.7
1000	53.5 + j10.3	0.105	65.5
1100	48.3 + j1.3	0.022	143
1200	42.0 – j3.1	0.093	–157
1300	36.6 – j3.4	0.159	–164
1400	33.0 – j2.0	0.207	–172

Operation at Different Input Frequencies

On the evaluation board shown in Figure 10, the input of the LT5519 can be easily matched for different frequencies by changing the capacitors, C1, C2 and C3. Capacitors C1 and C2 set the input matching frequency while C3 improves the LO to RF leakage performance. Decreasing the value of C3 at higher input frequencies reduces its impact on conversion gain. Table 4 lists some actual values used at selected frequencies.

APPLICATIONS INFORMATION

Table 4. Input Capacitor Values vs Frequency

FREQUENCY (MHz)	CAPACITANCE (C1, C2) (pF)	CAPACITANCE (C3) (pF)
44	2200	33
70	820	33
140	220	33
240	68	15
300	39	6.8
350	27	6.8
440	18	6.8

The performance was evaluated with the input tuned for each of these frequencies and the results are summarized in Figures 6-8. The same IF input balun transformer was used for all measurements. In each case, the LO input

frequency was adjusted to maintain an RF output frequency of 1000MHz.

Low Frequency Matching of the RF Output Port

Without any external components on the RF output, the internal transformer of the LT5519 provides a good 50Ω impedance match for RF frequencies above approximately 850MHz. Below this frequency, the return loss drops below 10dB and degrades the conversion gain. The addition of a single 10pF capacitor in series with the RF output improves the match at lower RF frequencies, shifting the 10dB return loss point to about 700MHz, as demonstrated in Figure 9. This change also results in an improvement of the conversion gain.

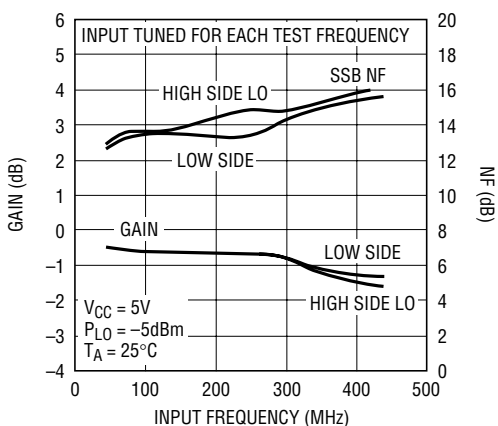

5519 F06

Figure 6. Conversion Gain and Single Sideband Noise Figure vs Tuned IF Input Frequency

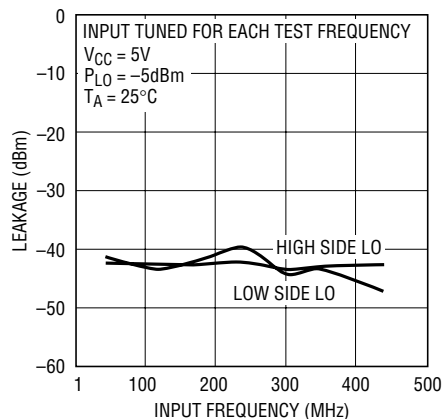

5519 F08

Figure 8. LO to RF Leakage vs Tuned IF Input Frequency

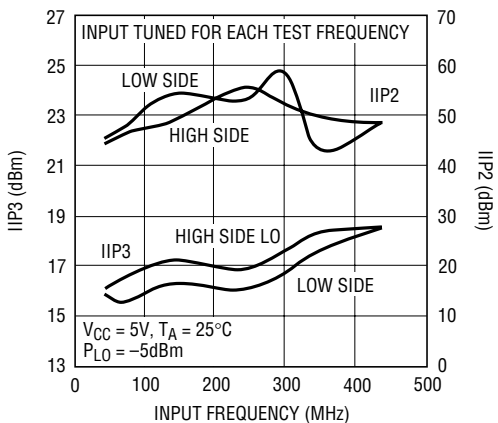

5519 F07

Figure 7. IIP3 and IIP2 vs Tuned IF Input Frequency

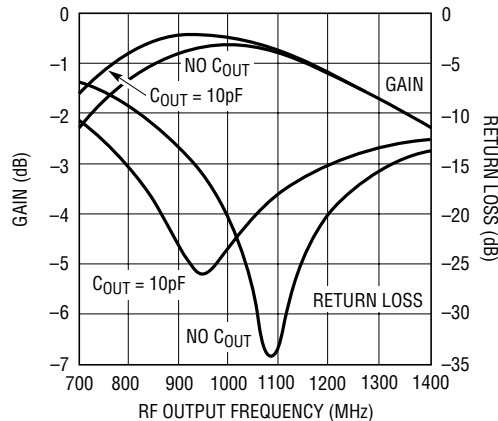

5519 F09

Figure 9. Conversion Gain and Return Loss vs Output Frequency

TYPICAL APPLICATIONS

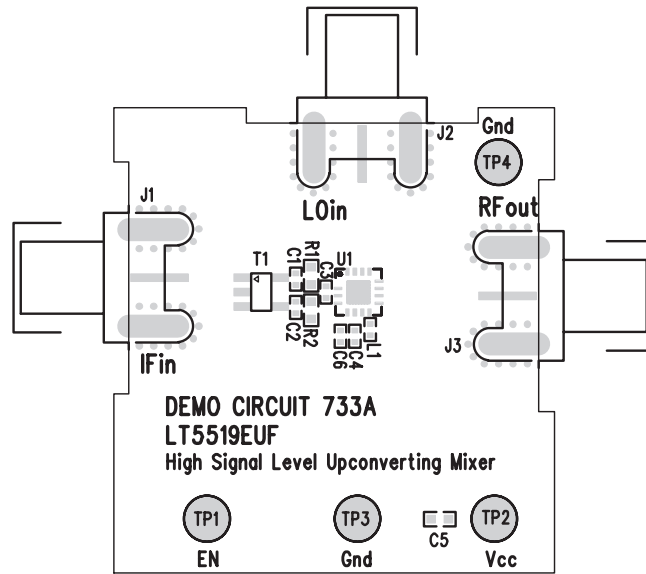

(10a) Top Layer Silkscreen

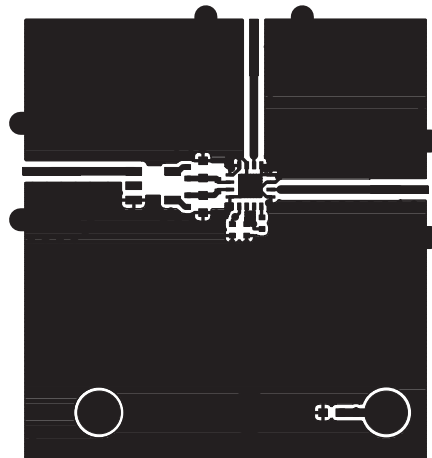

(10b) Top Layer Metal

Figure 10. Evaluation Board Layout

PACKAGE DESCRIPTION

UF Package
16-Lead Plastic QFN (4mm × 4mm)
 (Reference LTC DWG # 05-08-1692)

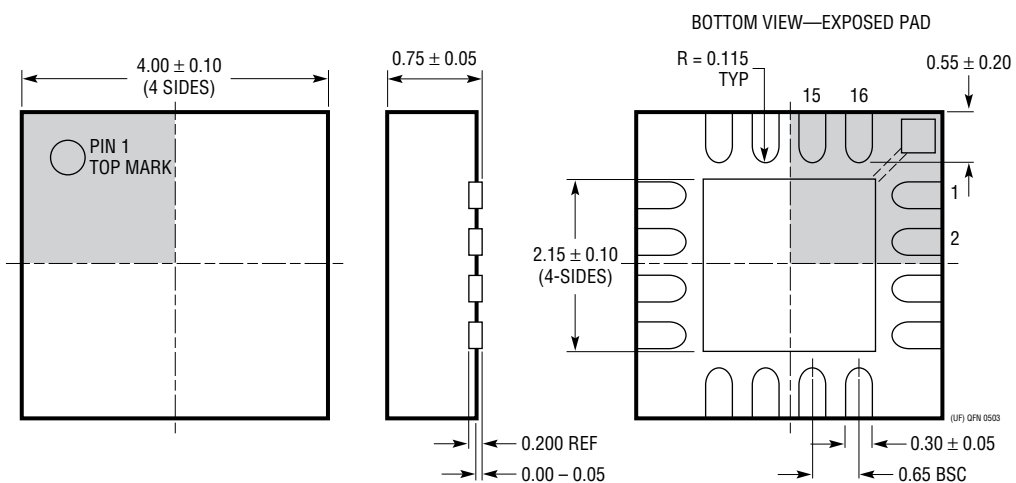
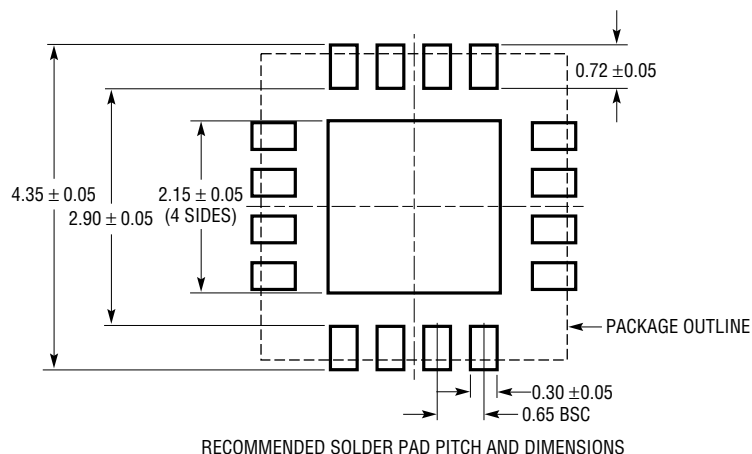

- NOTE:
1. DRAWING CONFORMS TO JEDEC PACKAGE OUTLINE MO-220 VARIATION (WGGC)
 2. ALL DIMENSIONS ARE IN MILLIMETERS
 3. DIMENSIONS OF EXPOSED PAD ON BOTTOM OF PACKAGE DO NOT INCLUDE MOLD FLASH. MOLD FLASH, IF PRESENT, SHALL NOT EXCEED 0.15mm ON ANY SIDE
 4. EXPOSED PAD SHALL BE SOLDER PLATED

RELATED PARTS

PART NUMBER	DESCRIPTION	COMMENTS
Infrastructure		
LT5511	High Signal Level Upconverting Mixer	RF Output to 3GHz, 17dBm IIP3, Integrated LO Buffer
LT5512	DC-3GHz High Signal Level Downconverting Mixer	RF Input to 3GHz, 21dBm IIP3, Integrated LO Buffer
LT5515	1.5GHz to 2.5GHz Direct Conversion Quadrature Demodulator	20dBm IIP3, Integrated LO Quadrature Generator
LT5516	0.8GHz to 1.5GHz Direct Conversion Quadrature Demodulator	21.5dBm IIP3, Integrated LO Quadrature Generator
LT5517	40MHz to 900MHz Direct Conversion Quadrature Demodulator	21dBm IIP3, Integrated LO Quadrature Generator
LT5520	1.3GHz to 2.3GHz High Linearity Upconverting Mixer	15.9dBm IIP3, Single Ended, 50Ω Matched RF and LO Ports
LT5522	600MHz to 2.7GHz High Signal Level Downconverting Mixer	4.5V to 5.25V Supply, 25dBm IIP3 at 900MHz, NF = 12.5dB, 50Ω Single-Ended RF and LO Ports
RF Power Detectors		
LT5504	800MHz to 2.7GHz RF Measuring Receiver	80dB Dynamic Range, Temperature Compensated, 2.7V to 5.25V Supply
LTC5505	300MHz to 3GHz RF Power Detectors	LTC5505-1: -28dBm to +18dBm Range, LTC5505-2: -32dBm to +12dBm Range, Temperature Compensated, 2.7V to 6V Supply
LTC5507	100kHz to 1000MHz RF Power Detector	-34dBm to +14dBm Range, Temperature Compensated, 2.7V to 6V Supply
LTC5508	300MHz to 7GHz RF Power Detector	-32dBm to +12dBm Range, Temperature Compensated, SC70 Package
LTC5509	300MHz to 3GHz RF Power Detector	36dB Dynamic Range, Temperature Compensated, SC70 Package
LTC5532	300MHz to 7GHz Precision RF Power Detector	Precision V_{OUT} Offset Control, Adjustable Gain and Offset
RF Building Blocks		
LT5500	1.8GHz to 2.7GHz Receiver Front End	1.8V to 5.25V Supply, Dual-Gain LNA, Mixer LO Buffer
LT5502	400MHz Quadrature IF Demodulator with RSSI	1.8V to 5.25V Supply, 70MHz to 400MHz IF, 84dB Limiting Gain, 90dB RSSI Range
LT5503	1.2GHz to 2.7GHz Direct IQ Modulator and Upconverting Mixer	1.8V to 5.25V Supply, Four-Step RF Power Control, 120MHz Modulation Bandwidth
LT5506	500MHz Quadrature IF Demodulator with VGA	1.8V to 5.25V Supply, 40MHz to 500MHz IF, -4dB to 57dB Linear Power Gain, 8.8MHz Baseband Bandwidth
LT5546	500MHz Quadrature IF Demodulator with VGA and 17MHz Baseband Bandwidth	1.8V to 5.25V Supply, 40MHz to 500MHz IF, -7dB to 56dB Linear Power Gain