

Full-Swing Input and Output type Dual Operational Amplifier

■ GENERAL DESCRIPTION

NJM2732 is dual operational amplifier with full swing input and output, operate from 1.8V.
 Input and Output Full Swing provides wide dynamic range, is from ground to power supply level. In addition to ground sensing applications, NJM2732 enable to be applied to Hi-side sensing applications.

The features are low noise and low operating voltage for battery management, portable audio applications, and others.

■ FEATURES

- Operating Voltage : 1.8 to 6.0V
- Input Full-Swing : $V_{ICM} = 0$ to 5.0V, at $V^+ = 5V$
- Output Full-Swing : $V_{OH} \geq 4.9V$ / $V_{OL} \leq 0.1V$, at $V^+ = 5V$, $R_L = 20k\Omega$
- Load Drivability : $V_{OH} \geq 4.75V$ / $V_{OL} \leq 0.25V$, at $V^+ = 5V$, $R_L = 2k\Omega$
- Offset Voltage : 5mV max.
- Slew Rate : 0.4V/ μ s typ.
- Low Input Voltage Noise : 10nV/ \sqrt{Hz} typ.
- Adequate phase margin : $\Phi_M = 75$ deg. typ., at $R_L = 2k\Omega$, voltage follower
- Bipolar Technology
- Package Outline : DIP8, DMP8, EMP8, SSOP8, TVSP8

■ PACKAGE OUTLINE

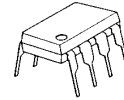

NJM2732D



NJM2732M



NJM2732E



NJM2732V



NJM2732RB1

■ PIN CONFIGURATION

(Top View)

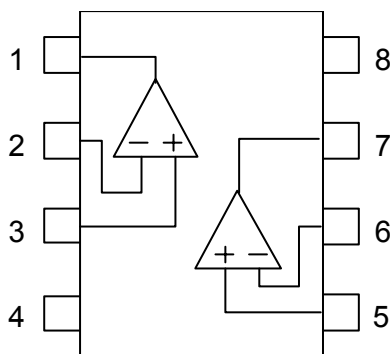

PIN FUNCTION

- 1. A OUTPUT
- 2. A -INPUT
- 3. A +INPUT
- 4. GND
- 5. B +INPUT
- 6. B -INPUT
- 7. B OUTPUT
- 8. V⁺

- NJM2732D
- NJM2732M
- NJM2732E
- NJM2732V
- NJM2732RB1

NJM2732

■ ABSOLUTE MAXIMUM RATINGS

(Ta=25°C)

| PARAMETER | SYMBOL | RATINGS | UNIT |
|----------------------------------|-----------|--|------|
| Supply Voltage | V^+ | 7.0 | V |
| Differential Input Voltage Range | V_{ID} | ± 1.0 | V |
| Common Mode Input Voltage Range | V_{IC} | 0 ~ 7.0 (Note1) | V |
| Power Dissipation | P_D | (DIP8) 500 (DMP8) 300 (EMP8) 320 (SSOP8) 250 (TVSP8) 320 | mW |
| Operating Temperature Range | T_{opr} | -40~+85 | °C |
| Storage Temperature Range | T_{stg} | -40~+125 | °C |

(Note1) For supply voltage less than 7V, the absolute maximum input voltage is equal to the supply voltage.

■ RECOMMENDED OPERATING CONDITION

(Ta=25°C)

| PARAMETER | SYMBOL | RATING | UNIT |
|----------------|--------|------------|------|
| Supply Voltage | V^+ | 1.8 to 6.0 | V |

■ ELECTRICAL CHARACTERISTICS ($V^+=5V$, Ta=25°C)

●DC CHARACTERISTICS

($V^+=5V$, Ta=25°C)

| PARAMETER | SYMBOL | TEST CONDITION | MIN. | TYP. | MAX. | UNIT |
|---------------------------------|-----------|--|------|------|------|---------|
| Operating Current | I_{CC} | No signal applied | - | 580 | 900 | μA |
| Input Offset Voltage | V_{IO} | | - | 1 | 5 | mV |
| Input Bias Current | I_B | | - | 50 | 250 | nA |
| Input Offset Current | I_{IO} | | - | 5 | 100 | nA |
| Large Signal Voltage Gain | A_V | $R_L=2k\Omega$ | 60 | 85 | - | dB |
| Common Mode Rejection Ratio | CMR | CMR+: $2.5V \leq V_{CM} \leq 5V$ CMR-: $0V \leq V_{CM} \leq 2.5V$ (Note2) | 55 | 70 | - | dB |
| Supply Voltage Rejection Ratio | SVR | $V^+/V = \pm 2.0V \sim \pm 3.0V$ | 70 | 85 | - | dB |
| Maximum Output Voltage 1 | V_{OH1} | $R_L=20k\Omega$ | 4.9 | 4.95 | - | V |
| | V_{OL1} | $R_L=20k\Omega$ | - | 0.05 | 0.1 | V |
| Maximum Output Voltage 2 | V_{OH2} | $R_L=2k\Omega$ | 4.75 | 4.85 | - | V |
| | V_{OL2} | $R_L=2k\Omega$ | - | 0.15 | 0.25 | V |
| Input Common Mode Voltage Range | V_{ICM} | CMR ≥ 55 dB | 0 | - | 5 | V |

(Note2) CMR is represented by either CMR+ or CMR- has lower value.

CMR+ is measured with $2.5V \leq V_{CM} \leq 5.0$ and CMR- is measured with $0V \leq V_{CM} \leq 2.5V$.

●AC CHARACTERISTICS

($V^+=5V$, Ta=25°C)

| PARAMETER | SYMBOL | TEST CONDITION | MIN. | TYP. | MAX. | UNIT |
|--------------------------------|----------|----------------|------|------|------|-----------------|
| Unity Gain Bandwidth | GB | $R_L=2k\Omega$ | - | 1 | - | MHz |
| Phase Margin | Φ_M | $R_L=2k\Omega$ | - | 75 | - | Deg |
| Equivalent Input Noise Voltage | V_{NI} | $f=1kHz$ | - | 10 | - | nV/ \sqrt{Hz} |

●TRANSIENT CHARACTERISTICS

($V^+=5V$, Ta=25°C)

| PARAMETER | SYMBOL | TEST CONDITION | MIN. | TYP. | MAX. | UNIT |
|-----------|--------|----------------|------|------|------|------------|
| Slew Rate | SR | $R_L=2k\Omega$ | - | 0.4 | - | V/ μs |

■ ELECTRICAL CHARACTERISTICS ($V^+=3V, T_a=25^\circ C$)

●DC CHARACTERISTICS

($V^+=3V, T_a=25^\circ C$)

| PARAMETER | SYMBOL | TEST CONDITION | MIN. | TYP. | MAX. | UNIT |
|---------------------------------|-----------|--|------|------|------|---------|
| Operating Current | I_{CC} | No signal applied | - | 510 | 880 | μA |
| Input Offset Voltage | V_{IO} | | - | 1 | 5 | mV |
| Input Bias Current | I_B | | - | 50 | 250 | nA |
| Input Offset Current | I_{IO} | | - | 5 | 100 | nA |
| Large Signal Voltage Gain | A_V | $R_L=2k\Omega$ | 60 | 84 | - | dB |
| Common Mode Rejection Ratio | CMR | CMR+: $1.5V \leq V_{CM} \leq 3V$ CMR-: $0V \leq V_{CM} \leq 1.5V$ (Note3) | 48 | 63 | - | dB |
| Supply Voltage Rejection Ratio | SVR | $V^+V^-=\pm 1.2V \sim \pm 2.0V$ | 68 | 83 | - | dB |
| Maximum Output Voltage 1 | V_{OH1} | $R_L=20k\Omega$ | 2.9 | 2.95 | - | V |
| | V_{OL1} | $R_L=20k\Omega$ | - | 0.05 | 0.1 | V |
| Maximum Output Voltage 2 | V_{OH2} | $R_L=2k\Omega$ | 2.75 | 2.85 | - | V |
| | V_{OL2} | $R_L=2k\Omega$ | - | 0.15 | 0.25 | V |
| Input Common Mode Voltage Range | V_{ICM} | CMR ≥ 48 dB | 0 | - | 3 | V |

(Note3) CMR is represented by either CMR+ or CMR-has lower value.

CMR+ is measured with $1.5V \leq V_{CM} \leq 3.0$ and CMR- is measured with $0V \leq V_{CM} \leq 1.5V$.

●AC CHARACTERISTICS

($V^+=3V, T_a=25^\circ C$)

| PARAMETER | SYMBOL | TEST CONDITION | MIN. | TYP. | MAX. | UNIT |
|--------------------------------|----------|----------------|------|------|------|----------------|
| Unity Gain Bandwidth | GB | $R_L=2k\Omega$ | - | 1 | - | MHz |
| Phase Margin | Φ_M | $R_L=2k\Omega$ | - | 75 | - | Deg |
| Equivalent Input Noise Voltage | V_{NI} | $f=1kHz$ | - | 10 | - | nV/\sqrt{Hz} |

●TRANSIENT CHARACTERISTICS

($V^+=3V, T_a=25^\circ C$)

| PARAMETER | SYMBOL | TEST CONDITION | MIN. | TYP. | MAX. | UNIT |
|-----------|--------|----------------|------|------|------|------------|
| Slew Rate | SR | $R_L=2k\Omega$ | - | 0.35 | - | V/ μs |

■ ELECTRICAL CHARACTERISTICS ($V^+=1.8V, T_a=25^\circ C$)

●DC CHARACTERISTICS

($V^+=1.8V, T_a=25^\circ C$)

| PARAMETER | SYMBOL | TEST CONDITION | MIN. | TYP. | MAX. | UNIT |
|---------------------------------|-----------|--|------|------|------|---------|
| Operating Current | I_{CC} | No signal applied | - | 460 | 800 | μA |
| Input Offset Voltage | V_{IO} | | - | 1 | 5 | mV |
| Input Bias Current | I_B | | - | 50 | 250 | nA |
| Input Offset Current | I_{IO} | | - | 5 | 100 | nA |
| Large Signal Voltage Gain | A_V | $R_L=2k\Omega$ | 60 | 83 | - | dB |
| Common Mode Rejection Ratio | CMR | CMR+: $0.9V \leq V_{CM} \leq 1.8V$ CMR-: $0V \leq V_{CM} \leq 0.9V$ (Note4) | 48 | 55 | - | dB |
| Supply Voltage Rejection Ratio | SVR | $V^+V^-=\pm 1.2V \sim \pm 2.0V$ | 65 | 80 | - | dB |
| Maximum Output Voltage 1 | V_{OH1} | $R_L=20k\Omega$ | 1.7 | 1.75 | - | V |
| | V_{OL1} | $R_L=20k\Omega$ | - | 0.05 | 0.1 | V |
| Maximum Output Voltage 2 | V_{OH2} | $R_L=2k\Omega$ | 1.55 | 1.65 | - | V |
| | V_{OL2} | $R_L=2k\Omega$ | - | 0.15 | 0.25 | V |
| Input Common Mode Voltage Range | V_{ICM} | CMR ≥ 40 dB | 0 | - | 1.8 | V |

(Note4) CMR is represented by either CMR+ or CMR-has lower value.

CMR+ is measured with $0.9V \leq V_{CM} \leq 1.8$ and CMR- is measured with $0V \leq V_{CM} \leq 0.9V$.

●AC CHARACTERISTICS

($V^+=1.8V, T_a=25^\circ C$)

| PARAMETER | SYMBOL | TEST CONDITION | MIN. | TYP. | MAX. | UNIT |
|--------------------------------|----------|----------------|------|------|------|----------------|
| Unity Gain Bandwidth | GB | $R_L=2k\Omega$ | - | 1 | - | MHz |
| Phase Margin | Φ_M | $R_L=2k\Omega$ | - | 75 | - | Deg |
| Equivalent Input Noise Voltage | V_{NI} | $f=1kHz$ | - | 10 | - | nV/\sqrt{Hz} |

●TRANSIENT CHARACTERISTICS

($V^+=1.8V, T_a=25^\circ C$)

| PARAMETER | SYMBOL | TEST CONDITION | MIN. | TYP. | MAX. | UNIT |
|-----------|--------|----------------|------|------|------|------------|
| Slew Rate | SR | $R_L=2k\Omega$ | - | 0.3 | - | V/ μs |

■ TYPICAL CHARACTERISTICS

Operating Current vs Operating Voltage

$G_V=0\text{dB}$, $T_a=25^\circ\text{C}$

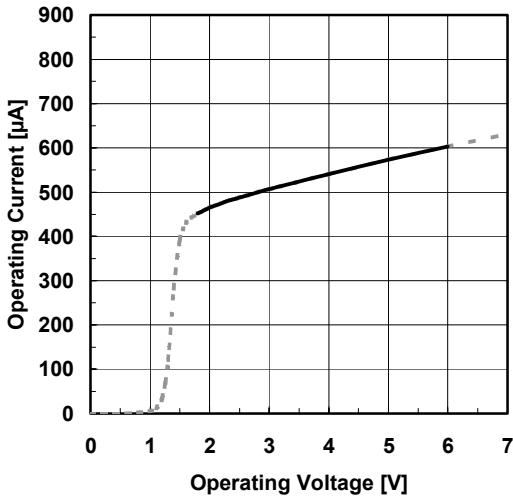

Operating Current vs. Operating Voltage (correlation with T_a)

$G_V=0\text{dB}$, $T_a=25^\circ\text{C}$

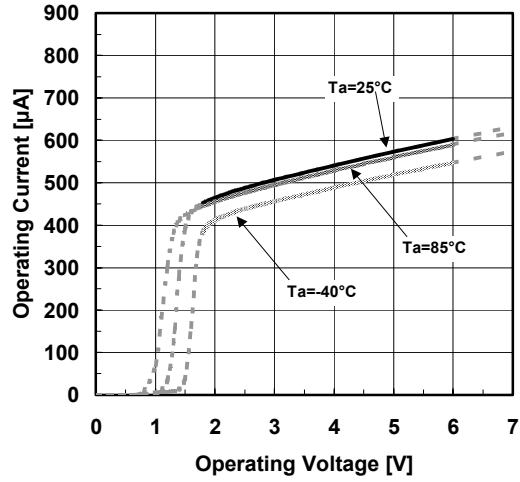

Operating Current vs. Ambient Temperature

$G_V=0\text{dB}$

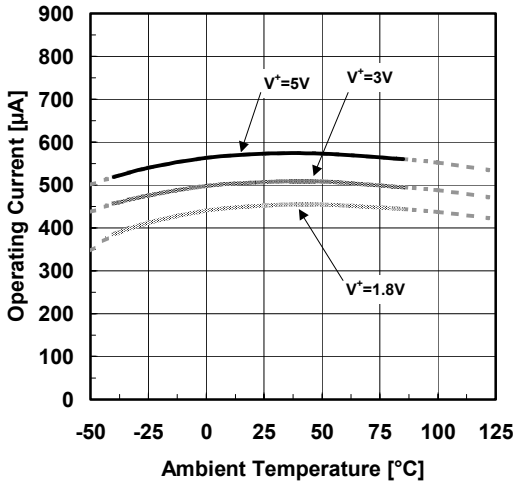

Input Offset Voltage vs. Ambient Temperature

$G_V=0\text{dB}$

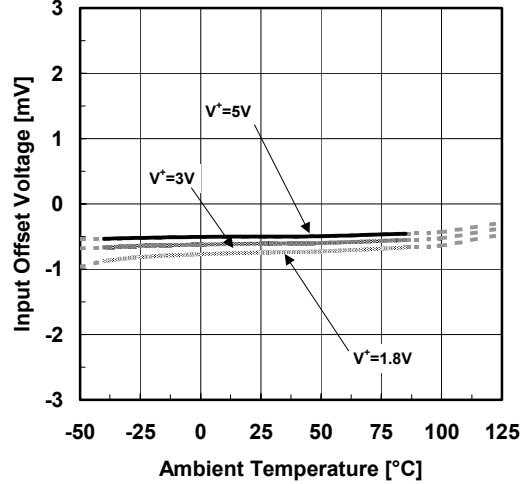

Input Bias Current vs. Ambient Temperature

$G_V=0\text{dB}$

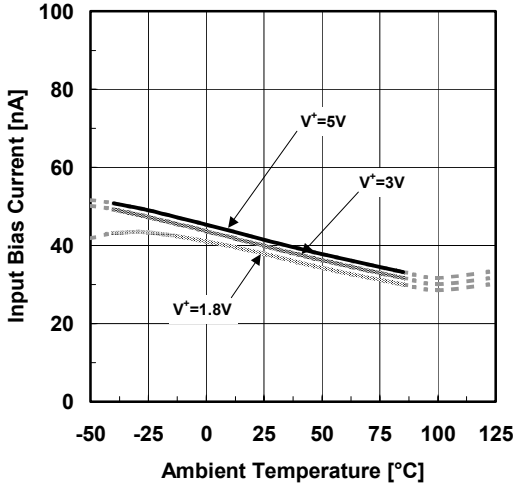

Input Offset Current vs. Ambient Temperature

$G_V=0\text{dB}$

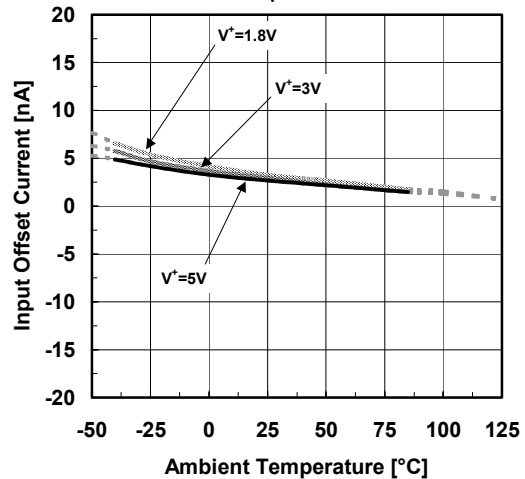

■ TYPICAL CHARACTERISTICS

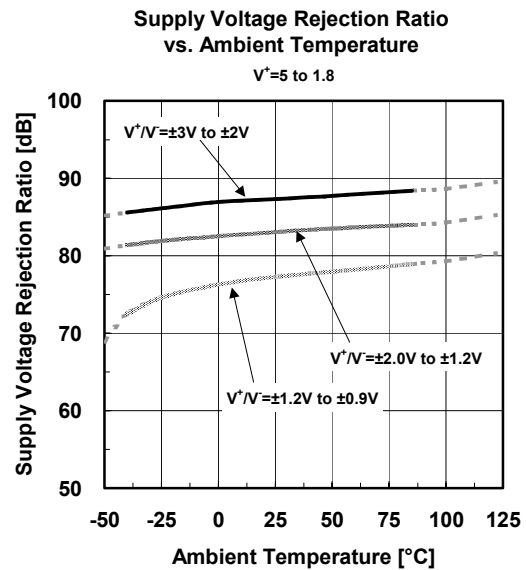
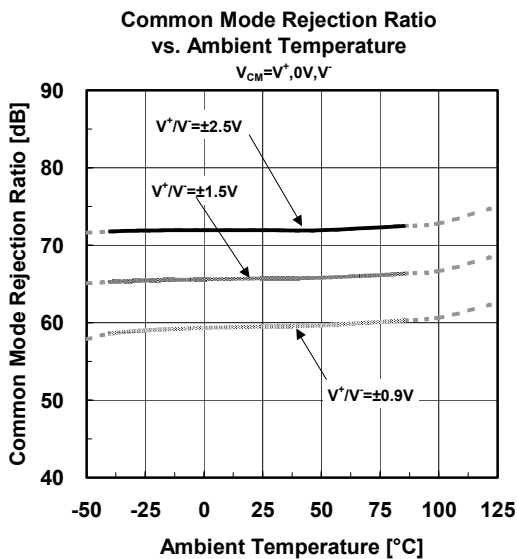
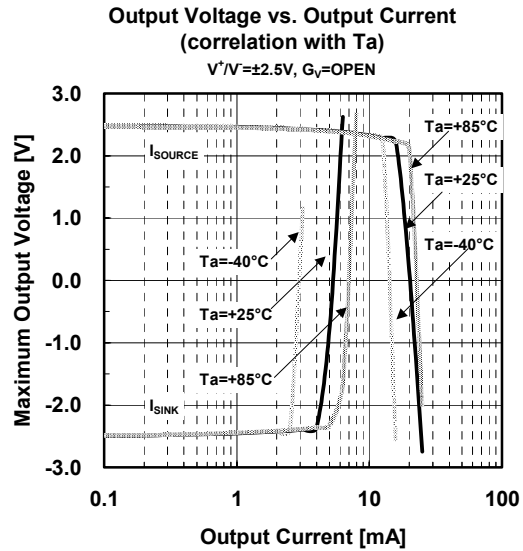
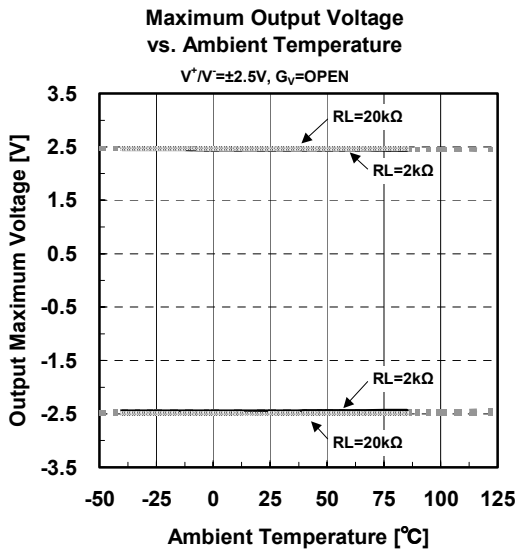
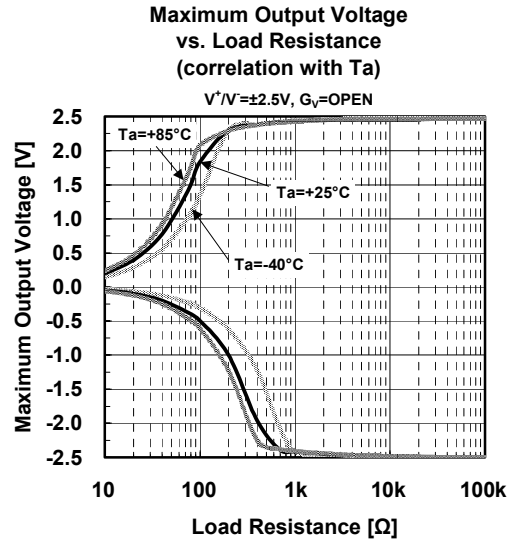
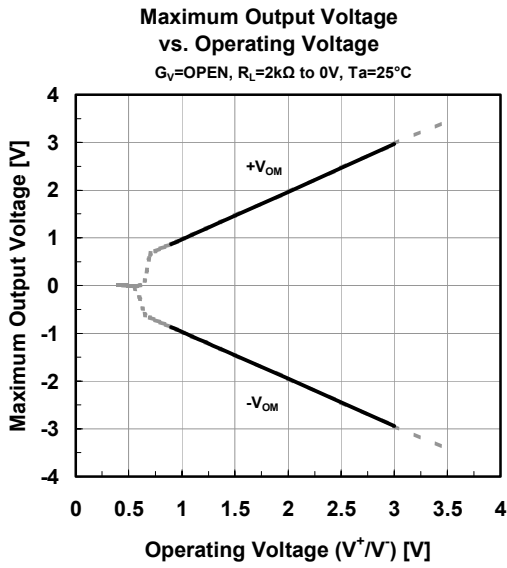

■ TYPICAL CHARACTERISTICS

Voltage Gain/Phase vs. Frequency
(with Capacitive load)

$V^+ / V^- = \pm 2.5V$, $G_V = 40dB$, $R_F = 2k\Omega$,
 $R_G = 20\Omega$, $R_L = 2k\Omega$, $T_a = +25^\circ C$

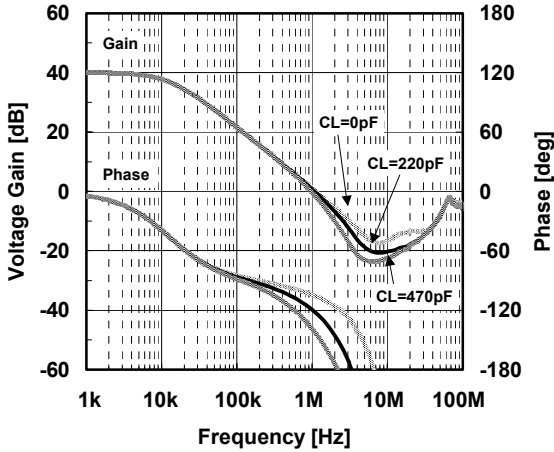

Voltage Gain/Phase vs. Frequency
(correlation with T_a)

$V^+ / V^- = \pm 2.5V$, $G_V = 40dB$,
 $R_F = 2k\Omega$, $R_G = 20\Omega$, $R_L = 2k\Omega$, $C_L = 0pF$

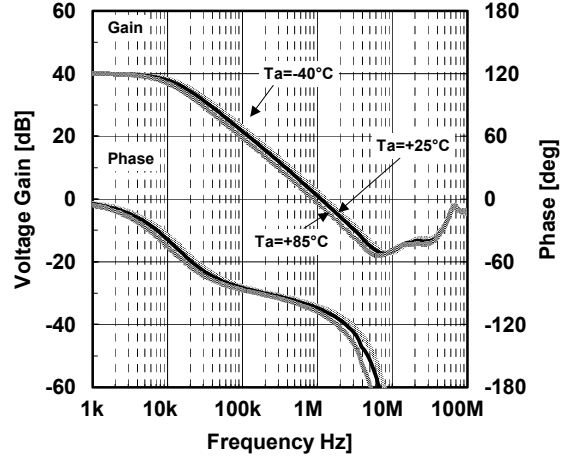

Phase Margin vs. Load Capacitance
(with Capacitance Load)

$V^+ / V^- = \pm 1.5V$, $G_V = 40dB$, $R_F = 2k\Omega$,
 $R_G = 20\Omega$, $R_L = 2k\Omega$, $T_a = +25^\circ C$

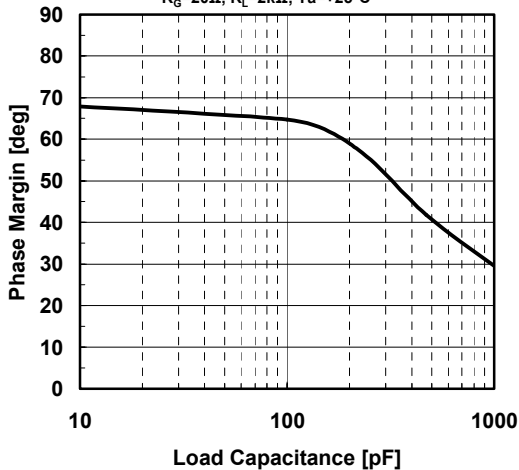

Voltage Gain vs. Frequency
(correlation with T_a)

$V^+ / V^- = \pm 2.5V$, $G_V = 0dB$, $C_L = 100pF$,
 $R_S = 50\Omega$, $R_L = 2k\Omega$

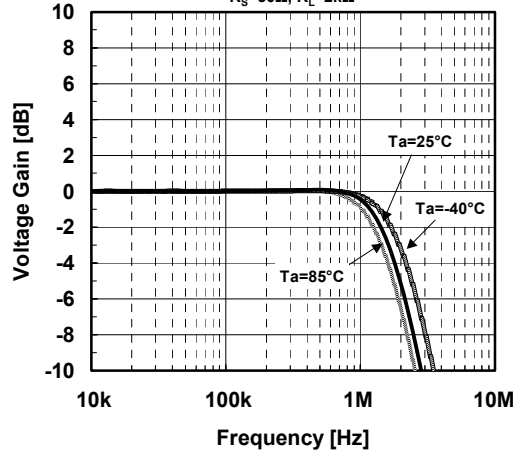

Voltage Gain vs. Frequency
(with Capacitance Load)

$V^+ / V^- = \pm 2.5V$, $G_V = 0dB$,
 $R_S = 50\Omega$, $R_L = 2k\Omega$, $T_a = +25^\circ C$

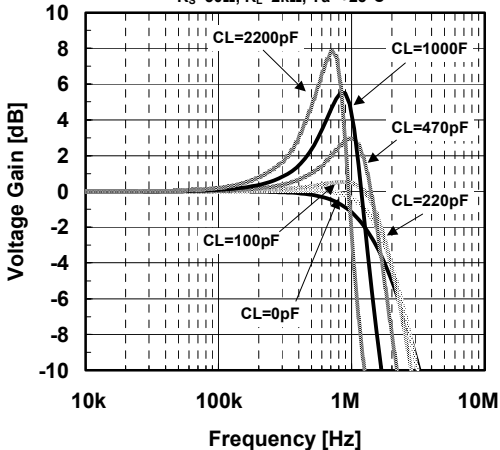

Voltage Gain vs. Frequency
(correlation with T_a)

$V^+ / V^- = \pm 2.5V$, $G_V = 0dB$, $C_L = 1000pF$,
 $R_S = 50\Omega$, $R_L = 2k\Omega$

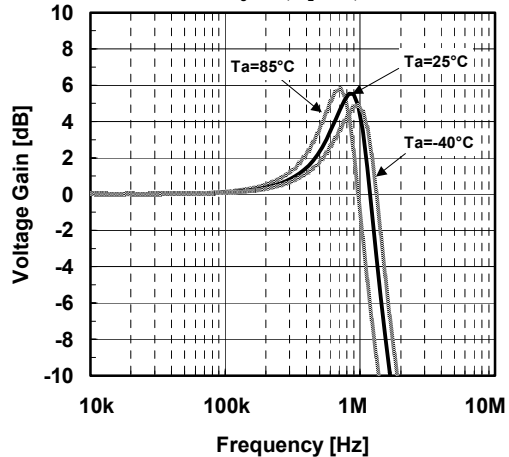

■ TYPICAL CHARACTERISTICS

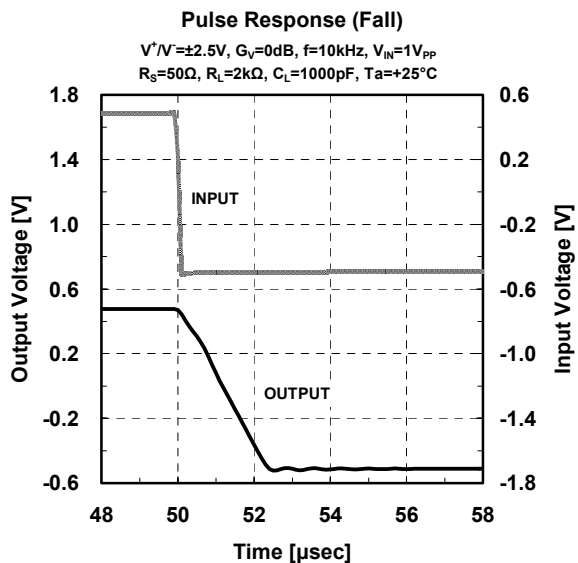
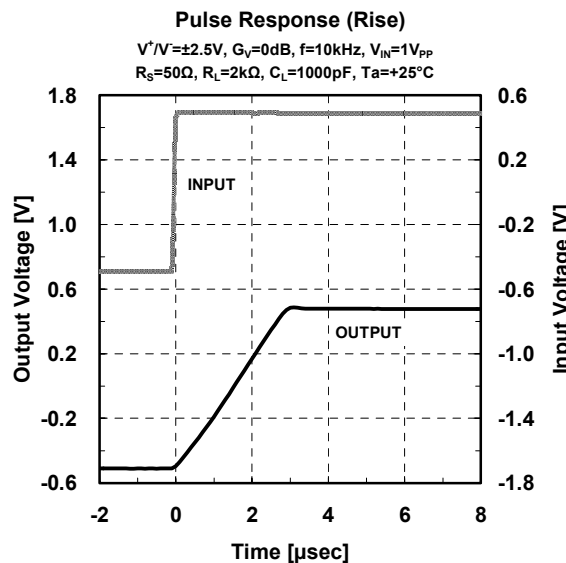
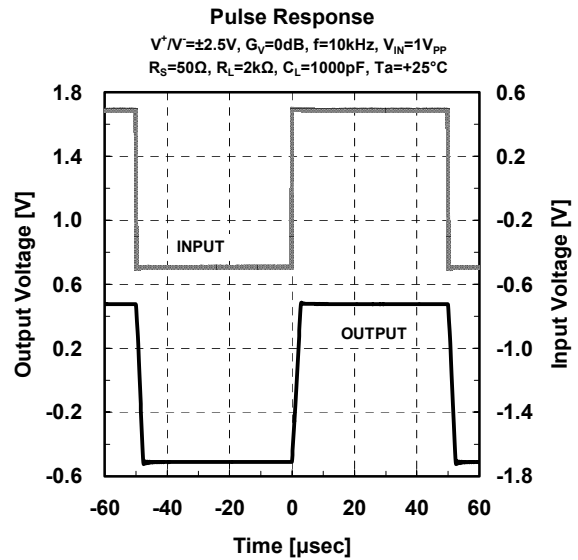
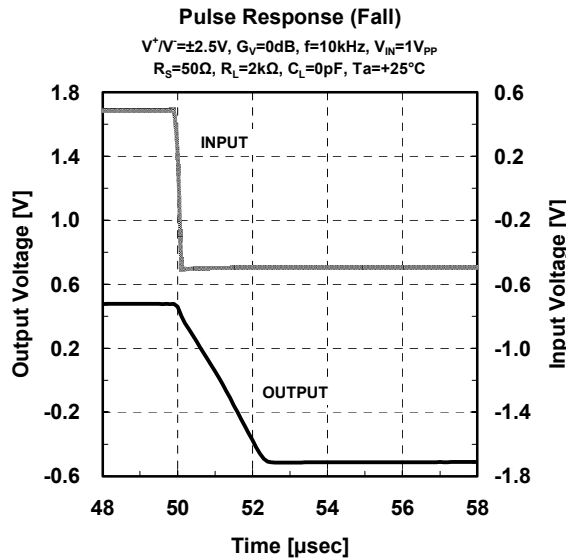
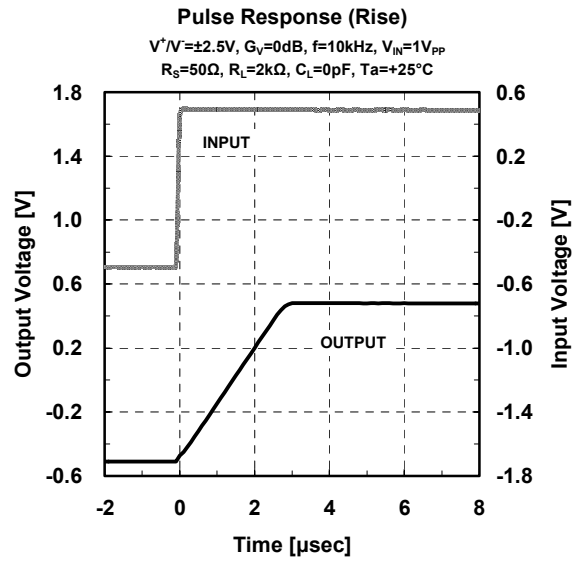
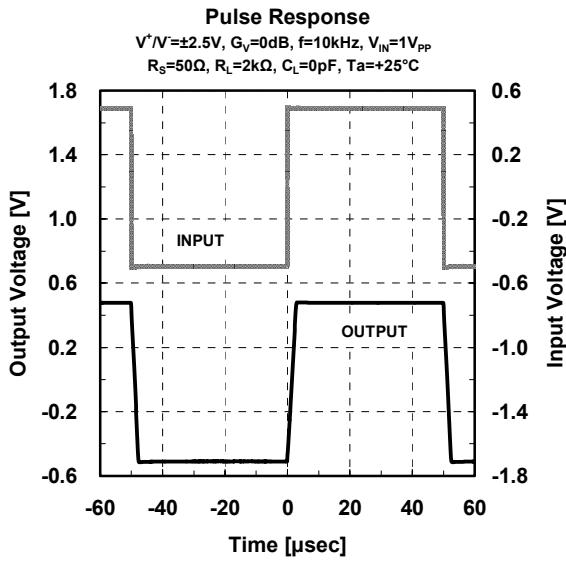

■ TYPICAL CHARACTERISTICS

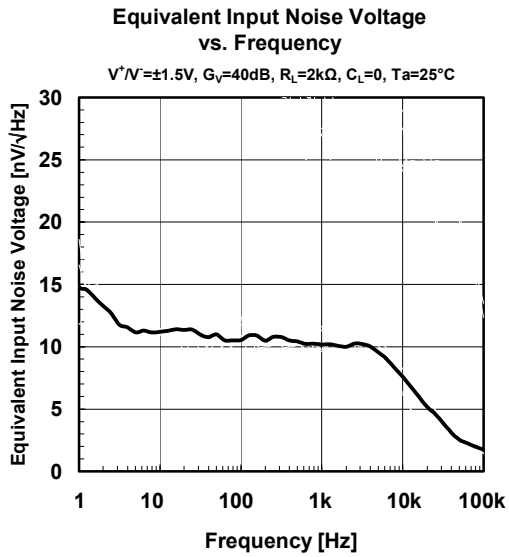
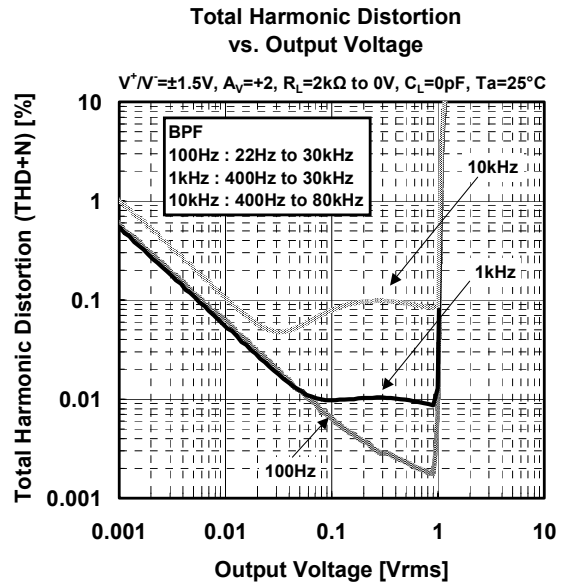
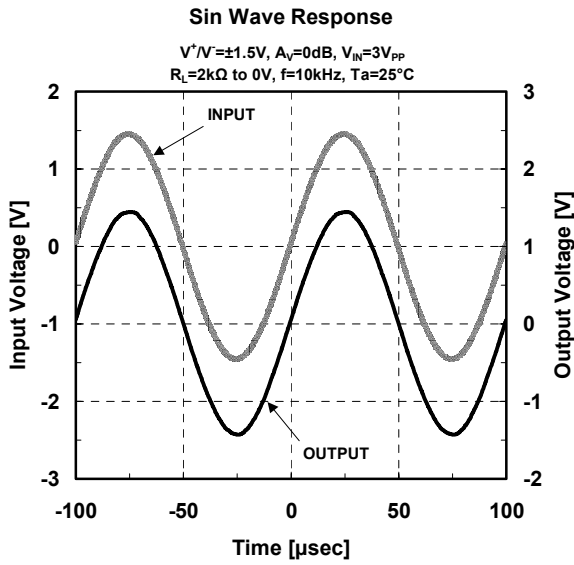

[CAUTION]

The specifications on this databook are only given for information, without any guarantee as regards either mistakes or omissions. The application circuits in this databook are described only to show representative usages of the product and not intended for the guarantee or permission of any right including the industrial rights.