

K-No.: 25151

125A / 200A Current Sensor

 For the electronic measurement of currents:
 DC, AC, pulsed, mixed ..., with a galvanic isolation
 between the primary circuit (high power)
 and the secondary circuit (electronic circuit)

Date: 17.04.2013

Customer: Standard type

Customers Part no.:

Page 1 of 2

Description

- Closed loop (compensation) Current Sensor with magnetic field probe
- Printed circuit board mounting
- Casing and materials UL-listed

Characteristics

- Excellent accuracy
- Very low offset current
- Very low temperature dependency and offset current drift
- Very low hysteresis of offset current
- Short response time
- Wide frequency bandwidth
- Compact design
- Reduced offset ripple

Applications

Mainly used for stationary operation in industrial applications:

- AC variable speed drives and servo motor drives
- Static converters for DC motor drives
- Battery supplied applications
- Switched Mode Power Supplies (SMPS)
- Power Supplies for welding applications
- Uninterruptable Power Supplies (UPS)

Electrical data – Ratings

I_{PN}	Primary nominal r.m.s. current	125/200	A
R_M	Measuring resistance $V_C = \pm 12V$	0 ... 250	Ω
	$V_C = \pm 15V$	10...400	Ω
I_{SN}	Secondary nominal r.m.s. current	62,5/100	mA
K_N	Turns ratio	1: 2000	

Accuracy – Dynamic performance data

		min.	typ.	max.	Unit
$I_{P,max}$	Max. measuring range				
	@ $V_C = \pm 12V, R_M = 10 \Omega (t_{max} = 10sec)$	± 290			A
	@ $V_C = \pm 15V, R_M = 10 \Omega (t_{max} = 10sec)$	± 370			A
X	Accuracy @ $I_{PN}, T_A = 25^\circ C$		0.1	0.5	%
ϵ_L	Linearity			0.1	%
I_0	Offset current @ $I_P = 0, T_A = 25^\circ C$		0.02	0.05	mA
t_r	Response time		1		μs
$\Delta t (I_{P,max})$	Delay time at $di/dt = 100 A/\mu s$		0.5		μs
f	Frequency bandwidth	DC...100			kHz

General data

		min.	typ.	max.	Unit
T_A	Ambient operating temperature	-40		+85	$^\circ C$
T_S	Ambient storage temperature	-40		+90	$^\circ C$
m	Mass		37		g
V_C	Supply voltage	± 11.4	$\pm 12/\pm 15$	± 15.75	V
I_C	Current consumption		18		mA
	Constructed and manufactured and tested in accordance with EN 61800-5-1 (Pin 1- 4 to inner hole) Reinforced insulation, Insulation material group 1, Pollution degree 2				
S_{clear}	Clearance (component without solder pad)	12			mm
S_{creep}	Creepage (component without solder pad)	12			mm
V_{sys}	System voltage overvoltage category 3	RMS		600	V
V_{work}	Working voltage (table 7 acc. to EN61800-5-1)	RMS		1000	V
U_{PD}	Rated discharge voltage	peak value		1225	V

Max. potential difference acc. to UL 508	RMS	600	V_{AC}
--	-----	-----	----------

Maximal continuous and peak currents at defined temperatures

 Supply voltage $\pm 12V$:

T_A	85 $^\circ C$	85 $^\circ C$	70 $^\circ C$	55 $^\circ C$
I_P	200 A	250 A	250 A	250 A
$I_{P,max}$	264 A	295 A	306 A	343 A
R_M	20 Ω	10 Ω	10 Ω	5 Ω

 Supply voltage $\pm 15V$:

T_A	85 $^\circ C$	85 $^\circ C$	70 $^\circ C$	55 $^\circ C$
I_P	200 A	150 A	230 A	250 A
$I_{P,max}$	333 A	384 A	389 A	433 A
R_M	20 Ω	10 Ω	10 Ω	5 Ω

Date	Name	Issue	Amendment
17.04.13	KRe.	81	Mechanical outline: marking with UL-sign and max. potential difference added. CN-654
20.10.10	Le	81	Mechanical outline – Error correction – distance of fastening bores (41,4 to 40,64) lapidary change.

Hrsg.: KB-E editor	Bearb.: Le designer	KB-PM IA: KRe. check	freig.: HS released
-----------------------	------------------------	-------------------------	------------------------

K-No.: 25151

125A / 200A Current Sensor

For the electronic measurement of currents:
DC, AC, pulsed, mixed ..., with a galvanic isolation
between the primary circuit (high power)
and the secondary circuit (electronic circuit)

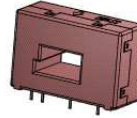

Date: 17.04.2013

Customer: Standard type

Customers Part no.:

Page 2 of 2

Mechanical outline (mm):

General tolerances DIN ISO 2768-c

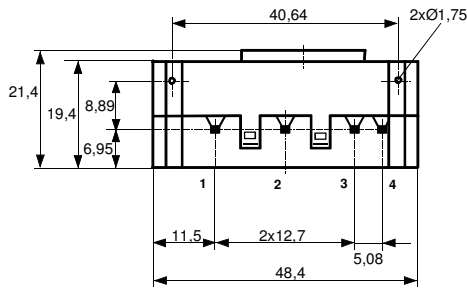

Tolerances grid distance
±0,2mm

DC = Date Code
F = Factory

*= preliminary

Connections:

1...4: 0,6 x 0,88 mm

Marking:

UL-sign
4646X201
F DC

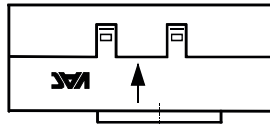
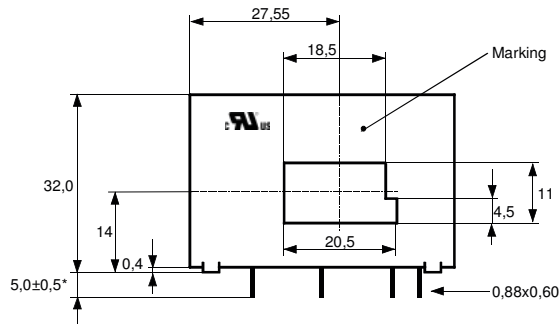

Schematic diagram

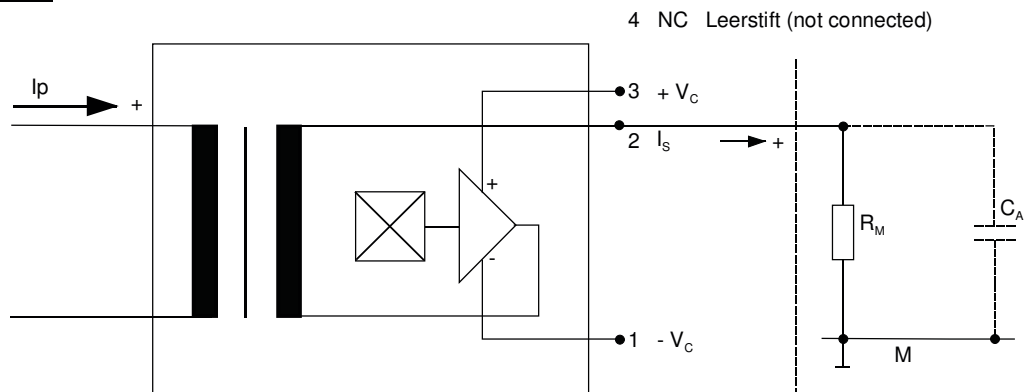

Temperature of the primary conductor should not exceed 110°C
Additional indications are obtainable on request.
This specification is no declaration of warranty acc. BGB §443 dar.

Hrsg.: KB-E
editor

Bearb.: Le
designer

KB-PM IA: KRe.
check

freig.: HS
released

K-No.: 25151

125A / 200A Current Sensor

 For electronic current measurement:
 DC, AC, pulsed, mixed ..., with a galvanic
 isolation between primary circuit
 (high power) and secondary circuit

Date: 17.04.2013

Customer:

Customers Part No.:

Page 1 of 3

Electrical Data (investigate by a type checking)

		min.	typ.	max.	Unit
V_{Ctot}	Maximum supply voltage (without function) ± 15.75 to ± 18 V: for 1s per hour			± 18	V
R_S	Secondary coil resistance @ $T_A=85^\circ\text{C}$			63	Ω
X_{Ti}	Temperature drift of X @ $T_A = -40 \dots +85^\circ\text{C}$			0.1	%
I_{0ges}	Offset current (including I_0, I_{0t}, I_{0T})			0.07	mA
I_{0t}	Long term drift Offset current I_0		0.025		mA
I_{0T}	Offset current temperature drift I_0 @ $T_A = -40 \dots +85^\circ\text{C}$		0.025		mA
I_{0H}	Hysteresis current @ $I_P=0$ (caused by primary current $10 \times I_{PN}$)		0.025	0.05	mA
$\Delta I_0/\Delta V_C$	Supply voltage rejection ratio			0.01	mA/V
i_{loss}	Offset ripple (with 1 MHz- filter first order)			0.1	mA
i_{loss}	Offset ripple (with 100 kHz- filter first order)		0.01	0.02	mA
i_{loss}	Offset ripple (with 20 kHz- filter first order)		0.003	0.005	mA
C_k	Maximum possible coupling capacity (primary – secondary)		8		pF

Inspection (Measurement after temperature balance of the samples at room temperature)

$K_N(N_1/N_2)$	(V)	M3011/6	Transformation ratio ($I_P=100\text{A}$, 40-80 Hz)	1:1990...2010	
I_0	(V)	M3226	Offset current	0.05	mA
V_d	(V)	M3014:	Test voltage, rms, 1 s pin 1 – 4 vs. hole	1.8	kV
V_e	(AQL 1/S4)		Partial discharge voltage acc.M3024 (RMS) with V_{vor} (RMS)	1300 1625	V V

Type Testing (Pin 1 - 4 to hole)

V_W			HV transient test according to M3064 (1,2 μs / 50 μs -wave form)	8	kV
V_d			Testing voltage to M3014 (5 s)	3.6	kV
V_e			Partial discharge voltage acc.M3024 (RMS) with V_{vor} (RMS)	1300 1625	V V

Datum	Name	Index	Änderung
17.04.13	KRe.	81	Applicable documents: further standards added. CN-654
20.10.10	Le	81	Date updated.

 Hrsg.: KB-E
 editor

 Bearb.: Le
 designer

 KB-PM IA: KRe.
 check

 freig.: HS
 released

K-No.: 25151

125A / 200A Current Sensor

For electronic current measurement:
DC, AC, pulsed, mixed ..., with a galvanic
isolation between primary circuit
(high power) and secondary circuit

Date: 17.04.2013

Customer:

Customers Part No.:

Page 2 of 3

Limit curve of measurable current $\hat{I}_p(R_M)$

@ ambient temperature $\leq 85\text{ }^\circ\text{C}$

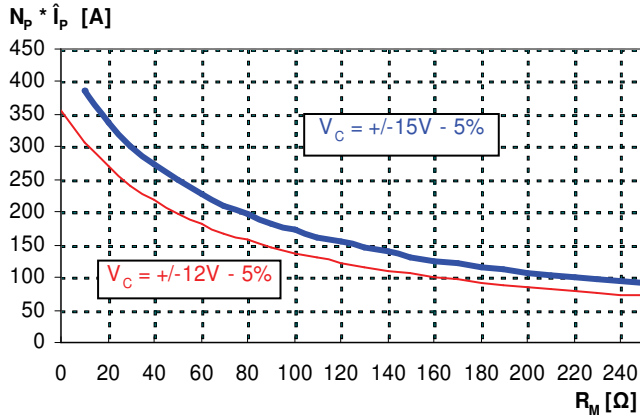

Maximum measuring range (μs -range)

Output current behaviour of a 3kA current pulse
@ $V_C = \pm 15\text{V}$ und $R_M = 10\Omega$

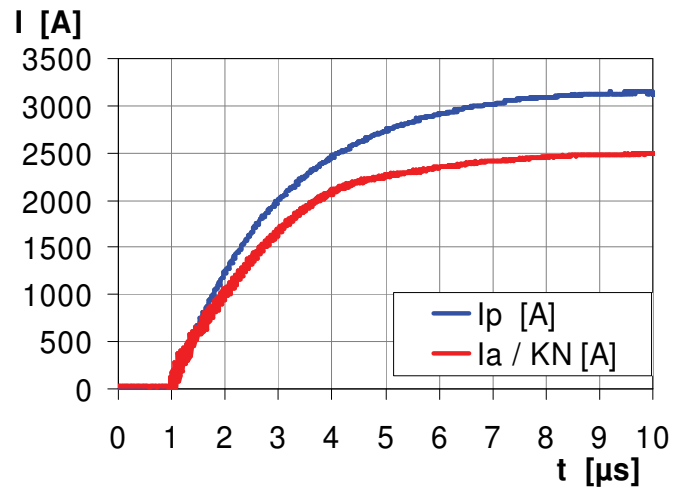

Fast increasing currents (higher than the specified $I_{p,max}$), e.g. in case of a short circuit, can be transmitted because the currents are transformed directly and be limited by diodes only.

The offset ripple can be reduced by an external low pass. Simplest solution is a passive low pass filter of 1st order with

$$f_g = \frac{1}{2\pi \cdot R_M \cdot C_a}$$

In this case the response time is enlarged.

It is calculated from:

$$t'_r \leq t_r + 2,5R_M C_a$$

Applicable documents

Current direction: A positive output current appears at point I_s , by primary current in direction of the arrow.
Further standards UL 508 ; file E317483, category NMTR2 / NMTR8

Hrsg.: KB-E
editor

Bearb.: Le
designer

KB-PM IA: KRe.
check

freig.: HS
released

K-No.: 25151

125A / 200A Current Sensor

For electronic current measurement:
DC, AC, pulsed, mixed ..., with a galvanic
isolation between primary circuit
(high power) and secondary circuit

Date: 17.04.2013

Customer:

Customers Part No.:

Page 3 of 3

Explanation of several of the terms used in the tablets (in alphabetical order)

I_{0H} : Zero variation after overloading with a DC of tenfold the rated value ($R_M = R_{MN}$)

I_{0t} : Long term drift of I_0 after 100 temperature cycles in the range -40 bis 85 °C.

t_r : Response time, measured as delay time at $I_P = 0,8 \cdot I_{Pmax}$ between a rectangular current and the output current.

$\Delta t (I_{Pmax})$: Delay time between I_{Pmax} and the output current i_a with a primary current rise of $di_1/dt = 100 \text{ A}/\mu\text{s}$.

U_{PD} Rated discharge voltage (recurring peak voltage separated by the insulation) proved with a sinusoidal voltage V_e
 $U_{PD} = \sqrt{2} \cdot V_e / 1,5$

V_{vor} Defined voltage is the RMS value of a sinusoidal voltage with peak value of $1,875 \cdot U_{PD}$ required for partial discharge test in IEC 61800-5-1
 $V_{vor} = 1,875 \cdot U_{PD} / \sqrt{2}$

V_{sys} System voltage RMS value of rated voltage according to IEC 61800-5-1

V_{work} Working voltage voltage according to IEC 61800-5-1 which occurs by design in a circuit or across insulation

$X_{ges}(I_{PN})$: The sum of all possible errors over the temperature range by measuring a current I_{PN} :

$$X_{ges} = 100 \cdot \left| \frac{I_S(I_{PN})}{K_N \cdot I_{PN}} - 1 \right|$$

X: Permissible measurement error in the final inspection at RT, defined by

$$X = 100 \cdot \left| \frac{I_{SB}}{I_{SN}} - 1 \right|$$

where I_{SB} is the output DC value of an input DC current of the same magnitude as the (positive) rated current ($I_0 = 0$)

X_{Ti} : Temperature drift of the rated value orientated output term. I_{SN} (cf. Notes on F_i) in a specified temperature range, obtained by:

$$X_{Ti} = 100 \cdot \left| \frac{I_{SB}(T_{A2}) - I_{SB}(T_{A1})}{I_{SN}} \right|$$

ϵ_L : Linearity fault defined by $\epsilon_L = 100 \cdot \left| \frac{I_P}{I_{PN}} - \frac{I_{Sx}}{I_{SN}} \right|$

Where I_P is any input DC and I_{Sx} the corresponding output term. I_{SN} : see notes of F_i ($I_0 = 0$).

This "Additional information" is no declaration of warranty according BGB §443.

Hrsg.: KB-E
editor

Bearb.: Le
designer

KB-PM IA: KRe.
check

freig.: HS
released