

G3VM-401BY/EY

MOS FET Relays

Analog-switching MOS FET Relays with a Dielectric Strength of 5 kVAC between I/O Using Optical Isolation.

- Switches minute analog signals.
- Leakage current of 1 μA max. when output relay is open.

RoHS compliant

Application Examples

- Communication equipment
- Test & Measurement equipment
- Industrial equipment

List of Models

Package type	Contact form	Terminals	Load voltage (peak value) *	Model	Minimum package quantity	
					Number per tube	Number per tape and reel
DIP6	1a (SPST-NO)	PCB Terminals	400 V	G3VM-401BY	50	-
		Surface-mounting Terminals		G3VM-401EY (TR)		

* The AC peak and DC value are given for the load voltage.

Absolute Maximum Ratings (Ta = 25°C)

Item	Symbol	Rating	Unit	Measurement conditions		
Input	LED forward current	I _F	50	mA		
	Repetitive peak LED forward current	I _{FP}	1	A	100 μs pulses, 100 pps	
	LED forward current reduction rate	$\Delta I_F / ^\circ\text{C}$	-0.5	mA/ $^\circ\text{C}$	Ta $\geq 25^\circ\text{C}$	
	LED reverse voltage	V _R	5	V		
	Connection temperature	T _J	125	$^\circ\text{C}$		
Output	Load voltage (AC peak/DC)	V _{OFF}	400	V		
	Continuous load current	I _o	Connection A	120	mA	Connection A: AC peak/DC Connection B and C: DC
			Connection B	120		
			Connection C	240		
	ON current reduction rate	$\Delta I_o / ^\circ\text{C}$	Connection A	-1.2	mA/ $^\circ\text{C}$	Ta $\geq 25^\circ\text{C}$
			Connection B	-1.2		
Connection C			-2.4			
Connection temperature	T _J	125	$^\circ\text{C}$			
Dielectric strength between I/O (See note 1.)	V _{I-O}	5000	V _{rms}	AC for 1 min		
Ambient operating temperature	T _a	-40 to +85	$^\circ\text{C}$	With no icing or condensation		
Ambient storage temperature	T _{stg}	-55 to +125	$^\circ\text{C}$	With no icing or condensation		
Soldering temperature	-	260	$^\circ\text{C}$	10 s		

Note: 1. The dielectric strength between the input and output was checked by applying voltage between all pins as a group on the LED side and all pins as a group on the light-receiving side.

Connection Diagram

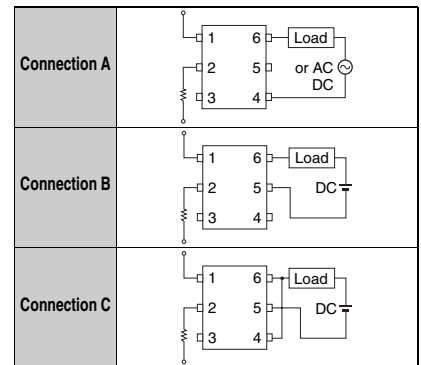

Electrical Characteristics (Ta = 25°C)

Item	Symbol	Minimum	Typical	Maximum	Unit	Measurement conditions		
Input	LED forward voltage	V _F	1.0	1.15	1.3	V	I _F = 10 mA	
	Reverse current	I _R	-	-	10	μA	V _R = 5 V	
	Capacity between terminals	C _T	-	30	-	pF	V = 0, f = 1 MHz	
	Trigger LED forward current	I _{FT}	-	-	3	mA	I _o = 120 mA	
Output	Maximum resistance with output ON	R _{ON}	Connection A	-	17	35	Ω	I _F = 5 mA, I _o = 120 mA
			Connection B	-	11	20	Ω	I _F = 5 mA, I _o = 120 mA
			Connection C	-	6	10	Ω	I _F = 5 mA, I _o = 240 mA
	Current leakage when the relay is open	I _{LEAK}	-	-	1.0	μA	V _{OFF} = 400 V	
	Capacity between terminals	C _{OFF}	-	40	-	pF	V = 0, f = 1 MHz	
Capacity between I/O terminals	C _{I-O}	-	0.8	-	pF	f = 1 MHz, V _S = 0 V		
Insulation resistance between I/O terminals	R _{I-O}	1000	-	-	M Ω	V _{I-O} = 500 VDC, R _{oH} $\leq 60\%$		
Turn-ON time	t _{ON}	-	0.3	1.0	ms	I _F = 5 mA, R _L = 200 Ω , V _{DD} = 20 V (See note 2.)		
Turn-OFF time	t _{OFF}	-	0.1	1.0	ms			

Note: 2. Turn-ON and Turn-OFF Times

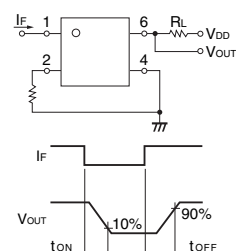

Recommended Operating Conditions

Use the G3VM under the following conditions so that the Relay will operate properly.

Item	Symbol	Minimum	Typical	Maximum	Unit
Load voltage (AC peak/DC)	V_{DD}	-	-	320	V
Operating LED forward current	I_F	5	7.5	25	mA
Continuous load current (AC peak/DC)	I_o	-	-	120	mA
Ambient operating temperature	T_a	-20	-	65	°C

Engineering Data

LED forward current vs. Ambient temperature

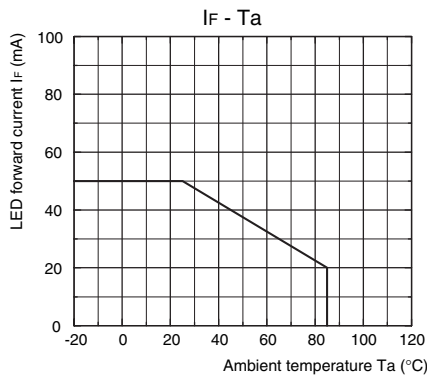

Continuous load current vs. Ambient temperature

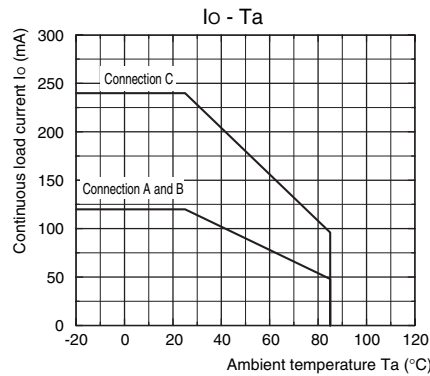

LED forward current vs. LED forward voltage

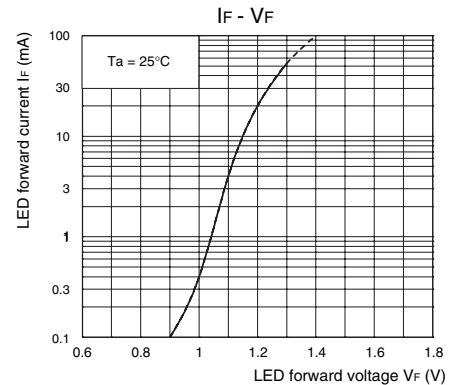

Continuous load current vs. On-state voltage

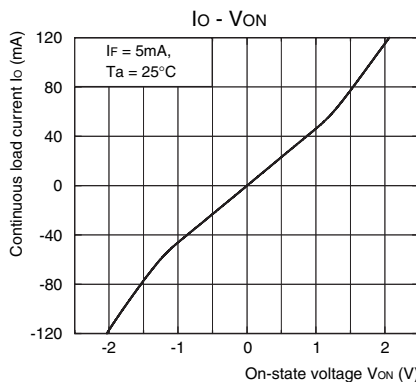

On-state resistance vs. Ambient temperature

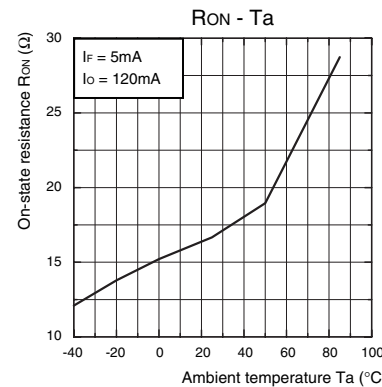

Trigger LED forward current vs. Ambient temperature

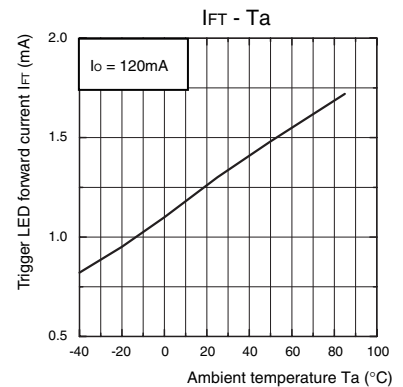

Turn ON, Turn OFF time vs. LED forward current

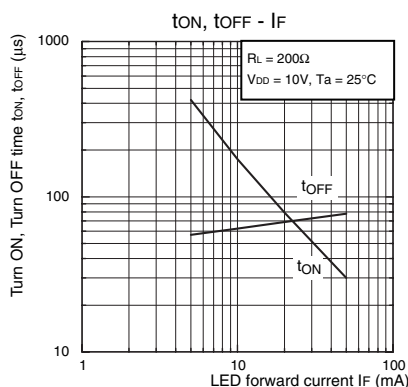

Turn ON, Turn OFF time vs. Ambient temperature

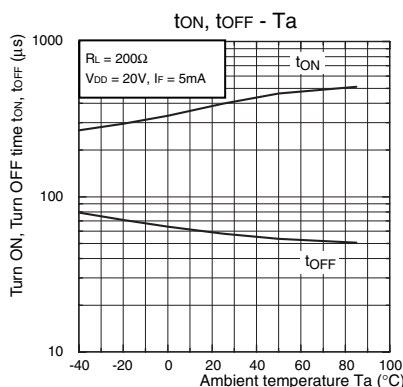

Current leakage vs. Ambient temperature

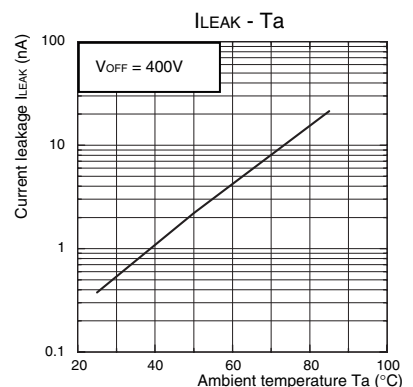

Safety Precautions

- Refer to "Common Precautions" for all G3VM models.

■ Appearance

DIP (Dual Inline Package)

DIP6

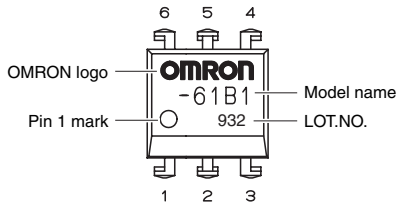

Note: The actual product is marked differently from the image shown here.

■ Dimensions

(Unit:mm)

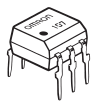

PCB Terminals

Weight: 0.4 g

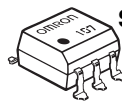
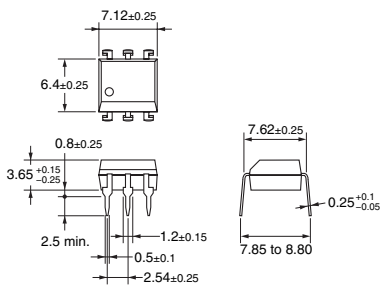

Surface-mounting Terminals

Weight: 0.4 g

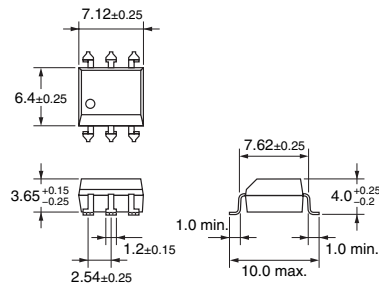

PCB Dimensions (BOTTOM VIEW)

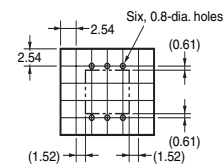

Actual Mounting Pad Dimensions

(Recommended Value, TOP VIEW)

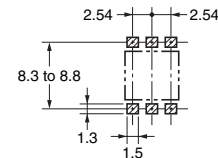

Note: The actual product is marked differently from the image shown here.

- Application examples provided in this document are for reference only. In actual applications, confirm equipment functions and safety before using the product.
- Consult your OMRON representative before using the product under conditions which are not described in the manual or applying the product to nuclear control systems, railroad systems, aviation systems, vehicles, combustion systems, medical equipment, amusement machines, safety equipment, and other systems or equipment that may have a serious influence on lives and property if used improperly. Make sure that the ratings and performance characteristics of the product provide a margin of safety for the system or equipment, and be sure to provide the system or equipment with double safety mechanisms.

Note: Do not use this document to operate the Unit.

OMRON Corporation

ELECTRONIC AND MECHANICAL COMPONENTS COMPANY

Contact: www.omron.com/ecb

Cat. No. **K220-E1-01**
0412(0412)(O)