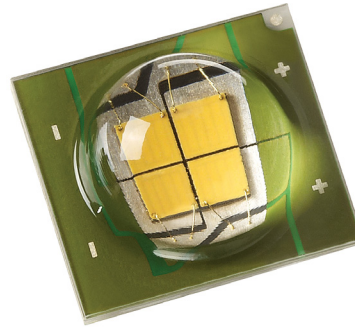

**SSM-80 LEDs**  

**Table of Contents**

Technology Overview .....2

Test Specifications .....2

White Binning Structure ....3

Chromaticity Bins .....4

Product Shipping & Labeling Information.....6

Electrical Characteristics ...7

Spectral Characteristics....8

Radiation Patterns .....8

Thermal Resistance .....9

Mechanical Dimensions .. 10

Solder Profile ..... 12

Tape & Reel Drawing ..... 13

Ordering Information .... 14

**Features:**

---

- 3000K Efficacy over 100 lm/W, Flux over 1,600 lumens
- High density small form-factor light source ideal for spot and directional applications
- ANSI compatible flux binning
- Low thermal resistance: 1.0 °C/W
- Lumen maintenance of greater than 70% after 60,000 hours
- RoHS compliant
- High reliability
- Electrically isolated thermal path
- 13V typical input voltage
- Narrow beam focus, MR-16 form factor

**Applications**

---

- Indoor Lighting
- Directional spot
- MR-16 light engine
- Track Lighting
- High-Output Area Lighting

## Technology Overview

Luminus Big Chip LEDs™ benefit from a suite of innovations in the fields of chip technology, packaging and thermal management. These breakthroughs allow illumination engineers and designers to achieve solutions that are high brightness and high efficiency.

### Photonic Lattice Technology

Luminus' photonic lattice technology enables large area LED chips with uniform brightness over the entire LED chip surface. The optical power and brightness produced by these large monolithic chips enable solutions which replace arc and halogen lamps where arrays of traditional high power LEDs cannot.

For red, green and blue LEDs, the photonic lattice structures extract more light and create radiation patterns that are more collimated than traditional LEDs. Having higher collimation from the source increases optical collection efficiencies and simplifies optical designs.

### Packaging Technology

Thermal management is critical in high power LED applications. With a thermal resistance from junction to case of 1.0° C/W. Luminus SSM-80 package is designed with high quality materials to provide customers with industry leading package thermal conductivity. This allows the LED to be driven at higher current densities while maintaining a low junction

temperature, thereby resulting in brighter solutions and longer lifetimes. The package is easy to use, and ready to be mounted in the lighting system.

### Reliability

Designed from the ground up, Luminus Big Chip LEDs are one of the most reliable light sources in the world today. Big Chip LEDs have passed a rigorous suite of environmental and mechanical stress tests, including mechanical shock, vibration, temperature cycling and humidity, and have been fully qualified for use in extreme high power and high current applications. With very low failure rates and median lifetimes that typically exceed 60,000 hours, Luminus Big Chip LEDs are ready for even the most demanding applications.

### Environmental Benefits

Luminus LEDs help reduce power consumption and the amount of hazardous waste entering the environment. All Big Chip LED products manufactured by Luminus are RoHS compliant and free of hazardous materials, including lead and mercury.

## Understanding Big Chip LED Test Specifications

Every Luminus LED is fully tested to ensure that it meets the high quality standards expected from Luminus' products.

### Testing Temperature

Luminus core board products are typically measured in such a way that the characteristics reported agree with how the devices will actually perform when incorporated into a system. This measurement is accomplished by mounting the devices on a 40°C heat sink and allowing the device to reach thermal equilibrium while fully powered. Only after the device reaches equilibrium are the measurements taken. This method of measurement ensures that Luminus Big Chip LEDs perform in the field just as they are specified.

Luminus surface mount LEDs are typically tested with a 20mSec input pulse and a junction temperature of 25°C. Expected flux values in real world operation can be extrapolated based on the information contained within this product data sheet.

### Multiple Operating Points (0.7A, 1.4A, 2.0 A)

The tables on the following pages provide typical optical and electrical characteristics. Since the LEDs can be operated over a wide range of drive conditions (currents from less than 350mA to 2.0 A, and duty cycle from <1% to 100%), multiple drive conditions are listed.

SSM-80 LEDs are production tested at 1.4 A. The values shown at 0.7A and 2.0A are for additional reference at other possible drive conditions.

## SSM-80 White Binning Structure

SSM-80 LEDs are tested for luminous flux and chromaticity at a drive current of 1.4 A and placed into one of the following luminous flux (FF) and chromaticity (WW) bins:

### Flux Bins

Flux Bin (FF)	Minimum Flux (lm) @ 1.4A	Maximum Flux (lm) @ 1.4A
JB	970	1,040
KA	1,040	1,120
KB	1,120	1,200
LA	1,200	1,290
LB	1,290	1,380

\*Note: Luminus maintains a +/- 6% tolerance on flux measurements.

### Chromaticity Bins

Luminus' Standard Chromaticity Bins: 1931 CIE Curve

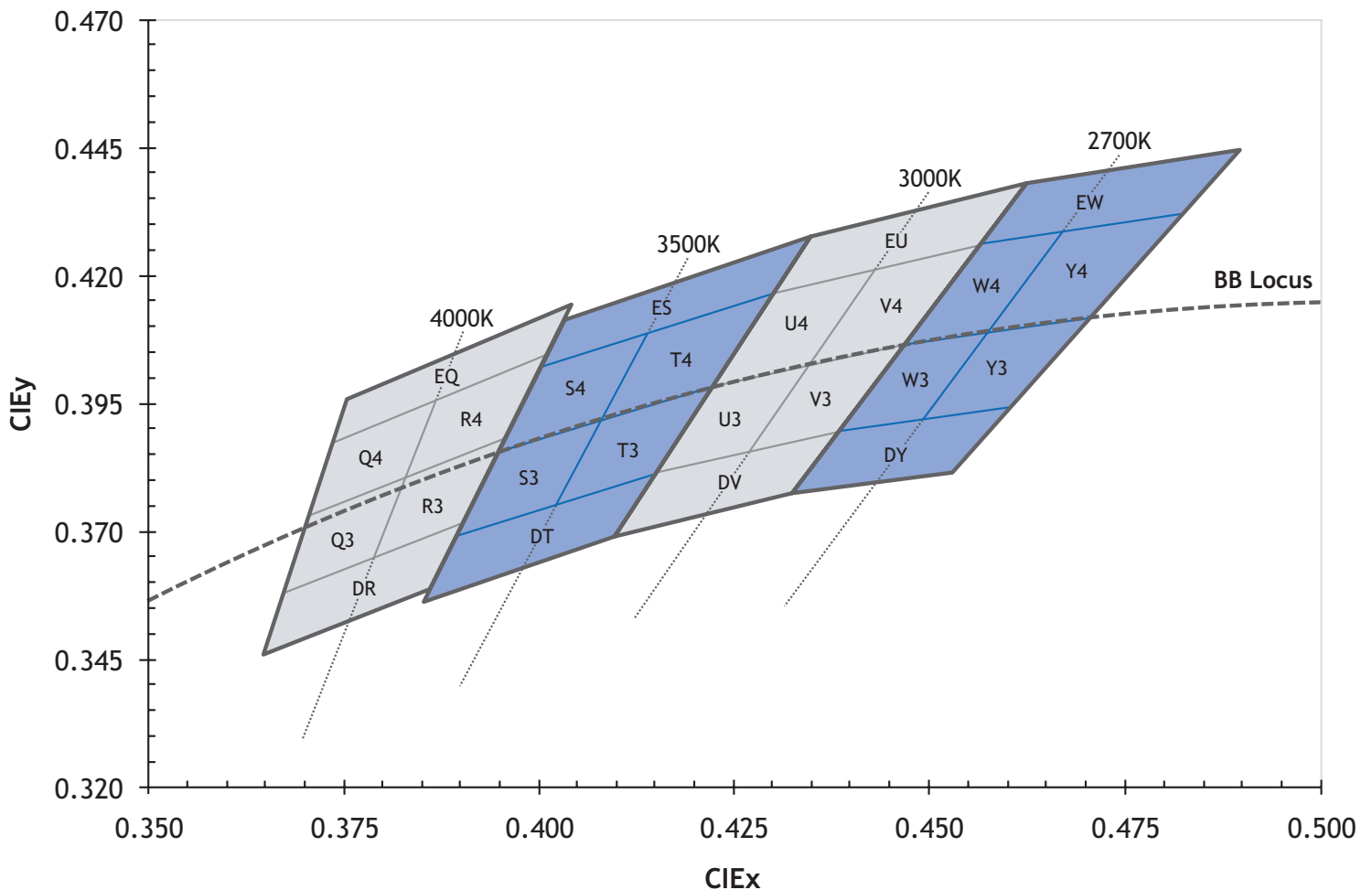

The following tables describe the four chromaticity points that bound each chromaticity bin. Chromaticity bins are grouped together based on the color temperature.

4000K Chromaticity Bins		
Bin Code (WW)	CIEx	CIey
EQ	0.376	0.396
	0.404	0.414
	0.401	0.404
	0.374	0.387
Q3*	0.370	0.373
	0.382	0.380
	0.378	0.365
	0.367	0.358
Q4*	0.374	0.387
	0.387	0.396
	0.382	0.380
	0.370	0.373
R3*	0.382	0.380
	0.395	0.388
	0.390	0.372
	0.378	0.365
R4*	0.387	0.396
	0.401	0.404
	0.395	0.388
	0.382	0.380
DR	0.367	0.358
	0.390	0.372
	0.386	0.359
	0.364	0.346

3500K Chromaticity Bins		
Bin Code (WW)	CIEx	CIey
ES	0.403	0.411
	0.435	0.427
	0.430	0.417
	0.400	0.402
S3*	0.394	0.385
	0.407	0.392
	0.402	0.375
	0.389	0.369
S4*	0.400	0.402
	0.415	0.409
	0.407	0.392
	0.394	0.385
T3*	0.407	0.392
	0.422	0.399
	0.415	0.381
	0.402	0.375
T4*	0.415	0.409
	0.430	0.417
	0.422	0.399
	0.407	0.392
DT	0.389	0.369
	0.415	0.381
	0.409	0.369
	0.385	0.357

3000K Chromaticity Bins		
Bin Code (WW)	CIE <sub>x</sub>	CIE <sub>y</sub>
EU	0.435	0.427
	0.462	0.437
	0.456	0.426
	0.430	0.417
U3*	0.422	0.399
	0.434	0.403
	0.426	0.385
	0.415	0.381
U4*	0.430	0.417
	0.443	0.421
	0.434	0.403
	0.422	0.399
V3*	0.434	0.403
	0.447	0.408
	0.437	0.389
	0.426	0.385
V4*	0.443	0.421
	0.456	0.426
	0.447	0.408
	0.434	0.403
DV	0.415	0.381
	0.437	0.389
	0.431	0.377
	0.409	0.369

2700K Chromaticity Bins		
Bin Code (WW)	CIE <sub>x</sub>	CIE <sub>y</sub>
EW	0.462	0.437
	0.488	0.444
	0.481	0.432
	0.456	0.426
W3*	0.447	0.408
	0.458	0.410
	0.448	0.392
	0.437	0.389
W4*	0.456	0.426
	0.469	0.429
	0.458	0.410
	0.447	0.408
Y3*	0.458	0.410
	0.70	0.413
	0.459	0.394
	0.448	0.392
Y4*	0.469	0.429
	0.481	0.432
	0.470	0.413
	0.458	0.410
DY	0.437	0.389
	0.459	0.394
	0.452	0.382
	0.431	0.377

\*Sub-bins within ANSI defined quadrangles per ANSI C78.377-2008

## Product Shipping & Labeling Information

All SSM-80 products are packaged and labeled with their respective bin as outlined in the tables from pages 3 to 5. When shipped, each package will only contain one bin. The part number designation is as follows:

SSM — 80 — WNNX — A91 — FF — WW

Product Family	Chip Area	Color	Package Configuration	Flux Bin	Chromaticity Bin
Surface Mount (Overmolded)	8.0 mm <sup>2</sup>	CCT & CRI See Note 1 below	Internal Code	See page 3 for bins	See page 4-5 for bins

Note 1: WNNX nomenclature corresponds to the following:

W = White

NN = color temperature, where:

40 corresponds to 4000K

35 corresponds to 3500K

30 corresponds to 3000K

27 corresponds to 2700K

X = color rendering index, where:

M (moderate) corresponds to a typical CRI of 83

Note 2: Some flux and chromaticity bins may have limited availability. Application specific bin kits, consisting of multiple bins, may be available. For ordering information, please refer to page 12 and reference PDS-001791: SSM-80 Binning & Labeling document.

### Example:

The part number SSM-80-W30M-A91-LA-U3 refers to a 3000K color temperature, 83 typical CRI, white, SSM-80 emitter, with a flux range of 1,200 to 1,290 lumens and a chromaticity value within the box defined by the four points (0.422, 0.399), (0.434, 0.403), (0.426, 0.386), (0.415, 0.381).

## Electrical Characteristics<sup>1</sup>

### Optical and Electrical Characteristics (T<sub>j</sub> = 25 °C)

Drive Condition <sup>2</sup>		0.7 A	1.4 A	2.0 A	
Parameter	Symbol	Typical Values at Indicated Current <sup>3</sup>	Values at Test Currents	Typical Values at Indicated Current <sup>3</sup>	Unit
Current Density	j	0.35	0.7	1.0	A/mm <sup>2</sup>
Forward Voltage	V <sub>F, min</sub>		11.95		V
	V <sub>F, typ</sub>	12.3	13.0	13.6	V
	V <sub>F, max</sub>		14.6		V

### Common Characteristics

Parameter	Symbol	Values	Unit
Viewing Angle	2 θ <sub>1/2</sub>	120	degrees
Emitting Area		1.9	mm <sup>2</sup>
Emitting Area Dimensions		1.38 x 1.38 x 4	mm×mm
Forward Voltage Temperature Coefficient <sup>4</sup>		-8.4	mV/°C

### Absolute Maximum Ratings

Parameter	Symbol	Values	Unit
Maximum Current <sup>5</sup>		2.0	A
Maximum Reverse Current		N/A	A
Maximum Junction Temperature <sup>6</sup>	T <sub>j-max</sub>	150	°C
Storage Temperature Range		-40/+100	°C

Note 1: Listed drive conditions are typical for common applications. SSM-80 devices can be driven at currents ranging from <350A to 2A and at duty cycles ranging from <1% to 100%. Drive current and duty cycle should be adjusted as necessary to maintain the junction temperature desired to meet application lifetime requirements.

Note 2: Unless otherwise noted, values listed are typical.

Note 3: Forward voltage temperature coefficient at 3.15A. Contact Luminus for value at other drive conditions.

Note 4: SSM-80 devices are designed for operation to an absolute maximum forward drive current 2A. Product lifetime data is specified at recommended forward drive currents. Sustained operation at absolute maximum currents will result in a reduction of device lifetime compared to recommended forward drive currents. Actual device lifetimes will also depend on junction temperature. In pulsed operation, rise time from 10-90% of forward current should be larger than 0.5 microseconds.

Note 5: Lifetime dependent on LED junction temperature. Thermal calculations based on input power and thermal management system should be performed to ensure T<sub>j</sub> is maintained below T<sub>j-max</sub> rating or life will be reduced.

Note 6: CIE measurement uncertainty for white devices is estimated to be +/- 0.01.

Note 7: Special design considerations must be observed for operation under 1A. Please contact Luminus for further information.

Note 8: Caution must be taken not to stare at the light emitted from these LEDs. Under special circumstances, the high intensity could damage the eye.

### Relative Output Flux vs. Forward Current<sup>1</sup>

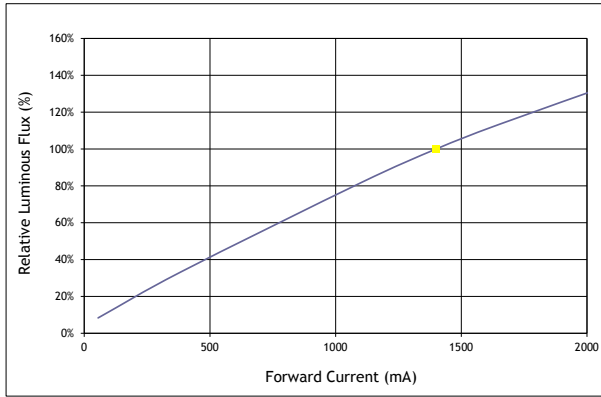

### Forward Current vs. Forward Voltage

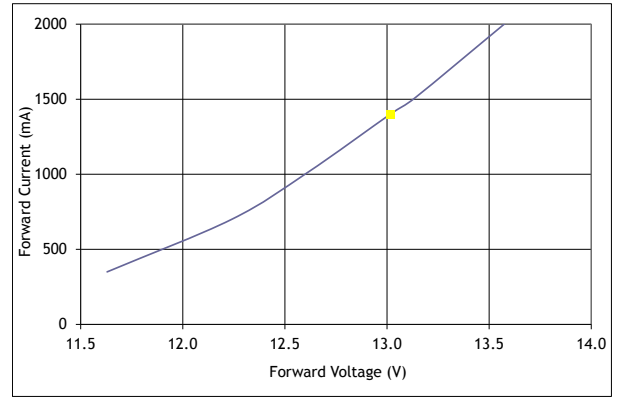

### Typical Spectrum<sup>4</sup>

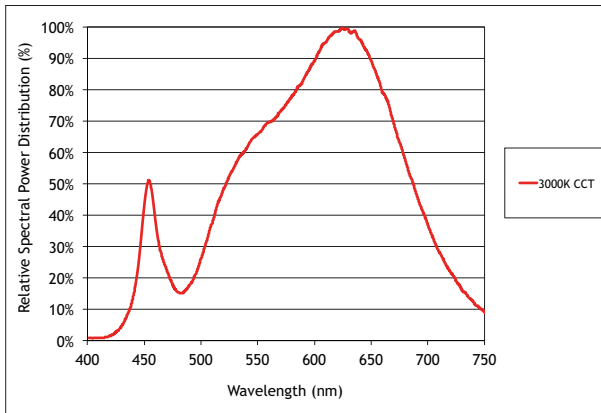

### Relative Flux vs. Junction Temperature

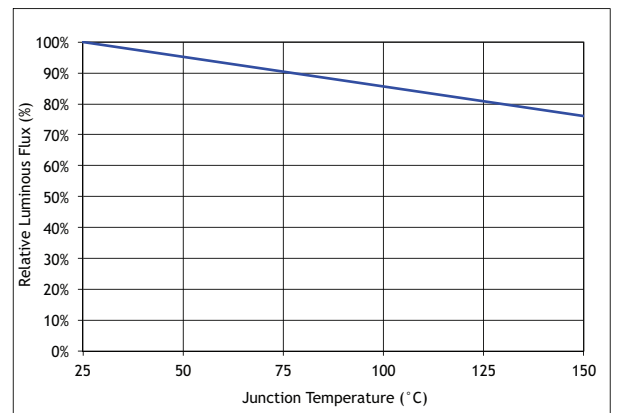

### Typical Angular Radiation Pattern

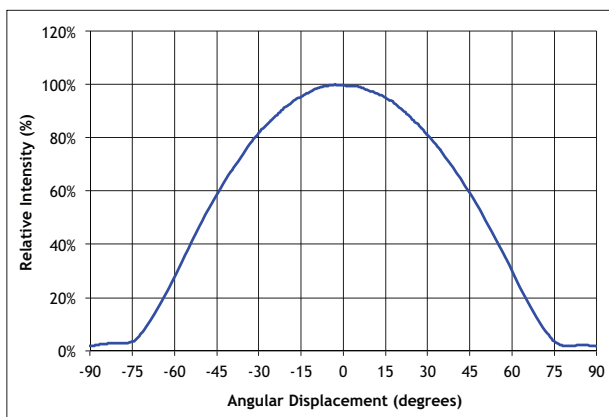

### Change in Chromaticity

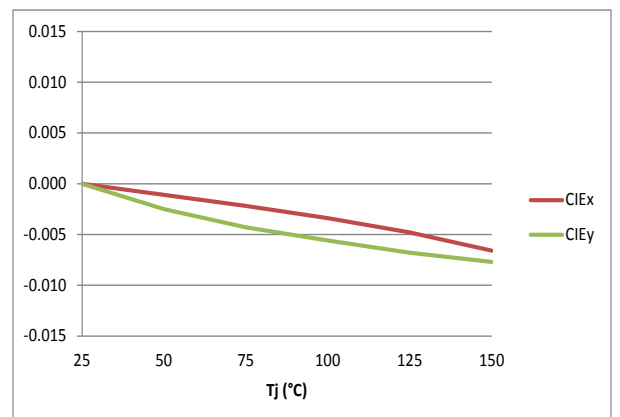

Note 1: Yellow squares indicate typical operating conditions.

Note 2: Mean expected lifetime in dependence of junction temperature at 0.35 A/mm<sup>2</sup> in continuous operation. Lifetime defined as time to 70% of initial intensity. Based on lifetime test data of uncoated GaN devices at this time. Data can be used to model failure rate over typical product lifetime (contact Luminus for lifetime reliability test data for 1A/mm<sup>2</sup> condition).

Note 3: Lumen maintenance in dependence of time at 0.35 A/mm<sup>2</sup> in continuous operation with junction temperatures of 100 °C.

Note 4: Typical spectrum at current density of 0.35 A/mm<sup>2</sup> in continuous operation.



### Thermal Resistance

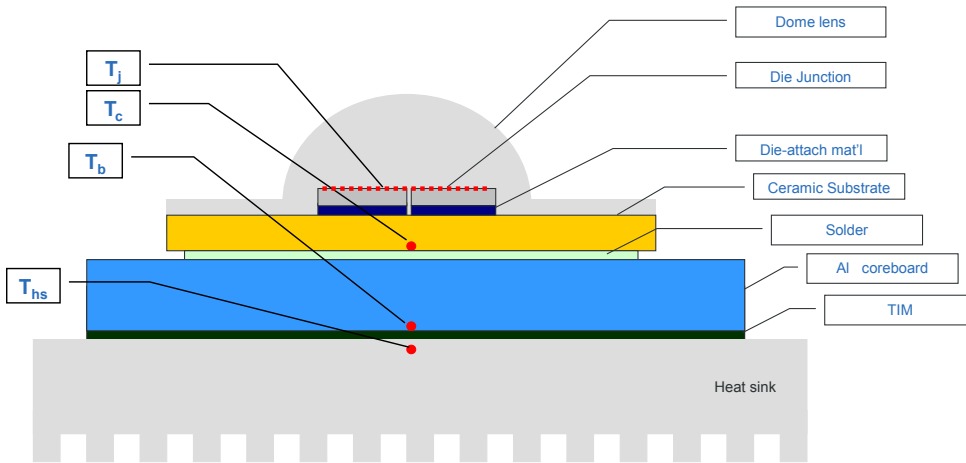

#### Typical Thermal Resistance, junction to case

$R_{j-c}^1$	0.4 °C/W
$R_{j-b}^1$	1.3 °C/W
$R_{j-hs}^2$	1.5 °C/W

Note 1: Thermal resistance values are based on FEA model results correlated to measured  $R_{\theta j-hs}$  data.

Note 2: Thermal resistance is measured using a SAC305 solder, a Bergquist Al-clad MCPCB, and eGraf 1205 thermal interface material.

**Mechanical Dimensions – SSM-80 Emitter**

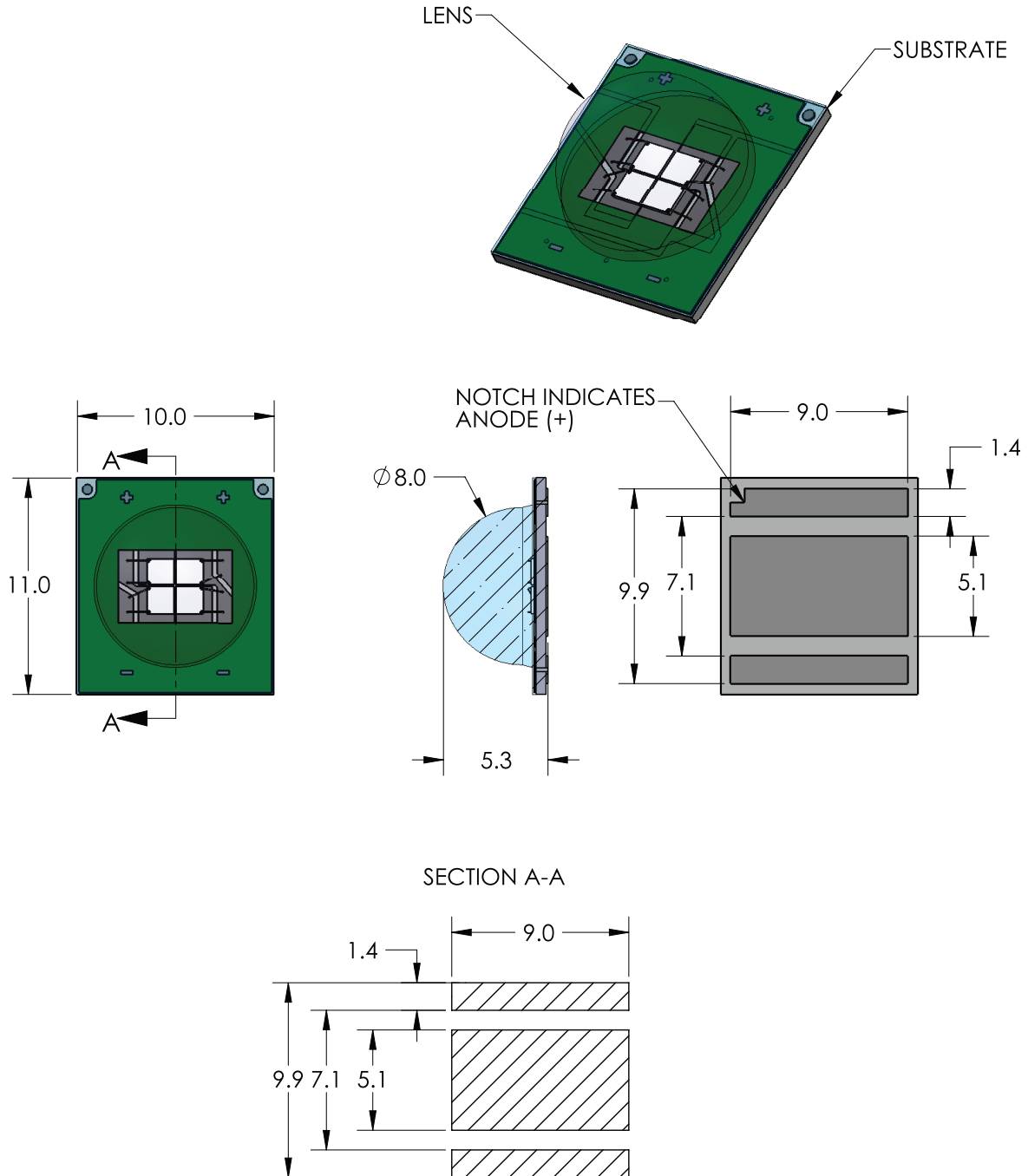

For detailed drawing please refer to DWG-001359 document.

**Mechanical Dimensions – SSM-80 Star Board**

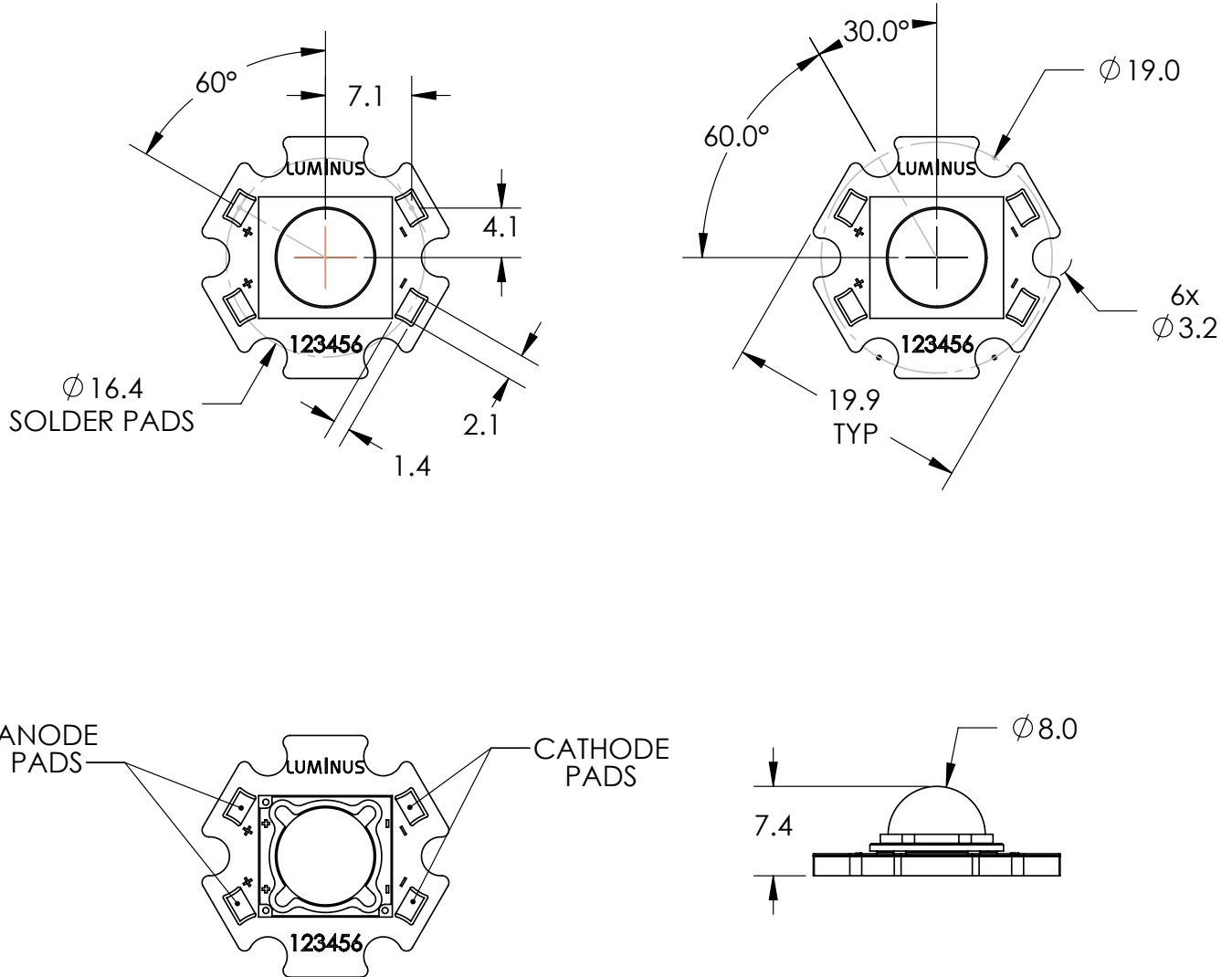

Note 1: Recommended mounting screw: M3 or #4.

Note 2: All dimensions in millimeters.

Note 3: All anode pads on board are interconnected. All cathode pads on board are interconnected.



## Solder Profile

SAC 305 Reflow Profile Window For Low Density Boards

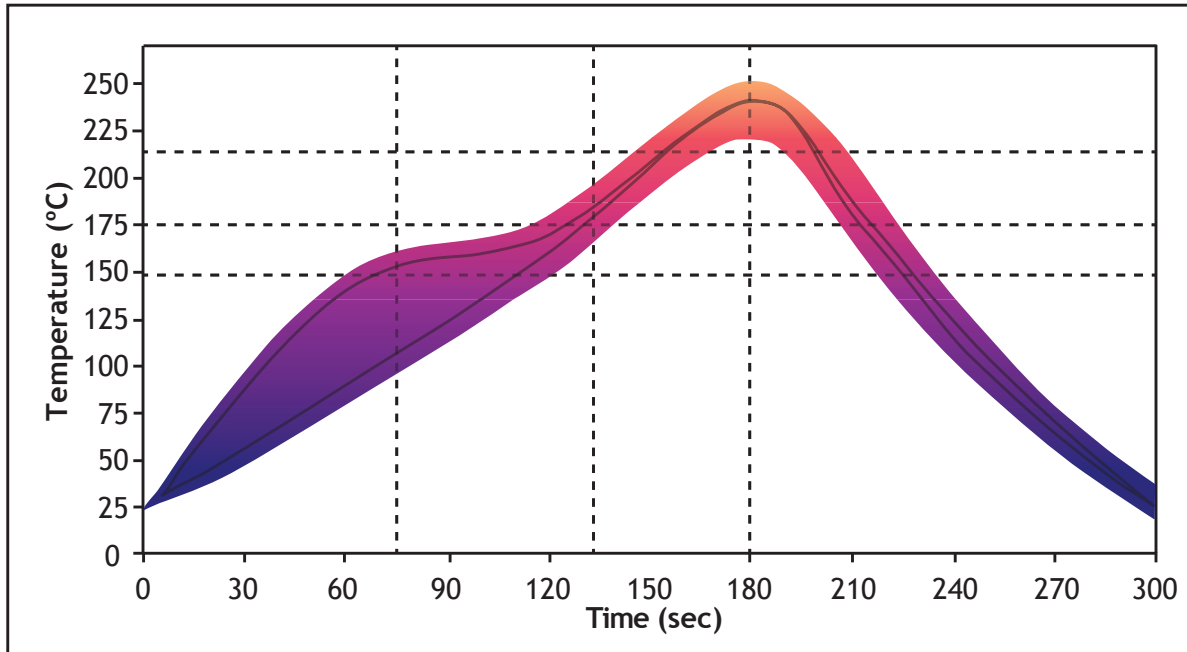

Lead free solder guideline for low density boards

Solder Profile Stage	Lead-Free Solder	Lead-based Solder
Profile length, Ambient to Peak	2.75 - 3.5 minutes	2.75 - 3.5 minutes
Time Maintained Above: Temperature	217 °C	183 °C
Time Maintained Above: Time	30 - 60 seconds	30 - 60 seconds
Cooldown Rate	≤4° C/sec	≤4° C/sec
Cooldown Duration	45 ± 15 sec	45 ± 15 sec

Note 1: Temperatures are taken and monitored at the component copper layer.

Note 2: Optimum profile may differ due to oven type, circuit board or assembly layout.

Note 3: Recommended lead free, no-clean solder: AIM NC254-SAC305.

Note 4: Refer to APN-001473 soldering and handling application note for additional solder profiles and details.

### Tape and Reel Drawing

DIMENSIONS ARE IN mm. (INCH)

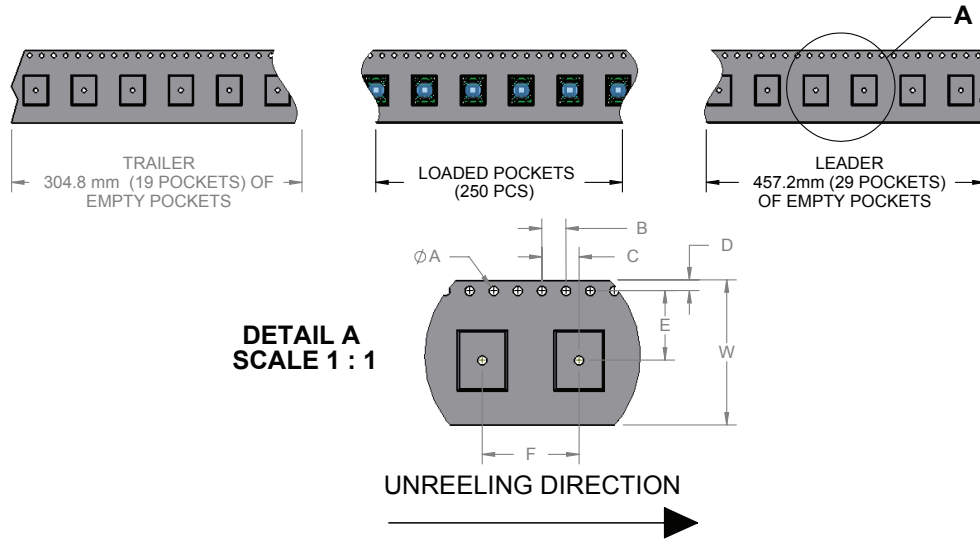

TAPE DIMENSIONS						
W	∅A	B	C	D	E	F
24.0 (.945)	1.5 (.059)	3.9 (.157)	6.1 (.241)	1.7 (.069)	11.5 (.453)	16.0 (.630)

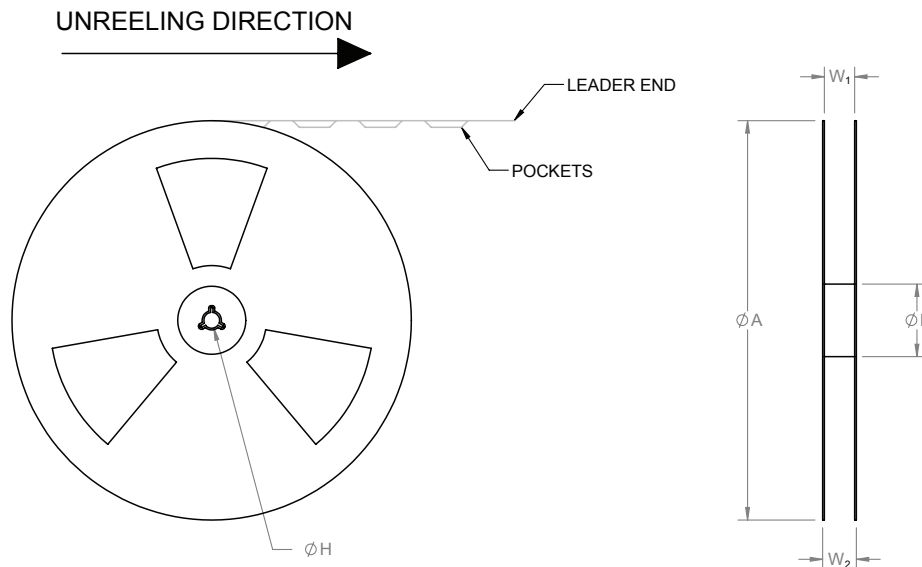

REEL DIMENSIONS				
∅A	W <sub>1</sub>	W <sub>2</sub>	∅B	∅H
∅330.2 (13.0)	25 (.984)	27.8 (1.094)	60.0 (2.362)	∅13.0 (.512)

**Ordering Information**

Ordering Part Number <sup>1,2</sup>	Color	Description
SSM-80-W40M-A91-LB500	4000K White	White Big Chip LED™ SSM-80 surface mount device consisting of four 2.0 mm <sup>2</sup> LEDs mounted on a ceramic substrate, tray pack
SSM-80-W35M-A91-LA600	3500K White	
SSM-80-W30M-A91-KB700	3000K White	
SSM-80-W27M-A91-KA800	2700K White	
SSR-80-W40M-R91-LB500	4000K White	SSR-80 evaluation module consisting of a SSM-80 surface mount device mounted on an aluminum star board.
SSR-80-W35M-R91-LA600	3500K White	
SSR-80-W30M-R91-KB700	3000K White	
SSR-80-W27M-R91-KA800	2700K White	

Note 1: MA500 - denotes a bin kit comprising of all flux bins with minimum flux of 1,380 and chromaticity bins at the 4000K color points

Note 2: For ordering information on all available bin kits, please see PDS-001791: SSM-80 Binning & Labeling document.

The products, their specifications and other information appearing in this document are subject to change by Luminus Devices without notice. Luminus Devices assumes no liability for errors that may appear in this document, and no liability otherwise arising from the application or use of the product or information contained herein. None of the information provided herein should be considered to be a representation of the fitness or suitability of the product for any particular application or as any other form of warranty. Luminus Devices' product warranties are limited to only such warranties as accompany a purchase contract or purchase order for such products. Nothing herein is to be construed as constituting an additional warranty. No information contained in this publication may be considered as a waiver by Luminus Devices of any intellectual property rights that Luminus Devices may have in such information. Big Chip LEDs™ is a registered trademark of Luminus Devices, Inc., all rights reserved.

This product is protected by U.S. Patents 6,831,302; 7,074,631; 7,083,993; 7,084,434; 7,098,589; 7,105,861; 7,138,666; 7,166,870; 7,166,871; 7,170,100; 7,196,354; 7,211,831; 7,262,550; 7,274,043; 7,301,271; 7,341,880; 7,344,903; 7,345,416; 7,348,603; 7,388,233; 7,391,059 Patents Pending in the U.S. and other countries.