

74F14 Hex Inverter Schmitt Trigger

General Description

The 74F14 contains six logic inverters which accept standard TTL input signals and provide standard TTL output levels. They are capable of transforming slowly changing input signals into sharply defined, jitter-free output signals. In addition, they have a greater noise margin than conventional inverters.

Each circuit contains a Schmitt trigger followed by a Darlington level shifter and a phase splitter driving a TTL

totem-pole output. The Schmitt trigger uses positive feedback to effectively speed-up slow input transition, and provide different input threshold voltages for positive and negative-going transitions. This hysteresis between the positive-going and negative-going input thresholds (typically 800 mV) is determined internally by resistor ratios and is essentially insensitive to temperature and supply voltage variations.

Ordering Code:

| Order Number | Package Number | Package Description |
|--------------|----------------|--|
| 74F14SC | M14A | 14-Lead Small Outline Integrated Circuit (SOIC), JEDEC MS-012, 0.150" Narrow |
| 74F14SJ | M14D | Pb-Free 14-Lead Small Outline Package (SOP), EIAJ TYPE II, 5.3mm Wide |
| 74F14PC | N14A | 14-Lead Plastic Dual-In-Line Package (PDIP), JEDEC MS-001, 0.300" Wide |

Devices also available in Tape and Reel. Specify by appending the suffix letter "X" to the ordering code.

Logic Symbol

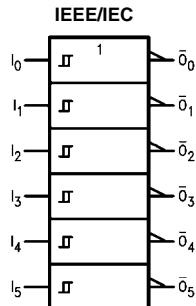

Connection Diagram

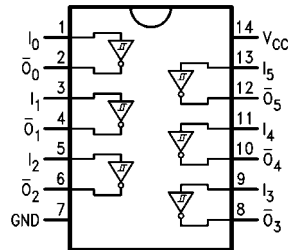

Unit Loading/Fan Out

| Pin Names | Description | U.L. | |
|-------------|-------------|----------|---|
| | | HIGH/LOW | Input I_{IH}/I_{IL} Output I_{OH}/I_{OL} |
| I_n | Input | 1.0/1.0 | 20 μ A/-0.6 mA |
| \bar{O}_n | Output | 50/33.3 | -1 mA/20 mA |

Function Table

| Input | Output |
|-------|-----------|
| A | \bar{O} |
| L | H |
| H | L |

H = HIGH Voltage Level
L = LOW Voltage Level

Absolute Maximum Ratings (Note 1)

| | |
|--|--------------------------------------|
| Storage Temperature | -65°C to +150°C |
| Ambient Temperature under Bias | -55°C to +125°C |
| Junction Temperature under Bias | -55°C to +175°C |
| V _{CC} Pin Potential to Ground Pin | -0.5V to +7.0V |
| Input Voltage (Note 2) | -0.5V to +7.0V |
| Input Current (Note 2) | -30 mA to +5.0 mA |
| Voltage Applied to Output in HIGH State (with V _{CC} = 0V) | |
| Standard Output | -0.5V to V _{CC} |
| 3-STATE Output | -0.5V to +5.5V |
| Current Applied to Output in LOW State (Max) | twice the rated I _{OL} (mA) |
| ESD Last Passing Voltage (Min) | 4000V |

Recommended Operating Conditions

| | |
|------------------------------|----------------|
| Free Air Ambient Temperature | 0°C to +70°C |
| Supply Voltage | +4.5V to +5.5V |

Note 1: Absolute maximum ratings are values beyond which the device may be damaged or have its useful life impaired. Functional operation under these conditions is not implied.

Note 2: Either voltage limit or current limit is sufficient to protect inputs.

DC Electrical Characteristics

| Symbol | Parameter | Min | Typ | Max | Units | V _{CC} | Conditions |
|------------------|--|---|------------|------|-------|-----------------|--|
| V _{T+} | Positive-Going Threshold | 1.5 | 1.7 | 2.0 | V | 5.0V | |
| V _{T-} | Negative-Going Threshold | 0.7 | 0.9 | 1.1 | V | 5.0V | |
| ΔV _T | Hysteresis (V _{T+} -V _{T-}) | 0.4 | 0.8 | | V | 5.0V | |
| V _{CD} | Input Clamp Diode Voltage | | | -1.2 | V | Min | I _{IN} = -18 mA |
| V _{OH} | Output HIGH Voltage | 10% V _{CC} 5% V _{CC} | 2.5 2.7 | | V | Min | I _{OH} = -1 mA I _{OH} = -1 mA |
| V _{OL} | Output LOW Voltage | 10% V _{CC} | | 0.5 | V | Min | I _{OL} = 20 mA |
| I _{HI} | Input HIGH Current | | | 5.0 | μA | Max | V _{IN} = 2.7V |
| I _{BVI} | Input HIGH Current Breakdown Test | | | 7.0 | μA | Max | V _{IN} = 7.0V |
| I _{CEX} | Output HIGH Leakage Current | | | 50 | μA | Max | V _{OUT} = V _{CC} |
| V _{ID} | Input Leakage Test | 4.75 | | | V | Max | I _{ID} = 1.9 μA All Other Pins Grounded |
| I _{OD} | Output Leakage Circuit Current | | | 3.75 | μA | 0.0 | V _{IOD} = 150 mV All Other Pins Grounded |
| I _{IL} | Input LOW Current | | | -0.6 | mA | Max | V _{IN} = 0.5V |
| I _{OS} | Output Short-Circuit Current | -60 | | -150 | mA | Max | V _{OUT} = 0V |
| I _{CCH} | Power Supply Current | | | 25 | mA | Max | V _O = HIGH |
| I _{CCL} | Power Supply Current | | | 25 | mA | Max | V _O = LOW |

AC Electrical Characteristics

| Symbol | Parameter | T _A = +25°C V _{CC} = +5.0V C _L = 50 pF | | T _A = -55°C to +125°C V _{CC} = +5.0V C _L = 50 pF | | T _A = 0°C to +70°C V _{CC} = +5.0V C _L = 50 pF | | Units |
|------------------|---------------------------------|---|------|---|------|--|------|-------|
| | | Min | Max | Min | Max | Min | Max | |
| t _{PLH} | Propagation Delay | 4.0 | 10.5 | 4.0 | 13.0 | 4.0 | 11.5 | ns |
| t _{PHL} | I _n → 0 _n | 3.5 | 8.5 | 3.5 | 10.0 | 3.5 | 9.0 | |

Physical Dimensions inches (millimeters) unless otherwise noted

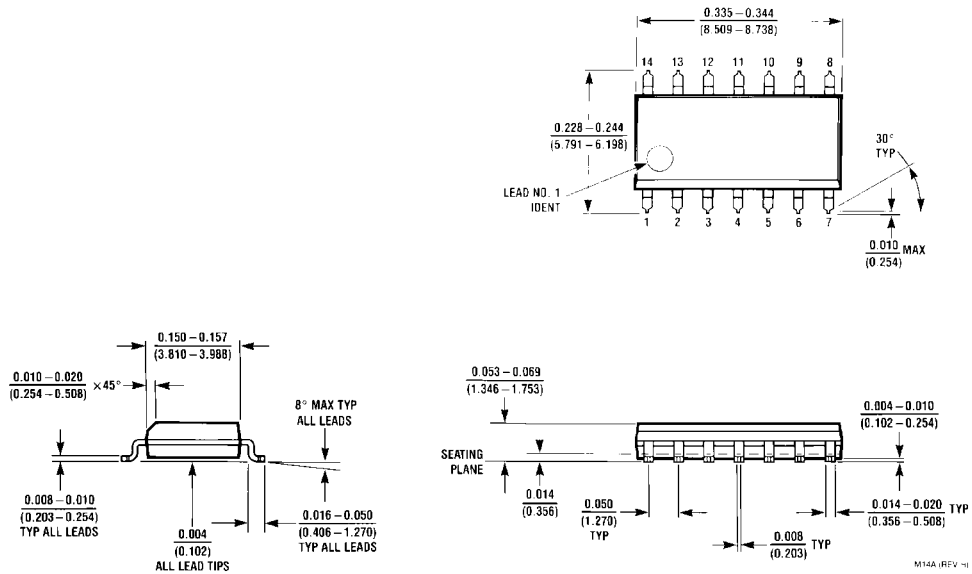

**14-Lead Small Outline Integrated Circuit (SOIC), JEDEC MS-012, 0.150" Narrow
Package Number M14A**

Physical Dimensions inches (millimeters) unless otherwise noted (Continued)

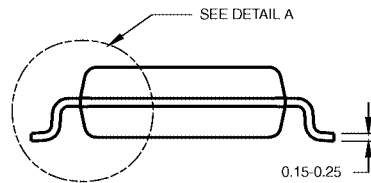
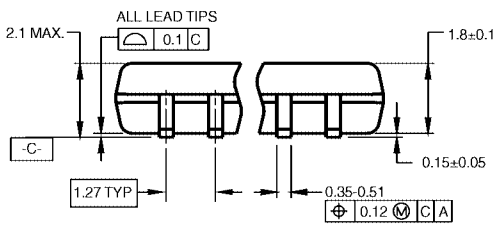
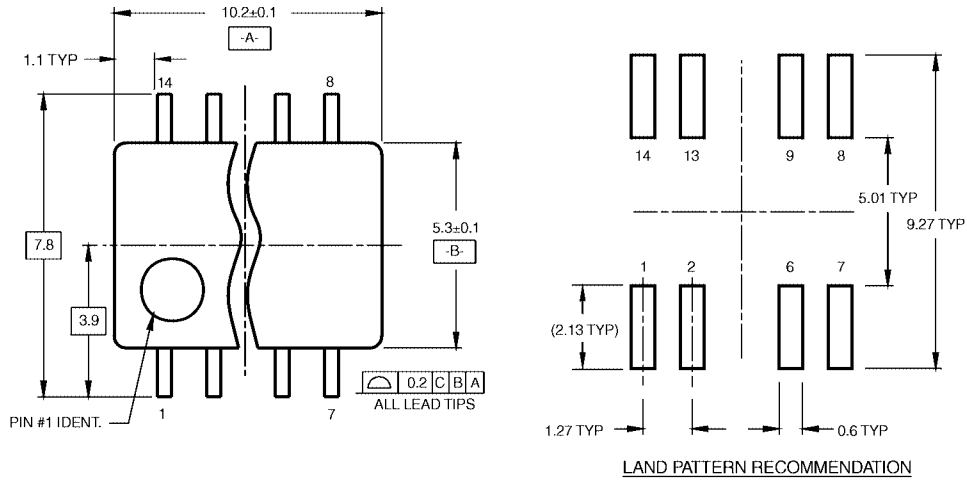

- NOTES:
 A. CONFORMS TO EIAJ EDR-7320 REGISTRATION, ESTABLISHED IN DECEMBER, 1998.
 B. DIMENSIONS ARE IN MILLIMETERS.
 C. DIMENSIONS ARE EXCLUSIVE OF BURRS, MOLD FLASH, AND TIE BAR EXTRUSIONS.

M14DRevB1

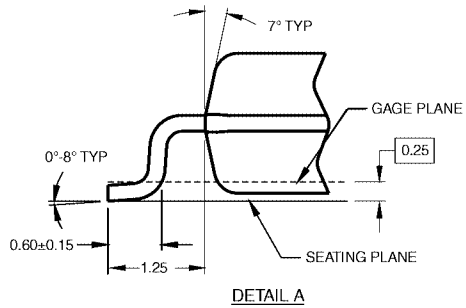

Pb-Free 14-Lead Small Outline Package (SOP), EIAJ TYPE II, 5.3mm Wide Package Number M14D

Physical Dimensions inches (millimeters) unless otherwise noted (Continued)

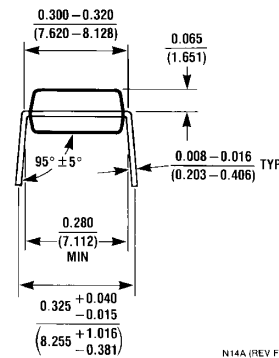
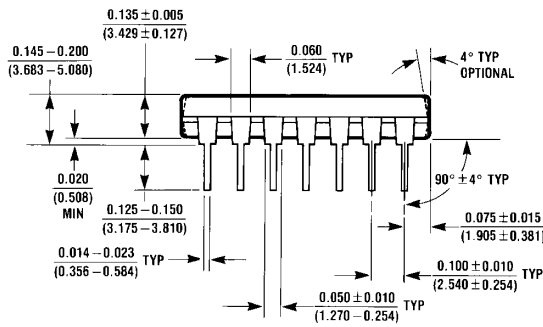
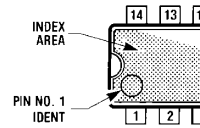
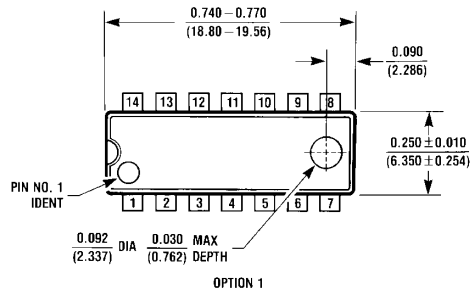

14-Lead Plastic Dual-In-Line Package (PDIP), JEDEC MS-001, 0.300" Wide Package Number N14A

N14A (REV F)

Fairchild does not assume any responsibility for use of any circuitry described, no circuit patent licenses are implied and Fairchild reserves the right at any time without notice to change said circuitry and specifications.

LIFE SUPPORT POLICY

FAIRCHILD'S PRODUCTS ARE NOT AUTHORIZED FOR USE AS CRITICAL COMPONENTS IN LIFE SUPPORT DEVICES OR SYSTEMS WITHOUT THE EXPRESS WRITTEN APPROVAL OF THE PRESIDENT OF FAIRCHILD SEMICONDUCTOR CORPORATION. As used herein:

1. Life support devices or systems are devices or systems which, (a) are intended for surgical implant into the body, or (b) support or sustain life, and (c) whose failure to perform when properly used in accordance with instructions for use provided in the labeling, can be reasonably expected to result in a significant injury to the user.
2. A critical component in any component of a life support device or system whose failure to perform can be reasonably expected to cause the failure of the life support device or system, or to affect its safety or effectiveness.

www.fairchildsemi.com