

DIN W75×H25mm Digital Graphic Panel Meter For Mosaic Panel

■ Features

- Various input function
: 0-2VDC, 0-10VDC, 1-5VDC,
DC0-1mA, DC4-20mA
- High/low-limit display scale function
- Max. display range: -999 to 9999
- Error display function
- High quality by microprocessor built-in
- Display accuracy: F.S. $\pm 0.2\%$ rdg ± 1 -digit



⚠ Please read "Safety Considerations" in the instruction manual before using.

■ Ordering Information

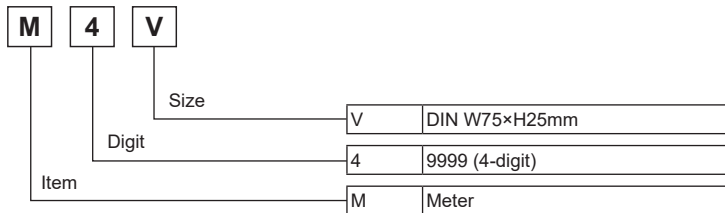

■ Specifications

| | | | | | |
|-------------------------|---|--|------------------|------------|----------|
| Model | M4V | | | | |
| Measurement function | DC voltage | | | DC current | |
| Measurement input | 0-2VDC \equiv | 1-5VDC \equiv | 0-10VDC \equiv | DC0-1mA | DC4-20mA |
| Max. allowable input | 110% of measurement input | | | | |
| Power supply | 12-24VDC \equiv | | | | |
| Allowable voltage range | 90 to 110% of rated voltage | | | | |
| Power consumption | Max. 2W | | | | |
| Display method | 7-segment LED display (red) (character height: 14mm) | | | | |
| Display accuracy | 0 to 50°C: F.S. $\pm 0.2\%$ rdg ± 1 -digit -10 to 0°C: F.S. $\pm 0.3\%$ rdg ± 1 -digit | | | | |
| Display cycle | 500ms | | | | |
| Setting type | Setting type with the front keys | | | | |
| Self-diagnosis function | Error display function | | | | |
| Insulation resistance | Over 100M Ω (at 500VDC megger) | | | | |
| Dielectric strength | 2,000VAC 50/60Hz for 1 min | | | | |
| Noise immunity | ± 300 V the square wave noise (pulse width: 1 μ s) by the noise simulator | | | | |
| Vibration | Mechanical | 0.75mm amplitude at frequency of 10 to 50Hz (for 1 min) in each X, Y, Z direction for 1 hour | | | |
| | Malfunction | 0.5mm amplitude at frequency of 10 to 50Hz (for 1 min) in each X, Y, Z direction for 10 min | | | |
| Shock | Mechanical | 300m/s ² (approx. 30G) in each X, Y, Z direction for 3 times | | | |
| | Malfunction | 100m/s ² (approx. 10G) in each X, Y, Z direction for 3 times | | | |
| Environ-ment | Ambient temperature | -10 to 50°C, storage: 20 to 60°C | | | |
| | Ambient humidity | 35 to 85%RH, storage: 35 to 85%RH | | | |
| Unit weight | Approx. 83g | | | | |

※Environment resistance is rated at no freezing or condensation.

SENSORS

CONTROLLERS

MOTION DEVICES

SOFTWARE

(J) Temperature Controllers

(K) SSRs

(L) Power Controllers

(M) Counters

(N) Timers

(O) Digital Panel Meters

(P) Indicators

(Q) Converters

(R) Digital Display Units

(S) Sensor Controllers

(T) Switching Mode Power Supplies

(U) Recorders

(V) HMIs

(W) Panel PC

(X) Field Network Devices

M4V

Dimensions

(unit: mm)

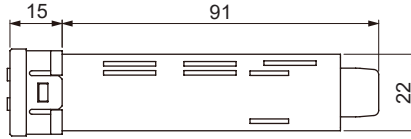
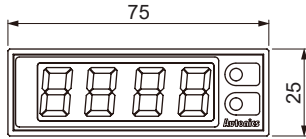

Bracket

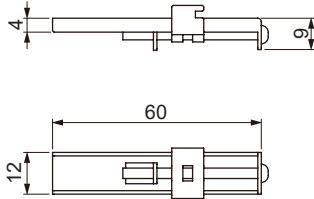

Panel cut-out

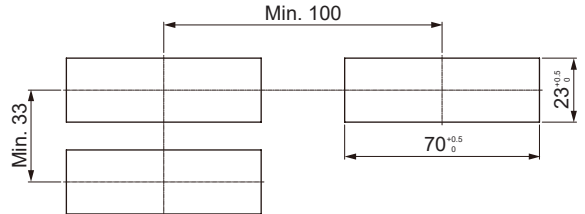

Input and Connection

| Input | Display | Connection |
|---------|----------|------------|
| Voltage | 0-2VDC | 0-2U |
| | 1-5VDC | 1-5U |
| | 0-10VDC | 0-10 |
| Current | DC0-1mA | 1mA |
| | DC4-20mA | 4-20 |

| Terminal | 1 | 2 | 3 | 4 | 5 | 6 |
|----------|----|---|---|-----|----------|----------|
| 0-2VDC | HI | | | LOW | SOURCE - | SOURCE + |
| 1-5VDC | | | | | | |
| 0-10VDC | | | | | | |
| DC0-1mA | | | | | | |
| DC4-20mA | | | | | | |

※Use terminals of size specified below.

| | a | b |
|--------------|------------|------------|
| <Forked> | Min. 3.5mm | Min. 7.0mm |

Connections of Applications

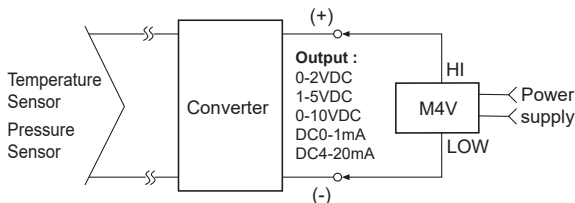

Simultaneous connection of voltmeter and ammeter

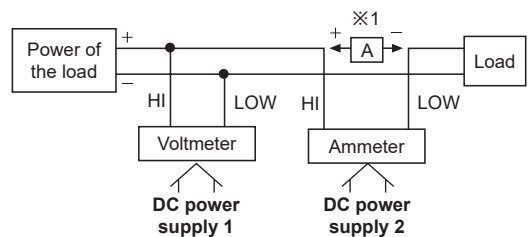

※1: Compared to measurement input range, higher measuring voltage needs a multiplier and lower measuring voltage needs a shunt.

※When using voltmeter and ammeter simultaneously, connect the separated power supply each.

※(-) terminal of the power and (-) terminal of measurement input are shorted.

Factory Defaults

| Parameter | Factory default | Parameter | Factory default | Parameter | Factory default |
|-----------|-----------------|-----------|-----------------|-----------|-----------------|
| Unit | 0-2U | HI | 0.0 | Unit | 0000 |
| LO | 0000 | dot | 0.0 | LO | OFF |

Parameter Description

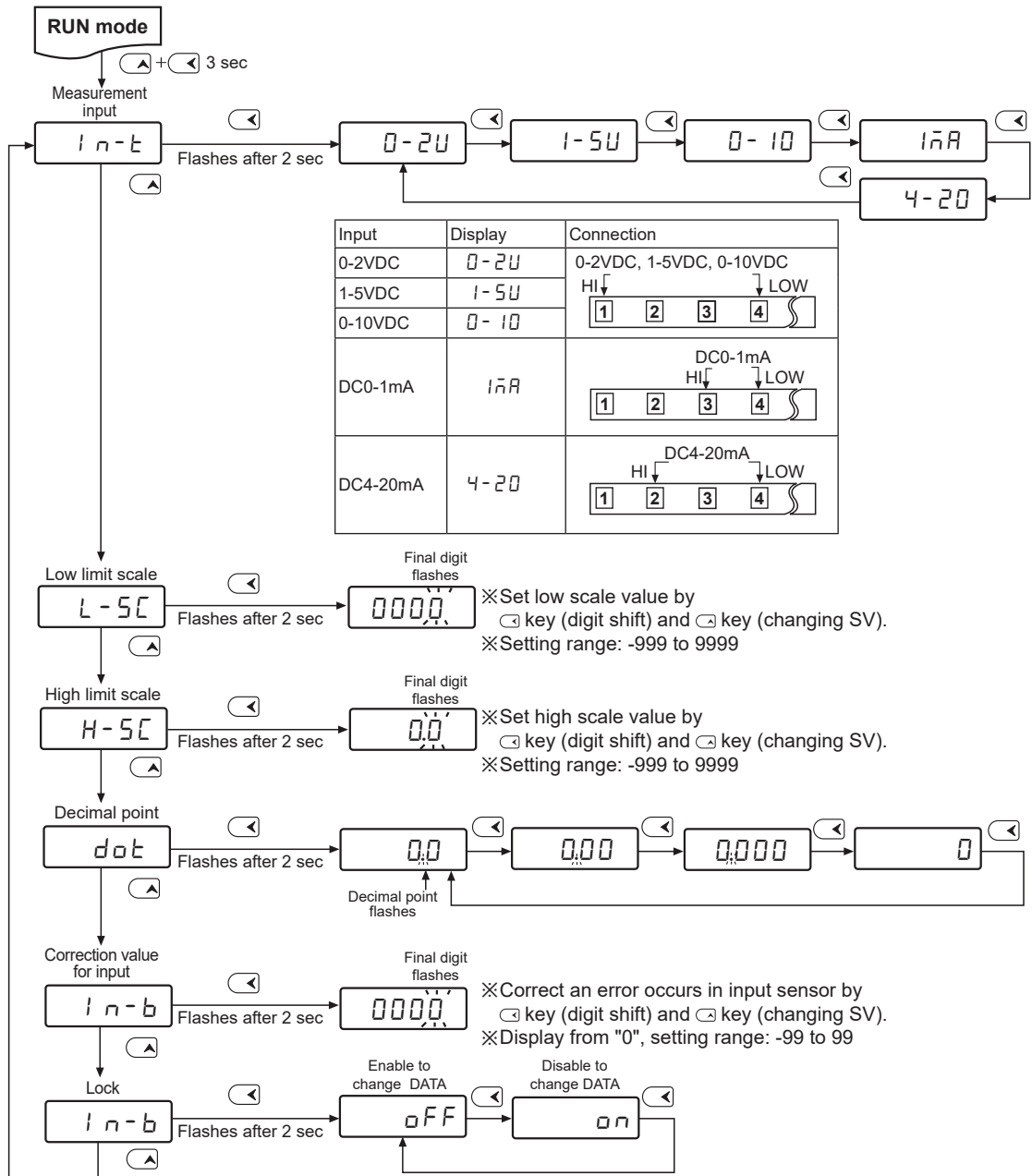

How to change the setting value

- When advance to MODE, change digit flashing by \leftarrow key then set DATA value by \leftarrow key.
- After complete DATA value setting, please press \leftarrow key for 2 sec then it will move to next MODE saving DATA.
- Press \leftarrow key for 2 sec to return RUN mode after changing (setting) DATA value in each MODE.

※ Press \leftarrow key for 2 sec, then it will return to RUN without change setting value.

※ When checking the setting value only in each mode. Press \leftarrow key for 2 sec, then press for 2 sec again.
 (If press continuously, it will not advance to next mode and return to RUN mode)

※ If any key is untouched for 60 sec, it will return to RUN mode.

| |
|-----------------------------------|
| SENSORS |
| CONTROLLERS |
| MOTION DEVICES |
| SOFTWARE |
| (J) Temperature Controllers |
| (K) SSRs |
| (L) Power Controllers |
| (M) Counters |
| (N) Timers |
| (O) Digital Panel Meters |
| (P) Indicators |
| (Q) Converters |
| (R) Digital Display Units |
| (S) Sensor Controllers |
| (T) Switching Mode Power Supplies |
| (U) Recorders |
| (V) HMIs |
| (W) Panel PC |
| (X) Field Network Devices |

Display Scale Function

This function is to display setting of particular high/low-limit value in order to display high/low-limit value of measurement input. If measurement inputs are a or b and display values are A or B, it will display a=A, b=B as below graph.

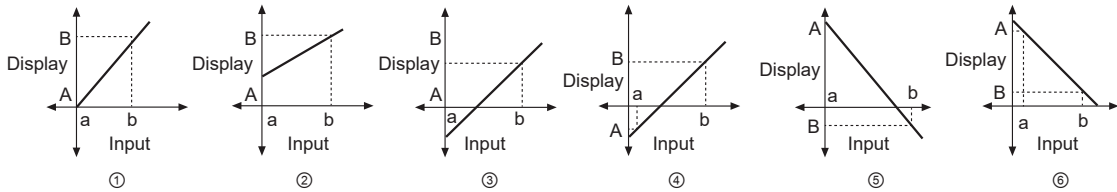

E.g.) Enables to set the display value for input as certain value (not "0") by using High/low-limit display scale function.

| Measurement input | Setting value | Display | Graph |
|-------------------|---------------------------------|-------------|-------|
| 0-10VDC | L-Scale: 0 H-Scale: 200 | 0 to 200 | ① |
| | L-Scale: 50 H-Scale: 200 | 50 to 200 | ② |
| | L-Scale: -100 H-Scale: 200 | -100 to 200 | ③ |
| | L-Scale: 200 H-Scale: -50 | 200 to -50 | ④ |

※High/low-limit value setting range → L - 5 [(low limit): -999 to 9999, H - 5 [(high limit): -999 to 9999
But, there must be offset "1" between L - 5 [and H - 5 [.

Error Display Function

Display indicates "Error" when wrong measurement input value is applied.

| Indication | Description | Clearance of Error |
|------------|---|---|
| LLLL | In case of lower value than measurement input value (in case of applying DC2mA when measurement input range is selected as DC4 to 20mA) | Promptly change the input to a value that falls within the specified range. |
| HHHH | In case of higher value than measurement input value (in case of applying DC22mA when measurement input range is selected as DC4 to 20mA) | |
| oUEr | In case of wrong wiring or measurement input error | Please cut off the power and then check measurement input. |
| Er-E | In case of damaging the memory chip by high frequency noise, strong surge noise | Consult your Autonics sales representative. |

Proper Usage

⚠ Cautions during use

- Follow instructions in 'Cautions during use'. Otherwise, it may cause unexpected accidents.
 - 12-24VDC power supply should be insulated and limited voltage/current or Class 2, SELV power supply device.
 - Install a power switch or circuit breaker in the easily accessible place for supplying or disconnecting the power.
 - Keep away from high voltage lines or power lines to prevent inductive noise.
- In case installing power line and input signal line closely, use line filter or varistor at power line and shielded wire at input signal line.
- Do not use near the equipment which generates strong magnetic force or high frequency noise.

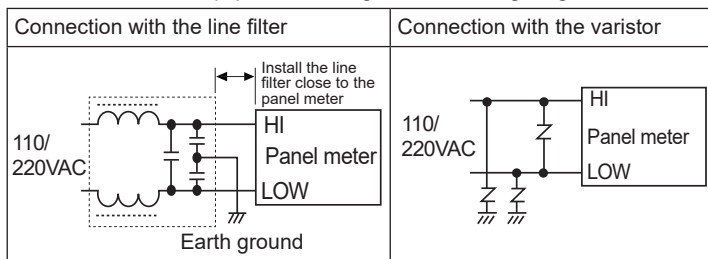

- This unit may be used in the following environments.

| | |
|--|----------------------------|
| ① Indoors (in the environment condition rated in 'Specifications') | ② Altitude max. 2,000m |
| ③ Pollution degree 2 | ④ Installation category II |