

# POSISTOR<sup>®</sup> for Circuit Protection



## for Overcurrent Protection 16V Series

2

This low-voltage, low-resistance type "POSISTOR" is a circuit protector whose resistance value in normal operation is very low and in abnormal situations like motor lock or short circuit, will be increased to restrain overcurrent. "POSISTOR" can be used for overcurrent protection against current fuse or temperature fuse, due to its ability to return to its initial condition when overcurrent is removed. This "POSISTOR" is most suitable for low-voltage circuits and motor protection for car applications.



PTGLS4/5

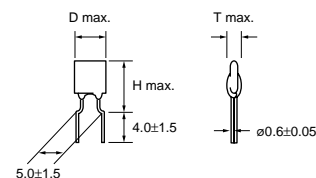

(in mm)

Type	D	T	H
PTGLS4AR1R0M1B53	5.5	4.0	9.5
PTGLS5AR0R8M1B53	6.0	4.0	10.0

### ■ Features

1. Best suited to meet the requirements for power supply and motor protection. Error-free operation is assured by rush current.
2. Circuit is protected until current is turned off.
3. Restores the original low resistance value automatically once the overload is removed.
4. Non-contact design leads to long life and no noise. Durable and strong against mechanical vibration and shock because it is a solid element.



PTGLS0/6/7/8/9

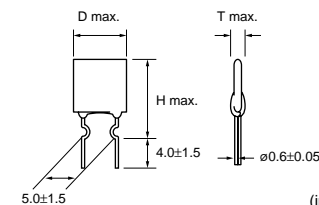

(in mm)

Type	D	T	H
PTGLS6ARR47M1B51	7.5	4.0	11.5
PTGLS7ARR33M1B51	8.0	4.0	12.0
PTGLS8ARR27M1B51	9.0	4.0	13.0
PTGLS9AR0R2M1B51	10.0	4.0	14.0
PTGLS0ARR15M1B51	11.5	4.0	15.5

### ■ Applications

1. Audio & Visual : DC Motor Protection
2. Car: Door Lock Motor  
Door Mirror Motor  
Shock Absorber Motor  
Actuator Motor Protection etc.
3. Others: Power Supply Circuit Protection

Part Number	Max. Voltage (V)	Non-operating Current at +60°C (mA)	Operating Current at -10°C (mA)	Max. Current (A)	Resistance (at 25°C) (ohm)	Curie Point (°C)	Body Diameter (D) (mm)	Thickness (T) (mm)	Lead Space (F) (mm)	Lead Diameter (phi d)(mm)
PTGLS4AR1R0M1B53B0	16	370	1040	2.0	1.0 ±20%	120 (AR)	5.5	4.0	5.0	0.6
PTGLS5AR0R8M1B53B0	16	400	1120	3.0	0.8 ±20%	120 (AR)	6.0	4.0	5.0	0.6
PTGLS6ARR47M1B51B0	16	560	1570	5.0	0.47 ±20%	120 (AR)	7.5	4.0	5.0	0.6
PTGLS7ARR33M1B51B0	16	680	1900	7.0	0.33 ±20%	120 (AR)	8.0	4.0	5.0	0.6
PTGLS8ARR27M1B51B0	16	800	2250	8.0	0.27 ±20%	120 (AR)	9.0	4.0	5.0	0.6
PTGLS9AR0R2M1B51B0	16	1000	2800	9.0	0.20 ±20%	120 (AR)	10.0	4.0	5.0	0.6
PTGLS0ARR15M1B51B0	16	1200	3360	10	0.15 ±20%	120 (AR)	11.5	4.0	5.0	0.6

Maximum Current shows typical capacities of the transformer which can be used.

The order quantity should be an integral multiple of the "Minimum Quantity" shown in the "Package" page.

Taping type is also available.

## ■ Protective Threshold Current Range

PTGLS4AR1R0M1B53B0

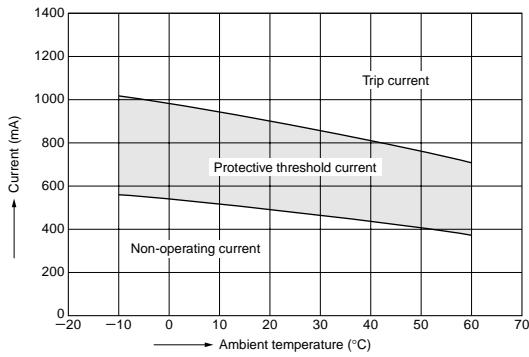

PTGLS5AR0R8M1B53B0

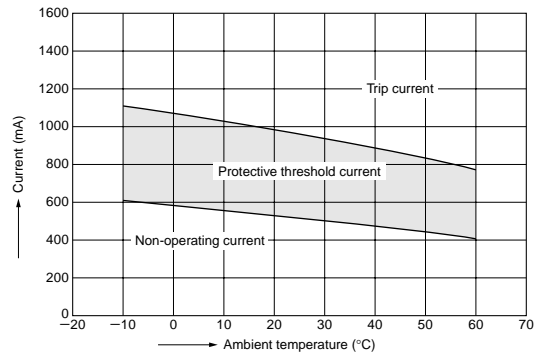

PTGLS6ARR47M1B51B0

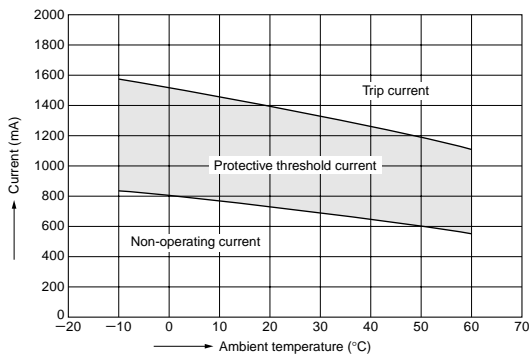

PTGLS7ARR33M1B51B0

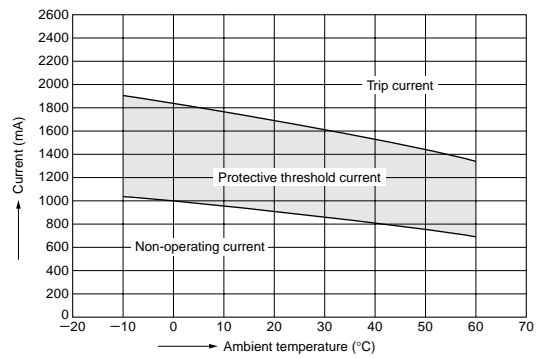

PTGLS8ARR27M1B51B0

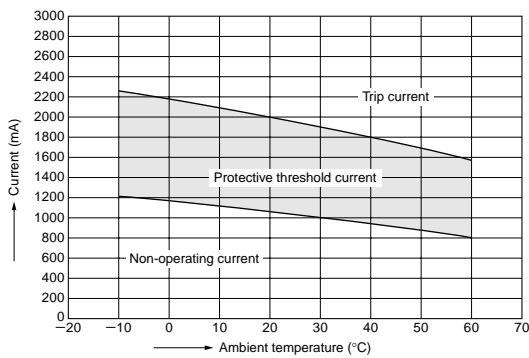

PTGLS9AR0R2M1B51B0

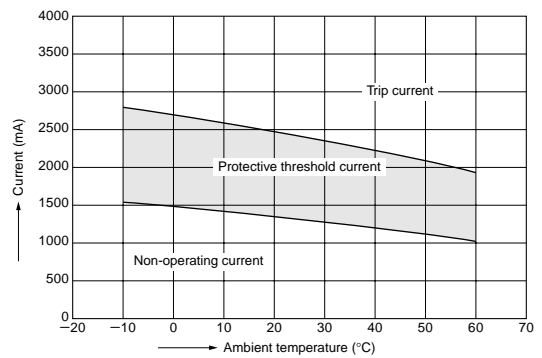

PTGLS0ARR15M1B51B0

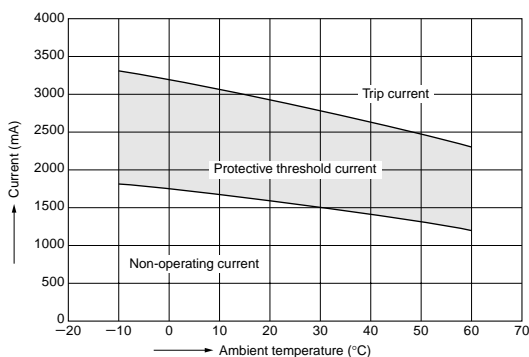

■ Operating Time (Typical Curve)

2

PTGLS4AR1R0M1B53B0

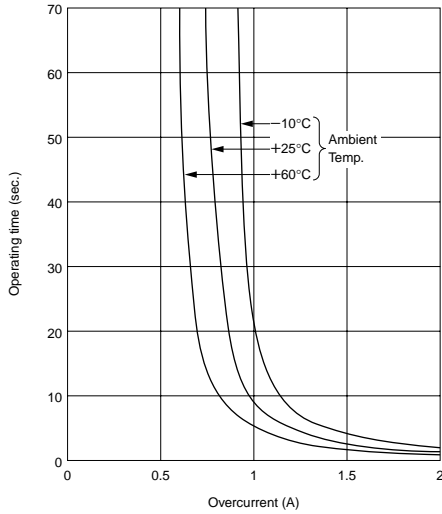

PTGLS5AR0R8M1B53B0

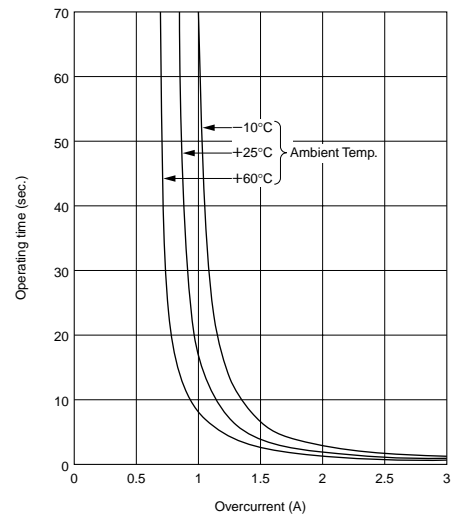

PTGLS6ARR47M1B51B0

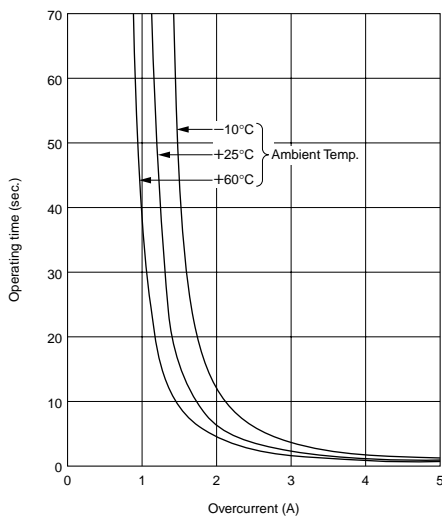

PTGLS7ARR33M1B51B0

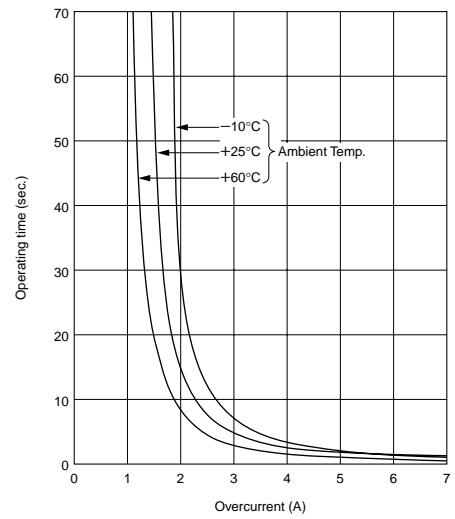

PTGLS8ARR27M1B51B0

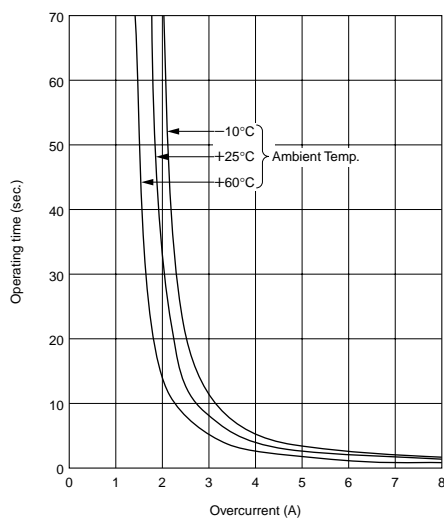

PTGLS9AR0R2M1B51B0

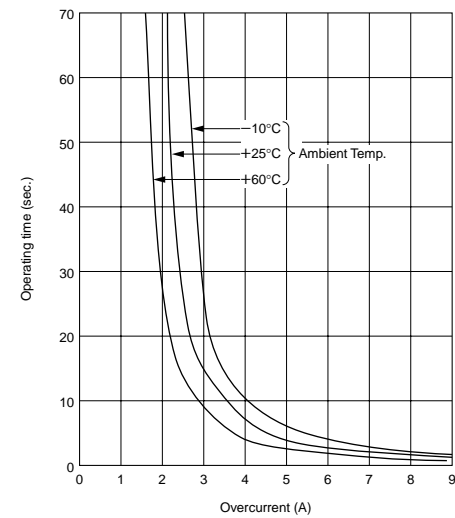

Continued from the preceding page.

### ■ Operating Time (Typical Curve)

PTGLS0ARR15M1B51B0

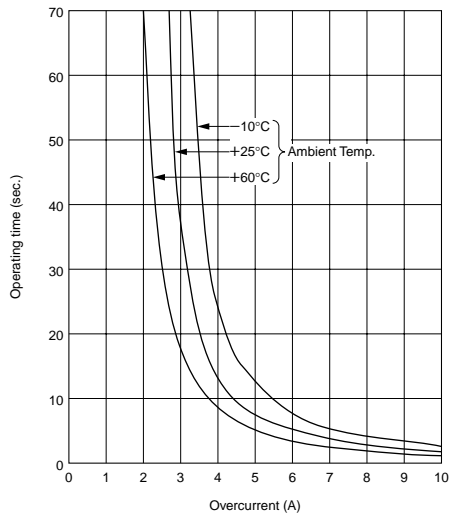

### ■ Application Circuit

(1) Transistor Protection Circuit

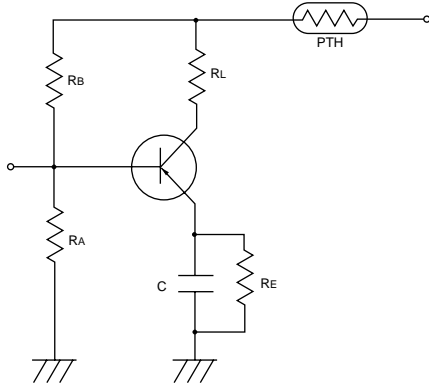

(2) DC Motor Protection Circuit

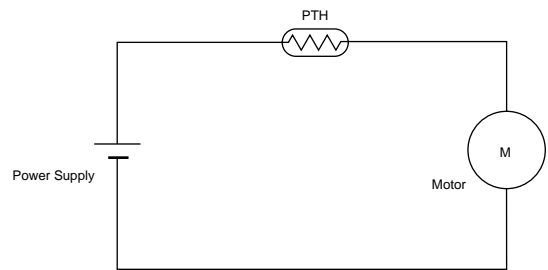

(3) Transformer Protection Circuit

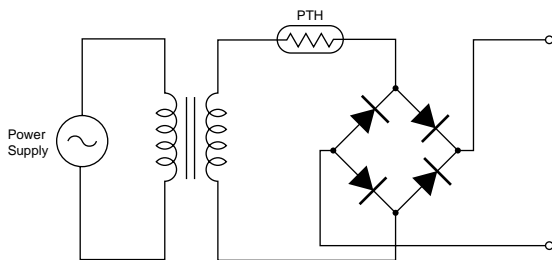

# POSISTOR<sup>®</sup> for Circuit Protection



## for Overcurrent Protection 24/30/32V Series

3

SAFETY RESISTOR "POSISTOR" is most suited to meet the requirements of the safety standard short-circuit tests such as IEC, VDE, BS, UL, etc. all over the world.

### ■ Features

1. Best suited to meet the requirements of the short-circuit test. Quick response compared with current fuse and resistor and error-free operation are assured.
2. Small size does not need a large space. Capable of being mounted to any place because replacement is not required.
3. Actuates by excessive current during the short-circuit test to restrain abnormal heat generation in other circuit components and printed boards. This state will be maintained until the abnormal state is removed or power is turned off to reset the "POSISTOR" to the original state. Surface temperature of "POSISTOR" is kept low, below a certain value, during the actuation.
4. Non-contact design leads to long life and no noise. Durable and strong against mechanical vibration and shock because it is a solid element.

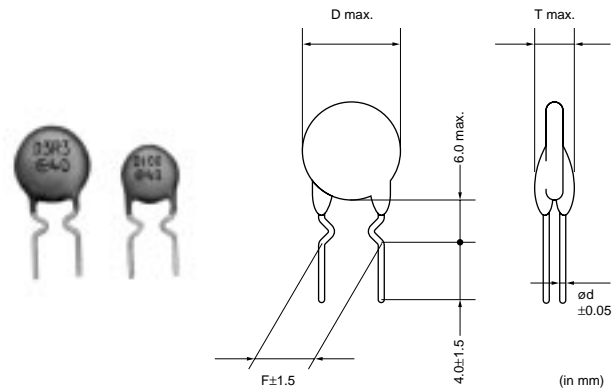

Part Number	Max. Voltage (V)	Non-operating Current at +60°C (mA)	Operating Current at -10°C (mA)	Max. Current (A)	Resistance (at 25°C) (ohm)	Curie Point (°C)	Body Diameter (D) (mm)	Thickness (T) (mm)	Lead Space (F) (mm)	Lead Diameter (phi d)(mm)
PTGL07BD100N2B51B0	24	80	320	2.0	10 ±30%	80 (BD)	7.4	4.0	5.0	0.6
PTGL07BD6R8N2B51B0	24	90	370	2.0	6.8 ±30%	80 (BD)	7.4	4.0	5.0	0.6
PTGL09BD4R7N2B51B0	24	120	500	2.0	4.7 ±30%	80 (BD)	9.5	4.0	5.0	0.6
PTGL09BD3R3N2B51B0	24	140	580	2.0	3.3 ±30%	80 (BD)	9.5	4.0	5.0	0.6
PTGL09BD2R2N2B51B0	24	180	710	2.0	2.2 ±30%	80 (BD)	9.5	4.0	5.0	0.6
PTGL04AR130H2B51B0	30	145	400	0.7	13 ±25%	120 (AR)	5.5	4.0	5.0	0.6
PTGL07AR4R6H2B51B0	30	250	700	2.0	4.6 ±25%	120 (AR)	7.4	4.0	5.0	0.6
PTGL09AR1R8H2B51B0	30	410	1120	3.0	1.8 ±25%	120 (AR)	9.5	4.0	5.0	0.6
PTGL12AR1R2H2B51B0	30	520	1420	4.3	1.2 ±25%	120 (AR)	12.0	4.0	5.0	0.6
PTGL13AR0R8H2B71B0	30	680	1900	5.5	0.8 ±25%	120 (AR)	13.5	4.0	7.5	0.6
PTGL07BD470N3B51B0	32	30	140	1.5	47 ±30%	80 (BD)	7.4	4.0	5.0	0.6
PTGL07BD330N3B51B0	32	40	170	1.5	33 ±30%	80 (BD)	7.4	4.0	5.0	0.6
PTGL07BD220N3B51B0	32	45	200	1.5	22 ±30%	80 (BD)	7.4	4.0	5.0	0.6
PTGL07BD150N3B51B0	32	60	240	1.5	15 ±30%	80 (BD)	7.4	4.0	5.0	0.6

Maximum Current shows typical capacities of the transformer which can be used.

The order quantity should be an integral multiple of the "Minimum Quantity" shown in the "Package" page.

PTGL\_51B0 series are available in taping type.

■ Protective Threshold Current Range (24V Series)

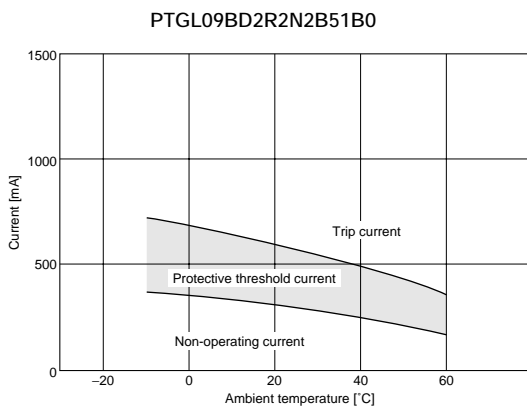
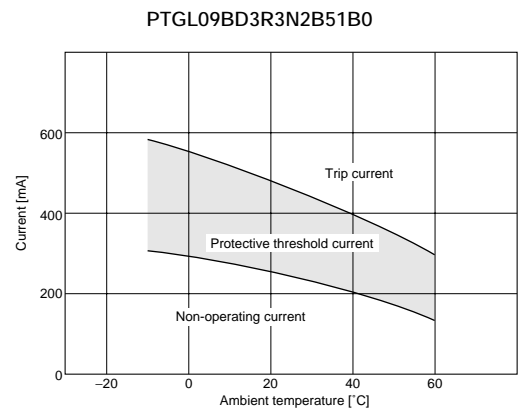
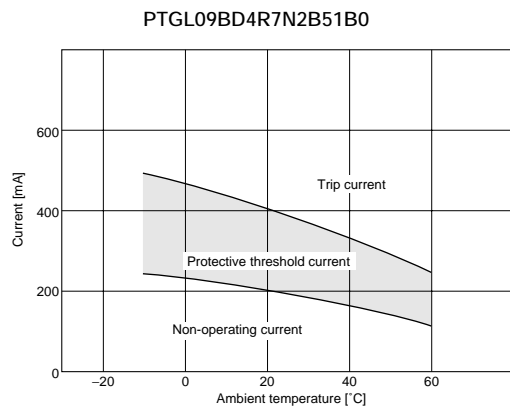
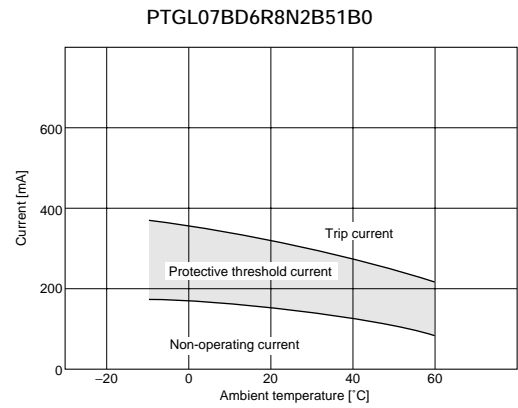
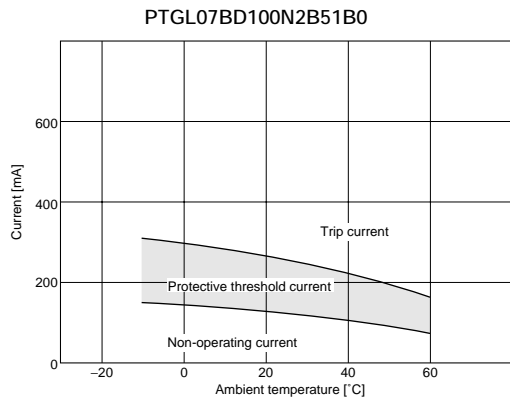

■ Protective Threshold Current Range (30V Series)

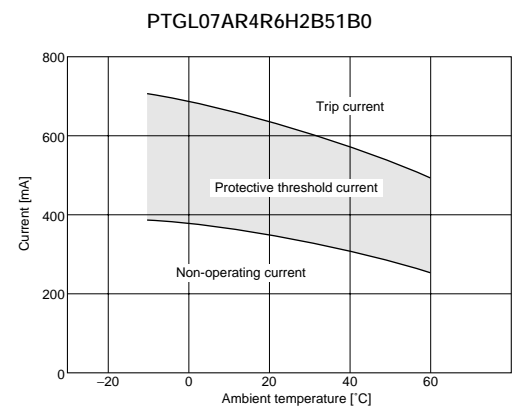
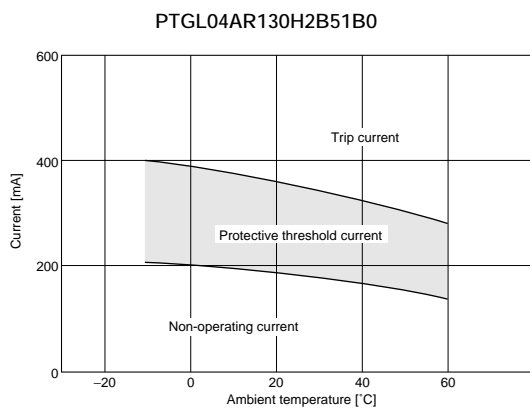

Continued from the preceding page.

■ Protective Threshold Current Range (30V Series)

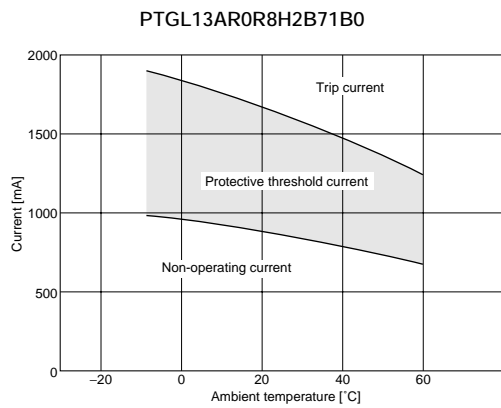
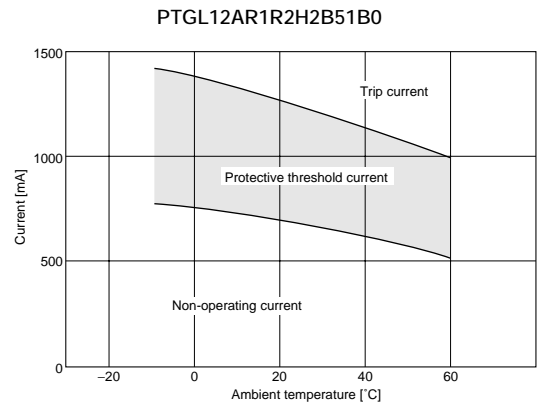
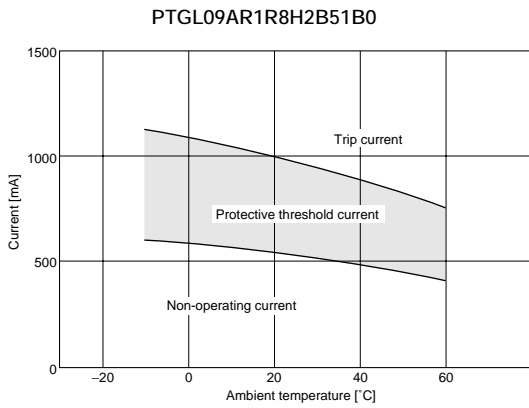

■ Protective Threshold Current Range (32V Series)

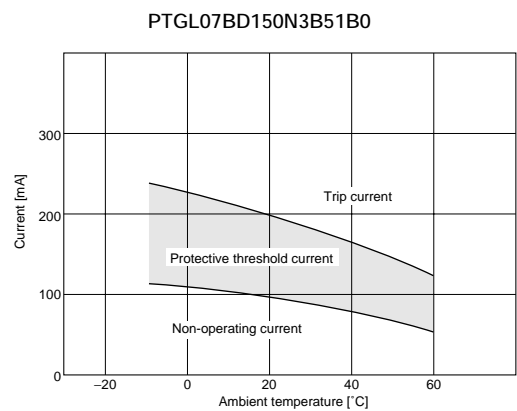
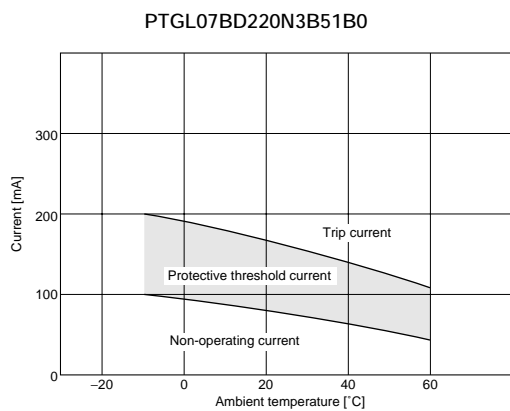
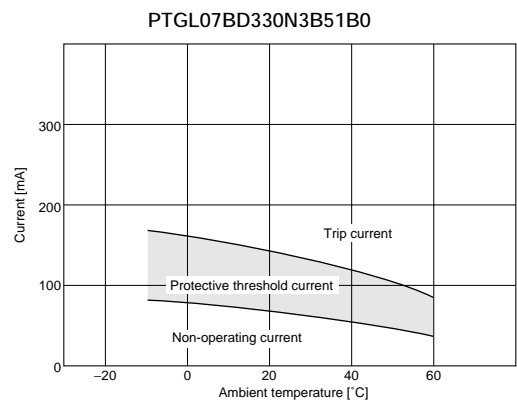
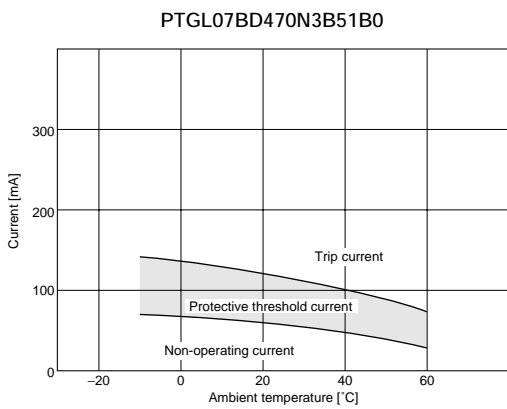

■ Operating Time 24V Series (Typical Curve)

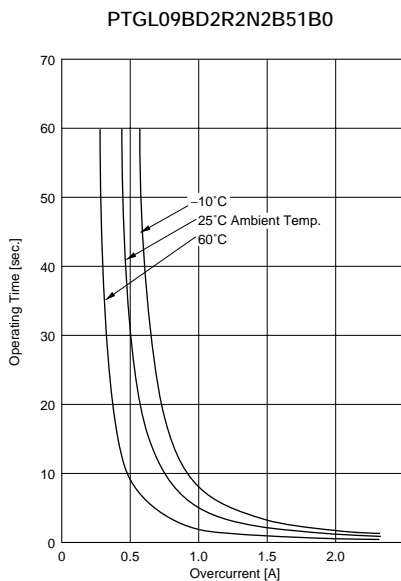
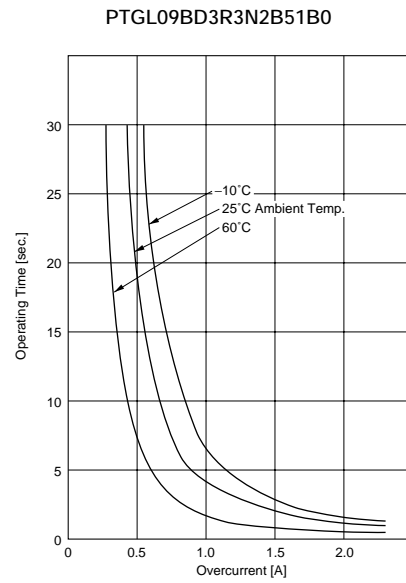
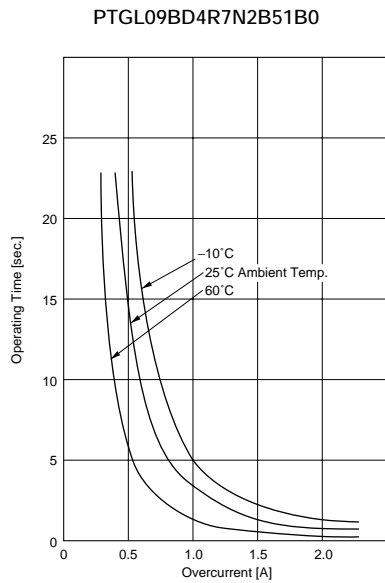
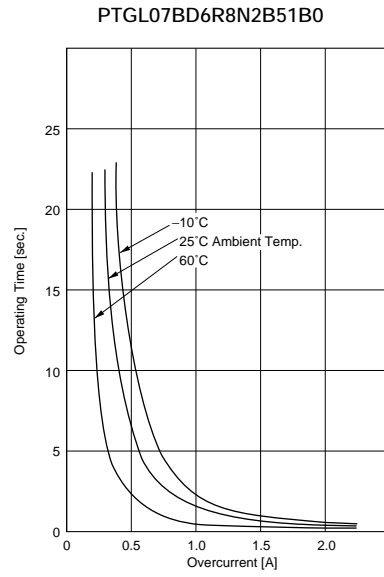
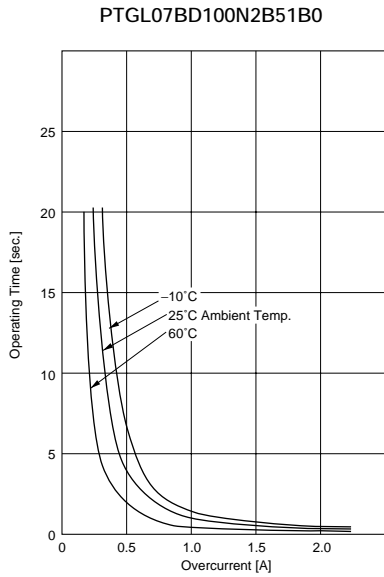



■ Operating Time 30V Series (Typical Curve)

3

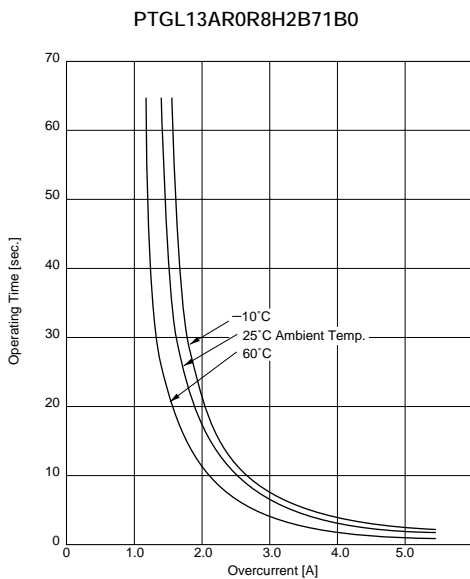
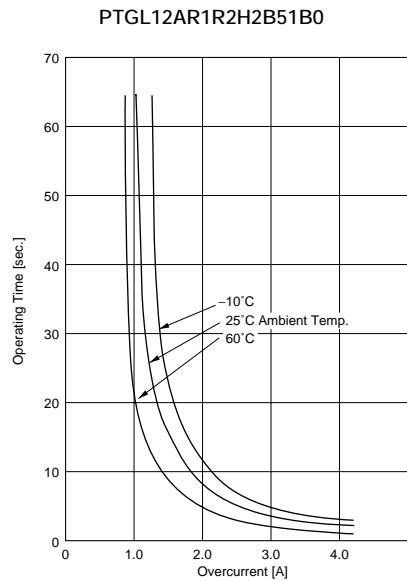
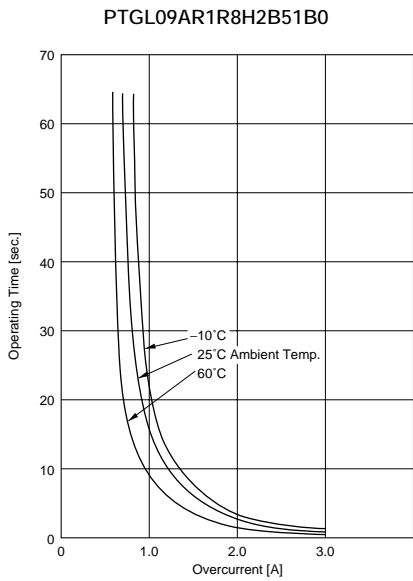
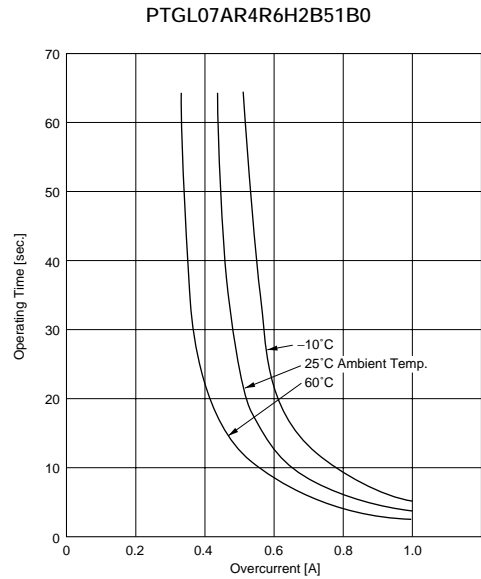
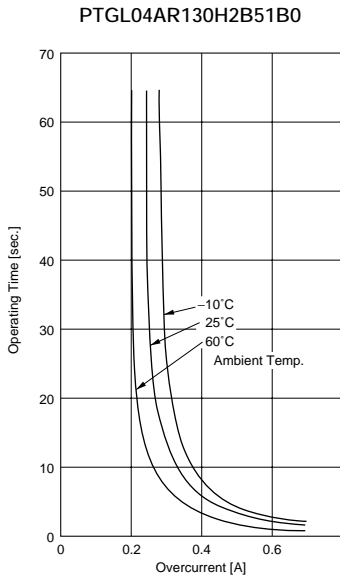

■ Operating Time 32V Series (Typical Curve)

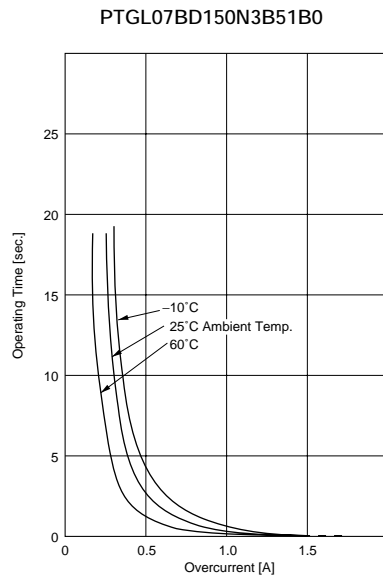
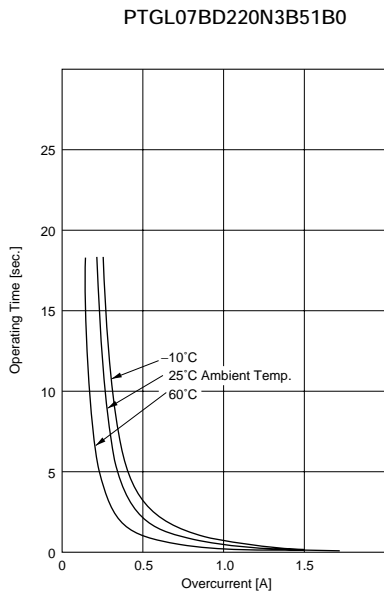
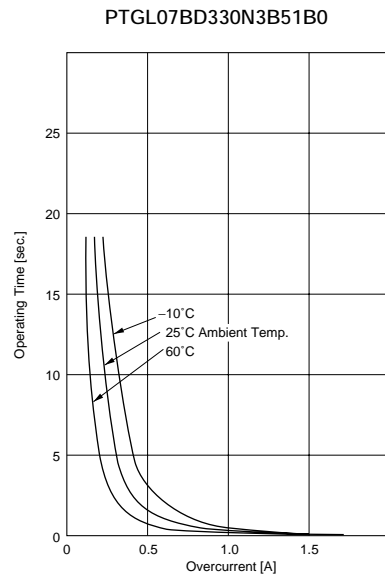
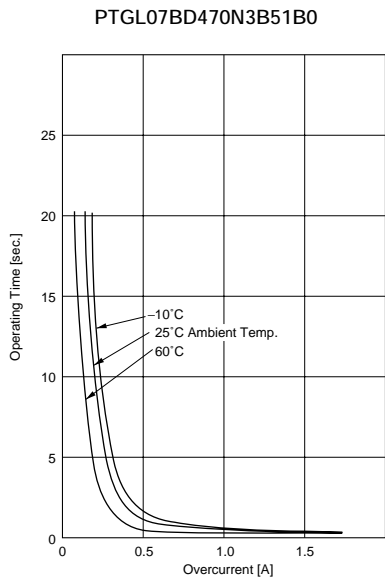

■ Application Circuit 24/32V Series

(1) Short-Circuit Test of Transistor

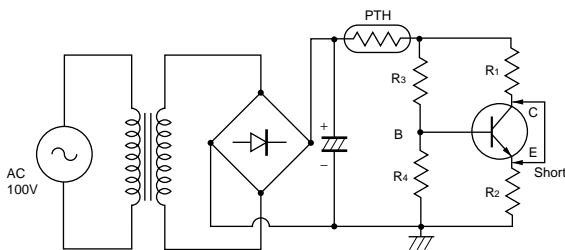

(2) Short-Circuit Test of Diode

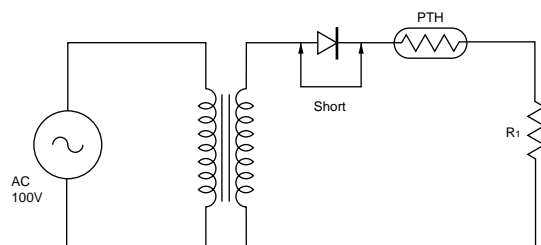

Continued on the following page. ↗

Continued from the preceding page.

### Application Circuit 24/32V Series

(3) Short-Circuit Test of IC

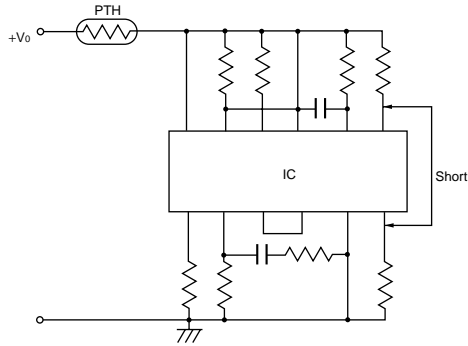

(4) Short-Circuit Test of Electrolytic Capacitor

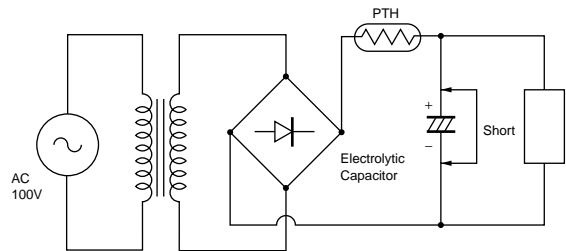

(5) Lock Test of Motor

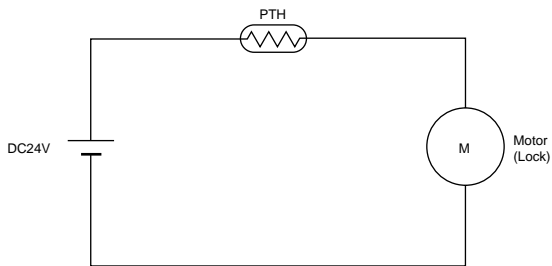

### Application Circuit 30V Series

(1) Transistor Protection Circuit

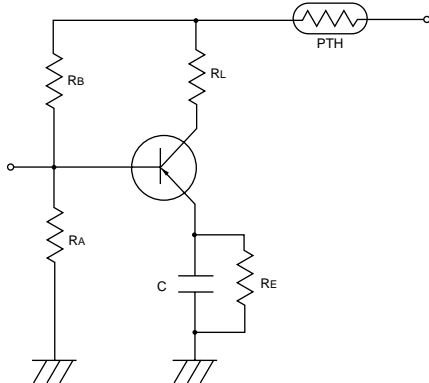

(2) Transformer Protection Circuit 1

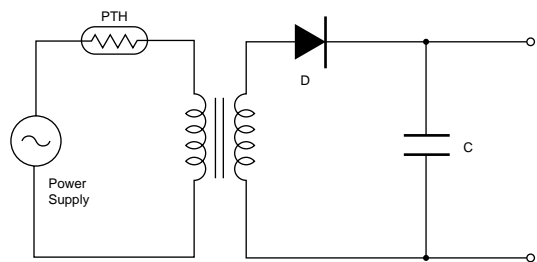

(3) Transformer Protection Circuit 2

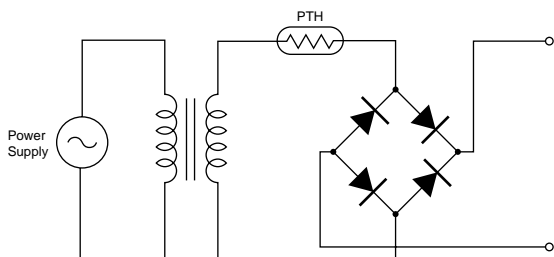

(4) Fluorescent Lamp Protection Circuit

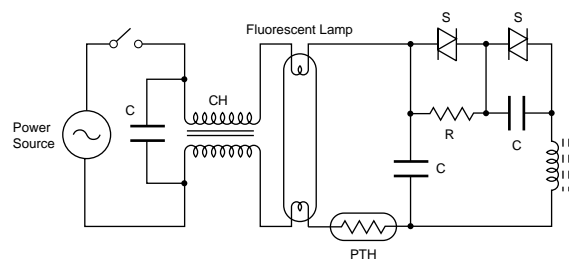

# POSISTOR<sup>®</sup> for Circuit Protection



## for Overcurrent Protection 56/80V Series

"POSISTOR" is a circuit protector whose resistance value in normal operation is very low and in abnormal situations like overcurrent or overheating, will be increased to restrain overcurrent. "POSISTOR" can be used for overcurrent protection against current fuse or temperature fuse, due to its ability to return to its initial condition when overcurrent is removed.

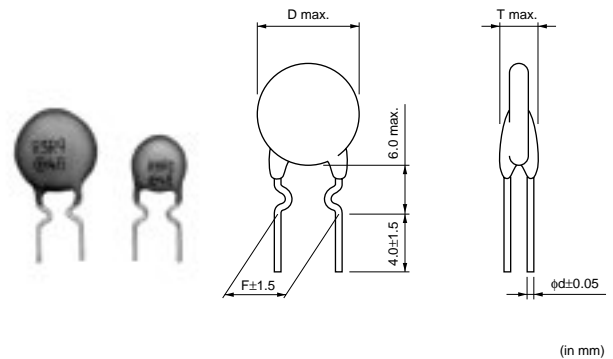

### ■ Features

1. Best suited to meet the requirements for power supply and motor protector. Error-free operations are assured by rush current.
2. Circuit is protected until current is turned off.
3. Restores the original low resistance value automatically once the overload is removed.
4. Non-contact design leads to long life and no noise. Durable and strong against mechanical vibration and shock because it is a solid element.

### ■ Applications

1. DC cooling fan motors in office equipment, e.g., computers, facsimiles, floppy disk drives and power units
2. DC drive motors in VTRs and cassette tape recorders. Power transformers (at secondary winding)

Part Number	Max. Voltage (V)	Non-operating Current at +60°C (mA)	Operating Current at -10°C (mA)	Max. Current (A)	Resistance (at 25°C) (ohm)	Curie Point (°C)	Body Diameter (D) (mm)	Thickness (T) (mm)	Lead Space (F) (mm)	Lead Diameter (phi d)(mm)
PTGL07AR220M3P51B0	56	90	240	1.0	22 ±20%	120 (AR)	7.4	4.0	5.0	0.6
PTGL07AR8R2M3P51B0	56	130	350	1.0	8.2 ±20%	120 (AR)	7.4	4.0	5.0	0.6
PTGL09AR150M3B51B0	56	150	400	1.2	15 ±20%	120 (AR)	9.5	4.0	5.0	0.6
PTGL10AR3R9M3P51B0	56	210	550	2.0	3.9 ±20%	120 (AR)	10.5	4.0	5.0	0.6
PTGL09AR4R7M3B51B0	56	270	700	2.0	4.7 ±20%	120 (AR)	9.5	4.0	5.0	0.6
PTGL10AR3R9M3B51B0	56	300	800	2.0	3.9 ±20%	120 (AR)	10.5	4.0	5.0	0.6
PTGL14AR3R3M3B71B0	56	380	980	2.5	3.3 ±20%	120 (AR)	14.5	4.0	7.5	0.6
PTGL05AR550H4P51B0	80	50	135	0.7	55 ±25%	120 (AR)	5.5	4.5	5.0	0.6
PTGL07AR250H4B51B0	80	110	300	1.0	25 ±25%	120 (AR)	7.4	4.5	5.0	0.6
PTGL09AR9R4H4B51B0	80	190	530	3.0	9.4 ±25%	120 (AR)	9.5	4.5	5.0	0.6
PTGL12AR5R6H4B71B0	80	270	760	4.3	5.6 ±25%	120 (AR)	12.0	4.5	7.5	0.6
PTGL13AR3R7H4B71B0	80	310	860	5.5	3.7 ±25%	120 (AR)	13.5	4.5	7.5	0.6

Maximum Current shows typical capacities of the transformer which can be used.

The order quantity should be an integral multiple of the "Minimum Quantity" shown in the "Package" page.

PTGL\_51B0 series are available in taping type.

■ Protective Threshold Current Range (56V Series)

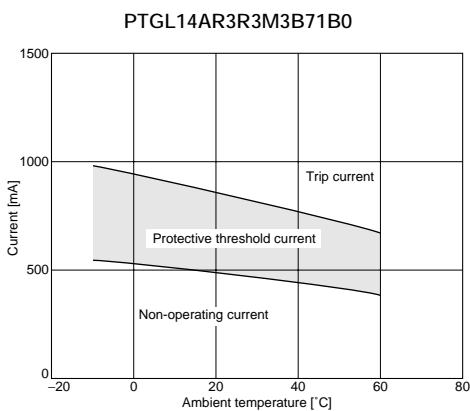
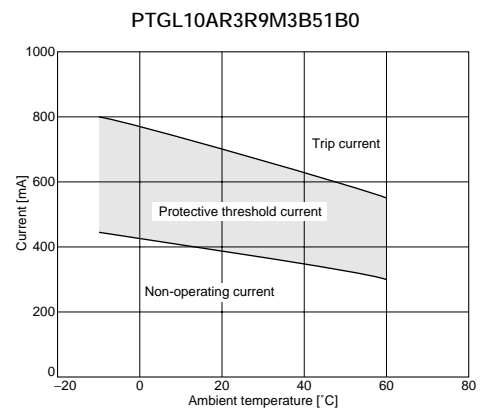
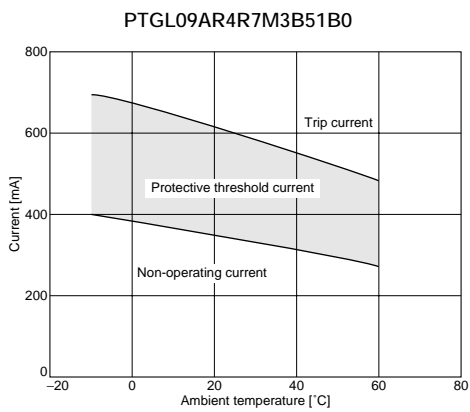
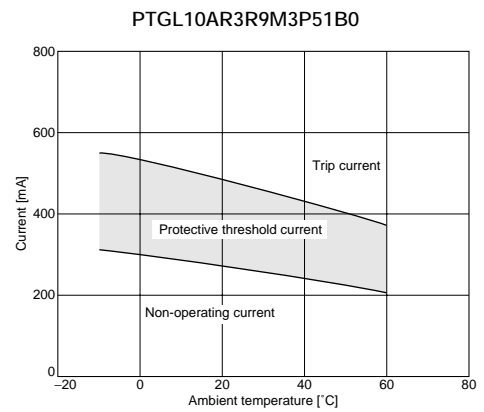
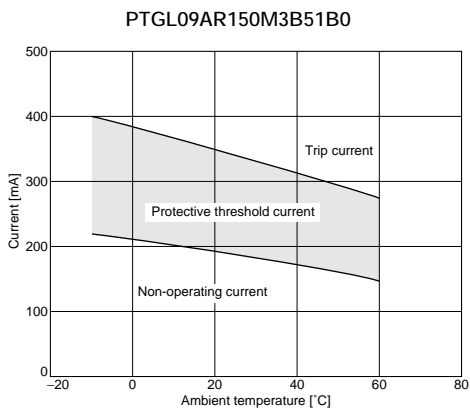
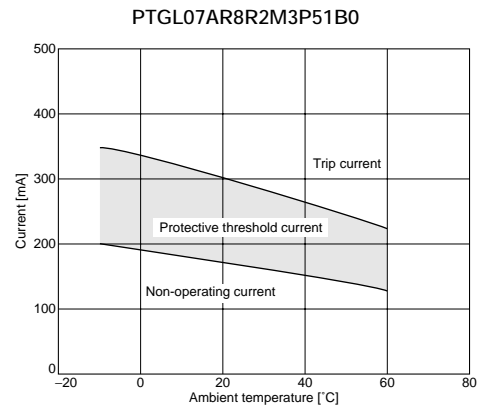
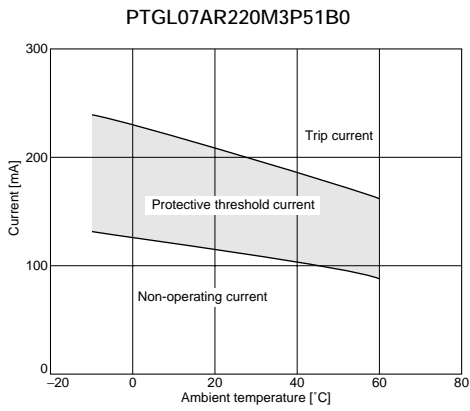

4

■ Protective Threshold Current Range (80V Series)

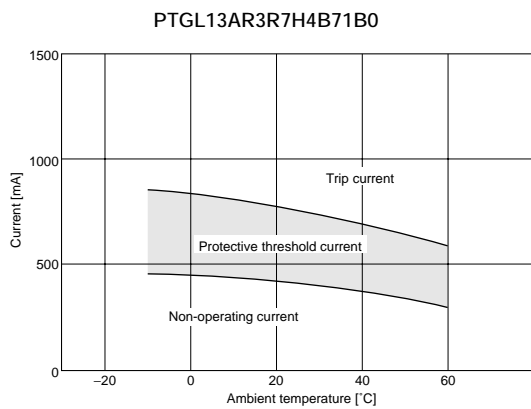
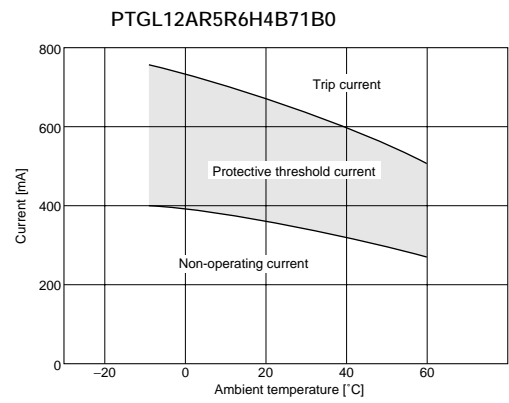
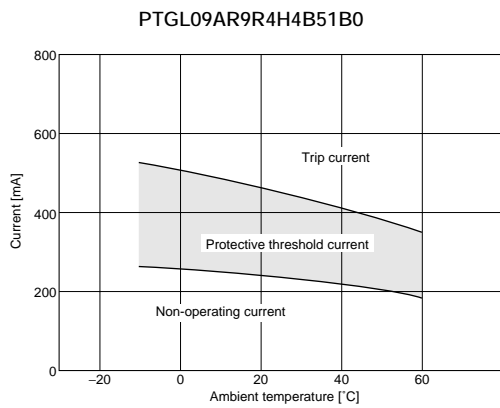
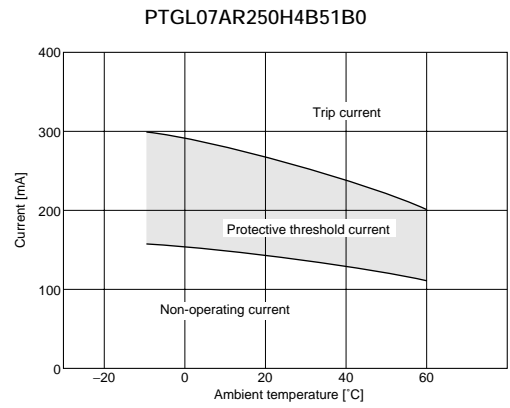
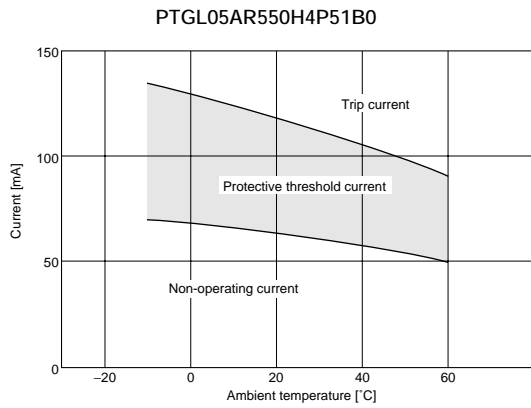

■ Operating Time 56V Series (Typical Curve)

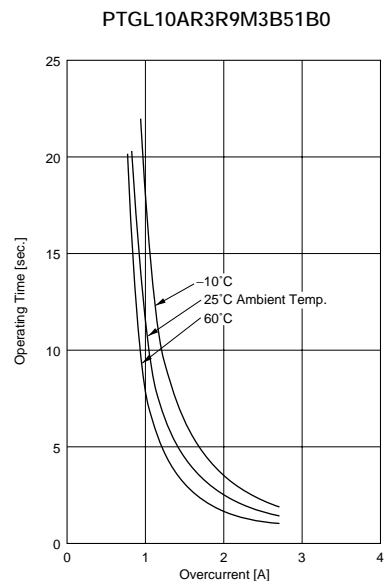
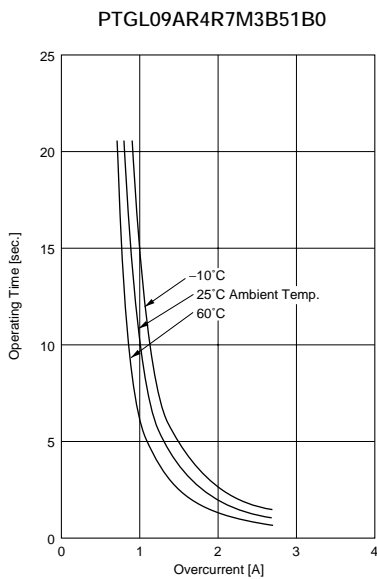
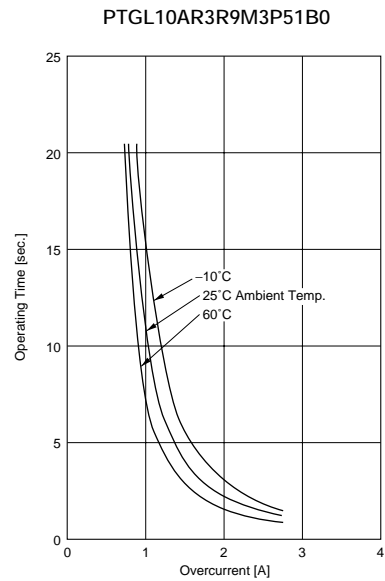
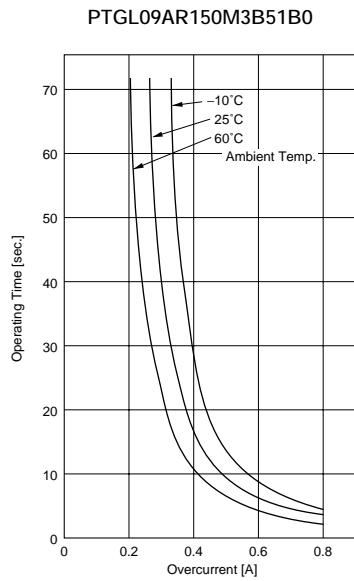
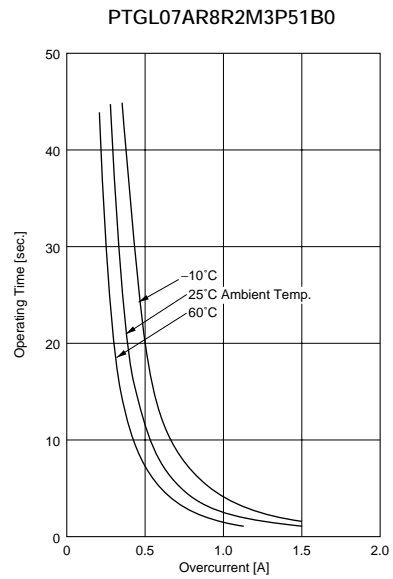
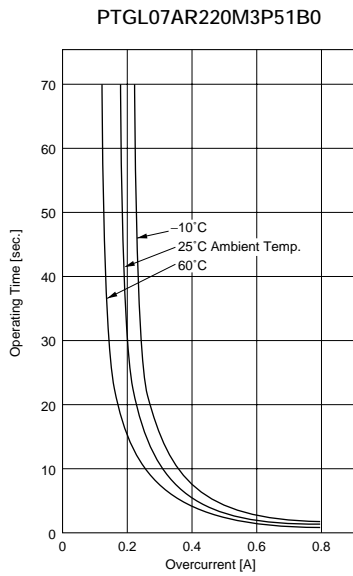

Continued from the preceding page.

■ Operating Time 56V Series (Typical Curve)

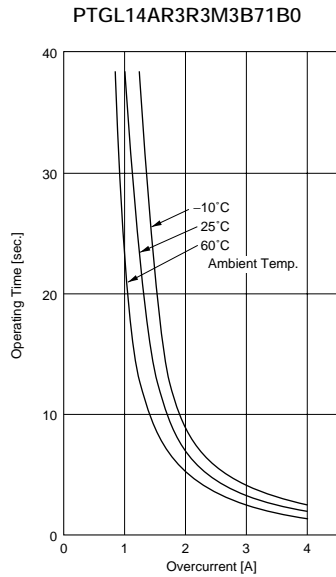

■ Operating Time 80V Series (Typical Curve)

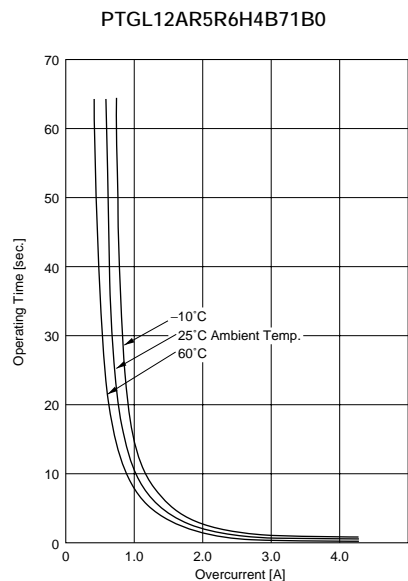
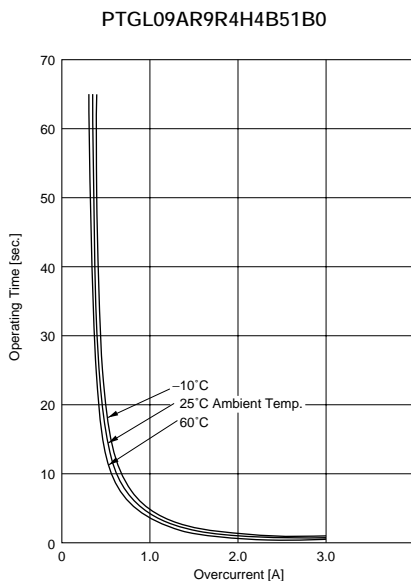
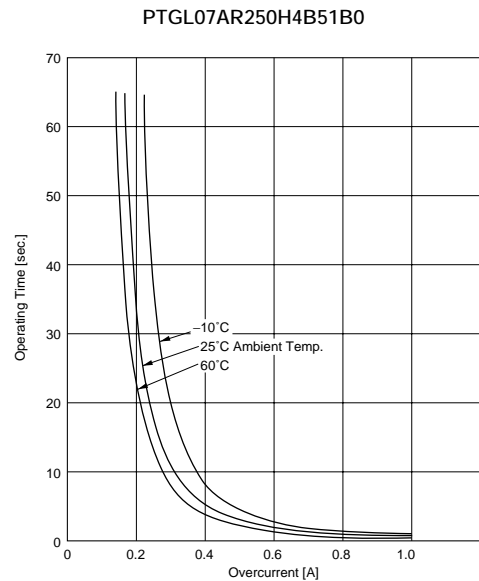
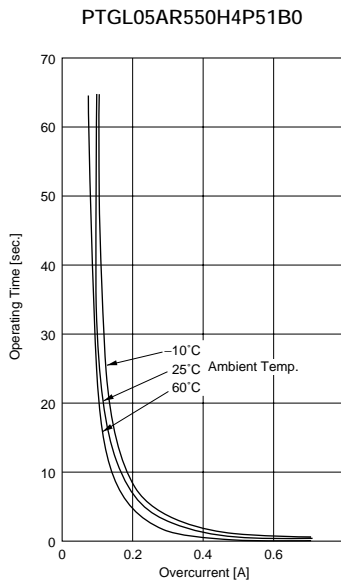

Continued on the following page. ↗



Continued from the preceding page.

### Operating Time 80V Series (Typical Curve)

PTGL13AR3R7H4B71B0

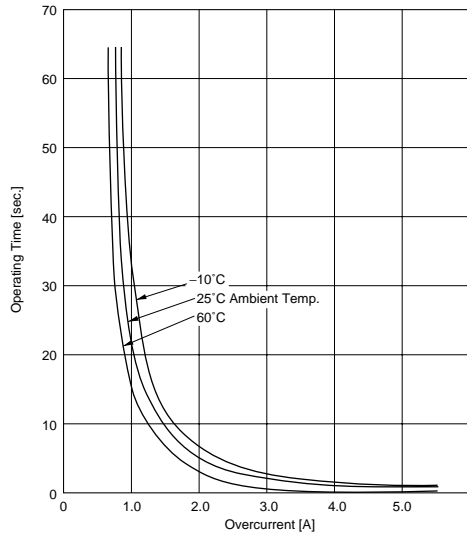

4

### Application Circuit 56V Series

DC Motor Protection Circuit

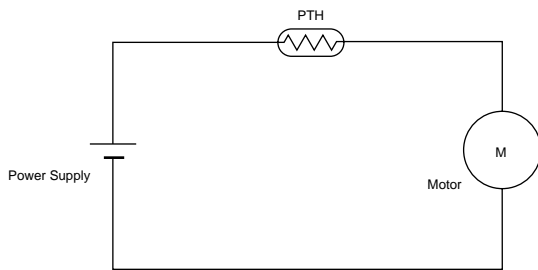

### Application Circuit 80V Series

(1) Transistor Protection Circuit

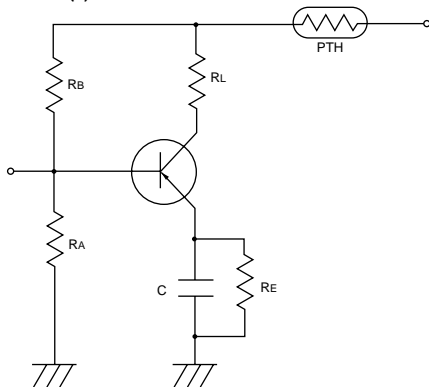

(2) Transistor Protection Circuit

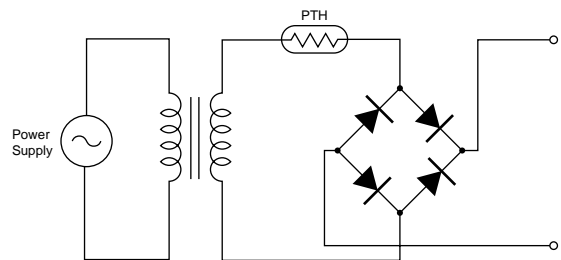

# POSISTOR<sup>®</sup> for Circuit Protection



## for Overcurrent Protection 125/140V Series

"POSISTOR" is a circuit protector whose resistance value in normal operation is very low and in abnormal situations like overcurrent or overheating, will be increased to restrain overcurrent. "POSISTOR" can be used for overcurrent protection against current fuse or temperature fuse, due to its ability to return to its initial condition when overcurrent is removed.

### ■ Features

1. Best suited to meet the requirements for power supply and motor protector. Error-free operations are assured by rush current.
2. Circuit is protected until current is turned off.
3. Restores the original low resistance value automatically once the overload is removed.
4. Non-contact design leads to long life and no noise. Durable and strong against mechanical vibration and shock because it is a solid element.

### ■ Applications

Circuit Protection :

1. Transformers
2. Transistors
3. Fluorescent Lamps

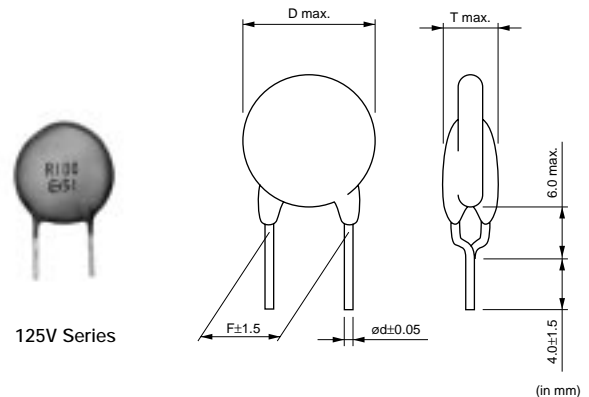

125V Series

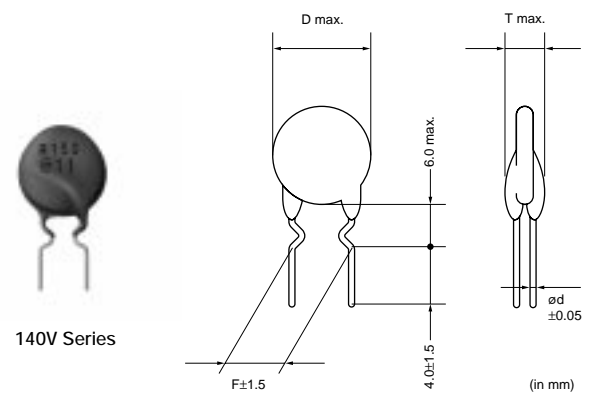

140V Series

Part Number	Max. Voltage (V)	Non-operating Current at +60°C (mA)	Operating Current at -10°C (mA)	Max. Current (A)	Resistance (at 25°C) (ohm)	Curie Point (°C)	Body Diameter (D) (mm)	Thickness (T) (mm)	Lead Space (F) (mm)	Lead Diameter (phi d)(mm)
PTGL05AR181M7P52B0	125	30	75	0.3	180 ±20%	120 (AR)	6.0	5.0	5.0	0.6
PTGL07AR750M7B52B0	125	65	165	0.3	75 ±20%	120 (AR)	8.0	6.0	5.0	0.6
PTGL09AR470M6B52B0	125	90	230	0.5	47 ±20%	120 (AR)	10.0	5.5	5.0	0.6
PTGL09AR220M6B52B0	125	135	340	0.8	22 ±20%	120 (AR)	10.0	5.5	5.0	0.6
PTGL12AR150M6B72B0	125	175	440	1.0	15 ±20%	120 (AR)	12.5	5.5	7.5	0.6
PTGL14AR100M6B72B0	125	220	550	1.2	10 ±20%	120 (AR)	15.0	5.5	7.5	0.6
PTGL18AR6R8M6B72B0	125	300	750	1.4	6.8 ±20%	120 (AR)	18.5	5.5	7.5	0.6
PTGL18AR4R7M6B72B0	125	360	900	1.7	4.7 ±20%	120 (AR)	18.5	5.5	7.5	0.6
PTGL18AR3R3M6B72B0	125	420	1050	2.0	3.3 ±20%	120 (AR)	18.5	5.5	7.5	0.6
PTGL07AR330M6A51B0	140	100	230	0.5	33 ±20%	120 (AR)	7.4	6.0	5.0	0.5
PTGL09AR220M6C61B0	140	140	330	1.0	22 ±20%	120 (AR)	9.6	6.0	6.5	0.65
PTGL10AR150M6C61B0	140	170	400	1.0	15 ±20%	120 (AR)	11.6	6.0	6.5	0.65
PTGL12AR100M6C01B0	140	220	510	1.0	10 ±20%	120 (AR)	13.0	6.0	10.0	0.65
PTGL13AR6R8M6C01B0	140	290	670	1.0	6.8 ±20%	120 (AR)	14.0	6.0	10.0	0.65
PTGL16AR5R6M6C01B0	140	340	780	2.0	5.6 ±20%	120 (AR)	17.0	6.0	10.0	0.65

Maximum Current shows typical capacities of the transformer which can be used.

Please contact us for UL approved products.

The order quantity should be an integral multiple of the "Minimum Quantity" shown in the "Package" page.

PTGL\_52B0 series are available in taping type.

■ Protective Threshold Current Range (125V Series)

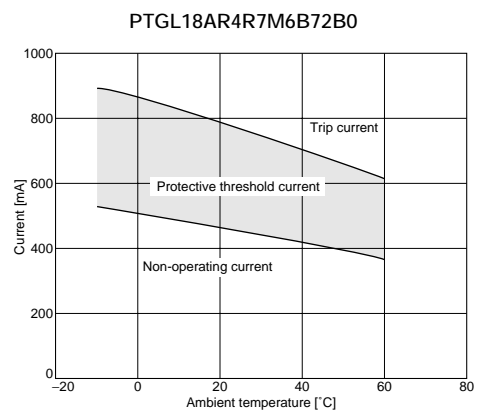
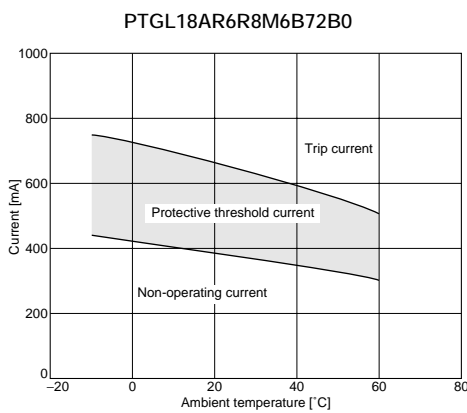
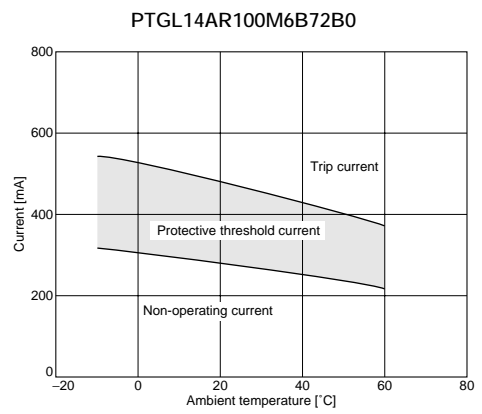
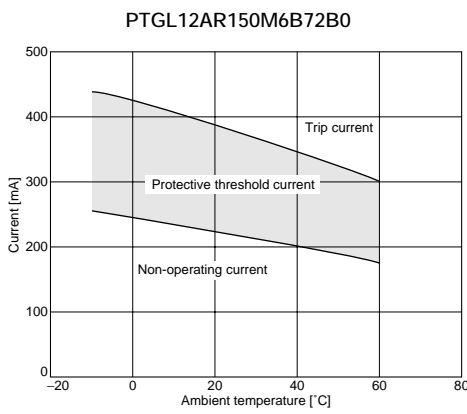
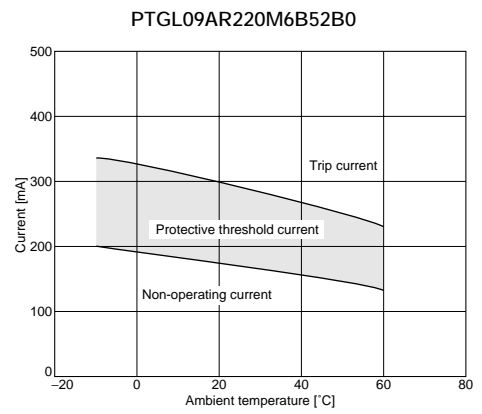
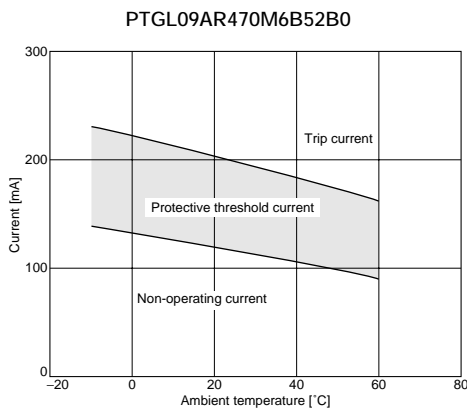
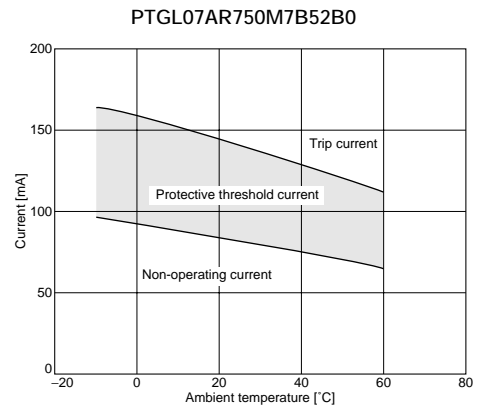
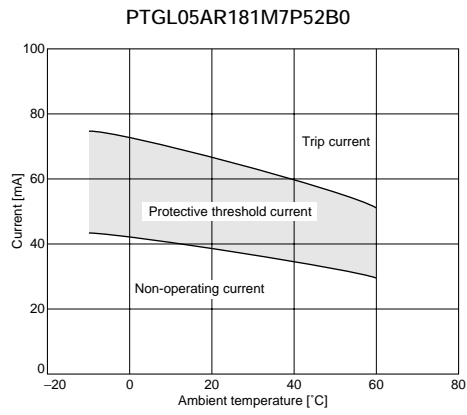

5

Continued from the preceding page.

■ Protective Threshold Current Range (125V Series)

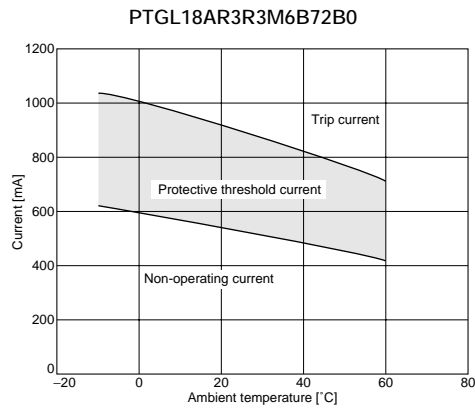

■ Protective Threshold Current Range (140V Series)

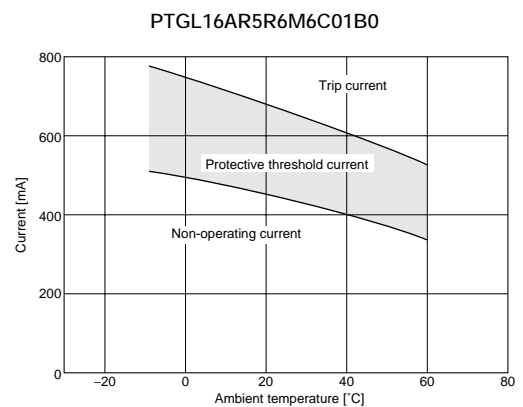
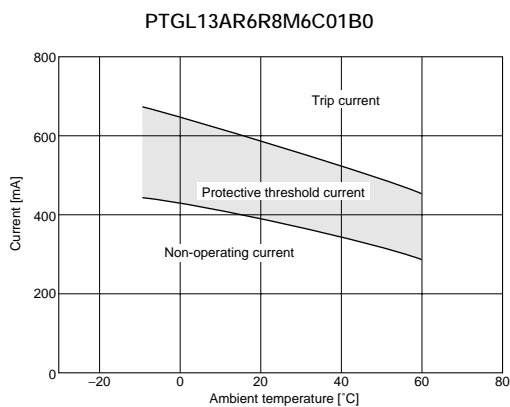
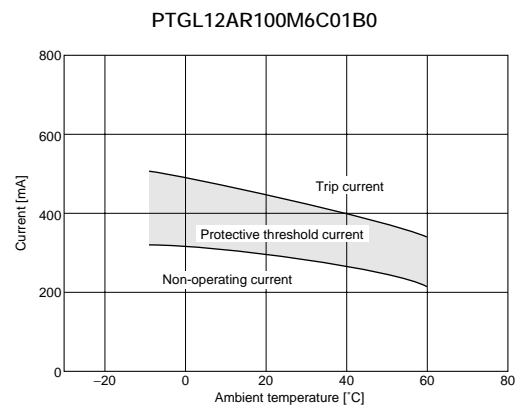
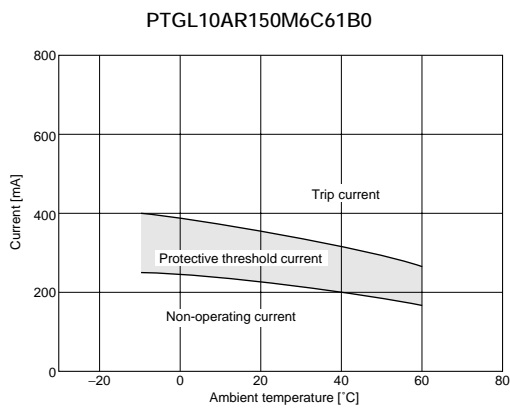
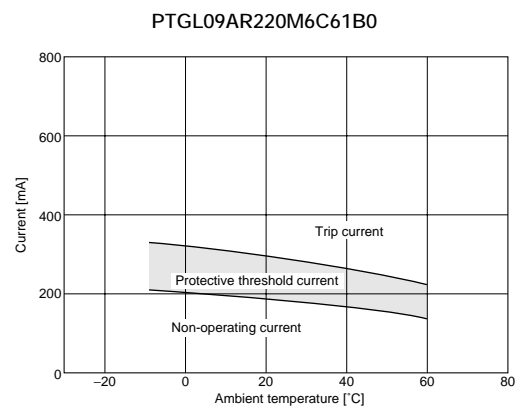
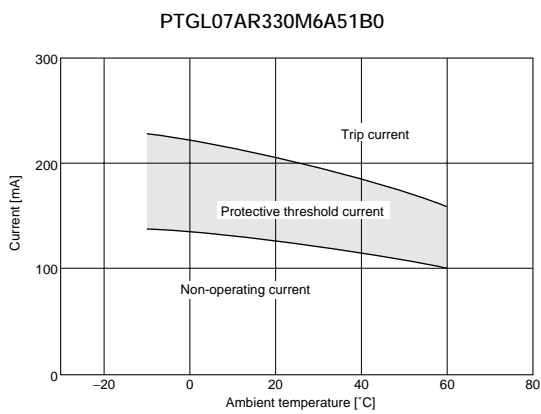

■ Operating Time 125V Series (Typical Curve)

PTGL05AR181M7P52B0

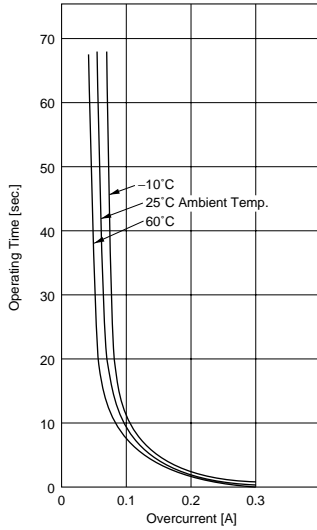

PTGL07AR750M7B52B0

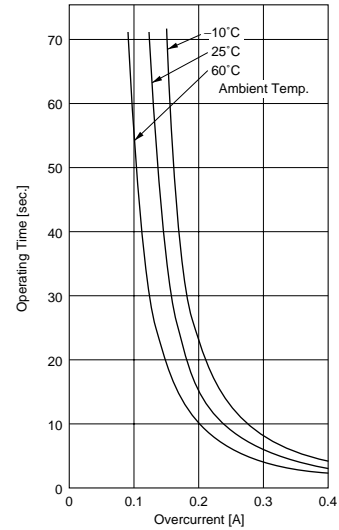

PTGL09AR470M6B52B0

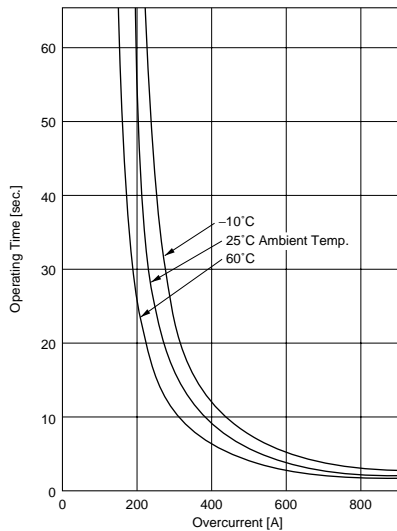

PTGL09AR220M6B52B0

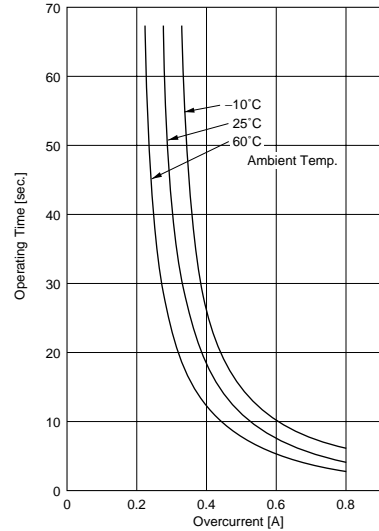

PTGL12AR150M6B72B0

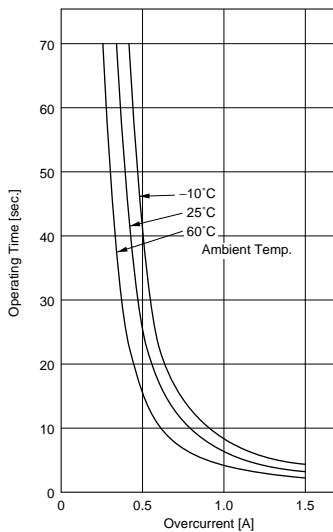

PTGL14AR100M6B72B0

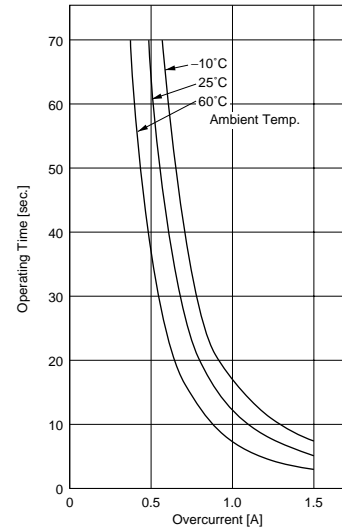

Continued from the preceding page.

■ Operating Time 125V Series (Typical Curve)

PTGL18AR6R8M6B72B0

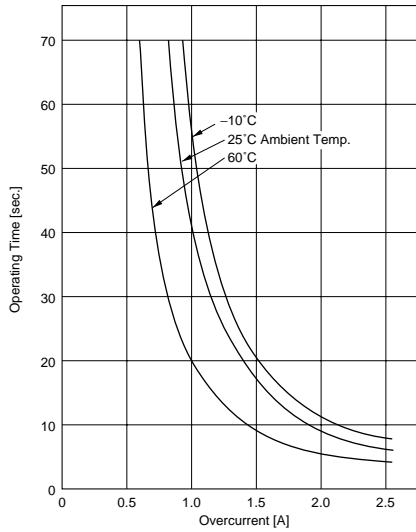

PTGL18AR4R7M6B72B0

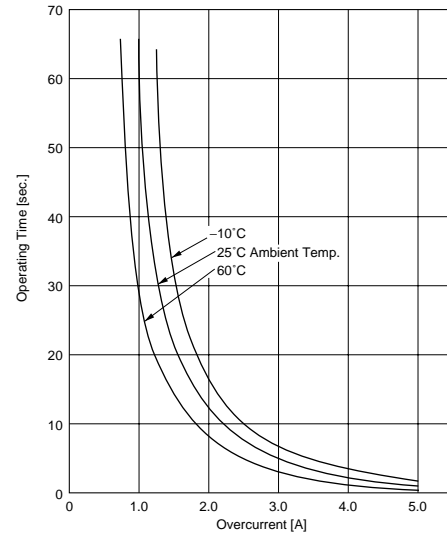

PTGL18AR3R3M6B72B0

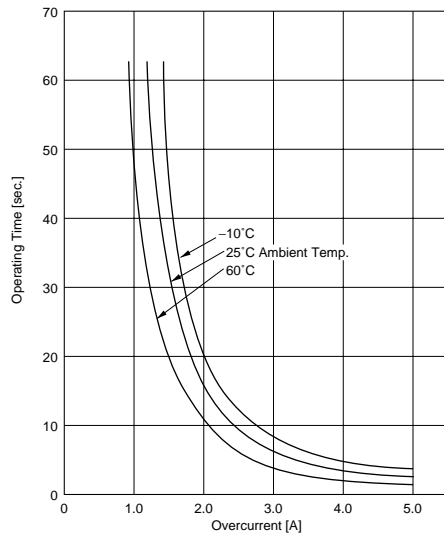

■ Operating Time 140V Series (Typical Curve)

PTGL07AR330M6A51B0

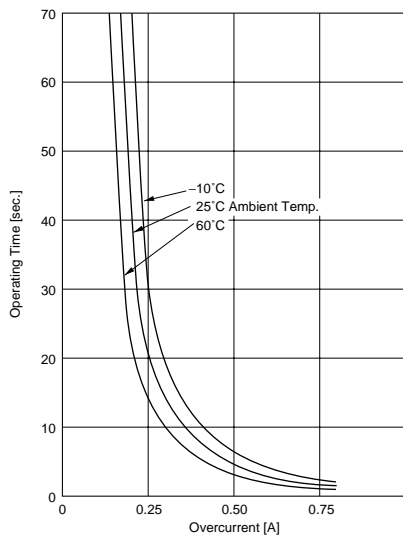

PTGL09AR220M6C61B0

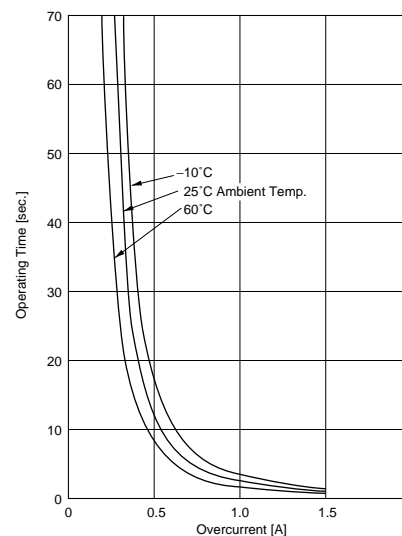

Continued on the following page. ↗

Continued from the preceding page.

■ Operating Time 140V Series (Typical Curve)

PTGL10AR150M6C61B0

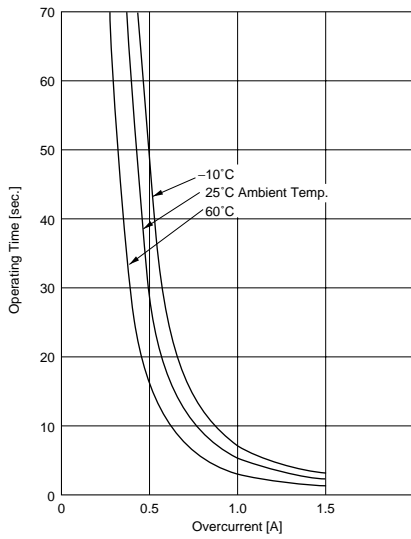

PTGL12AR100M6C01B0

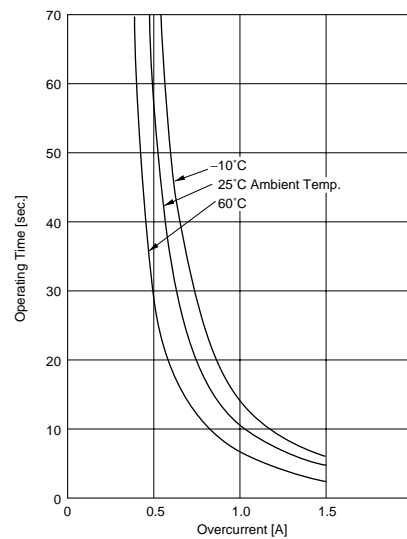

PTGL13AR6R8M6C01B0

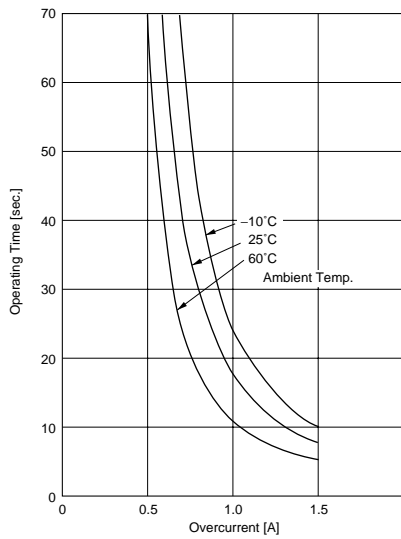

PTGL16AR5R6M6C01B0

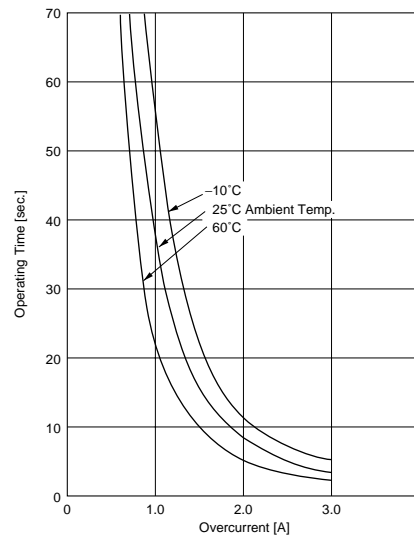

■ Application Circuit 125V Series

(1) Transformer Protection Circuit 1)

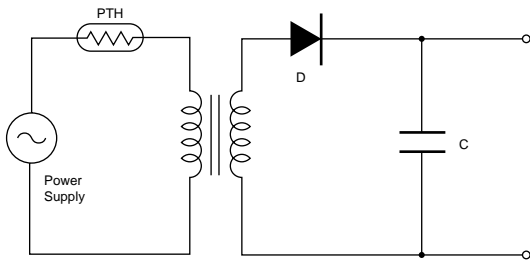

(2) Transformer Protection Circuit 2)

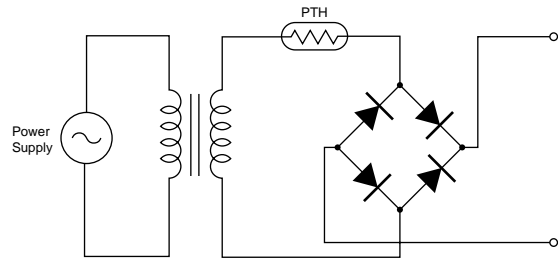

(3) Transistor Protection Circuit

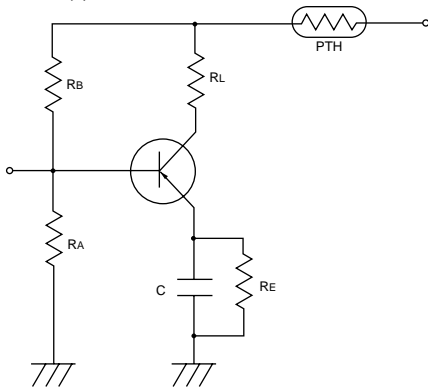

(4) Fluorescent Lamp Protection Circuit

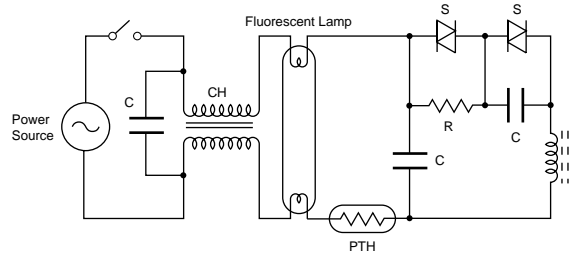

■ Application Circuit 140V Series

(1) Transformer Protection Circuit 1)

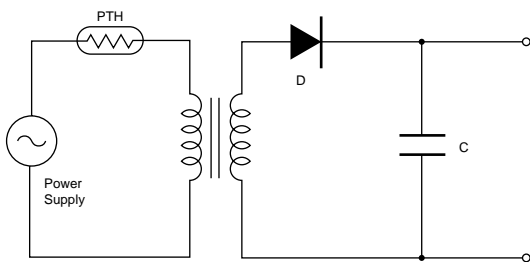

(2) Transformer Protection Circuit 2)

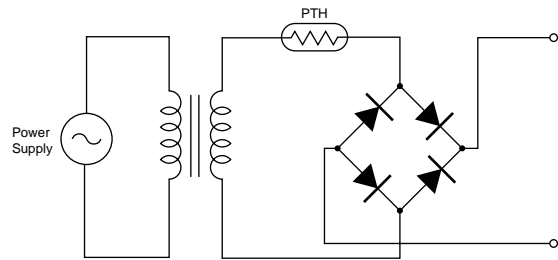



# POSISTOR<sup>®</sup> for Circuit Protection



## for Overcurrent Protection 250/265V Series

"POSISTOR" is a circuit protector whose resistance value in normal operation is very low and in abnormal situations like overcurrent or overheating, will be increased to restrain overcurrent. "POSISTOR" can be used for overcurrent protection against current fuse or temperature fuse, due to its ability to return to its initial condition when overcurrent is removed.

### ■ Features

1. Best suited to meet the requirements for power supply and motor protector. Error-free operations are assured by rush current.
2. Circuit is protected until current is turned off.
3. Restores the original low resistance value automatically once the overload is removed.
4. Non-contact design leads to long life and no noise. Durable and strong against mechanical vibration and shock because it is a solid element.

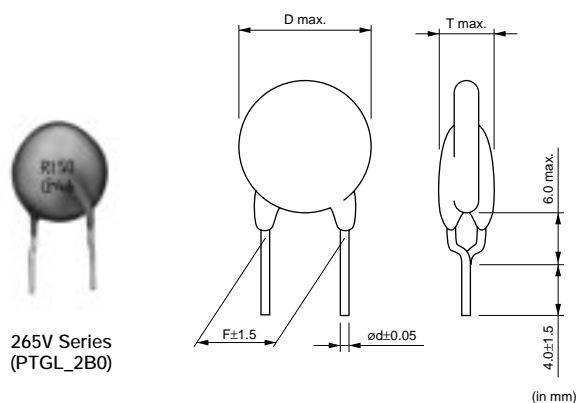
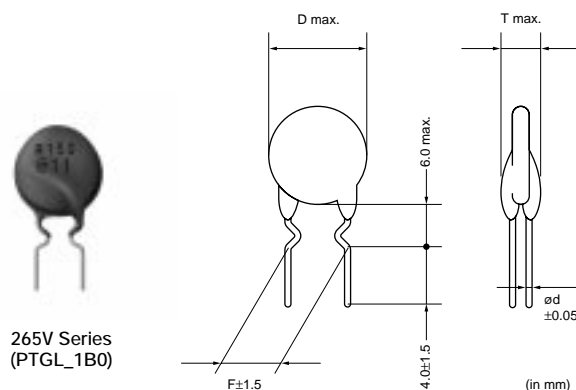
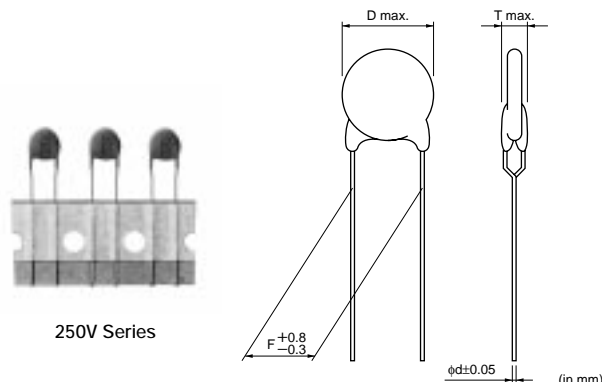

Part Number	Max. Voltage (V)	Non-operating Current at +60°C (mA)	Operating Current at -10°C (mA)	Max. Current (A)	Resistance (at 25°C) (ohm)	Curie Point (°C)	Body Diameter (D) (mm)	Thickness (T) (mm)	Lead Space (F) (mm)	Lead Diameter (phi d) (mm)
PTGL07BB220N0B52A0	250	90	300	0.5	22 ±30%	100 (BB)	8.0	6.0	5.0	0.6
PTGL10BB120N0P52A0	250	90	300	0.6	12 ±30%	100 (BB)	11.0	6.0	5.0	0.6
PTGL09AR390N0B52A0	250	100	280	0.6	39 ±30%	120 (AR)	10.0	6.0	5.0	0.6
PTGL05AR151H8P52B0	265	28	78	0.2	150 ±25%	120 (AR)	6.0	6.0	5.0	0.6
PTGL05AR181M9N51B0	265	29	70	0.3	180 ±20%	120 (AR)	6.5	6.5	5.0	0.5
PTGL05AR121M9N51B0	265	35	85	0.3	120 ±20%	120 (AR)	6.5	6.5	5.0	0.5
PTGL07AR820M9A51B0	265	60	150	0.5	82 ±20%	120 (AR)	8.2	6.5	5.0	0.5
PTGL07AR700H8B52B0	265	66	185	0.4	70 ±25%	120 (AR)	8.0	6.0	5.0	0.6
PTGL07AR650H8B52B0	265	68	190	1.0	65 ±25%	120 (AR)	8.0	6.0	5.0	0.6
PTGL07AR450H8B52B0	265	80	220	1.0	45 ±25%	120 (AR)	8.0	6.0	5.0	0.6
PTGL07AR560M9A51B0	265	80	190	0.8	56 ±20%	120 (AR)	8.2	6.5	5.0	0.5
PTGL09AR390M9C61B0	265	100	240	1.2	39 ±20%	120 (AR)	10.0	6.5	6.5	0.65

Continued on the following page.

Continued from the preceding page.

Part Number	Max. Voltage (V)	Non-operating Current at +60°C (mA)	Operating Current at -10°C (mA)	Max. Current (A)	Resistance (at 25°C) (ohm)	Curie Point (°C)	Body Diameter (D) (mm)	Thickness (T) (mm)	Lead Space (F) (mm)	Lead Diameter (phi d)(mm)
<b>PTGL09AR250H8B52B0</b>	265	118	330	1.0	25 ±25%	120 (AR)	10.0	6.0	5.0	0.6
<b>PTGL12AR270M9C01B0</b>	265	150	360	1.5	27 ±20%	120 (AR)	14.0	6.5	10.0	0.65
<b>PTGL12AR150H8B72B0</b>	265	165	460	1.5	15 ±25%	120 (AR)	12.5	6.0	7.5	0.6
<b>PTGL14AR180M9C01B0</b>	265	180	440	1.8	18 ±20%	120 (AR)	15.7	6.5	10.0	0.65
<b>PTGL13AR100H8B72B0</b>	265	200	560	2.2	10 ±25%	120 (AR)	14.0	6.0	7.5	0.6
<b>PTGL18AR6R0H8B72B0</b>	265	300	830	4.1	6.0 ±25%	120 (AR)	18.5	6.0	7.5	0.6

Maximum Current shows typical capacities of the transformer which can be used.

Please contact us for UL approved products.

The order quantity should be an integral multiple of the "Minimum Quantity" shown in the "Package" page.

PTGL\_5\*B0 series are available in taping type.

### ■ Protective Threshold Current Range (250V Series)

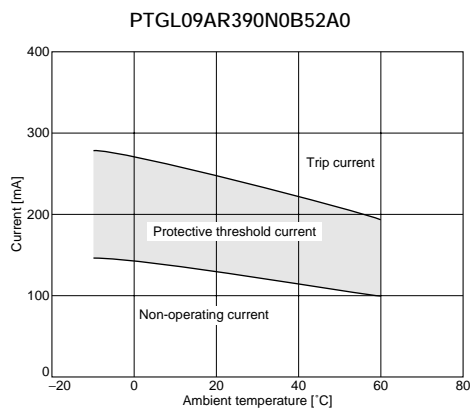
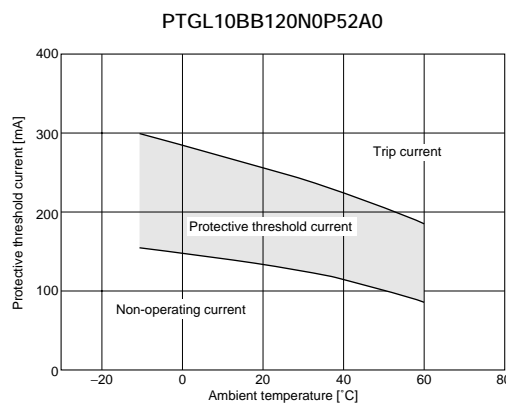
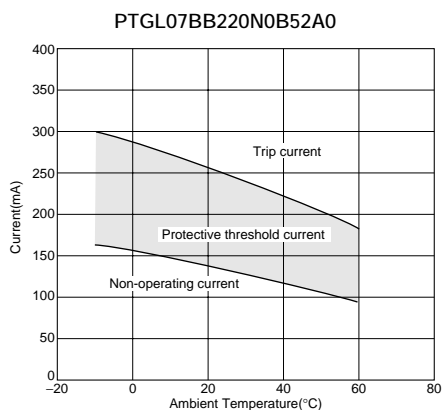

### ■ Protective Threshold Current Range (265V Series)

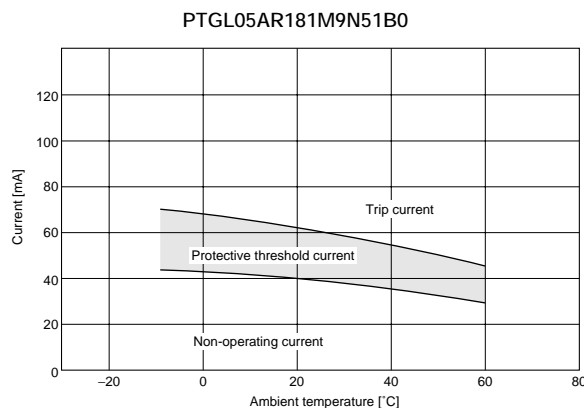
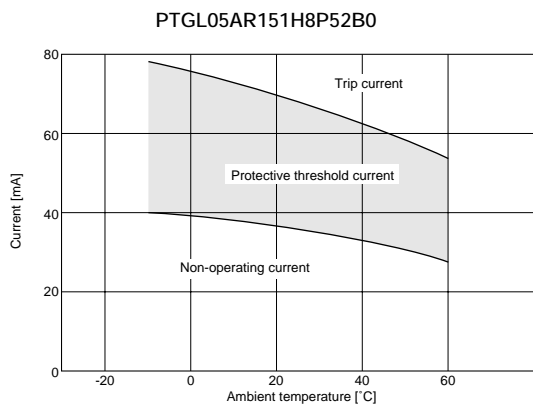

Continued on the following page. ↗

Continued from the preceding page.

■ Protective Threshold Current Range (265V Series)

PTGL05AR121M9N51B0

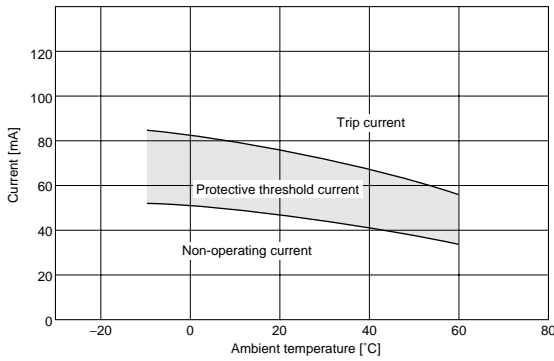

PTGL07AR820M9A51B0

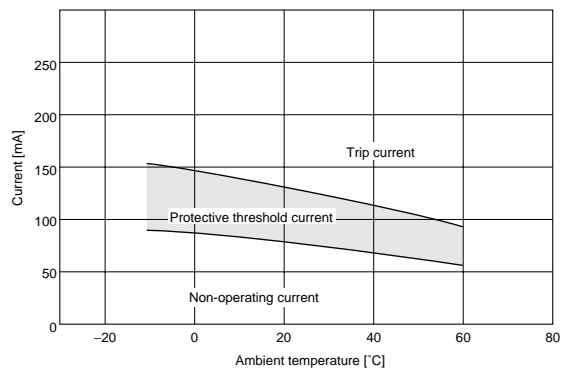

PTGL07AR700H8B52B0

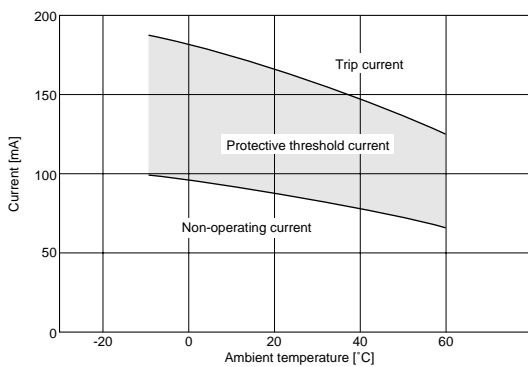

PTGL07AR650H8B52B0

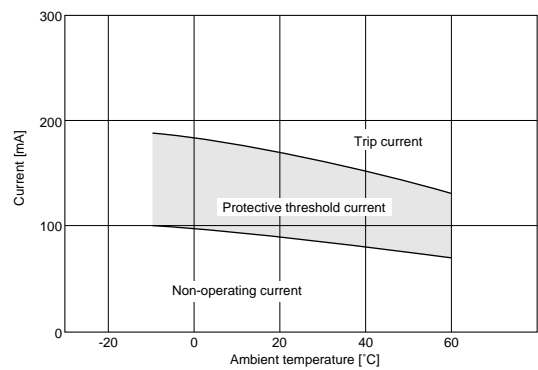

PTGL07AR450H8B52B0

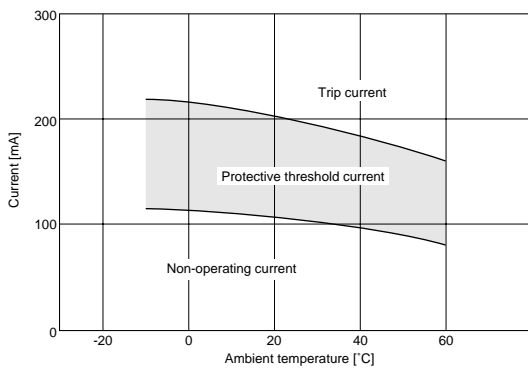

PTGL07AR560M9A51B0

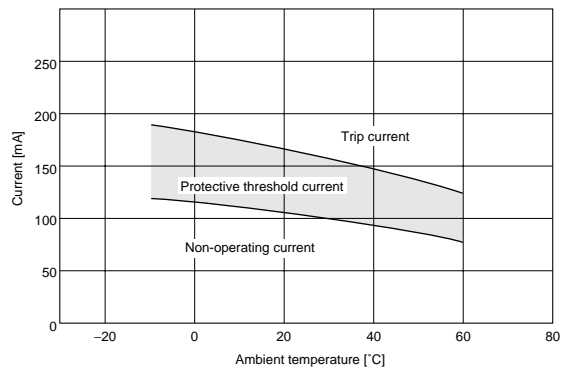

PTGL09AR390M9C61B0

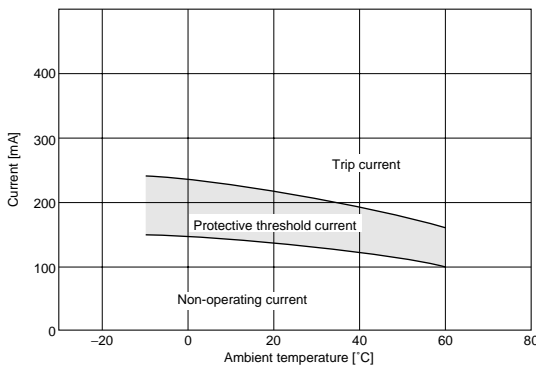

PTGL09AR250H8B52B0

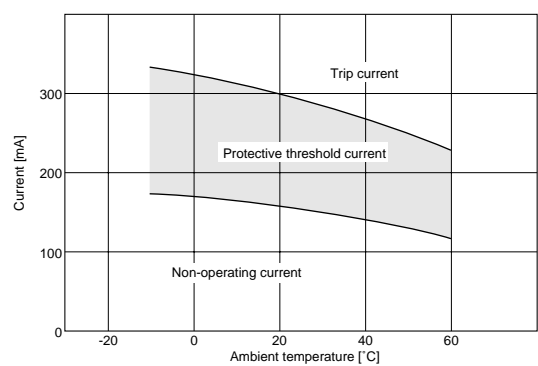

6

Continued from the preceding page.

■ Protective Threshold Current Range (265V Series)

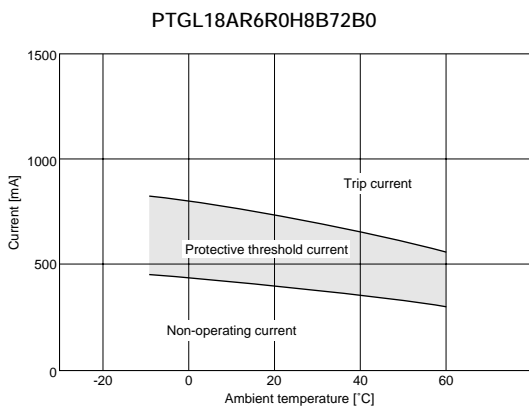
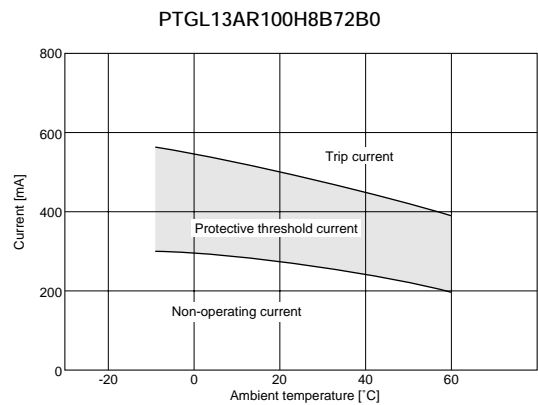
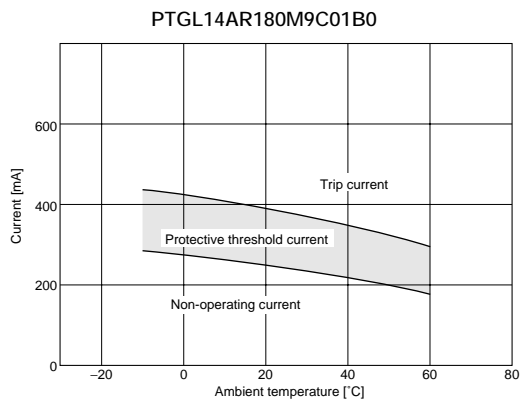
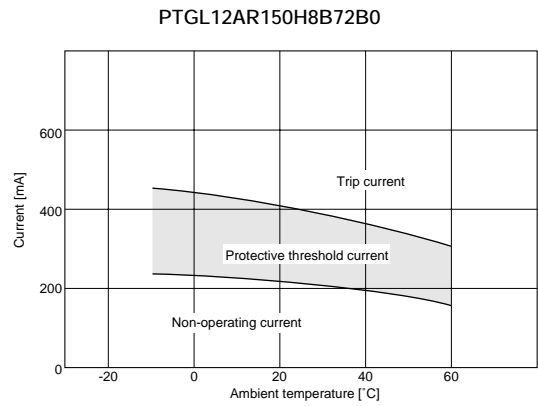
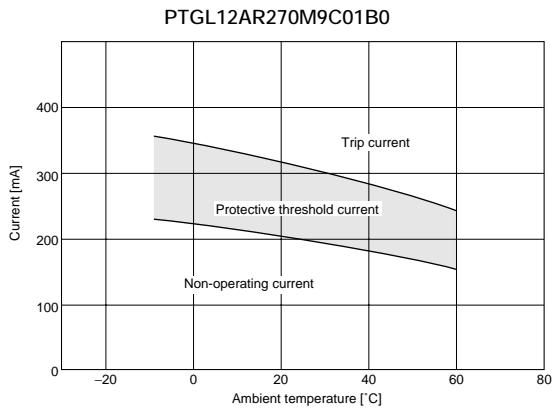

■ Operating Time 250V Series (Typical Curve)

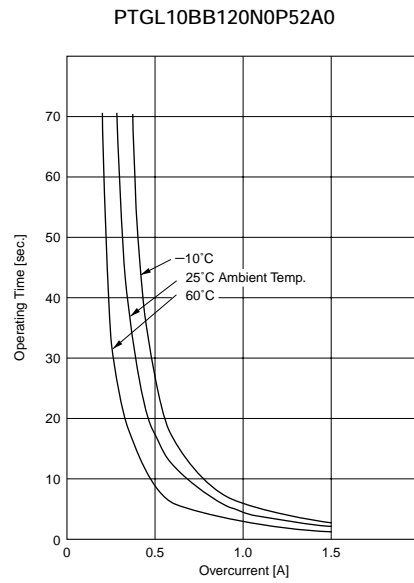
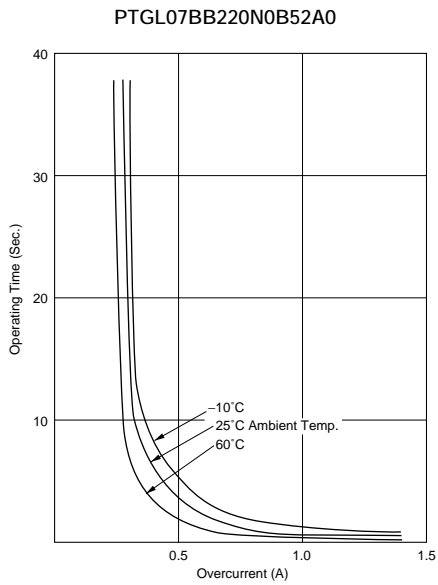

6

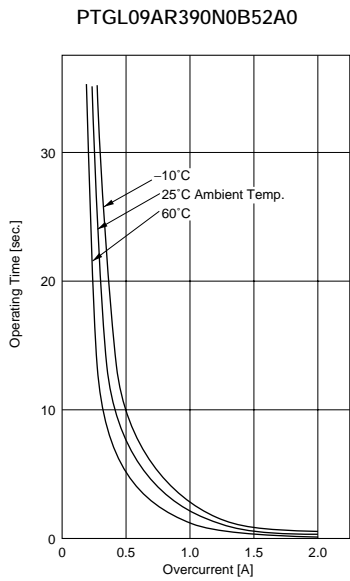

■ Operating Time 265V Series (Typical Curve)

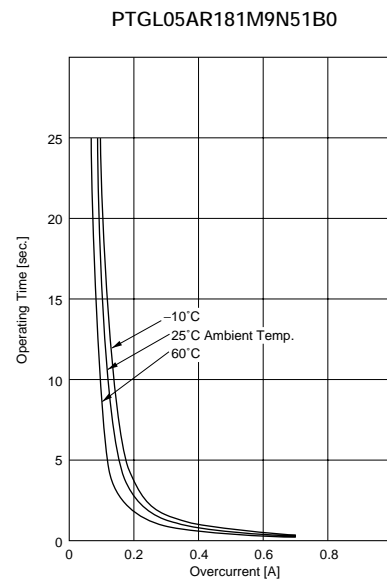
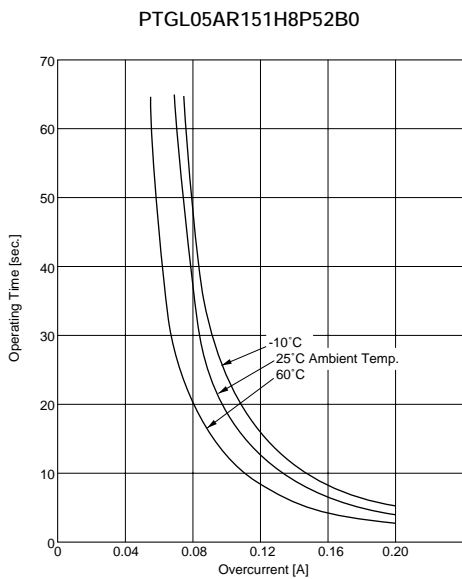

Continued from the preceding page.

■ Operating Time 265V Series (Typical Curve)

PTGL05AR121M9N51B0

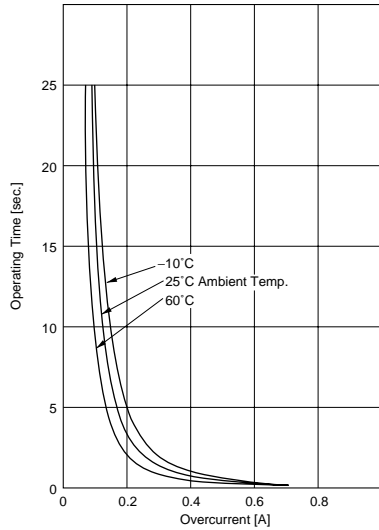

PTGL07AR820M9A51B0

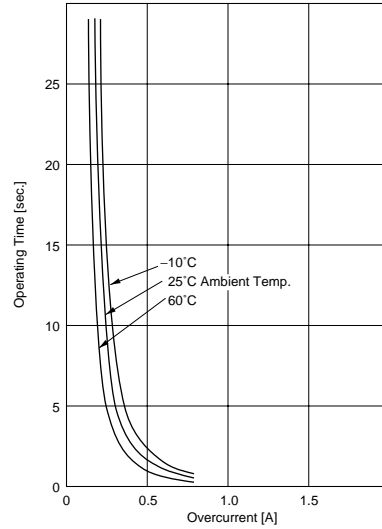

PTGL07AR700H8B52B0

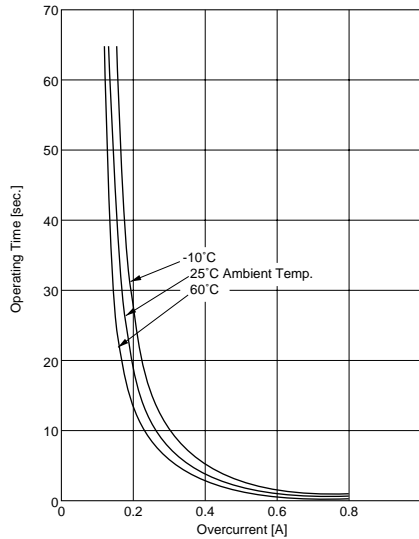

PTGL07AR650H8B52B0

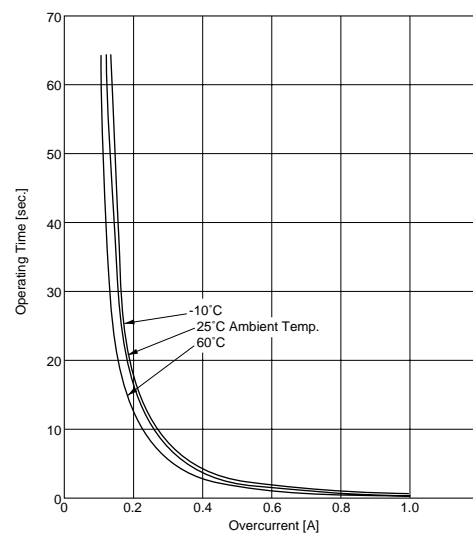

PTGL07AR450H8B52B0

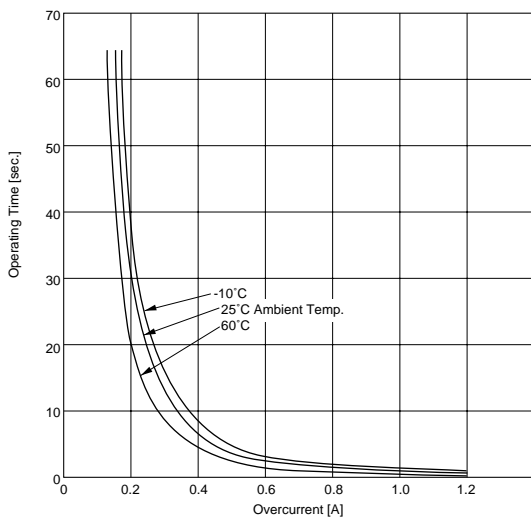

PTGL07AR560M9A51B0

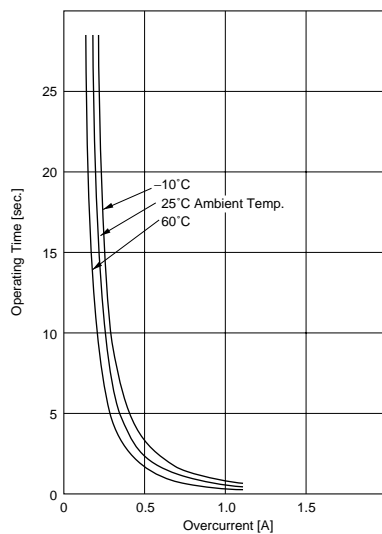

Continued on the following page. ↗

Continued from the preceding page.

Operating Time 265V Series (Typical Curve)

PTGL09AR390M9C61B0

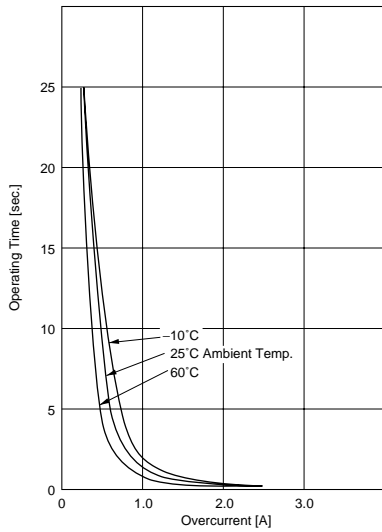

PTGL09AR250H8B52B0

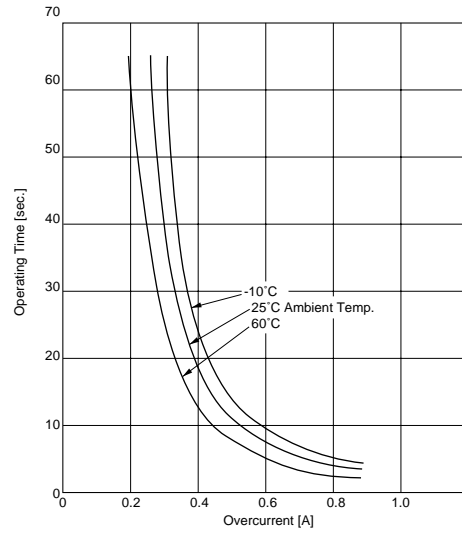

PTGL12AR270M9C01B0

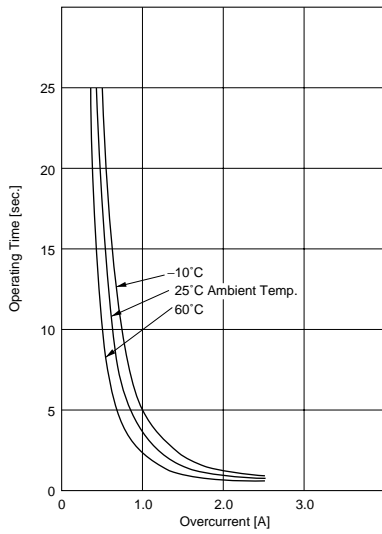

PTGL12AR150H8B72B0

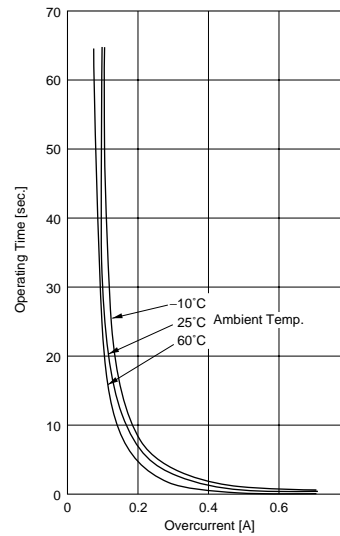

PTGL14AR180M9C01B0

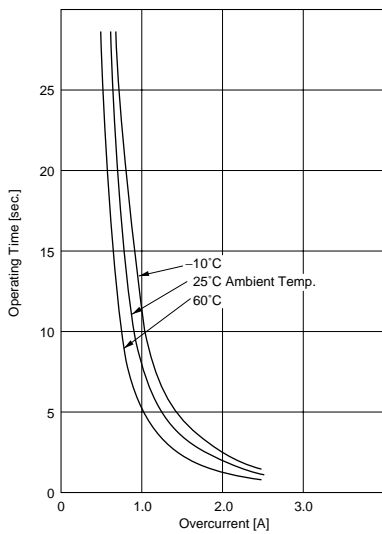

PTGL13AR100H8B72B0

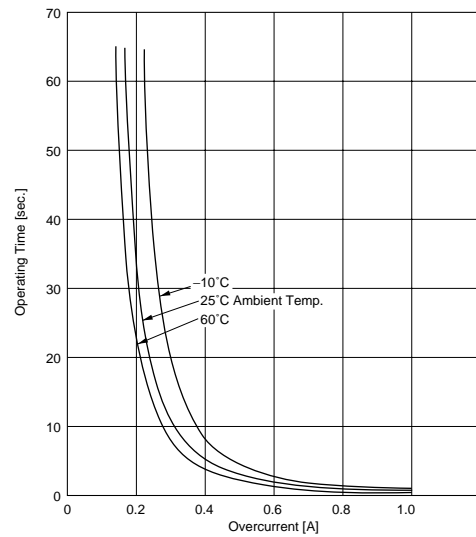

Continued from the preceding page.

### ■ Operating Time 265V Series (Typical Curve)

PTGL18AR6R0H8B72B0

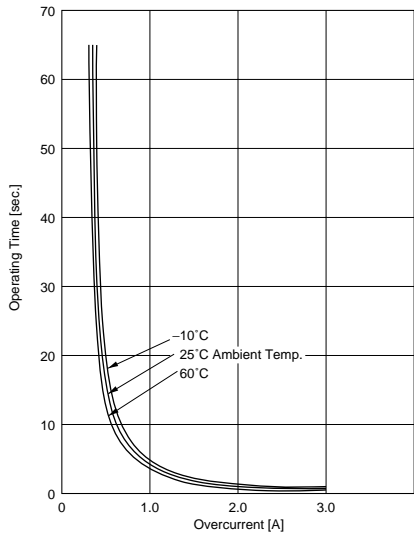

### ■ Application Circuit 250V Series

(1) Transistor Protection Circuit

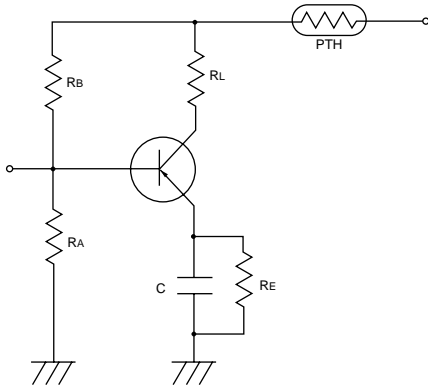

(2) Transformer Protection Circuit 1

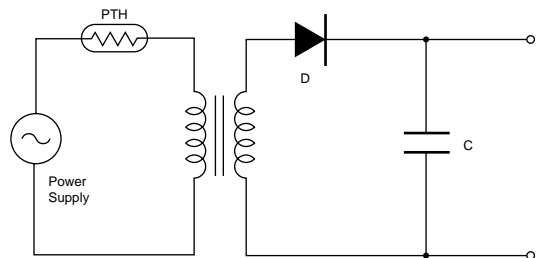

(3) Transformer Protection Circuit 2

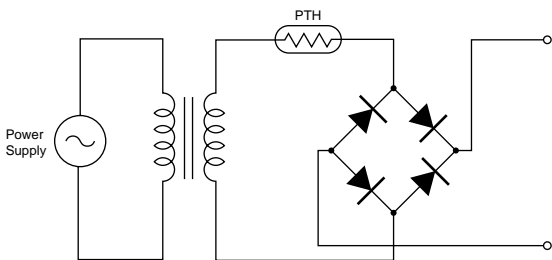

(4) Fluorescent Lamp Protection Circuit

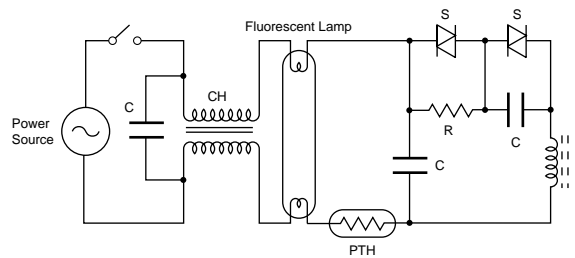

Continued on the following page. ↗



☞ Continued from the preceding page.

### ■ Application Circuit 250V Series

(5) Short-Circuit Test of IC

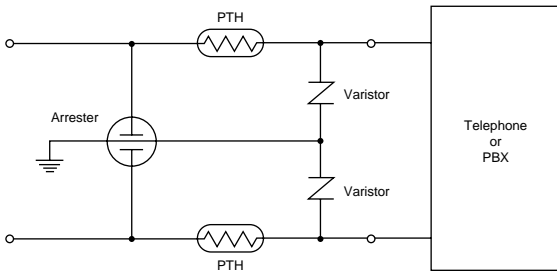

### ■ Application Circuit 265V Series

(1) Transformer Protection Circuit 1

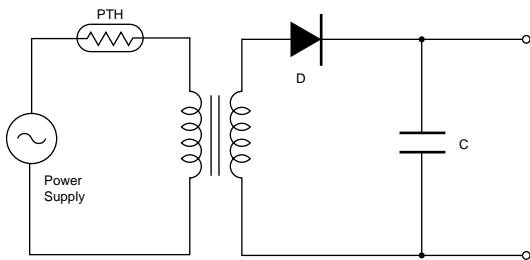

(2) Transformer Protection Circuit 2

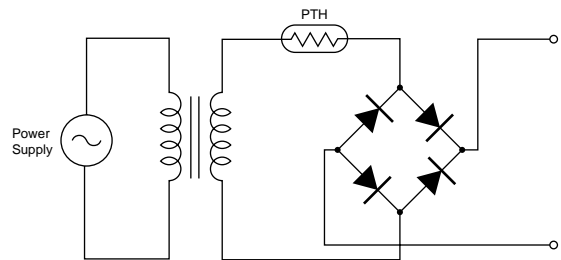

## PTGL Series Specifications and Test Methods

Item	Rating Value	Method of Examination						
Continuous Operating Temperature	-10 °C~+60 °C	The temperature range with maximum voltage applied to the POSISTOR®.						
Resistance Value (at 25°C)	Satisfies ratings	Resistance value is measured by applying voltage under 1.5Vdc (by a direct current of less than 10mA) at 25°C. (But it must be measured after maximum voltage is applied for 180 seconds and then is left for 2 hours at 25°C.) As for 16V series, measurement probe should be connected on the lead wire at the point within 2mm from the below side of the forming. Resistance should be measured 4 wing method.						
Withstanding Voltage	No problem	We apply AC voltage 120% that of the maximum voltage to POSISTOR® by raising voltage gradually for 180±5 seconds at 25°C. (A protective resistor is to be connected in series, and the inrush current through POSISTOR® must be limited below max. rated value.)						
Tensile Strength of Lead Wire Terminal	No damage	The load is gradually applied to each terminal of POSISTOR® until the force of the following table in the axial direction with fixing POSISTOR®'s body itself and this load is being kept for 10 seconds. <table border="1" style="margin-left: auto; margin-right: auto;"> <thead> <tr> <th>Lead Diameter</th> <th>Force</th> </tr> </thead> <tbody> <tr> <td>ø0.60mm max.</td> <td>4.90N</td> </tr> <tr> <td>ø0.65mm min.</td> <td>9.80N</td> </tr> </tbody> </table>	Lead Diameter	Force	ø0.60mm max.	4.90N	ø0.65mm min.	9.80N
Lead Diameter	Force							
ø0.60mm max.	4.90N							
ø0.65mm min.	9.80N							
Bending Strength of Lead Wire Terminal	Lead wire does not come off	POSISTOR® is held so that it is perpendicular to the lead wire with the following lead hanging in the axial direction of the lead wire. The lead wire is slowly bent toward 90° and returned. Then it is slowly bent in the opposite direction and returned to original state. <table border="1" style="margin-left: auto; margin-right: auto;"> <thead> <tr> <th>Lead Diameter</th> <th>Force</th> </tr> </thead> <tbody> <tr> <td>ø0.60mm max.</td> <td>2.45N</td> </tr> <tr> <td>ø0.65mm min.</td> <td>4.90N</td> </tr> </tbody> </table>	Lead Diameter	Force	ø0.60mm max.	2.45N	ø0.65mm min.	4.90N
Lead Diameter	Force							
ø0.60mm max.	2.45N							
ø0.65mm min.	4.90N							
Solderability	Solder is applied around the lead wire covering 3/4 or more of the circumference without gap in the axial direction.	The Lead wire of POSISTOR® is soaked in a Isopropyl alcohol (JIS K 8839) or ethanol (JIS K 8101) solution (about 25wt%) of colophony (JIS K 5902) for 5 to 10 sec. And, each lead wire is soaked in Molten solder (JIS Z 3282 H60A) at 235±5°C from the bottom to a point of 2.0 to 2.5mm for 2±0.5 sec.						
Terminal Durability of Soldering	$\Delta R/R \leq \pm 15\%$	The lead wire of POSISTOR® is soaked in Molten solder (JIS Z 3282 H60A) at 350±10°C from the bottom to a point of 2.0 to 2.5mm for 3.5±0.5 sec. And, after the device is being left at room temperature (25°C) for 24±4 hours, the resistance is measured.						
Humidity Test	$\Delta R/R \leq \pm 20\%$	POSISTOR® is set in an environmental chamber at 40±2°C and 90 to 95% humidity for 500±4 hours. And after the device is being left at room temperature (25°C) for one hour, the resistance measurement is performed.						
Load Cycle Test at High Temperature	$\Delta R/R \leq \pm 20\%$	POSISTOR® is set in an environmental chamber at 60±3°C with maximum voltage applied for 1.5 hours and then is left without voltage applied for 0.5 hours. This cycle is repeated for 1000±10 hours, and after the device is left at room temperature (25°C) for one hour, the resistance measurement is performed. (A protective resistor is to be connected in series and the inrush current through POSISTOR® must be limited below max. rated value.)						