



26.5 x 32.0 x 35.5 mm

## Features

- Maxi ISO Sized Automotive Relay
- Internal Blowout Magnets
- Capable of Switching up to 145VDC
- Suitable for DC Motor and Lamp Control
- PCB Pin and Quick Connect Mounting Options



## Contact Data\*

Contact Arrangement	1A = SPST N.O. 1C = SPDT
Contact Rating	80A @ 14VDC, resistive 60A @ 36VDC, resistive 50A @ 48VDC, resistive 30A @ 72VDC, resistive 15A @ 90VDC, resistive 5A @ 145VDC, resistive

Contact Resistance	< 50 milliohms initial
Contact Material	AgSnO <sub>2</sub>
Maximum Switching Voltage	145VDC
Maximum Switching Current	Make : 150A@14VDC for 3 seconds Break : 80A

## Coil Data\*

Coil Voltage VDC		Coil Resistance Ω +/- 10%	Pick Up Voltage VDC (max)  70% of rated voltage	Release Voltage VDC (min)  10% of rated voltage	Coil Power W	Operate Time ms	Release Time ms
Rated	Max						
12	15.6	1.6W	7.8	1.2	1.6W	15	15
24	31.2	360	15.6	2.4			

## General Data\*

Electrical Life @ rated load	100K cycles, average	
Mechanical Life	500K cycles, average	
Insulation Resistance	1000M Ω min. @ 500VDC initial	
Dielectric Strength	Coil to Contact	750V rms min. @ sea level initial
	Contact to Contact	500V rms min. @ sea level initial
Shock Resistance	Functional	42m/s <sup>2</sup> (4.4G)
	Destructive	288m/s <sup>2</sup> (30G)
Vibration Resistance	0.5mm 10~500Hz double amplitude (10G)	
Operating Temperature	-40°C to +125°C (above 85°C, consult factory)	
Storage Temperature	-40°C to +155°C	
Solderability	260°C for 5 s	
Weight	80g	

\* Values can change due to the switching frequency, desired reliability levels, environmental conditions and in-rush load levels. It is recommended to test actual load conditions for the application. It is the user's responsibility to determine the performance suitability for their specific application. The use of any coil voltage less than the rated coil voltage may compromise the operation of the relay.



## Ordering Information

1. Series	A3K	1A	S	Q	12VDC	1.6	R
A3K standard A3KM with metal bracket							
2. Contact Arrangement 1A = SPST N.O. 1C = SPDT							
3. Sealing Option S = Sealed C = Dust Cover							
4. Termination P = PCB Pins Q = Quick Connect							
5. Coil Voltage 12VDC 24VDC							
6. Coil Power 1.6 = 1.6W							
7. Coil Suppression Blank = Standard D = Diode (1N4007) Cathode on "86" terminal R = Resistor (680Ω for 12VDC; 2700Ω for 24VDC) ** Consult factory if other values are needed							

## Dimensions

Units = mm

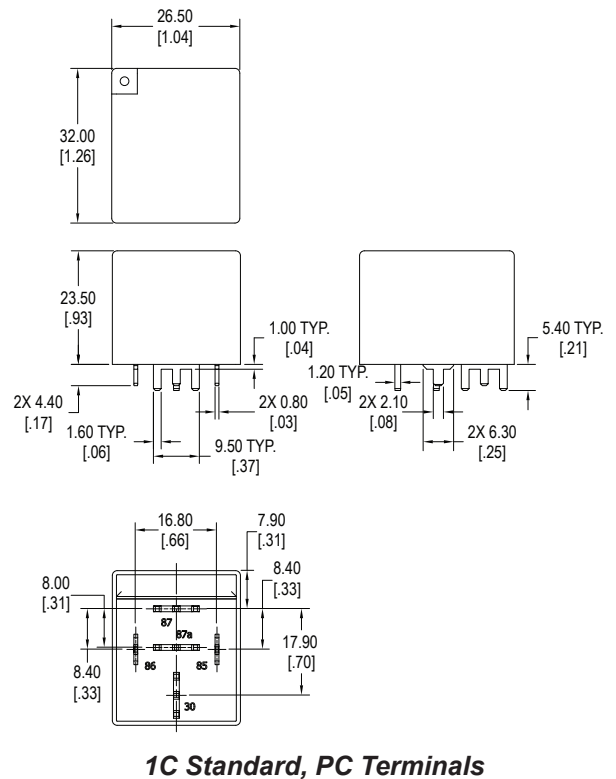
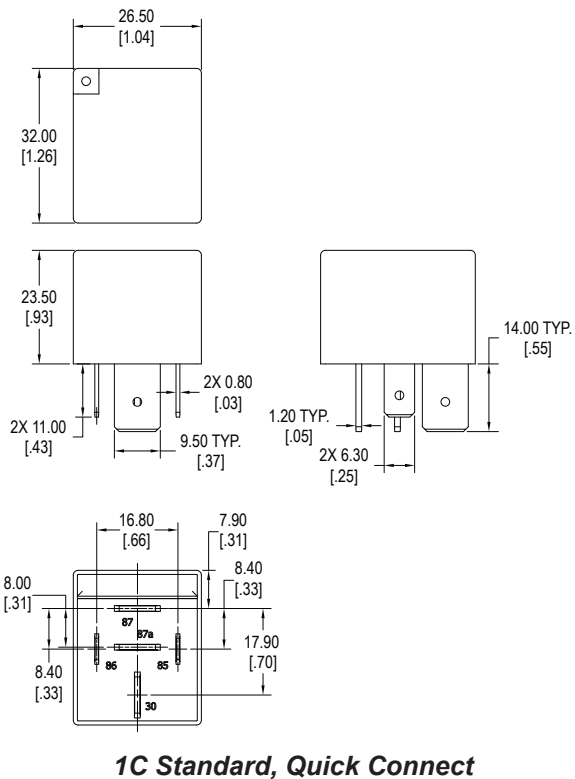



## Dimensions

Units = mm

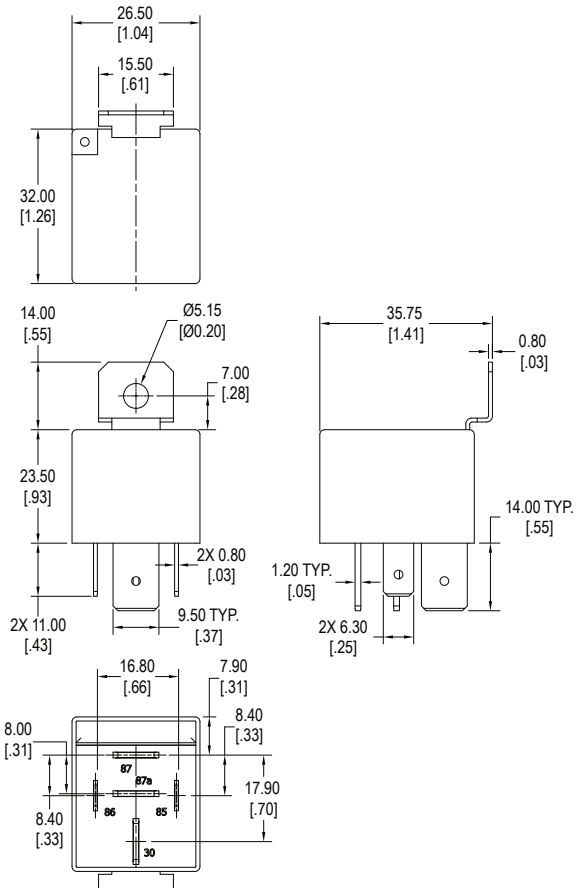

**1C Metal Bracket, Quick Connect**

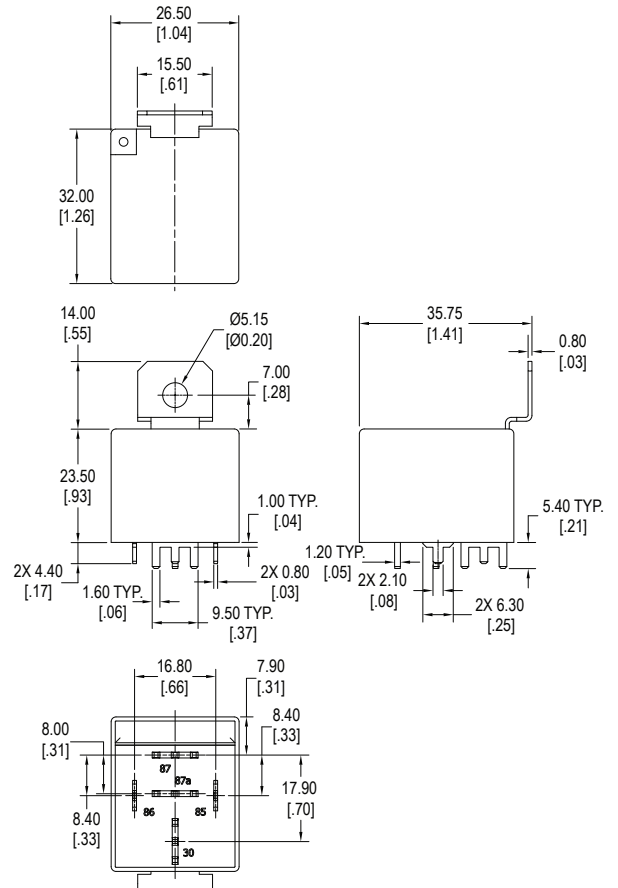

**1C Metal Bracket, PC Terminals**



## Schematics & PC Layouts

### Bottom Views

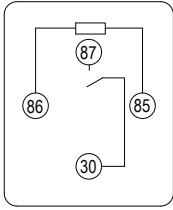

**1A**

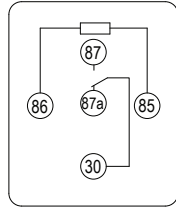

**1C**

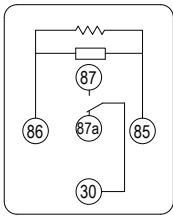

**1C with Resistor**

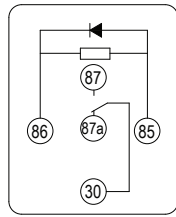

**1C with Diode**

