

Features

- Epitaxial Planar Die Construction
- Complementary NPN Type Available (MMSTA05/MMSTA06)
- Ideal for Low Power Amplification and Switching
- Ultra-Small Surface Mount Package
- **Lead Free/RoHS Compliant (Note 2)**
- **"Green" Device (Note 3 and 4)**

Mechanical Data

- Case: SOT-323
- Case Material: Molded Plastic, "Green" Molding Compound, Note 4. UL Flammability Classification Rating 94V-0
- Moisture Sensitivity: Level 1 per J-STD-020C
- Terminal Connections: See Diagram
- Terminals: Solderable per MIL-STD-202, Method 208
- Lead Free Plating (Matte Tin Finish annealed over Alloy 42 leadframe).
- MMSTA55 Marking K2H, K2G (See Page 3)
- MMSTA56 Marking K2G (See Page 3)
- Ordering & Date Code Information: See Page 3
- Weight: 0.006 grams (approximate)

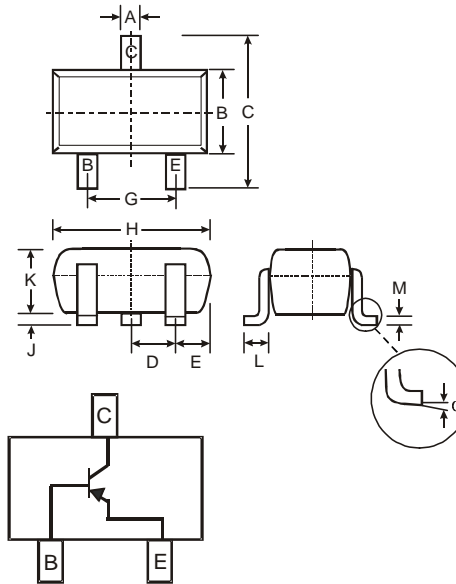

| SOT-323 | | |
|----------------------|--------------|------|
| Dim | Min | Max |
| A | 0.25 | 0.40 |
| B | 1.15 | 1.35 |
| C | 2.00 | 2.20 |
| D | 0.65 Nominal | |
| E | 0.30 | 0.40 |
| G | 1.20 | 1.40 |
| H | 1.80 | 2.20 |
| J | 0.0 | 0.10 |
| K | 0.90 | 1.00 |
| L | 0.25 | 0.40 |
| M | 0.10 | 0.18 |
| α | 0° | 8° |
| All Dimensions in mm | | |

Maximum Ratings @T_A = 25°C unless otherwise specified

| Characteristic | Symbol | MMSTA55 | MMSTA56 | Unit |
|--|-----------------------------------|-------------|---------|------|
| Collector-Base Voltage | V _{CB0} | -60 | -80 | V |
| Collector-Emitter Voltage | V _{CEO} | -60 | -80 | V |
| Emitter-Base Voltage | V _{EBO} | -4.0 | | V |
| Collector Current - Continuous (Note 1) | I _C | -500 | | mA |
| Power Dissipation (Note 1) | P _d | 200 | | mW |
| Thermal Resistance, Junction to Ambient (Note 1) | R _{θJA} | 625 | | °C/W |
| Operating and Storage Temperature Range | T _i , T _{STG} | -55 to +150 | | °C |

- Notes:
1. Device mounted on FR-4 PCB, 1 inch x 0.85 inch x 0.062 inch; pad layout as shown on Diodes Inc. suggested pad layout document AP02001, which can be found on our website at <http://www.diodes.com/datasheets/ap02001.pdf>.
 2. No purposefully added lead.
 3. Diodes Inc.'s "Green" policy can be found on our website at http://www.diodes.com/products/lead_free/index.php.
 4. Product manufactured with Date Code 0627 (week 27, 2006) and newer are built with Green Molding Compound. Product manufactured prior to Date Code 0627 are built with Non-Green Molding Compound and may contain Halogens or Sb2O3 Fire Retardants.

Electrical Characteristics @T_A = 25°C unless otherwise specified

| Characteristic | Symbol | Min | Max | Unit | Test Condition | |
|--------------------------------------|--------------------|----------------------|------------|-------|----------------|---|
| OFF CHARACTERISTICS (Note 5) | | | | | | |
| Collector-Base Breakdown Voltage | MMSTA55 MMSTA56 | V _{(BR)CBO} | -60 -80 | — | V | I _C = -100μA, I _E = 0 |
| Collector-Emitter Breakdown Voltage | MMSTA55 MMSTA56 | V _{(BR)CEO} | -60 -80 | — | V | I _C = -1.0mA, I _B = 0 |
| Emitter-Base Breakdown Voltage | | V _{(BR)EBO} | -4.0 | — | V | I _E = -100μA, I _C = 0 |
| Collector Cutoff Current | MMSTA55 MMSTA56 | I _{CBO} | — | -100 | nA | V _{CB} = -60V, I _E = 0 V _{CB} = -80V, I _E = 0 |
| Collector Cutoff Current | MMSTA55 MMSTA56 | I _{CEx} | — | -100 | nA | V _{CE} = -60V, I _{BO} = 0V V _{CE} = -80V, I _{BO} = 0V |
| ON CHARACTERISTICS (Note 5) | | | | | | |
| DC Current Gain | | h _{FE} | 100 | — | — | I _C = -10mA, V _{CE} = -1.0V I _C = -100mA, V _{CE} = -1.0V |
| Collector-Emitter Saturation Voltage | | V _{CE(SAT)} | — | -0.25 | V | I _C = -100mA, I _B = -10mA |
| Base-Emitter Saturation Voltage | | V _{BE(SAT)} | — | -1.2 | V | I _C = -100mA, V _{CE} = -1.0V |
| SMALL SIGNAL CHARACTERISTICS | | | | | | |
| Current Gain-Bandwidth Product | | f _T | 50 | — | MHz | V _{CE} = -1.0V, I _C = -100mA, f = 100MHz |

Notes: 5. Short duration pulse test used to minimize self-heating effect.

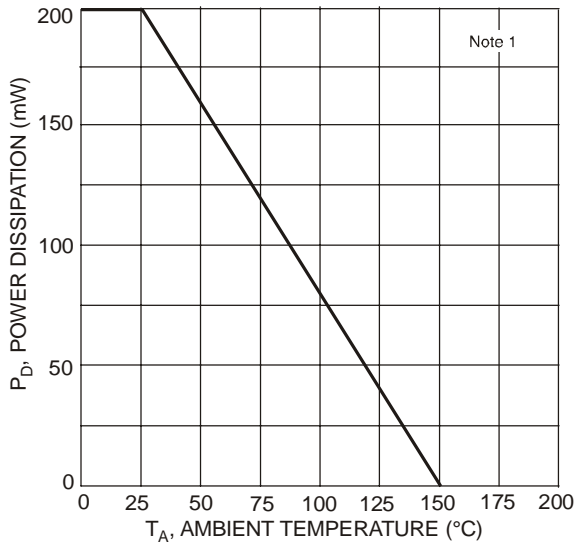

Fig. 1, Max Power Dissipation vs. Ambient Temperature

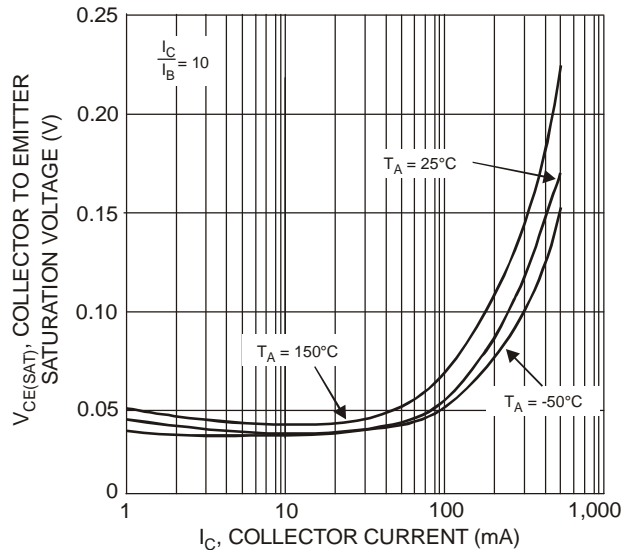

Fig. 2, Collector Emitter Saturation Voltage vs. Collector Current

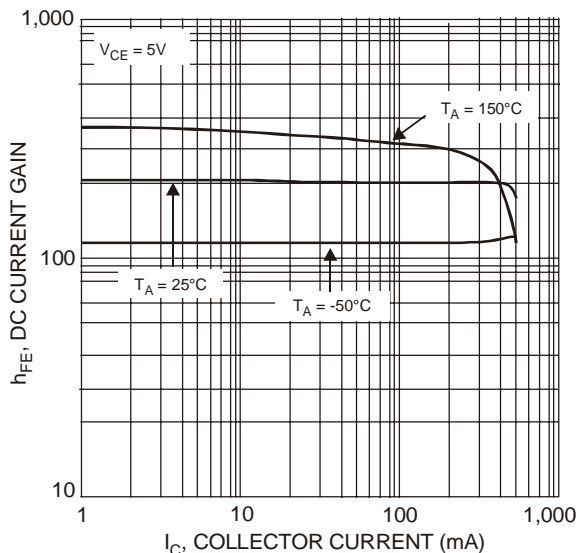

Fig. 3, DC Current Gain vs. Collector Current

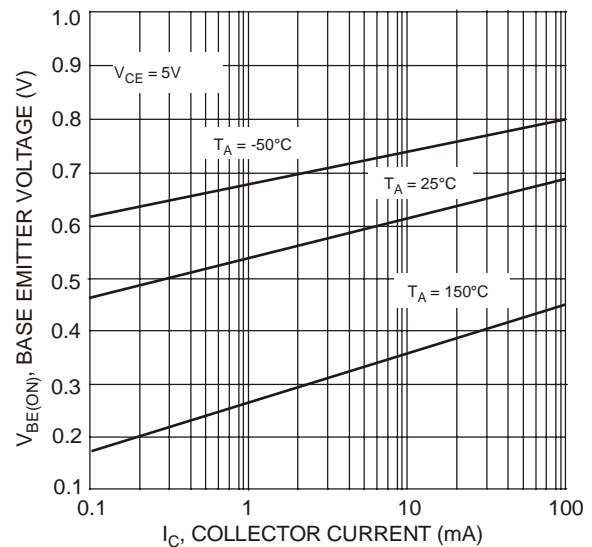

Fig. 4 Base Emitter Voltage vs. Collector Current

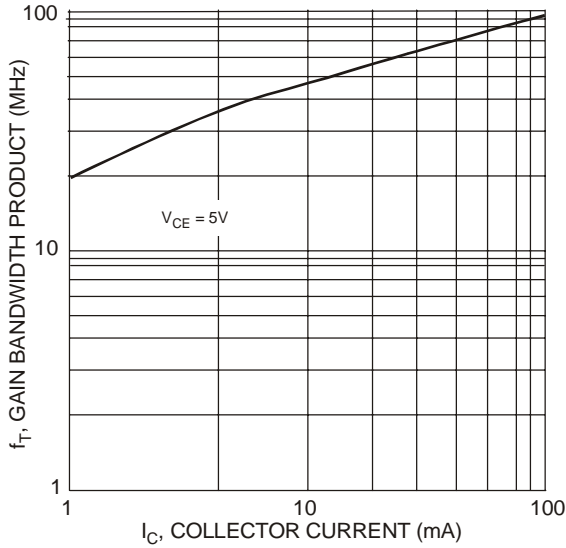

Fig. 5 Gain Bandwidth Product vs. Collector Current

Ordering Information (Notes 4 and 6)

| Device | Packaging | Shipping |
|-------------|-----------|------------------|
| MMSTA55-7-F | SOT-323 | 3000/Tape & Reel |
| MMSTA56-7-F | SOT-323 | 3000/Tape & Reel |

Notes: 6. For packaging details, go to our website at <http://www.diodes.com/datasheets/ap02007.pdf>.

Marking Information

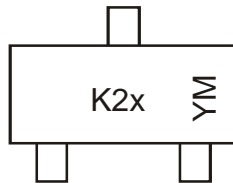

K2x = Product Type Marking Code, e.g. K2H = MMSTA55
 YM = Date Code Marking
 Y = Year ex: N = 2002
 M = Month ex: 9 = September

Date Code Key

| Year | 1998 | 1999 | 2000 | 2001 | 2002 | 2003 | 2004 | 2005 | 2006 | 2007 | 2008 | 2009 | 2010 | 2011 | 2012 |
|------|------|------|------|------|------|------|------|------|------|------|------|------|------|------|------|
| Code | J | K | L | M | N | P | R | S | T | U | V | W | X | Y | Z |

| Month | Jan | Feb | Mar | Apr | May | Jun | Jul | Aug | Sep | Oct | Nov | Dec |
|-------|-----|-----|-----|-----|-----|-----|-----|-----|-----|-----|-----|-----|
| Code | 1 | 2 | 3 | 4 | 5 | 6 | 7 | 8 | 9 | O | N | D |

IMPORTANT NOTICE

Diodes Incorporated and its subsidiaries reserve the right to make modifications, enhancements, improvements, corrections or other changes without further notice to any product herein. Diodes Incorporated does not assume any liability arising out of the application or use of any product described herein; neither does it convey any license under its patent rights, nor the rights of others. The user of products in such applications shall assume all risks of such use and will agree to hold Diodes Incorporated and all the companies whose products are represented on our website, harmless against all damages.

LIFE SUPPORT

Diodes Incorporated products are not authorized for use as critical components in life support devices or systems without the expressed written approval of the President of Diodes Incorporated.