

EVALUATION KIT  
AVAILABLE

# MAXIM

## 3.5GHz Downconverter Mixers with Selectable LO Doubler

MAX2683/MAX2684

### General Description

The MAX2683/MAX2684 are super-high-performance, low-cost downconverter mixers intended for wireless local loop (WLL) and digital microwave radio (DMR) applications in the 3.4GHz to 3.8GHz frequency band. The MAX2683 is optimized for downconversion to IF frequencies between 100MHz and 400MHz, and allows both high-side and low-side local oscillator (LO) injection. The MAX2684 is optimized for IF frequencies between 800MHz and 1000MHz, and allows low-side LO injection. A logic-level control enables an internal frequency doubler on both devices, allowing the external LO source to run at full or half frequency. An internal LO filter reduces LO harmonics and spurious mixing.

The MAX2683/MAX2684 feature an externally adjustable bias control, set with a single resistor, that lets the user trade supply current for linearity to optimize system performance. These devices use a double-balanced Gilbert-cell architecture with single-ended RF and LO inputs and differential open-collector IF output ports. Differential IF ports provide a wideband, flexible interface for either single-ended or differential applications.

The MAX2683/MAX2684 operate from a single +2.7V to +5.5V supply. The devices are packaged in an ultra-small 16-pin TSSOP-EP package with an exposed paddle for optimum performance at 3.5GHz.

### Applications

Wireless Local Loop (WLL)  
Digital Microwave Radio (DMR)  
Wireless Broadband Access

### Functional Diagram

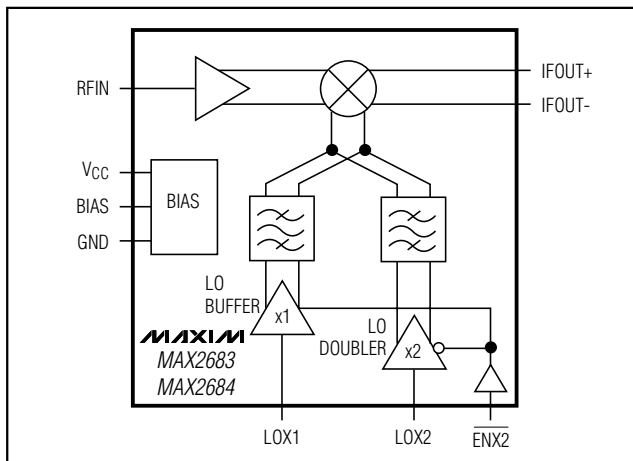

### Features

- ◆ 3.4GHz to 3.8GHz RF Frequency Range
- ◆ 100MHz to 400MHz IF Frequency Range (MAX2683)  
800MHz to 1000MHz IF Frequency Range (MAX2684)
- ◆ Logic-Enabled LO Frequency Doubler
- ◆ Conversion Gain  
+6.7dB (MAX2683)  
+1dB (MAX2684)
- ◆ Programmable IIP3  
+7dBm to +11dBm (MAX2683)  
+8dBm to +12dBm (MAX2684)
- ◆ +2.7V to +5.5V Single-Supply Operation
- ◆ Ultra-Small 16-Pin TSSOP-EP Package

### Ordering Information

PART	TEMP RANGE	PIN-PACKAGE
MAX2683EUE	-40°C to +85°C	16 TSSOP-EP*
MAX2684EUE	-40°C to +85°C	16 TSSOP-EP*

\*Exposed pad

Typical Operating Circuit appears at end of data sheet.

### Pin Configuration

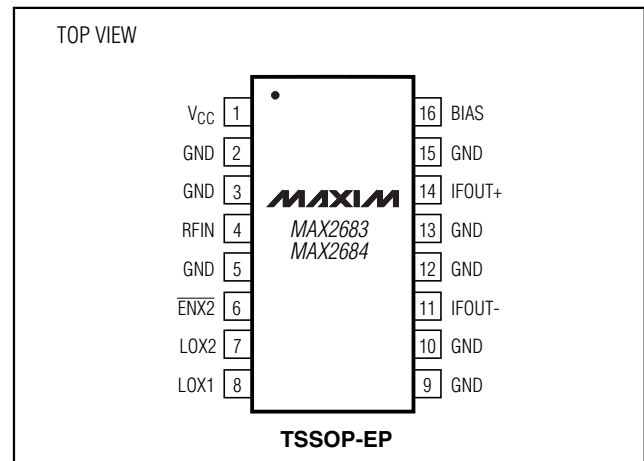

MAXIM

Maxim Integrated Products 1

For pricing, delivery, and ordering information, please contact Maxim/Dallas Direct! at 1-888-629-4642, or visit Maxim's website at [www.maxim-ic.com](http://www.maxim-ic.com).

# 3.5GHz Downconverter Mixers with Selectable LO Doubler

## ABSOLUTE MAXIMUM RATINGS

V <sub>CC</sub> to GND .....	-0.3V to +6.0V	Operating Temperature Range .....	-40°C to +85°C
IFOUT+, IFOUT-, ENX2, BIAS to GND .....	-0.3V to (V <sub>CC</sub> + 0.3V)	Junction Temperature .....	+150°C
RFIN Input Power (50Ω source) .....	+10dBm	Storage Temperature Range .....	-65°C to +150°C
LO Input Power (50Ω source) .....	+10dBm	Lead Temperature (soldering, 10s) .....	+300°C
RBIAS .....	820Ω min		
Continuous Power Dissipation (T <sub>A</sub> = +70°C)			
16-Pin TSSOP-EP (derate 21.3mW/°C			
above +70°C) .....	1702mW		

Stresses beyond those listed under "Absolute Maximum Ratings" may cause permanent damage to the device. These are stress ratings only, and functional operation of the device at these or any other conditions beyond those indicated in the operational sections of the specifications is not implied. Exposure to absolute maximum rating conditions for extended periods may affect device reliability.

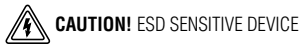

## DC ELECTRICAL CHARACTERISTICS

(V<sub>CC</sub> = +2.7V to +5.5V; R<sub>BIAS</sub> = 1.2kΩ; ENX2 = GND; RFIN, LOX1, and LOX2 are terminated in 50Ω, no input signal applied; IFOUT+ = IFOUT- = V<sub>CC</sub>, T<sub>A</sub> = -40°C to +85°C, unless otherwise noted. Typical values are at V<sub>CC</sub> = +5V, T<sub>A</sub> = +25°C.) (Note 1)

PARAMETER	CONDITIONS	MIN	TYP	MAX	UNITS
Supply Current			55	66	mA
Supply Current Reduction when LO Doubler is Disabled	ENX2 = V <sub>CC</sub>		15		mA
Input Logic Voltage High		2.0			V
Input Logic Voltage Low				0.6	V
Input Logic Bias Current		-20		10	μA

## AC ELECTRICAL CHARACTERISTICS—MAX2683

(MAX2683/MAX2684 EV kit, V<sub>CC</sub> = +5V, R<sub>BIAS</sub> = 1.2kΩ, ENX2 = GND, f<sub>RF</sub> = 3.6GHz, P<sub>RF</sub> = -20dBm, f<sub>LOX2</sub> = 1650MHz, P<sub>LO</sub> = -5dBm, all input/output ports terminated in 50Ω, IFOUT+ and IFOUT- matched to single-ended 50Ω load, T<sub>A</sub> = +25°C, unless otherwise noted.)

PARAMETER	CONDITIONS	MIN	TYP	MAX	UNITS
RF Frequency Range	(Notes 2, 3)	3.4		3.8	GHz
IF Frequency Range	(Notes 2, 3)	100		400	MHz
LOX2 Frequency Range	ENX2 = GND (Notes 2, 3)	1.5		1.95	GHz
LOX1 Frequency Range	ENX2 = V <sub>CC</sub> (Notes 2, 3)	3.0		3.9	GHz
Conversion Gain	(Notes 1, 4)	4.8	6.7	8.0	dB
Gain Variation Over Temperature	T <sub>A</sub> = -40°C to +85°C (Note 2)		±0.5	±1.2	dB
Input 1dB Compression Point			+0.8		dBm
Input Third-Order Intercept Point	(Note 5)		+8.8		dBm
Input Second-Order Intercept Point	(Note 6)		+33		dBm
Noise Figure	(Note 7)		12		dB
RFIN Input Return Loss	(Note 8)		-18		dB
LOX2 Leakage at RFIN	ENX2 = GND	f <sub>RFIN</sub> = 1 × f <sub>LO</sub>		-42	dBm
		f <sub>RFIN</sub> = 2 × f <sub>LO</sub>		-38	
		f <sub>RFIN</sub> = 3 × f <sub>LO</sub>		-49	
LOX1 Leakage at RFIN	ENX2 = V <sub>CC</sub> , f <sub>RFIN</sub> = 1 × f <sub>LO</sub> , f <sub>LOX1</sub> = 3.3GHz		-39		dBm

# 3.5GHz Downconverter Mixers with Selectable LO Doubler

MAX2683/MAX2684

## AC ELECTRICAL CHARACTERISTICS—MAX2683 (continued)

(MAX2683/MAX2684 EV kit,  $V_{CC} = +5V$ ,  $R_{BIAS} = 1.2k\Omega$ ,  $\overline{ENX2} = GND$ ,  $f_{RF} = 3.6GHz$ ,  $P_{RF} = -20dBm$ ,  $f_{LOX2} = 1650MHz$ ,  $P_{LO} = -5dBm$ , all input/output ports terminated in  $50\Omega$ , IFOUT+ and IFOUT- matched to single-ended  $50\Omega$  load,  $T_A = +25^\circ C$ , unless otherwise noted.)

PARAMETER	CONDITIONS	MIN	TYP	MAX	UNITS
LOX2 Leakage at IFOUT+, IFOUT-	$\overline{ENX2} = GND$	$f_{IFOUT} = 1 \times f_{LO}$		-39	dBm
		$f_{IFOUT} = 2 \times f_{LO}$		-39	
		$f_{IFOUT} = 3 \times f_{LO}$		-64	
LOX1 Leakage at IFOUT+, IFOUT-	$\overline{ENX2} = V_{CC}$ , $f_{IFOUT} = 1 \times f_{LO}$ , $f_{LOX1} = 3.3GHz$		-39		dBm
LOX1, LOX2 Input Return Loss	(Note 9)		-20		dB

## AC ELECTRICAL CHARACTERISTICS—MAX2684

(MAX2683/MAX2684 EV kit,  $V_{CC} = +5V$ ,  $R_{BIAS} = 1.2k\Omega$ ,  $\overline{ENX2} = GND$ ,  $f_{RF} = 3.6GHz$ ,  $P_{RF} = -20dBm$ ,  $f_{LOX2} = 1350MHz$ ,  $P_{LO} = -5dBm$ , all input/output ports terminated in  $50\Omega$ , IFOUT+ and IFOUT- matched to single-ended  $50\Omega$  load,  $T_A = +25^\circ C$ , unless otherwise noted.)

PARAMETER	CONDITIONS	MIN	TYP	MAX	UNITS
RF Frequency Range	(Notes 2, 3)	3.4		3.8	GHz
IF Frequency Range	(Notes 2, 3)	800		1000	MHz
LOX2 Frequency Range	$\overline{LOX2} = GND$ (Notes 2, 3)	1.2		1.45	GHz
LOX1 Frequency Range	$\overline{LOX2} = V_{CC}$ (Notes 2, 3)	2.4		2.9	GHz
Conversion Gain	(Notes 1, 4)	-0.8	+1	+2.3	dB
Gain Variation Over Temperature and Frequency	$T_A = -40^\circ C$ to $+85^\circ C$		$\pm 0.5$	$\pm 1.2$	dB
Input 1dB Compression Point			0		dBm
Input Third-Order Intercept Point	(Note 10)		+9.5		dBm
Input Second-Order Intercept Point	(Note 11)		+37		dBm
Noise Figure	(Note 7)		13.6		dB
RFIN Input Return Loss	(Note 8)		-18		dB
LOX2 Leakage at RFIN	$\overline{ENX2} = GND$	$f_{RFIN} = 1 \times f_{LOX2}$		-47	dBm
		$f_{RFIN} = 2 \times f_{LOX2}$		-43	
		$f_{RFIN} = 3 \times f_{LOX2}$		-49	
LOX1 Leakage at RFIN	$\overline{ENX2} = V_{CC}$ , $f_{RFIN} = 1 \times f_{LOX1}$ , $f_{LOX1} = 2.7GHz$		-45		dBm
LOX2 Leakage at IFOUT+, IFOUT-	$\overline{ENX2} = GND$	$f_{RFIN} = 1 \times f_{LOX2}$		-37	dBm
		$f_{RFIN} = 2 \times f_{LOX2}$		-20	
		$f_{RFIN} = 3 \times f_{LOX2}$		-41	
LOX1 Leakage at IFOUT+, IFOUT-	$\overline{ENX2} = V_{CC}$ , $f_{IFOUT} = 1 \times f_{LOX1}$ , $f_{LOX1} = 2.7GHz$		-15		dBm
LOX1, LOX2 Input Return Loss	(Note 9)		-20		dB

**Note 1:** Limits over temperature are guaranteed by production test at  $+25^\circ C$  and via correlation to worst-case temperature testing.

**Note 2:** Minimum and maximum limits are guaranteed by design and characterization, but are not production tested.

**Note 3:** The device has been characterized over the specified frequency range. Operation outside of this range is possible but not guaranteed.

# 3.5GHz Downconverter Mixers with Selectable LO Doubler

- Note 4:** Conversion gain does not include output balun losses, typically 0.3dB at 300MHz on the MAX2683 EV kit and 0.8dB at 900MHz on the MAX2684 EV kit.
- Note 5:** IIP3 measured with two tones at 3605MHz and 3610MHz, -20dBm per tone,  $f_{IF} = 300\text{MHz}$ .
- Note 6:** IIP2 measured with  $f_{RFIN} = 3450\text{MHz}$ ,  $P_{RFIN} = -20\text{dBm}$ ,  $f_{IF} = 300\text{MHz}$ .
- Note 7:** Input match optimized for best return loss at  $f_{RF} = 3600\text{MHz}$ .
- Note 8:** Over specified RF input frequency range with matching network.
- Note 9:** Over specified LO input frequency range.
- Note 10:** IIP3 measured with two tones at 3605MHz and 3610MHz, -20dBm per tone,  $f_{IF} = 900\text{MHz}$ .
- Note 11:** IIP2 measured with  $f_{RFIN} = 3150\text{MHz}$ ,  $P_{RFIN} = -20\text{dBm}$ ,  $f_{IF} = 900\text{MHz}$ .

## Typical Operating Characteristics

(MAX2683/MAX2684 EV kit,  $V_{CC} = +5\text{V}$ ,  $R_{BIAS} = 1.2\text{k}\Omega$ ,  $\overline{ENX2} = \text{GND}$ ,  $f_{RF} = 3.6\text{GHz}$ ,  $P_{RF} = -20\text{dBm}$ ,  $f_{LOX2} = 1650\text{MHz}$  for MAX2683 or  $f_{LOX2} = 1350\text{MHz}$  for MAX2684,  $P_{LO} = -5\text{dBm}$ , all input/output ports terminated in  $50\Omega$ , IFOUT+ and IFOUT- matched to single-ended  $50\Omega$  load,  $T_A = +25^\circ\text{C}$ , unless otherwise noted.)

### MAX2683

**SUPPLY CURRENT vs. SUPPLY VOLTAGE**  
( $\overline{ENX2} = \text{GND}$ )

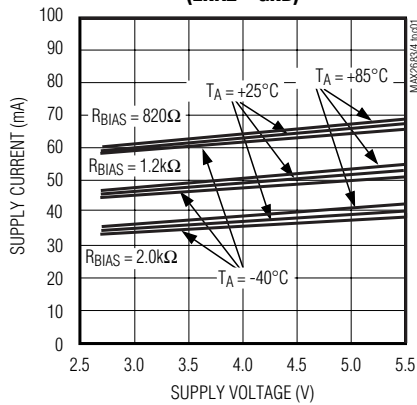

**SUPPLY CURRENT vs. SUPPLY VOLTAGE**  
( $\overline{ENX2} = V_{CC}$ )

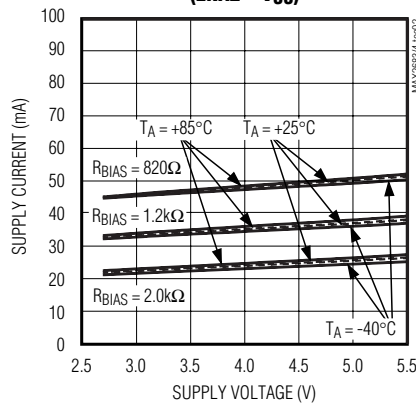

**SUPPLY CURRENT vs. R\_BIAS**

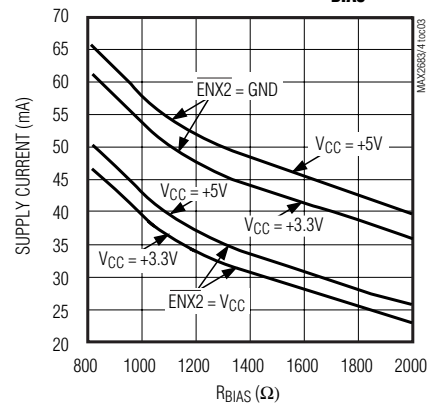

**CONVERSION GAIN vs. R\_BIAS**

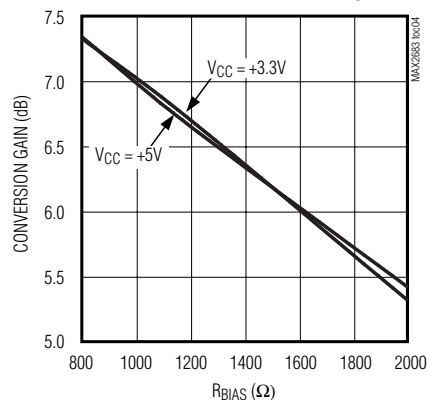

**INPUT IP3 vs. R\_BIAS**

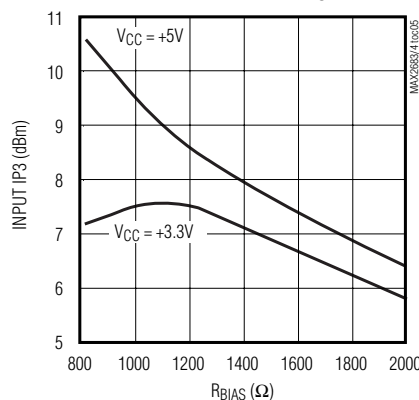

**INPUT P1dB vs. R\_BIAS**

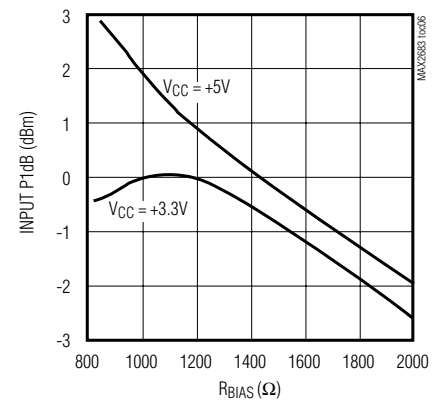

# 3.5GHz Downconverter Mixers with Selectable LO Doubler

MAX2683/MAX2684

## Typical Operating Characteristics (continued)

(MAX2683/MAX2684 EV kit,  $V_{CC} = +5V$ ,  $R_{BIAS} = 1.2k\Omega$ ,  $\overline{ENX2} = GND$ ,  $f_{RF} = 3.6GHz$ ,  $P_{RF} = -20dBm$ ,  $f_{LOX2} = 1650MHz$  for MAX2683 or  $f_{LOX2} = 1350MHz$  for MAX2684,  $P_{LO} = -5dBm$ , all input/output ports terminated in  $50\Omega$ , IFOUT+ and IFOUT- matched to single-ended  $50\Omega$  load,  $T_A = +25^\circ C$ , unless otherwise noted.)

### MAX2683

**CONVERSION GAIN vs. LO POWER**  
( $\overline{ENX2} = GND$ )

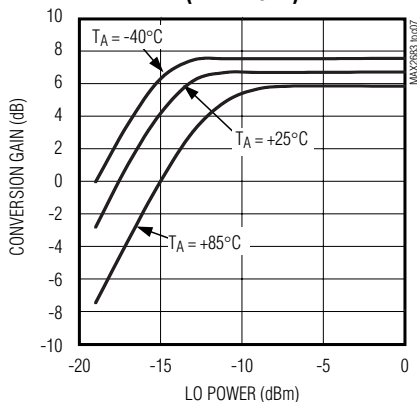

**CONVERSION GAIN vs. LO POWER**  
( $\overline{ENX2} = V_{CC}$ )

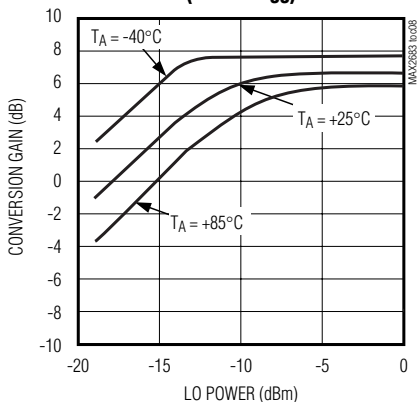

**NOISE FIGURE vs. LO POWER**

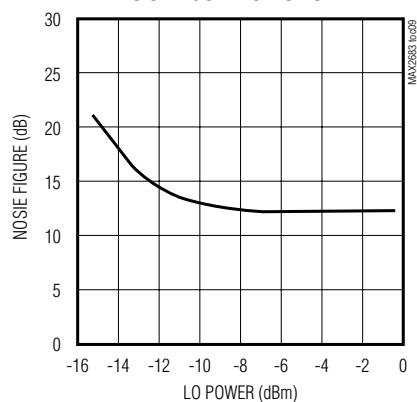

**CONVERSION GAIN vs. SUPPLY VOLTAGE**  
( $R_{BIAS} = 820\Omega$ )

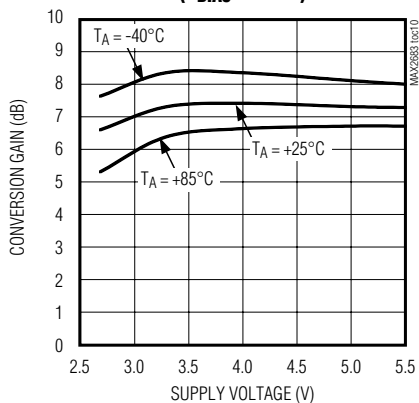

**CONVERSION GAIN vs. SUPPLY VOLTAGE**  
( $R_{BIAS} = 1.2k\Omega$ )

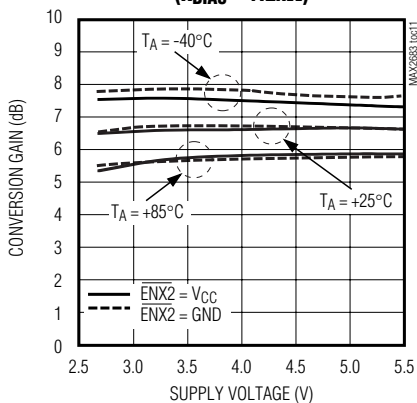

**CONVERSION GAIN vs. SUPPLY VOLTAGE**  
( $R_{BIAS} = 2k\Omega$ )

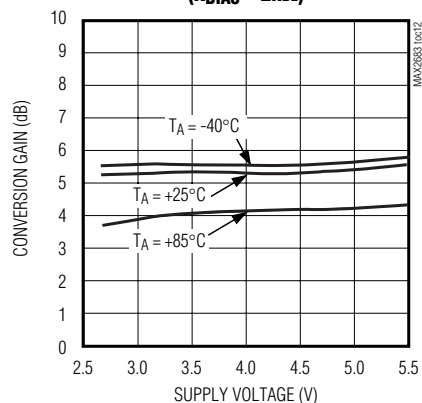

**INPUT IP3 vs. SUPPLY VOLTAGE**  
( $R_{BIAS} = 820\Omega$ )

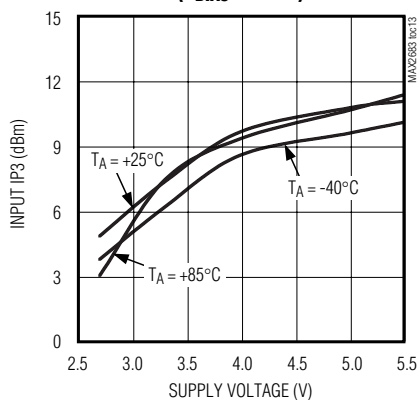

**INPUT IP3 vs. SUPPLY VOLTAGE**  
( $R_{BIAS} = 1.2k\Omega$ )

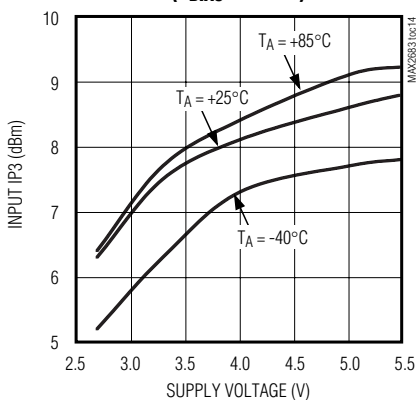

**INPUT IP3 vs. SUPPLY VOLTAGE**  
( $R_{BIAS} = 2k\Omega$ )

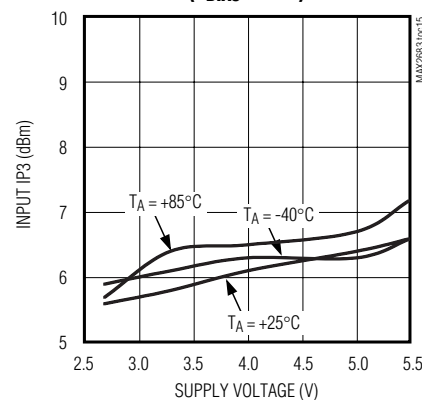

# 3.5GHz Downconverter Mixers with Selectable LO Doubler

## Typical Operating Characteristics (continued)

(MAX2683/MAX2684 EV kit,  $V_{CC} = +5V$ ,  $R_{BIAS} = 1.2k\Omega$ ,  $ENX2 = GND$ ,  $f_{RF} = 3.6GHz$ ,  $P_{RF} = -20dBm$ ,  $f_{LOX2} = 1650MHz$  for MAX2683 or  $f_{LOX2} = 1350MHz$  for MAX2684,  $P_{LO} = -5dBm$ , all input/output ports terminated in  $50\Omega$ , IFOUT+ and IFOUT- matched to single-ended  $50\Omega$  load,  $T_A = +25^\circ C$ , unless otherwise noted.)

### MAX2683

**INPUT P1dB vs. SUPPLY VOLTAGE**  
( $R_{BIAS} = 820\Omega$ )

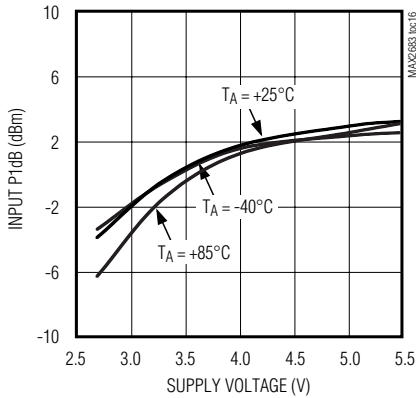

**INPUT P1dB vs. SUPPLY VOLTAGE**  
( $R_{BIAS} = 1.2k\Omega$ )

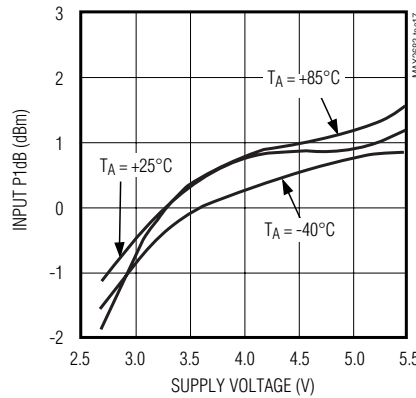

**INPUT P1dB vs. SUPPLY VOLTAGE**  
( $R_{BIAS} = 2k\Omega$ )

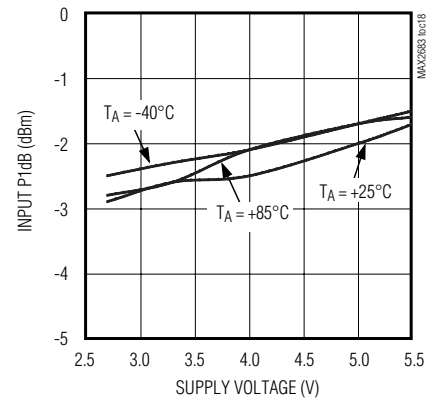

**CONVERSION GAIN vs. RF FREQUENCY**  
( $R_{BIAS} = 1.2k\Omega$ )

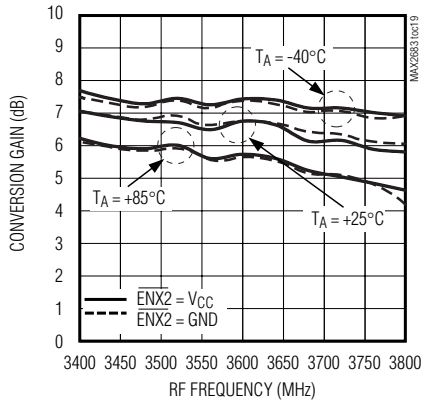

**CONVERSION GAIN vs. FREQUENCY**  
( $ENX2 = GND$ )

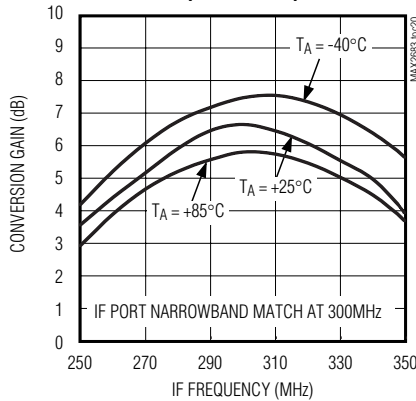

**CONVERSION GAIN vs. IF FREQUENCY**  
( $ENX2 = V_{CC}$ )

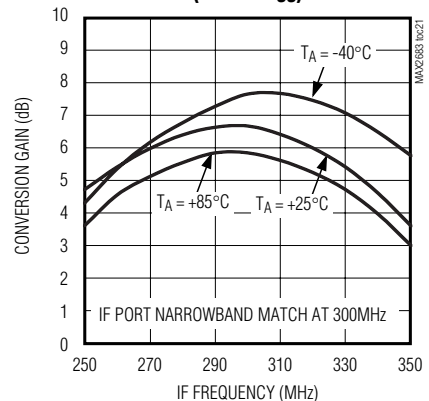

**LOX2 PORT RETURN LOSS vs. LO FREQUENCY**  
( $ENX2 = GND$ )

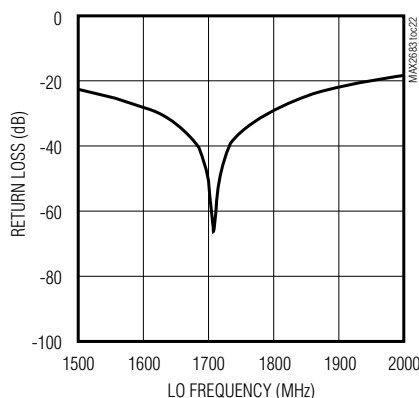

**LOX1 PORT RETURN LOSS vs. LO FREQUENCY**  
( $ENX2 = V_{CC}$ )

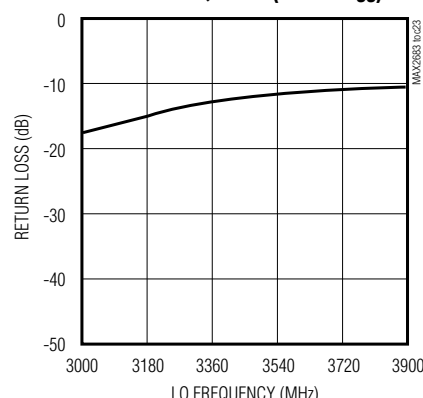

# 3.5GHz Downconverter Mixers with Selectable LO Doubler

## Typical Operating Characteristics (continued)

(MAX2683/MAX2684 EV kit,  $V_{CC} = +5V$ ,  $R_{BIAS} = 1.2k\Omega$ ,  $ENX2 = GND$ ,  $f_{RF} = 3.6GHz$ ,  $P_{RF} = -20dBm$ ,  $f_{LOX2} = 1650MHz$  for MAX2683 or  $f_{LOX2} = 1350MHz$  for MAX2684,  $P_{LO} = -5dBm$ , all input/output ports terminated in  $50\Omega$ , IFOUT+ and IFOUT- matched to single-ended  $50\Omega$  load,  $T_A = +25^\circ C$ , unless otherwise noted.)

MAX2683/MAX2684

**LOX1 S11 vs. R<sub>BIAS</sub>**  
( $ENX2 = V_{CC}$ )

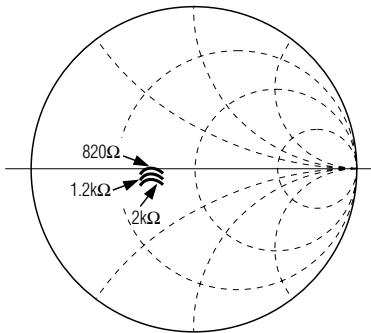

**MAX2683**  
**LOX2 S11 vs. R<sub>BIAS</sub>**  
( $ENX2 = GND$ )

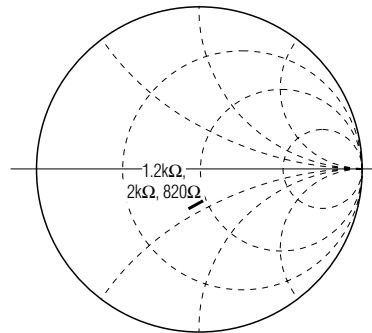

**MAX2683**  
**IF PORT S11 vs. R<sub>BIAS</sub>**

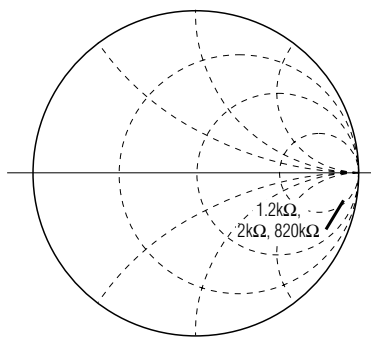

**MAX2683**  
**RFIN S11 vs. R<sub>BIAS</sub>**

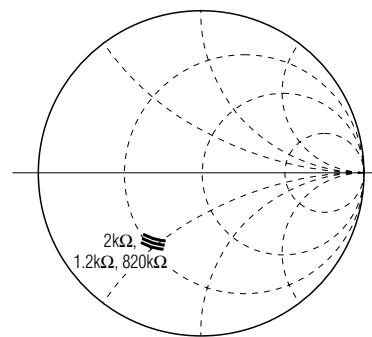

# 3.5GHz Downconverter Mixers with Selectable LO Doubler

## Typical Operating Characteristics (continued)

(MAX2683/MAX2684 EV kit,  $V_{CC} = +5V$ ,  $R_{BIAS} = 1.2k\Omega$ ,  $ENX2 = GND$ ,  $f_{RF} = 3.6GHz$ ,  $P_{RF} = -20dBm$ ,  $f_{LOX2} = 1650MHz$  for MAX2683 or  $f_{LOX2} = 1350MHz$  for MAX2684,  $P_{LO} = -5dBm$ , all input/output ports terminated in  $50\Omega$ , IFOUT+ and IFOUT- matched to single-ended  $50\Omega$  load,  $T_A = +25^\circ C$ , unless otherwise noted.)

### MAX2684

**SUPPLY CURRENT vs. SUPPLY VOLTAGE (ENX2 = GND)**

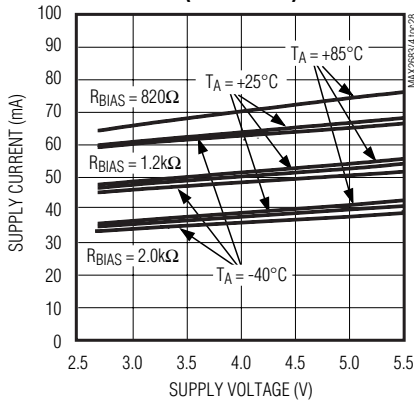

**SUPPLY CURRENT vs. SUPPLY VOLTAGE (ENX2 = VCC)**

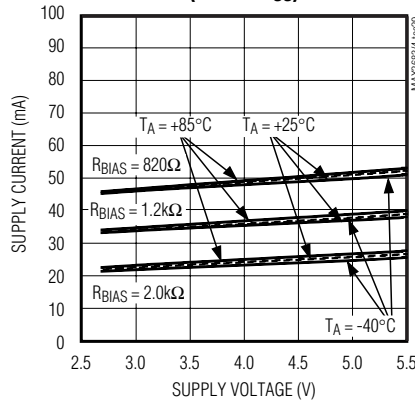

**SUPPLY CURRENT vs. R\_BIAS**

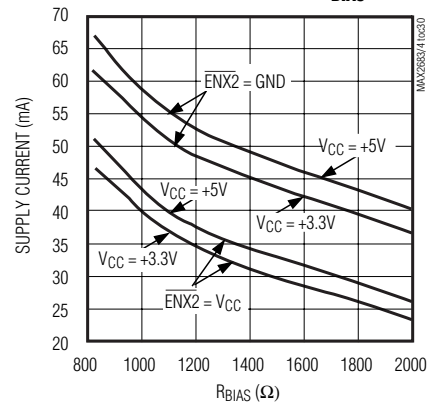

**CONVERSION GAIN vs. R\_BIAS**

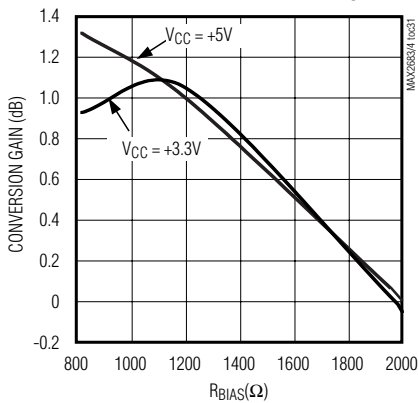

**INPUT IP3 vs. R\_BIAS**

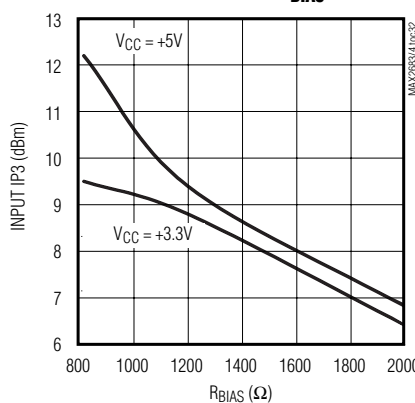

**INPUT P1dB vs. R\_BIAS**

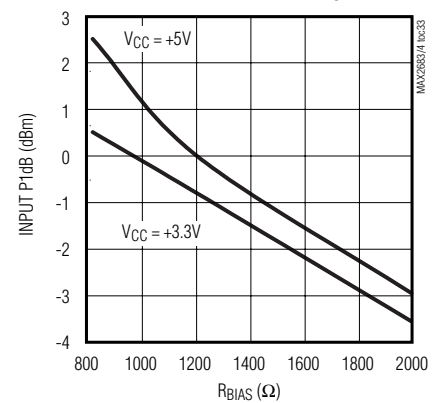

**CONVERSION GAIN vs. LO POWER (ENX2 = GND)**

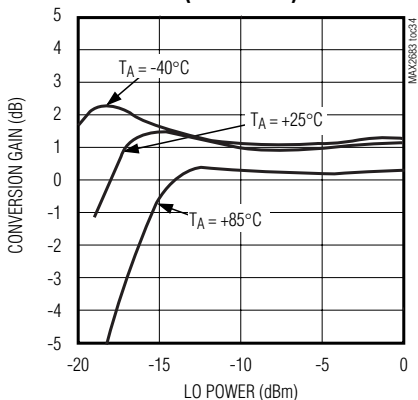

**CONVERSION GAIN vs. LO POWER (ENX2 = VCC)**

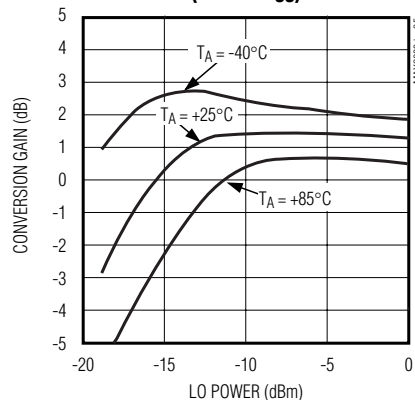

**NOISE FIGURE vs. LO POWER**

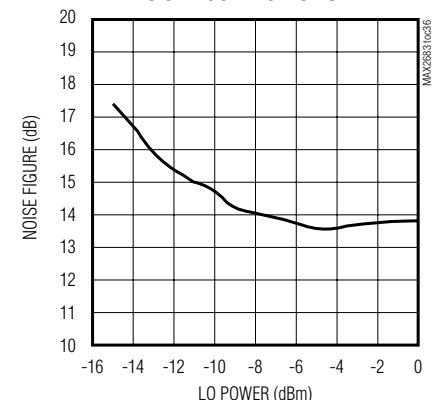



# 3.5GHz Downconverter Mixers with Selectable LO Doubler

## Typical Operating Characteristics (continued)

(MAX2683/MAX2684 EV kit,  $V_{CC} = +5V$ ,  $R_{BIAS} = 1.2k\Omega$ ,  $ENX2 = GND$ ,  $f_{RF} = 3.6GHz$ ,  $P_{RF} = -20dBm$ ,  $f_{LOX2} = 1650MHz$  for MAX2683 or  $f_{LOX2} = 1350MHz$  for MAX2684,  $P_{LO} = -5dBm$ , all input/output ports terminated in  $50\Omega$ , IFOUT+ and IFOUT- matched to single-ended  $50\Omega$  load,  $T_A = +25^\circ C$ , unless otherwise noted.)

MAX2683/MAX2684

### MAX2684

**CONVERSION GAIN vs. SUPPLY VOLTAGE**  
( $R_{BIAS} = 820\Omega$ )

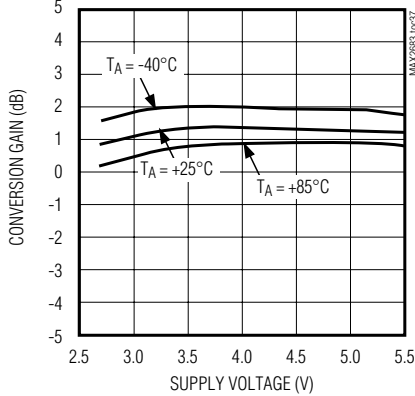

**CONVERSION GAIN vs. SUPPLY VOLTAGE**  
( $R_{BIAS} = 1.2k\Omega$ )

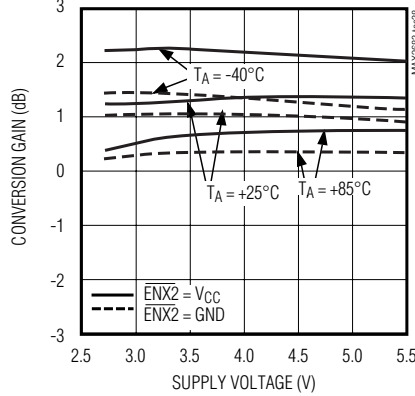

**CONVERSION GAIN vs. SUPPLY VOLTAGE**  
( $R_{BIAS} = 2k\Omega$ )

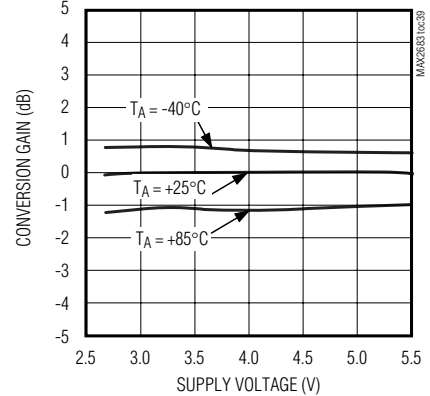

**INPUT IP3 vs. SUPPLY VOLTAGE**  
( $R_{BIAS} = 820\Omega$ )

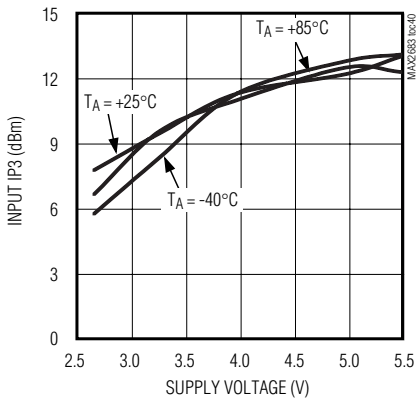

**INPUT IP3 vs. SUPPLY VOLTAGE**  
( $R_{BIAS} = 1.2k\Omega$ )

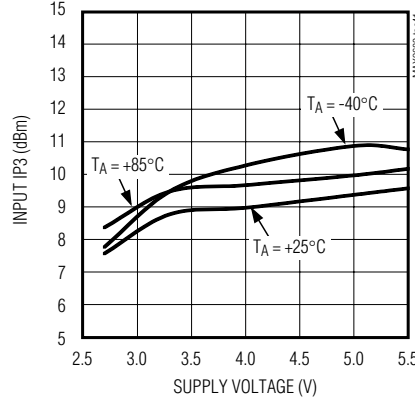

**INPUT IP3 vs. SUPPLY VOLTAGE**  
( $R_{BIAS} = 2k\Omega$ )

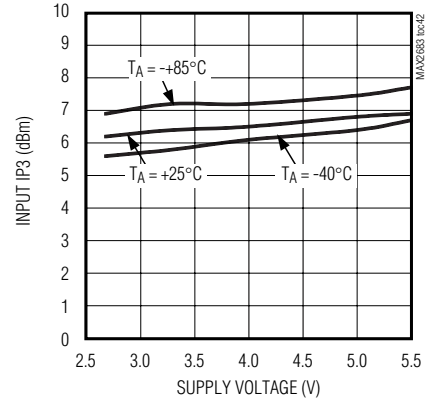

**INPUT P1dB vs. SUPPLY VOLTAGE**  
( $R_{BIAS} = 820\Omega$ )

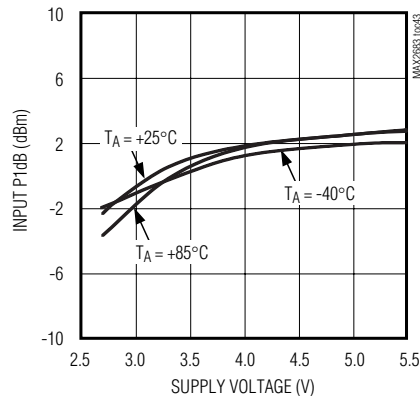

**INPUT P1dB vs. SUPPLY VOLTAGE**  
( $R_{BIAS} = 1.2k\Omega$ )

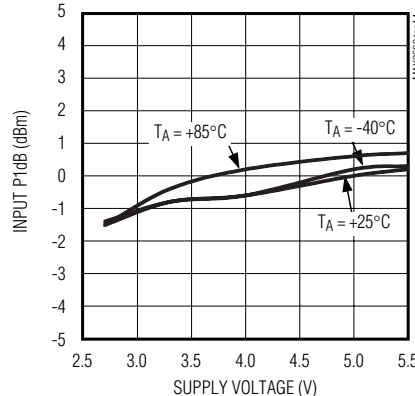

**INPUT P1dB vs. SUPPLY VOLTAGE**  
( $R_{BIAS} = 2k\Omega$ )

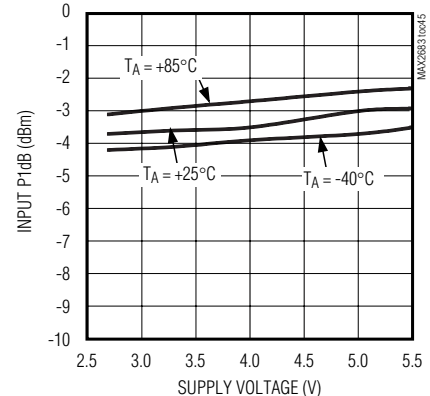

# 3.5GHz Downconverter Mixers with Selectable LO Doubler

## Typical Operating Characteristics (continued)

(MAX2683/MAX2684 EV kit,  $V_{CC} = +5V$ ,  $R_{BIAS} = 1.2k\Omega$ ,  $ENX2 = GND$ ,  $f_{RF} = 3.6GHz$ ,  $P_{RF} = -20dBm$ ,  $f_{LOX2} = 1650MHz$  for MAX2683 or  $f_{LOX2} = 1350MHz$  for MAX2684,  $P_{LO} = -5dBm$ , all input/output ports terminated in  $50\Omega$ , IFOUT+ and IFOUT- matched to single-ended  $50\Omega$  load,  $T_A = +25^\circ C$ , unless otherwise noted.)

### MAX2684

**CONVERSION GAIN vs. RF FREQUENCY (ENX2 = GND)**

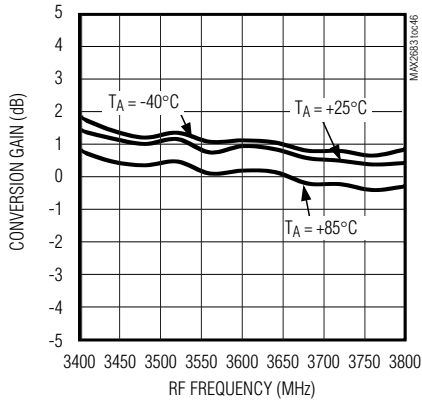

**CONVERSION GAIN vs. RF FREQUENCY (ENX2 = VCC)**

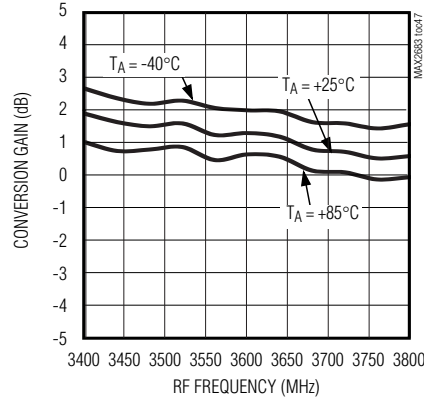

**CONVERSION GAIN vs. IF FREQUENCY (ENX2 = GND)**

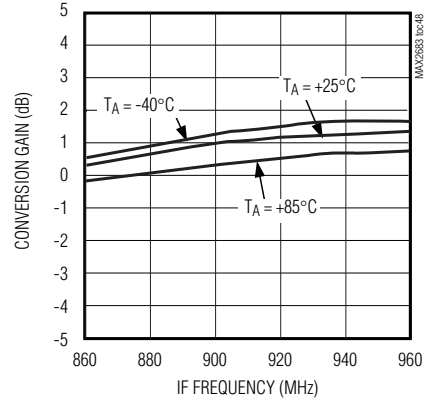

**CONVERSION GAIN vs. IF FREQUENCY (ENX2 = VCC)**

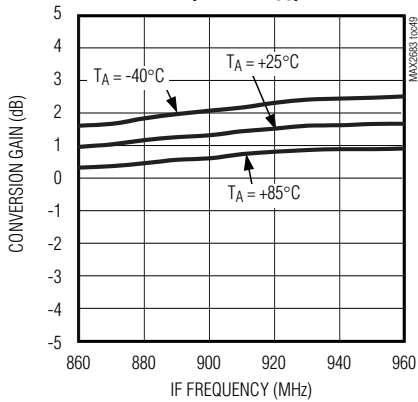

**LOX2 PORT RETURN LOSS vs. LO FREQUENCY**

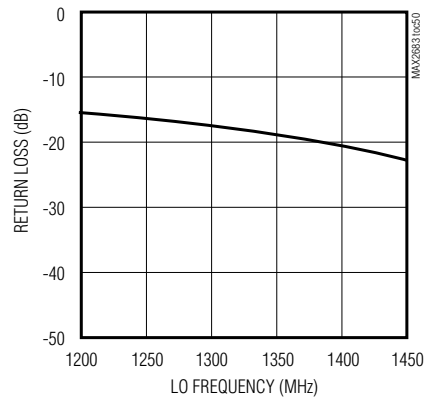

**LOX1 PORT RETURN LOSS vs. LO FREQUENCY**

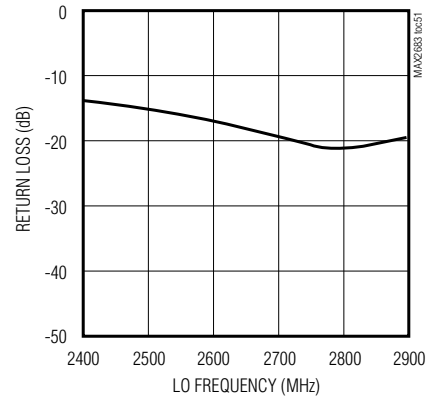

**LOX1 S11 vs. RBIAS (ENX2 = VCC)**

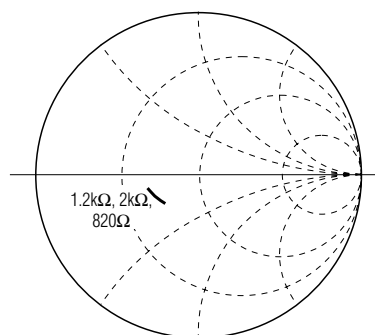

**LOX2 S11 vs. RBIAS (ENX2 = GND)**

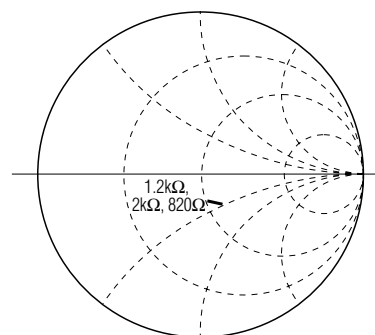

# 3.5GHz Downconverter Mixers with Selectable LO Doubler

## Typical Operating Characteristics (continued)

(MAX2683/MAX2684 EV kit,  $V_{CC} = +5V$ ,  $R_{BIAS} = 1.2k\Omega$ ,  $\overline{ENX2} = GND$ ,  $f_{RF} = 3.6GHz$ ,  $P_{RF} = -20dBm$ ,  $f_{LOX2} = 1650MHz$  for MAX2683 or  $f_{LOX2} = 1350MHz$  for MAX2684,  $P_{LO} = -5dBm$ , all input/output ports terminated in  $50\Omega$ , IFOUT+ and IFOUT- matched to single-ended  $50\Omega$  load,  $T_A = +25^\circ C$ , unless otherwise noted.)

### MAX2684

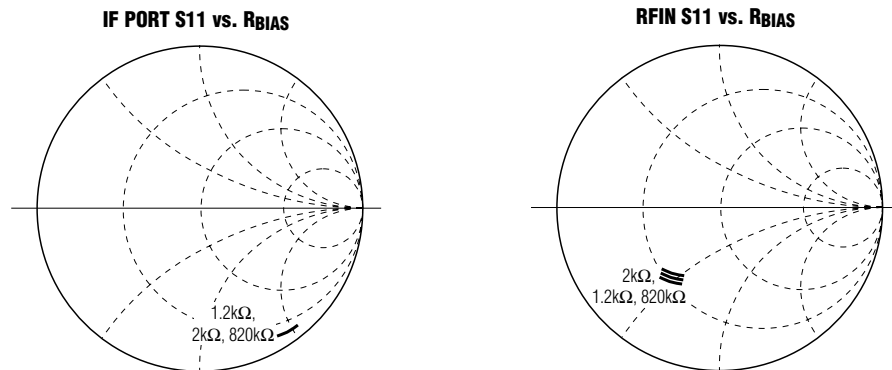

MAX2683/MAX2684

## Pin Description

PIN	NAME	FUNCTION
1	$V_{CC}$	Supply Voltage Input. Bypass with a 100pF capacitor as close to the pin as possible.
2, 3, 5, 9, 10, 12, 13, 15, EP	GND	Ground. Connect to ground plane with a low-inductance connection. Solder exposed paddle evenly to the board ground plane.
4	RFIN	RF Input Port to Mixer. Requires a matching network and a DC-blocking capacitor that may be part of this network.
6	$\overline{ENX2}$	LO Frequency-Doubler Enable Input. Drive low to enable the LO doubler and run external LO at half frequency. Drive high to disable the LO doubler and run external LO at full frequency.
7	LOX2	Half-Frequency Local-Oscillator Input to LO Frequency Doubler, LO Filter, and Downconverter Mixer. Requires a DC-blocking capacitor. Leave unconnected if this pin is not used.
8	LOX1	Full-Frequency Local-Oscillator Input to Downconverter Mixer. Requires a DC-blocking capacitor. Leave unconnected if this pin is not used.
11, 14	IFOUT-, IFOUT+	Differential, Open-Collector IF Output Ports of Mixer. Requires a matching network and pull-up inductors to $V_{CC}$ that can be part of this network.
16	BIAS	Bias-Setting Resistor Connection. A resistor, $R_{BIAS}$ , placed from BIAS to GND sets the linearity and supply current of the mixer.

## 3.5GHz Downconverter Mixers with Selectable LO Doubler

Table 1. MAX2683/MAX2684 RFIN Port S-Parameters (VCC = +5V, TA = +25°C)

RF FREQUENCY (MHz)	RBIAS = 820Ω		RBIAS = 1.2kΩ		RBIAS = 2kΩ	
	S11 MAG	S11 PHASE (degrees)	S11 MAG	S11 PHASE (degrees)	S11 MAG	S11 PHASE (degrees)
<b>MAX2683</b>						
3400	0.582	-113.3	0.561	-121.3	0.536	-122.3
3450	0.586	-114.8	0.564	-122.5	0.540	-123.5
3500	0.590	-116.2	0.567	-123.7	0.544	-124.7
3550	0.594	-117.5	0.570	-125.1	0.547	-126.0
3600	0.599	-118.7	0.574	-126.1	0.553	-127.0
3650	0.602	-120.0	0.576	-127.2	0.555	-128.1
3700	0.607	-121.2	0.580	-128.3	0.559	-129.1
3750	0.608	-122.3	0.583	-129.3	0.563	-130.1
3800	0.612	-123.5	0.587	-130.2	0.567	-131.0
<b>MAX2684</b>						
3400	0.578	-117.5	0.537	-119.7	0.512	-121.3
3450	0.582	-119.0	0.542	-121.2	0.518	-122.7
3500	0.586	-120.5	0.545	-122.6	0.523	-124.1
3550	0.590	-121.8	0.545	-122.7	0.527	-125.5
3600	0.595	-123.1	0.555	-125.4	0.533	-126.8
3650	0.599	-124.5	0.558	-126.7	0.537	-128.0
3700	0.604	-125.7	0.564	-127.8	0.542	-129.1
3750	0.606	-126.7	0.568	-128.9	0.546	-130.2
3800	0.611	-127.9	0.572	-129.9	0.552	-131.1

### Detailed Description

The MAX2683/MAX2684 are double-balanced down-converter mixers optimized for the 3.4GHz to 3.8GHz frequency band. The MAX2683 is designed for down-conversion to IF frequencies of 100MHz to 400MHz, while the MAX2684 is designed for IF frequencies of 800MHz to 1000MHz. In addition, the devices include a logic-level LO frequency doubler, an integrated LO filter, and externally programmable bias control circuitry.

#### RF Input

RFIN is a single-ended input that accepts frequencies in the 3.4GHz to 3.8GHz range. It requires a matching

network and a DC-blocking capacitor that may be part of this network. See *Typical Operation Circuit* for recommended component values. See Table 1 for RFIN port S-parameters.

#### LO Inputs, LO Frequency Doubler, and LO Filter

The MAX2683/MAX2684 feature an internal LO frequency doubler that allows the external LO to run at full or half frequency. Running the LO at half frequency has the benefit of reducing unwanted LO leakage through the low-noise amplifier (LNA) to the antenna, reducing injection pulling of the voltage-controlled oscillator

## 3.5GHz Downconverter Mixers with Selectable LO Doubler

MAX2683/MAX2684

**Table 2. MAX2683 LO Port S-Parameters (V<sub>CC</sub> = +5V, T<sub>A</sub> = +25°C)**

LOX2 ( $\overline{\text{ENX2}} = \text{GND}$ )			LOX1 ( $\overline{\text{ENX2}} = \text{V}_{\text{CC}}$ )		
LOX2 FREQUENCY (MHz)	S11 MAG	S11 PHASE (degrees)	LOX2 FREQUENCY (MHz)	S11 MAG	S11 PHASE (degrees)
<b>R<sub>BIAS</sub> = 820Ω</b>					
1500	0.234	-82.0	3000	0.362	-163.5
1575	0.237	-86.7	3150	0.358	-165.4
1650	0.241	-91.1	3300	0.338	-167.0
1725	0.247	-95.3	3450	0.306	-167.3
1800	0.254	-98.9	3600	0.271	-164.9
1875	0.262	-102.3	3750	0.235	-160.6
1950	0.268	-104.9	3900	0.200	-154.8
<b>R<sub>BIAS</sub> = 1.2kΩ</b>					
1500	0.211	-77.9	3000	0.343	-159.1
1575	0.213	-83.7	3150	0.341	-160.0
1650	0.217	-89.3	3300	0.330	-162.3
1725	0.222	-94.5	3450	0.310	-162.0
1800	0.230	-99.3	3600	0.285	-160.2
1875	0.240	-103.6	3750	0.256	-156.4
1950	0.249	-107.1	3900	0.224	-151.1
<b>R<sub>BIAS</sub> = 2.0kΩ</b>					
1500	0.213	-78.0	3000	0.339	-155.2
1575	0.214	-83.7	3150	0.340	-156.0
1650	0.218	-89.3	3300	0.332	-156.0
1725	0.223	-94.5	3450	0.315	-155.3
1800	0.231	-99.3	3600	0.294	-153.3
1875	0.241	-103.7	3750	0.268	-150.0
1950	0.249	-107.2	3900	0.240	-145.5

(VCO) from the PA, and reducing the demands of designing a high-frequency VCO. An internal LO band-pass filter is integrated after the frequency doubler to help reduce LO harmonic content and spurious mixing.

To enable the LO frequency doubler, drive  $\overline{\text{ENX2}}$  to a logic-low level and connect the half-frequency external LO to the LOX2 port. To disable and bypass the LO frequency doubler and LO filter, drive  $\overline{\text{ENX2}}$  to a logic-high level and connect the full-frequency external LO to

## 3.5GHz Downconverter Mixers with Selectable LO Doubler

Table 3. MAX2684 LO Port S-Parameters ( $V_{CC} = +5V$ ,  $T_A = +25^\circ C$ )

LOX2 ( $\overline{ENX2} = GND$ )			LOX1 ( $\overline{ENX2} = V_{CC}$ )		
LOX2 FREQUENCY (MHz)	S11 MAG	S11 PHASE (degrees)	LOX1 FREQUENCY (MHz)	S11 MAG	S11 PHASE (degrees)
<b>R<sub>BIAS</sub> = 820Ω</b>					
1200	0.225	-59.6	2400	0.249	-138.9
1250	0.219	-62.8	2500	0.266	-143.5
1300	0.215	-66.0	2600	0.281	-147.5
1350	0.212	-69.1	2700	0.296	-152.1
1400	0.210	-72.4	2800	0.305	-158.8
1450	0.209	-75.4	2900	0.302	-167.3
<b>R<sub>BIAS</sub> = 1.2kΩ</b>					
1200	0.228	-64.7	2400	0.235	-135.3
1250	0.222	-68.9	2500	0.251	-139.8
1300	0.219	-71.2	2600	0.265	-143.5
1350	0.216	-74.4	2700	0.280	-147.8
1400	0.214	-77.8	2800	0.290	-152.8
1450	0.213	-81.0	2900	0.292	-157.0
<b>R<sub>BIAS</sub> = 2.0kΩ</b>					
1200	0.212	-75.4	2400	0.224	-132.3
1250	0.222	-63.1	2500	0.240	-136.6
1300	0.217	-66.2	2600	0.255	-140.1
1350	0.213	-69.2	2700	0.269	-143.8
1400	0.211	-72.3	2800	0.279	-147.6
1450	0.209	-75.3	2900	0.283	-150.3

the LOX1 port. Disabling the LO doubler has the benefit of reducing the supply current by 15mA. See Tables 2 and 3 for the LO input frequency ranges.

LOX1 and LOX2 are single-ended LO inputs that achieve a return loss of typically -20dB over the specified LO input frequency range. They are internally biased and require a DC-blocking capacitor. To improve LOX2 input return loss, use a series inductor between the blocking capacitor and LOX2 input. See

the *Typical Operating Circuit* for recommended component values. See Tables 2 and 3 for LOX1 and LOX2 S-parameters. Leave the unused port unconnected.

### IF Output

The MAX2683 is optimized for IF frequencies in the 100MHz to 400MHz range, while the MAX2684 is optimized for IF frequencies in the 900MHz to 1000MHz range. The differential, open-collector IFOUT- and IFOUT+ ports require external pull-up inductors to  $V_{CC}$ ,

## 3.5GHz Downconverter Mixers with Selectable LO Doubler

**Table 4. MAX2683 IFOUT Port S-Parameters (VCC = +5V, TA = +25°C)**

RF FREQUENCY (MHz)	RBIAS = 820Ω		RBIAS = 1.2kΩ		RBIAS = 1.2kΩ	
	S11 MAG	S11 PHASE (degrees)	S11 MAG	S11 PHASE (degrees)	S11 MAG	S11 PHASE (degrees)
150	0.915	-11.3	0.914	-11.2	0.930	-10.9
200	0.907	-14.8	0.905	-14.7	0.920	-14.2
250	0.904	-17.7	0.905	-17.8	0.917	-17.2
300	0.899	-21.3	0.900	-21.3	0.911	-20.3
350	0.894	-24.5	0.893	-24.5	0.907	-23.5

**Table 5. MAX2684 IFOUT Port S-Parameters (VCC = +5V, TA = +25°C)**

RF FREQUENCY (MHz)	RBIAS = 820Ω		RBIAS = 1.2kΩ		RBIAS = 1.2kΩ	
	S11 MAG	S11 PHASE (degrees)	S11 MAG	S11 PHASE (degrees)	S11 MAG	S11 PHASE (degrees)
860	0.955	-49.4	0.955	-49.6	0.955	-49.7
880	0.952	-50.3	0.952	-50.5	0.950	-50.6
900	0.950	-51.1	0.948	-51.4	0.946	-51.4
920	0.946	-52.0	0.944	-52.3	0.941	-52.3
940	0.943	-53.0	0.940	-53.1	0.937	-53.3
960	0.941	-53.6	0.936	-54.0	0.935	-53.8

as well as an output matching network for optimum performance. See *Typical Operating Circuit* for recommended component values. See Tables 4 and 5 for IFOUT port S-parameters.

### **Bias Circuitry**

The linearity and supply current of the MAX2683/MAX2684 are externally programmable with a single resistor, RBIAS, from BIAS to GND. A nominal resistor value of 1.2kΩ will set an IIP3 of +9dBm and a supply current of 55mA. Decreasing the resistor value improves linearity at the cost of increased supply current. Increasing the resistor value decreases supply current while degrading linearity. Use resistor values in the range of 820kΩ to 2kΩ.

## **Applications Information**

### **Layout Considerations**

A properly designed PC board is an essential part of any RF/microwave circuit. Keep RF signal lines as short as possible to reduce losses, radiation, and inductance. Use separate, low-inductance vias to the ground plane for each ground pin. For best performance, solder the exposed pad on the bottom of the device package evenly to the board ground plane.

### **Power-Supply and ENX2 Bypassing**

Proper voltage-supply bypassing is essential for high-frequency circuit stability. Bypass VCC with a 10μF capacitor in parallel with a 100pF capacitor located as close to the VCC pin as possible.

Bypass ENX2 with a 100pF capacitor to ground to minimize noise injected into the LO doubler cell. Use a series resistor (typically 1.2kΩ) to further reduce coupling of high-frequency signals into the ENX2 pin.

# 3.5GHz Downconverter Mixers with Selectable LO Doubler

## Typical Operating Circuit

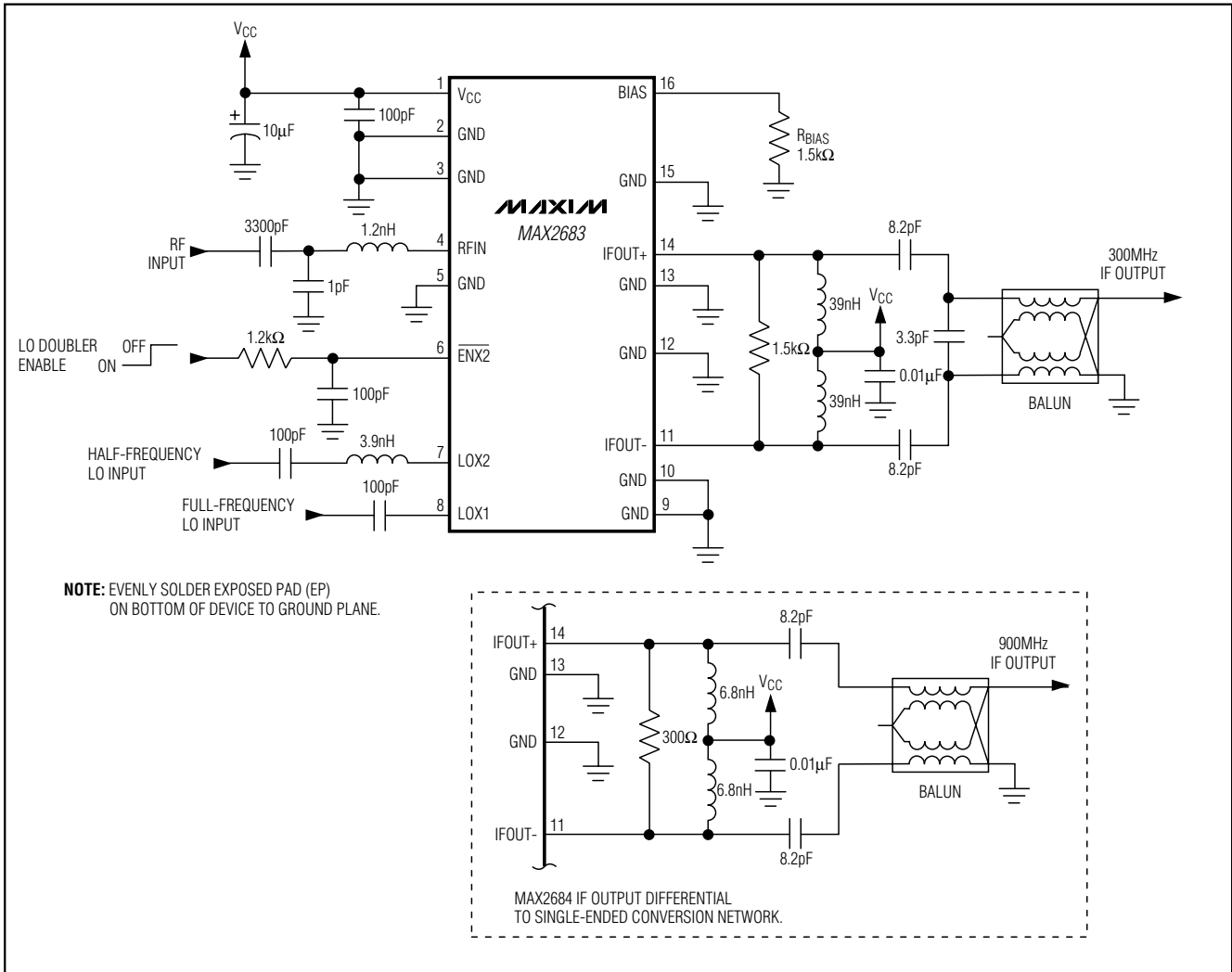



# 3.5GHz Downconverter Mixers with Selectable LO Doubler

## Package Information

(The package drawing(s) in this data sheet may not reflect the most current specifications. For the latest package outline information go to [www.maxim-ic.com/packages](http://www.maxim-ic.com/packages).)

MAX2683/MAX2684

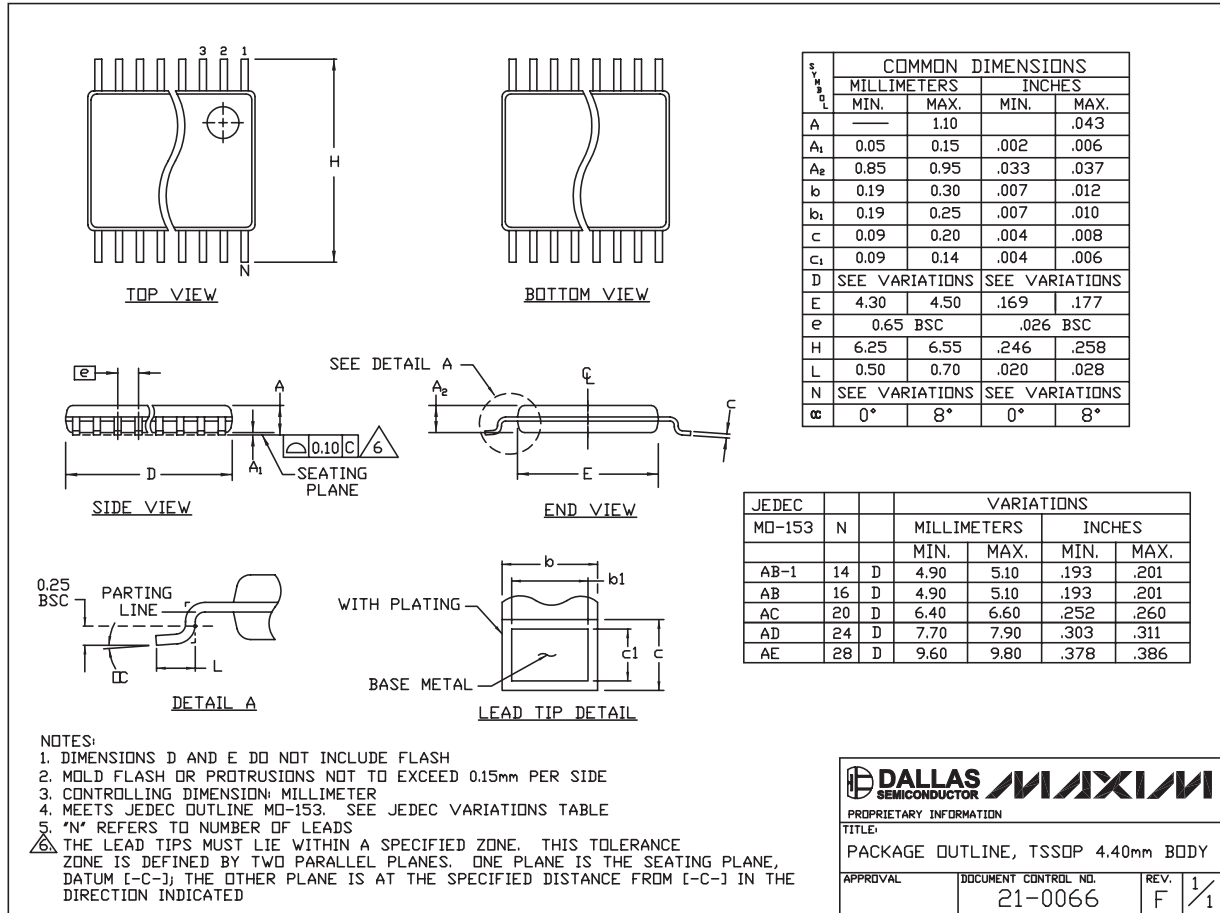

TSSOP4.40mm:EPS

Maxim cannot assume responsibility for use of any circuitry other than circuitry entirely embodied in a Maxim product. No circuit patent licenses are implied. Maxim reserves the right to change the circuitry and specifications without notice at any time.

Maxim Integrated Products, 120 San Gabriel Drive, Sunnyvale, CA 94086 408-737-7600 17