

FEATURES

- RF range: 6 GHz to 10 GHz
- LO input frequency range: 6 GHz to 10 GHz
- Conversion loss: 8 dB typical at 6 GHz to 10 GHz
- Image rejection: 23 dBc typical at 6 GHz to 10 GHz
- LO to RF isolation: 43 dB typical
- LO to IF isolation: 25 dB typical
- Input IP3: 19 dBm typical
- Input P1dB compression: 10 dBm typical at 7.1 GHz to 8.5 GHz
- Wide IF frequency range: dc to 3.5 GHz
- 24-terminal, ceramic leadless chip carrier

APPLICATIONS

- Point to point microwave radios
- Point to multipoint radios
- Video satellites
- Digital radios
- Instrumentation
- Automatic test equipment

GENERAL DESCRIPTION

The [HMC520A](#) is a compact gallium arsenide (GaAs), monolithic microwave integrated circuit (MMIC), in-phase quadrature (I/Q) mixer in a 24-terminal, RoHS compliant, ceramic leadless chip carrier (LCC) package. The device can be used as either an image reject mixer or a single sideband upconverter. The mixer uses two standard double balanced

FUNCTIONAL BLOCK DIAGRAM

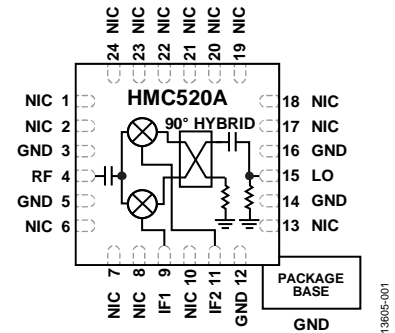

Figure 1.

mixer cells and a 90° hybrid fabricated in a GaAs, metal semiconductor field effect transistor (MESFET) process. The [HMC520A](#) is a smaller alternative to a hybrid style image reject mixer and a single sideband upconverter assembly. The [HMC520A](#) eliminates the need for wire bonding, allowing the use of surface-mount manufacturing techniques.

TABLE OF CONTENTS

Features 1

Applications 1

Functional Block Diagram 1

General Description 1

Revision History 2

Specifications 3

Absolute Maximum Ratings 4

 Thermal Resistance 4

 ESD Caution 4

Pin Configuration and Function Descriptions 5

 Interface Schematics 5

Typical Performance Characteristics 6

 Downconverter Performance: IF = 100 MHz, Lower Sideband (High-Side LO) 6

 Downconverter Performance: IF = 100 MHz, Upper Sideband (Low-Side LO) 8

 Downconverter Performance: IF = 1500 MHz, Lower Sideband (High-Side LO) 10

 Downconverter Performance: IF = 1500 MHz, Upper Sideband (Low-Side LO) 12

 Downconverter Performance: IF = 3500 MHz, Lower Sideband (High-Side LO) 14

REVISION HISTORY

6/2018—Rev. 0 to Rev. A

Changes to Table 1 3

Changes to Table 2, Thermal Resistance Section, and Table 3 ... 4

Changes to Figure 2 5

Deleted Table 6 Title Through Table 9 Title; Renumbered Sequentially 24

Changes to Theory of Operation Section 25

Changes to Applications Information Section and Figure 83... 26

Added Performance Up to 13 GHz Section and Figure 84 Through Figure 86; Renumbered Sequentially 26

Downconverter Performance: IF = 3500 MHz, Upper Sideband (Low-Side LO) 16

Upconverter Performance: IF Input Frequency (IF_{IN}) = 100 MHz, Lower Sideband (High-Side LO) 18

Amplitude and Phase Balance Downconverter: IF = 100 MHz, Lower Sideband (High-Side LO) 19

Amplitude and Phase Balance Downconverter: IF = 1500 MHz, Lower Sideband (High-Side LO) 20

Amplitude and Phase Balance Downconverter: IF = 3500 MHz, Lower Sideband (High-Side LO) 21

IF Bandwidth, Downconverter Performance 22

Isolation and Return Loss 23

Spurious and Harmonics Performance 24

Theory of Operation 25

Applications Information 26

 Performance to 13 GHz 26

 Soldering Information and Recommended Land Pattern 30

 Evaluation Board Information 31

Outline Dimensions 32

 Ordering Guide 32

Added Figure 87 Through Figure 92 27

Added Figure 93 Through Figure 98 28

Added Figure 99 Through Figure 104 29

Added Soldering Information and Recommended Land Pattern Section and Figure 105 30

Added Note 1 and Note 2, Table 6 31

Updated Outline Dimensions 32

Changes to Ordering Guide 32

1/2017—Revision 0: Initial Version

SPECIFICATIONS

Local oscillator (LO) = 15 dBm, intermediate frequency (IF) = 100 MHz, radio frequency (RF) = -10 dBm, and $T_A = 25^\circ\text{C}$, unless otherwise noted. All measurements were made as a downconverter with the lower sideband selected (high-side LO) and an external 90° IF hybrid at the IF ports, unless otherwise noted.

Table 1.

Parameter	Test Conditions/Comments	Min	Typ	Max	Unit
RF RANGE ¹		6		10	GHz
LO INPUT FREQUENCY RANGE		6		10	GHz
IF FREQUENCY RANGE		DC		3.5	GHz
LO AMPLITUDE			15		dBm
6 GHz TO 10 GHz DOWNCONVERTER PERFORMANCE					
Conversion Loss			8	10	dB
Noise Figure			8.5		dB
Input Third-Order Intercept (IP3)			19		dBm
Input Power for 1dB Compression (P1dB)			10.5		dBm
Image Rejection		19	23		dBc
LO to RF Isolation	Taken without external 90° IF hybrid	38	43		dB
LO to IF Isolation	Taken without external 90° IF hybrid		25		dB
Phase Balance	Taken without external 90° IF hybrid		5		Degrees
Amplitude Balance	Taken without external 90° IF hybrid		0.3		dB
7.1 GHz TO 8.5 GHz DOWNCONVERTER PERFORMANCE					
Conversion Loss			7.7	9.5	dB
Noise Figure			8		dB
Input IP3			19		dBm
Input P1dB			10		dBm
Image Rejection		21	25		dBc
LO to RF Isolation	Taken without external 90° IF hybrid	38	43		dB
LO to IF Isolation	Taken without external 90° IF hybrid		25		dB
Phase Balance	Taken without external 90° IF hybrid		4		Degrees
Amplitude Balance	Taken without external 90° IF hybrid		0.3		dB
6 GHz TO 10 GHz UPCONVERTER PERFORMANCE					
Conversion Loss			7.5		dB
Input IP3			18		dBm
Sideband Rejection			22		dBc

¹ For RF performance from 10 GHz to 13 GHz, see the Performance to 13 GHz section.

ABSOLUTE MAXIMUM RATINGS

Table 2.

Parameter	Rating
RF Input Power	20 dBm
LO Input Power	27 dBm
IF1 and IF2 Input Power	20 dBm
IF Source or Sink Current	12 mA
Maximum Peak Reflow Temperature	260°C
Maximum Junction Temperature (T _J)	175°C
Lifetime at Maximum T _J	>1 × 10 ⁶ Hours
Moisture Sensitivity Level (MSL) ¹	MSL3
Continuous Power Dissipation, P _{DISS} ² (T _A = 85°C, Derate 4.44 mW/°C Above 85°C)	400 mW
Operating Temperature Range	–40°C to +85°C
Storage Temperature Range	–65°C to +150°C
Lead Temperature Range (Soldering 60 sec)	–65°C to +150°C
Electrostatic Discharge (ESD) Sensitivity	
Human Body Model (HBM)	750 V (Class 1B)
Field Induced Charged Device Model (FICDM)	1250 V (Class C3)

¹ Based on IPC/JEDEC J-STD-20 MSL classifications.² P_{DISS} is a theoretical number calculated by (T_J – 85°C)/θ_{JC}.

Stresses at or above those listed under Absolute Maximum Ratings may cause permanent damage to the product. This is a stress rating only; functional operation of the product at these or any other conditions above those indicated in the operational section of this specification is not implied. Operation beyond the maximum operating conditions for extended periods may affect product reliability.

THERMAL RESISTANCE

Thermal performance is directly linked to printed circuit board (PCB) design and operating environment. Careful attention to PCB thermal design is required.

θ_{JA} is the natural convection, junction to ambient thermal resistance measured in a one cubic foot sealed enclosure. θ_{JC} is the junction to case thermal resistance.

Table 3. Thermal Resistance

Package Type	θ _{JA}	θ _{JC}	Unit
E-24-1 ¹	175°C	225	°C/W

¹ See JEDEC standard JESD51-2 for additional information on optimizing the thermal impedance (PCB with 3 × 3 vias).

ESD CAUTION



ESD (electrostatic discharge) sensitive device. Charged devices and circuit boards can discharge without detection. Although this product features patented or proprietary protection circuitry, damage may occur on devices subjected to high energy ESD. Therefore, proper ESD precautions should be taken to avoid performance degradation or loss of functionality.

PIN CONFIGURATION AND FUNCTION DESCRIPTIONS

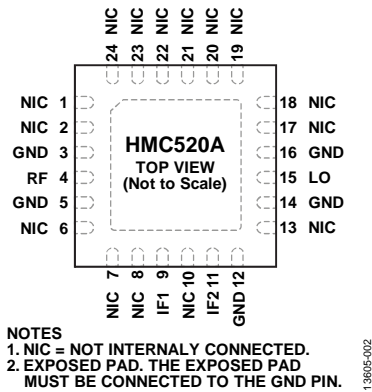

Figure 2. Pin Configuration

Table 4. Pin Function Descriptions

Pin No.	Mnemonic	Description
1, 2, 6 to 8, 10, 13, 17 to 24	NIC	Not Internally Connected.
3, 5, 12, 14, 16	GND	Ground. See Figure 7 for the GND interface schematic.
4	RF	RF Port. This pin is ac-coupled internally and matched to 50 Ω. See Figure 3 for the RF interface schematic.
9, 11	IF1, IF2	First and Second Quadrature IF Input Pins. For applications that do not require operation to dc, use an off chip dc blocking capacitor. For applications that require operation to dc, these pins must not source or sink more than 12 mA of current because the device may not function or possible device failure may result. See Figure 5 and Figure 6 for the IF1 and IF2 interface schematics.
15	LO EPAD	LO Port. This pin is dc-coupled and matched to 50 Ω. See Figure 4 for the LO interface schematic. Exposed Pad. The exposed pad must be connected to the GND pin.

INTERFACE SCHEMATICS

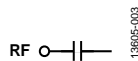

Figure 3. RF Interface Schematic

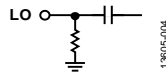

Figure 4. LO Interface Schematic

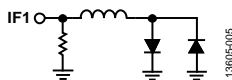

Figure 5. IF1 Interface Schematic

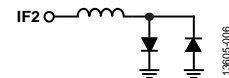

Figure 6. IF2 Interface Schematic



Figure 7. GND Interface Schematic

TYPICAL PERFORMANCE CHARACTERISTICS

DOWNCONVERTER PERFORMANCE: IF = 100 MHz, LOWER SIDEBAND (HIGH-SIDE LO)

Data taken as an image reject mixer with external 90° hybrid at the IF ports, LO = 15 dBm, unless otherwise noted.

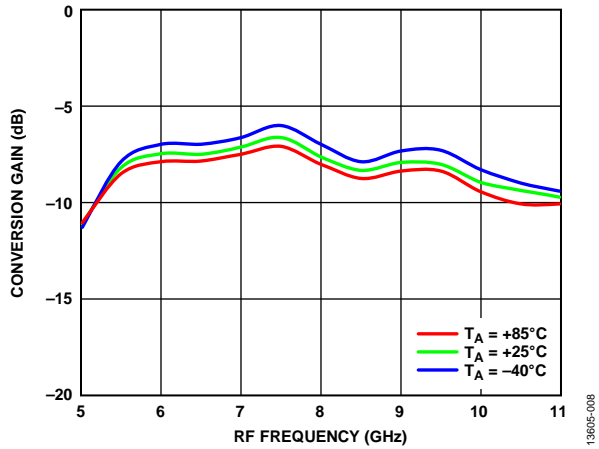

Figure 8. Conversion Gain vs. RF Frequency at Various Temperatures

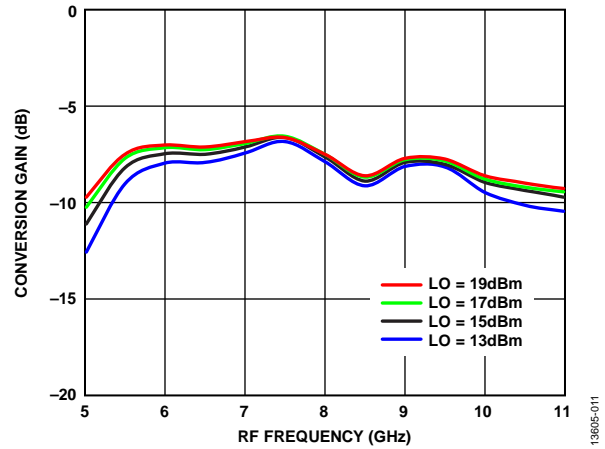

Figure 11. Conversion Gain vs. RF Frequency at Various LO Powers, $T_A = 25^\circ\text{C}$

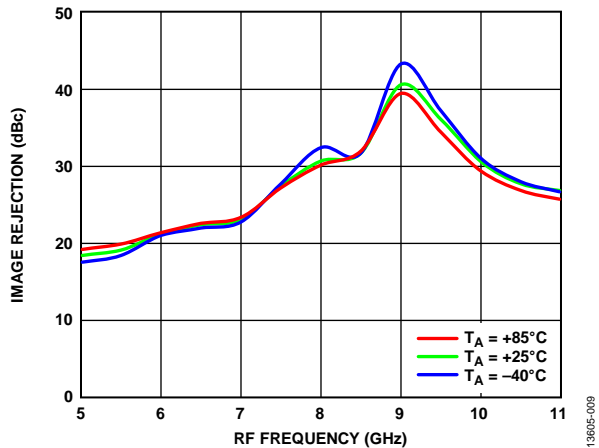

Figure 9. Image Rejection vs. RF Frequency at Various Temperatures

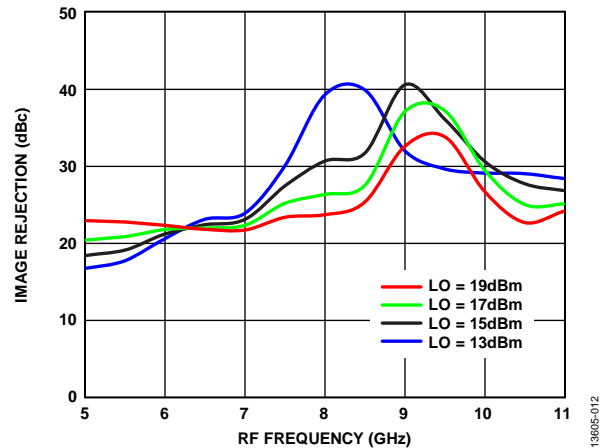

Figure 12. Image Rejection vs. RF Frequency at Various LO Powers, $T_A = 25^\circ\text{C}$

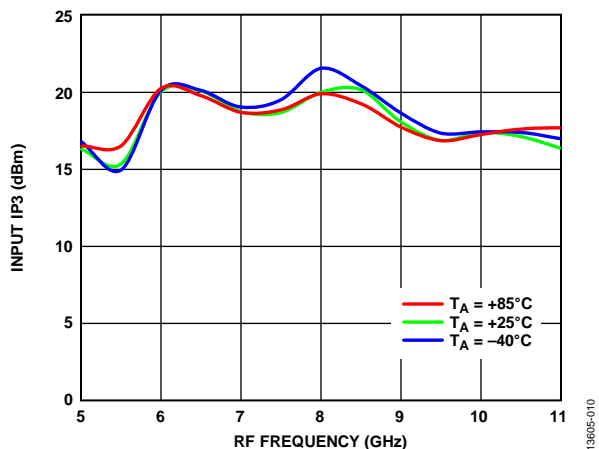

Figure 10. Input IP3 vs. RF Frequency at Various Temperatures

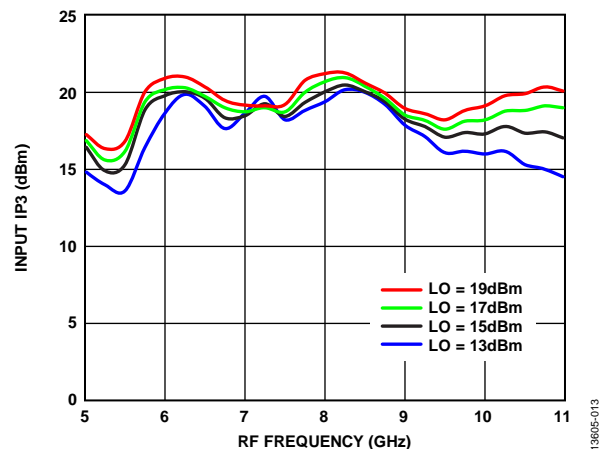

Figure 13. Input IP3 vs. RF Frequency at Various LO Powers, $T_A = 25^\circ\text{C}$

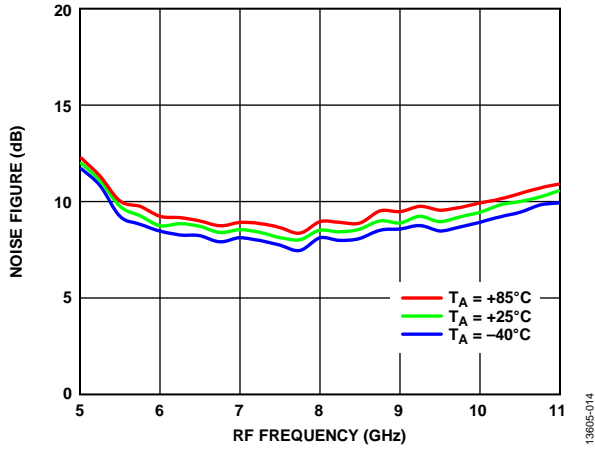

Figure 14. Noise Figure vs. RF Frequency at Various Temperatures

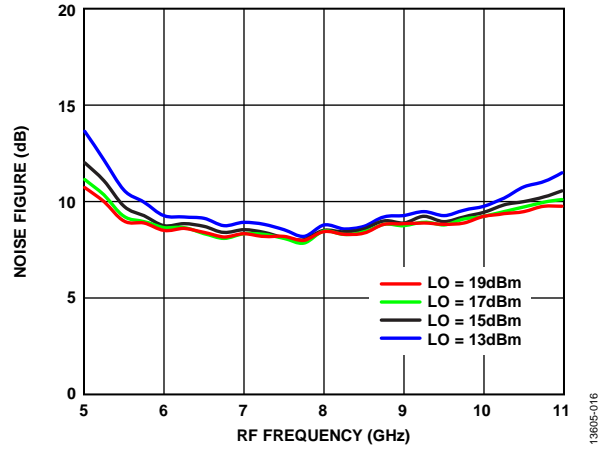

Figure 16. Noise Figure vs. RF Frequency at Various LO Powers, $T_A = 25^\circ\text{C}$

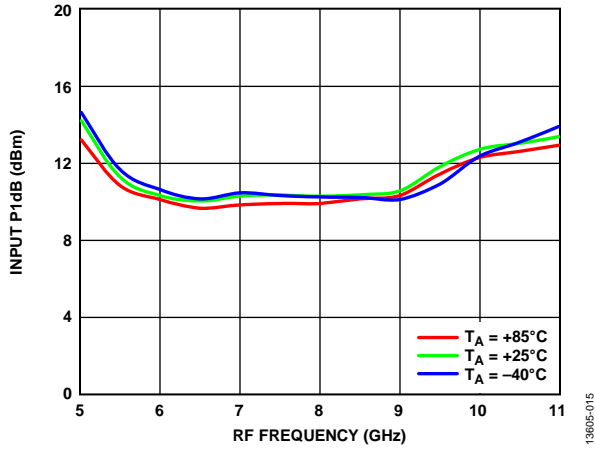

Figure 15. Input P1dB vs. RF Frequency at Various Temperatures

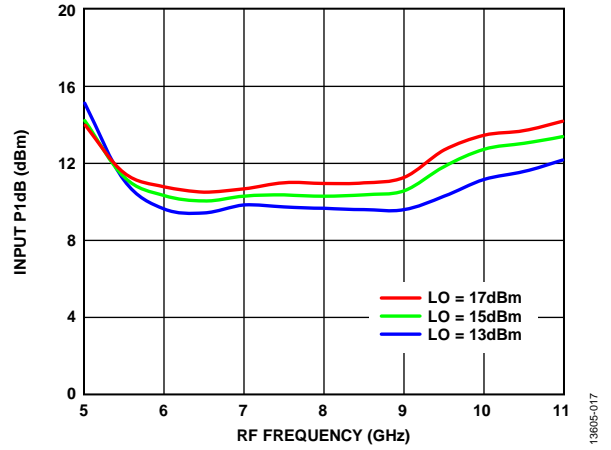

Figure 17. Input P1dB vs. RF Frequency at Various LO Powers, $T_A = 25^\circ\text{C}$

DOWNCONVERTER PERFORMANCE: IF = 100 MHz, UPPER SIDEBAND (LOW-SIDE LO)

Data taken as an image reject mixer with external 90° hybrid at the IF ports, LO = 15 dBm, unless otherwise noted.

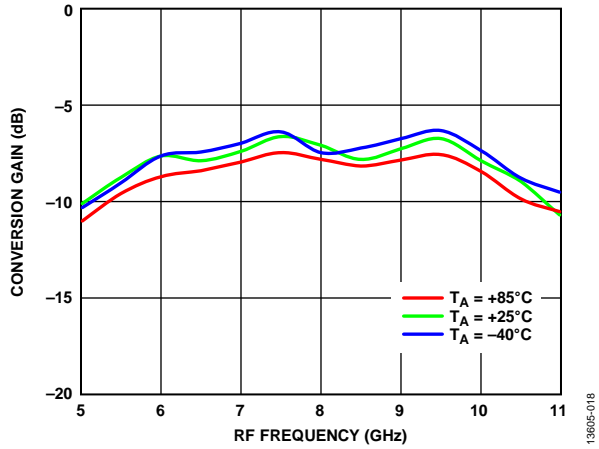

Figure 18. Conversion Gain vs. RF Frequency at Various Temperatures

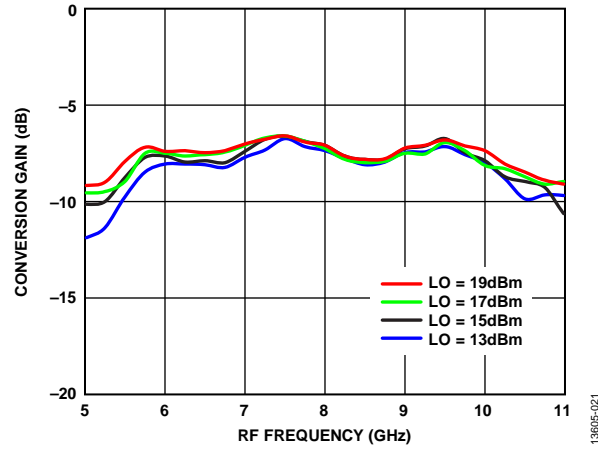

Figure 21. Conversion Gain vs. RF Frequency at Various LO Powers, $T_A = 25^\circ\text{C}$

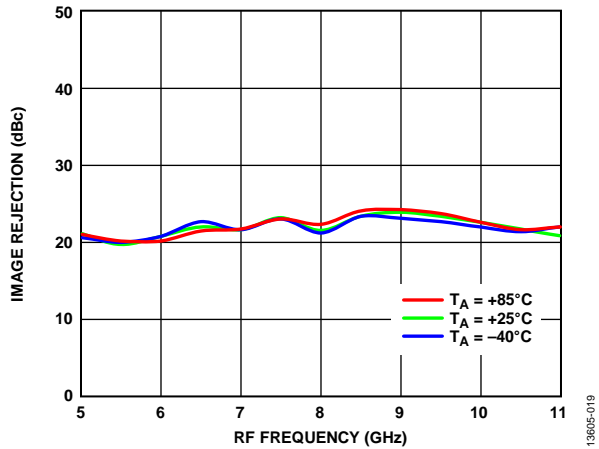

Figure 19. Image Rejection vs. RF Frequency at Various Temperatures

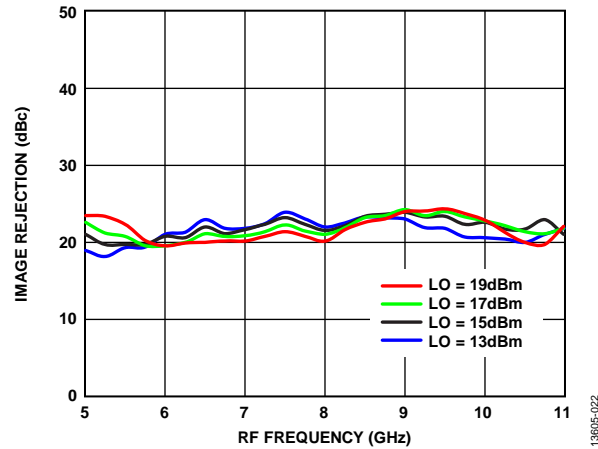

Figure 22. Image Rejection vs. RF Frequency at Various LO Powers, $T_A = 25^\circ\text{C}$

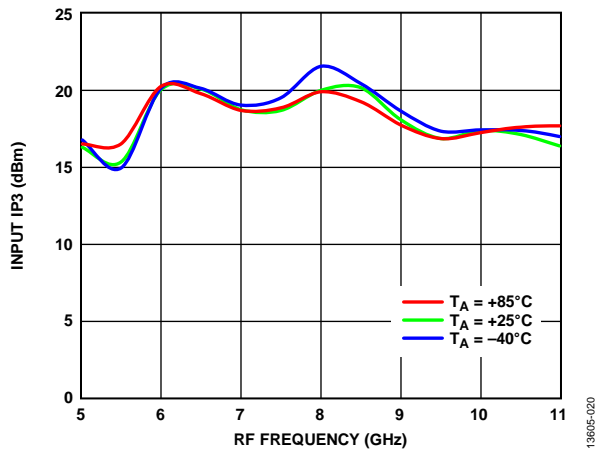

Figure 20. Input IP3 vs. RF Frequency at Various Temperatures

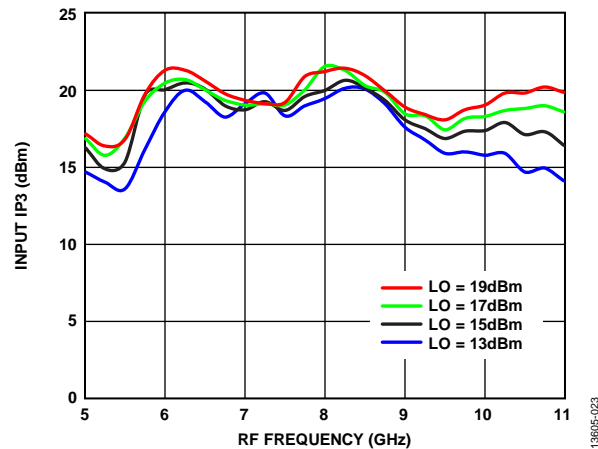

Figure 23. Input IP3 vs. RF Frequency at Various LO Powers, $T_A = 25^\circ\text{C}$

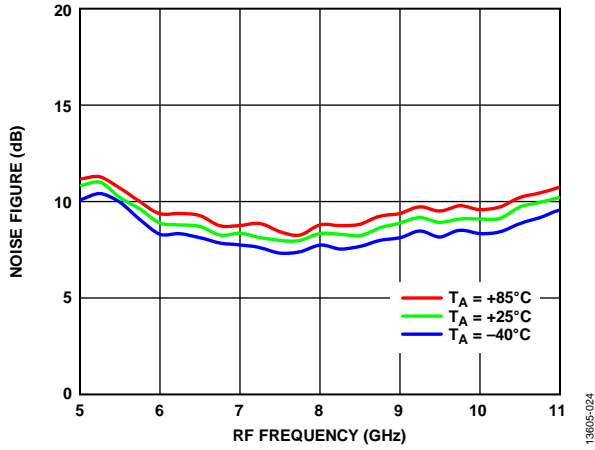

Figure 24. Noise Figure vs. RF Frequency at Various Temperatures

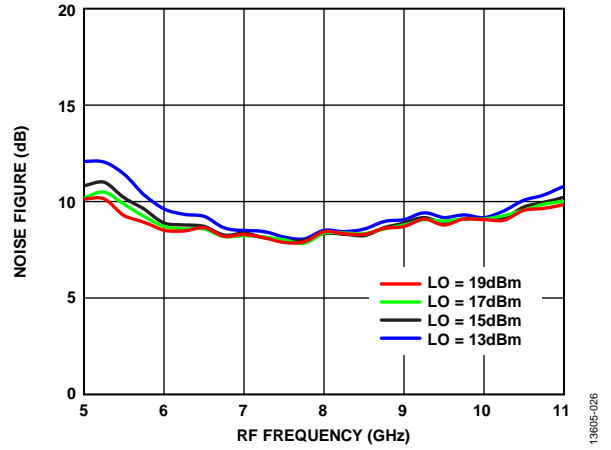

Figure 26. Noise Figure vs. RF Frequency at Various LO Powers, $T_A = 25^\circ\text{C}$

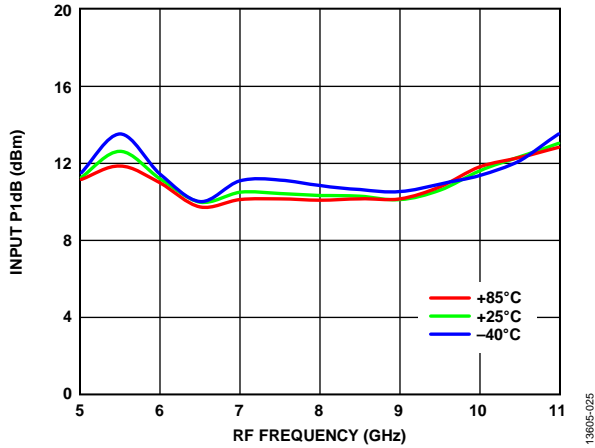

Figure 25. Input P1dB vs. RF Frequency at Various Temperatures

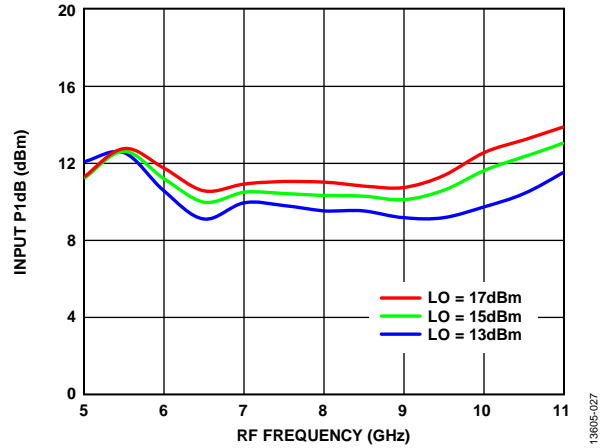

Figure 27. Input P1dB vs. RF Frequency at Various LO Powers, $T_A = 25^\circ\text{C}$

DOWNCONVERTER PERFORMANCE: IF = 1500 MHz, LOWER SIDEBAND (HIGH-SIDE LO)

Data taken as an image reject mixer with external 90° hybrid at the IF ports, LO = 15 dBm, unless otherwise noted.

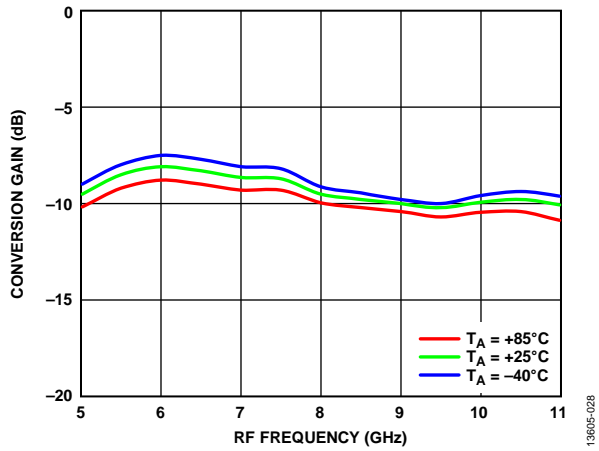

Figure 28. Conversion Gain vs. RF Frequency at Various Temperatures

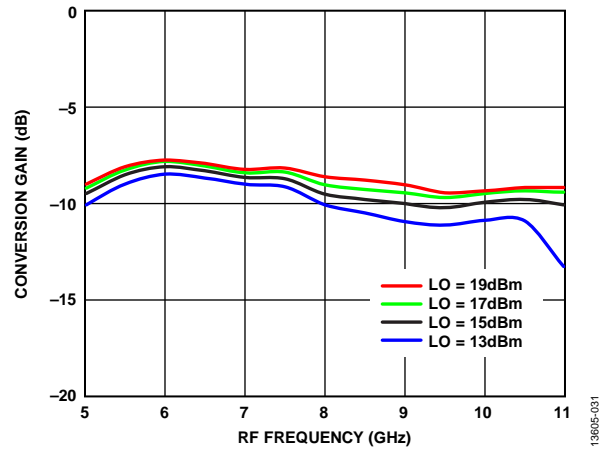

Figure 31. Conversion Gain vs. RF Frequency at Various LO Powers, $T_A = 25^\circ\text{C}$

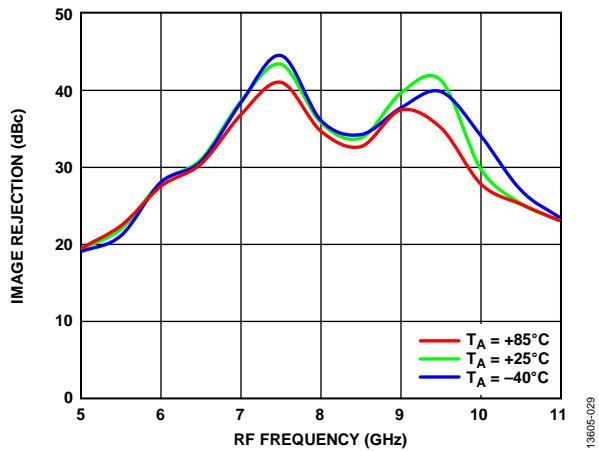

Figure 29. Image Rejection vs. RF Frequency at Various Temperatures

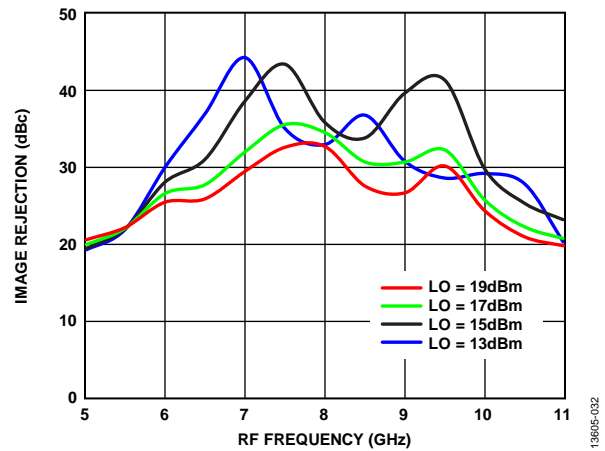

Figure 32. Image Rejection vs. RF Frequency at Various LO Powers, $T_A = 25^\circ\text{C}$

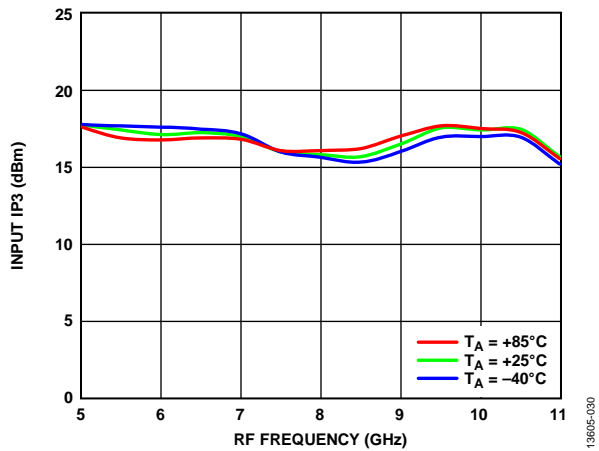

Figure 30. Input IP3 vs. RF Frequency at Various Temperatures

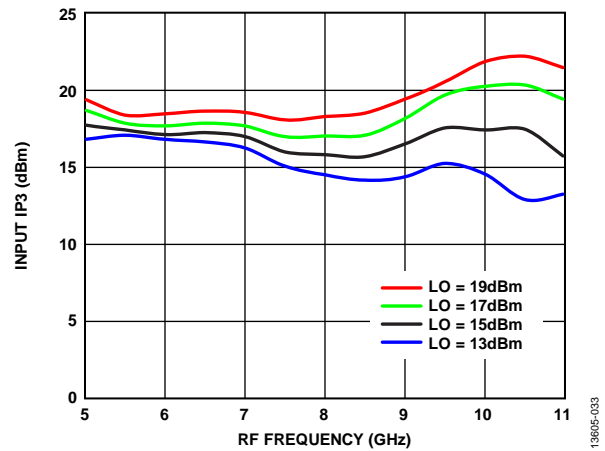

Figure 33. Input IP3 vs. RF Frequency at Various LO Powers, $T_A = 25^\circ\text{C}$

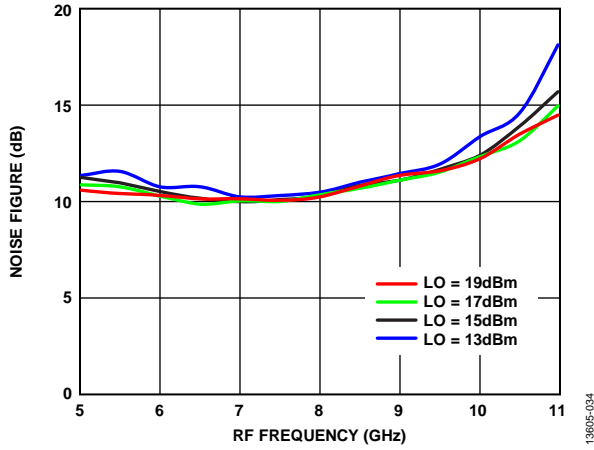

Figure 34. Noise Figure vs. RF Frequency at Various LO Powers, $T_A = 25^\circ\text{C}$

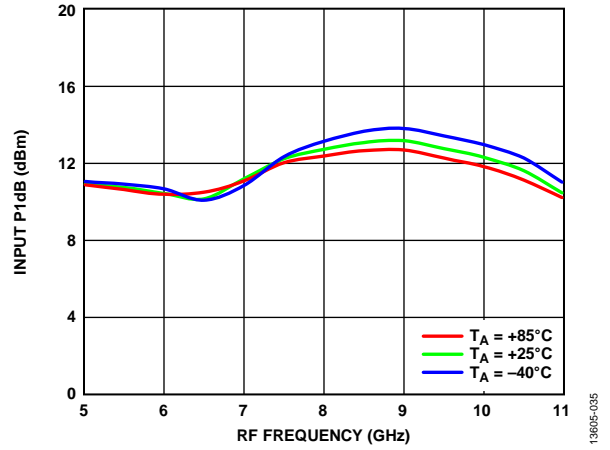

Figure 35. Input P1dB vs. RF Frequency at Various Temperatures

DOWNCONVERTER PERFORMANCE: IF = 1500 MHz, UPPER SIDEBAND (LOW-SIDE LO)

Data taken as an image reject mixer with external 90° hybrid at the IF ports, LO = 15 dBm, unless otherwise noted.

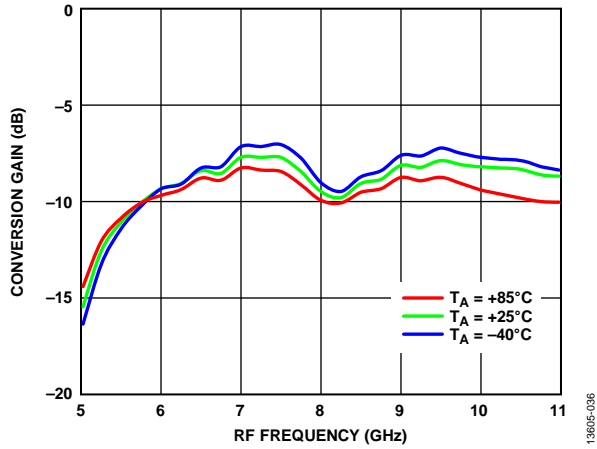

Figure 36. Conversion Gain vs. RF Frequency at Various Temperatures

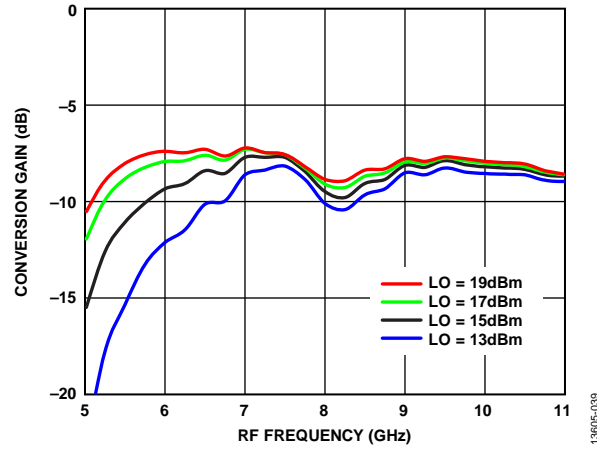

Figure 39. Conversion Gain vs. RF Frequency at Various LO Powers, $T_A = 25^\circ\text{C}$

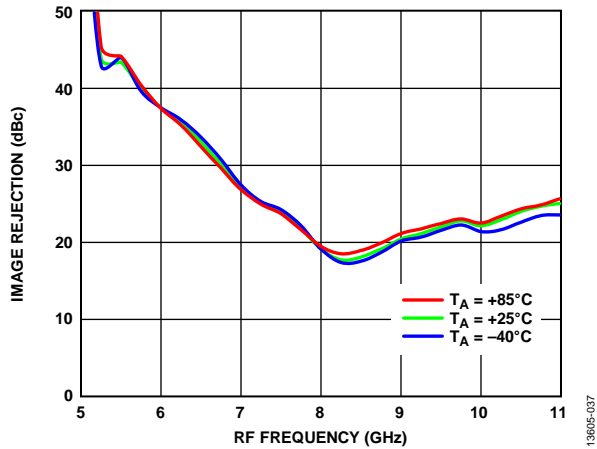

Figure 37. Image Rejection vs. RF Frequency at Various Temperatures

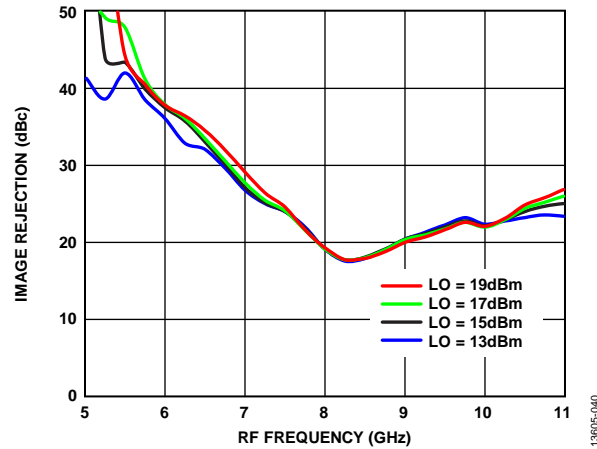

Figure 40. Image Rejection vs. RF Frequency at Various LO Powers

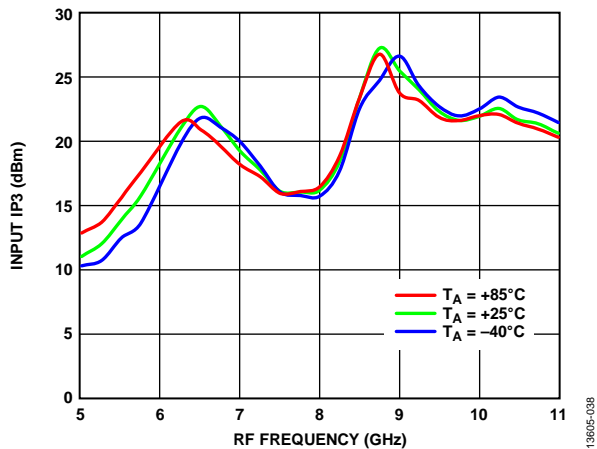

Figure 38. Input IP3 vs. RF Frequency at Various Temperatures

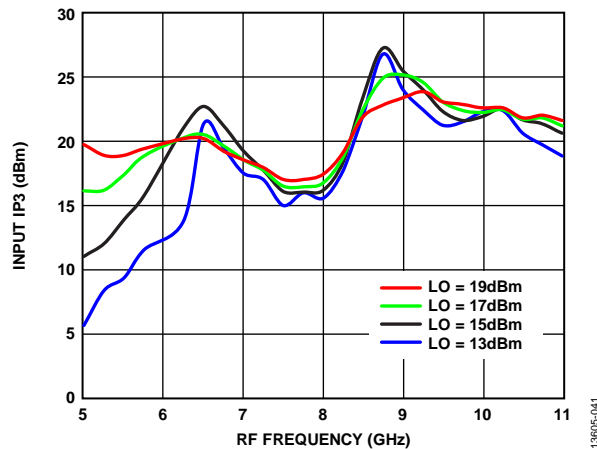

Figure 41. Input IP3 vs. RF Frequency at Various LO Powers, $T_A = 25^\circ\text{C}$

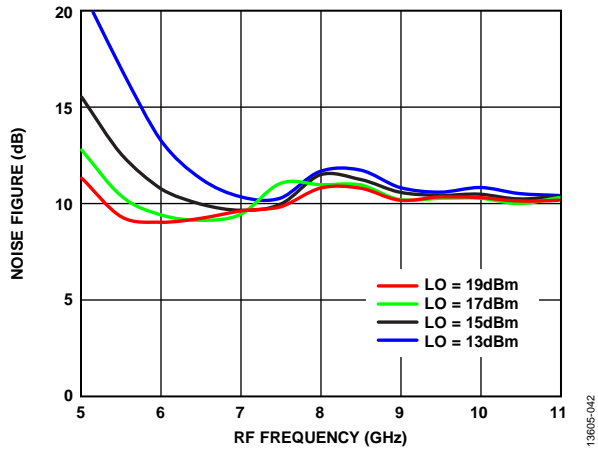

Figure 42. Noise Figure vs. RF Frequency at Various LO Powers, $T_A = 25^\circ\text{C}$

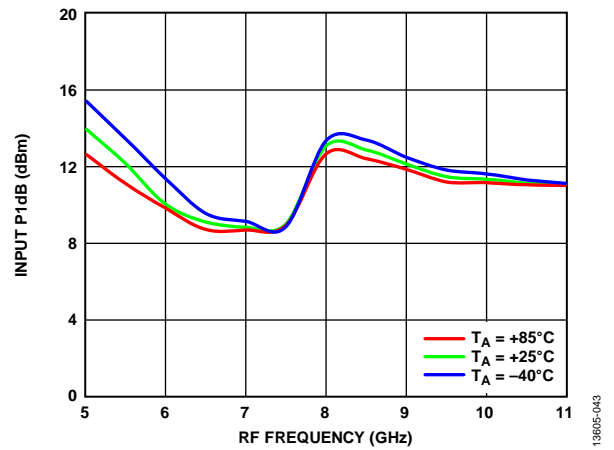

Figure 43. Input P1dB vs. RF Frequency at Various Temperatures

DOWNCONVERTER PERFORMANCE: IF = 3500 MHz, LOWER SIDEBAND (HIGH-SIDE LO)

Data taken as an image reject mixer with external 90° hybrid at the IF ports, LO = 15 dBm, unless otherwise noted.

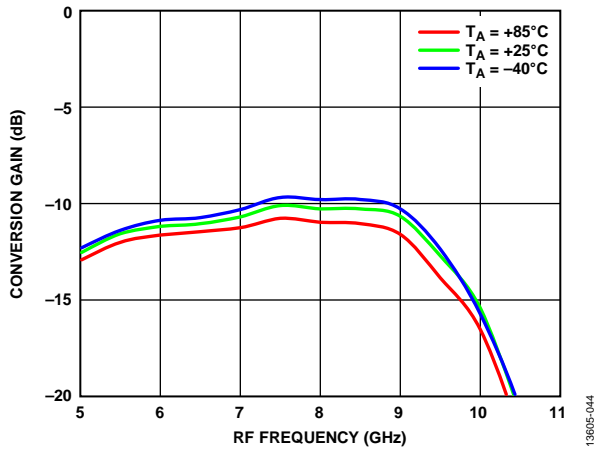

Figure 44. Conversion Gain vs. RF Frequency at Various Temperatures

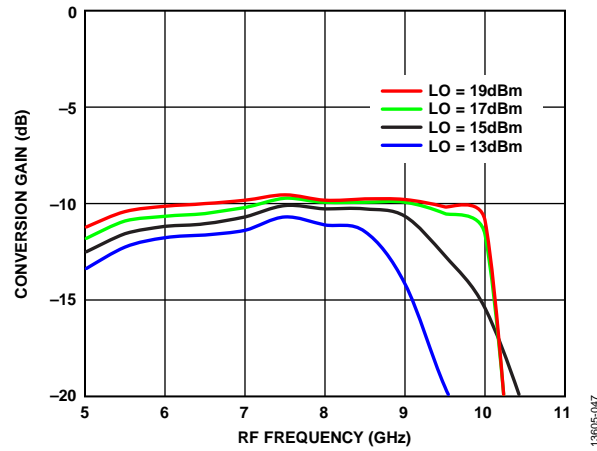

Figure 47. Conversion Gain vs. RF Frequency at Various LO Powers, $T_A = 25^\circ\text{C}$

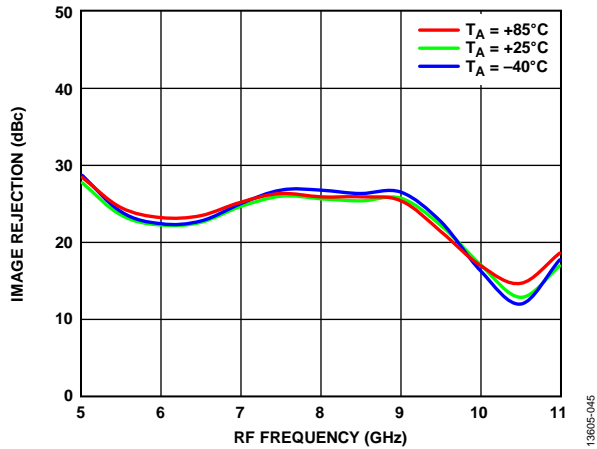

Figure 45. Image Rejection vs. RF Frequency at Various Temperatures

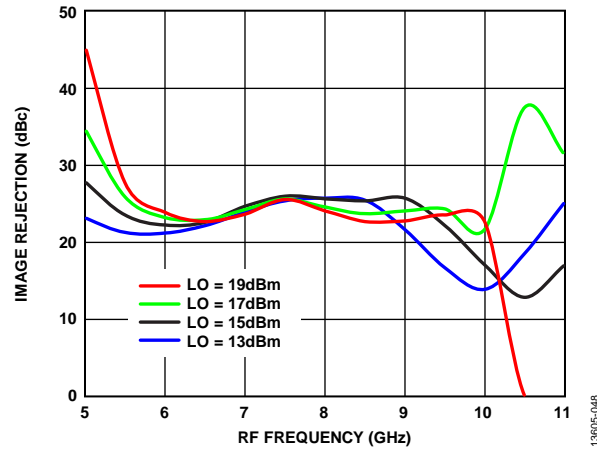

Figure 48. Image Rejection vs. RF Frequency at Various LO Powers, $T_A = 25^\circ\text{C}$

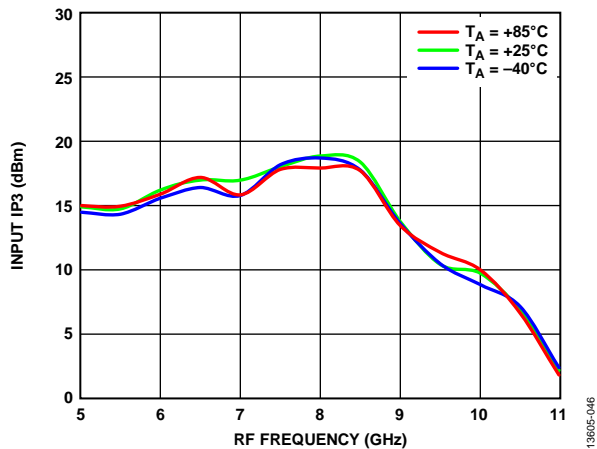

Figure 46. Input IP3 vs. RF Frequency at Various Temperatures

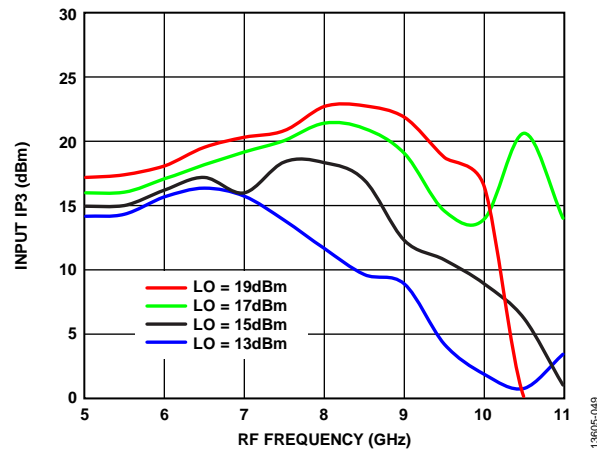

Figure 49. Input IP3 vs. RF Frequency at Various LO Powers, $T_A = 25^\circ\text{C}$

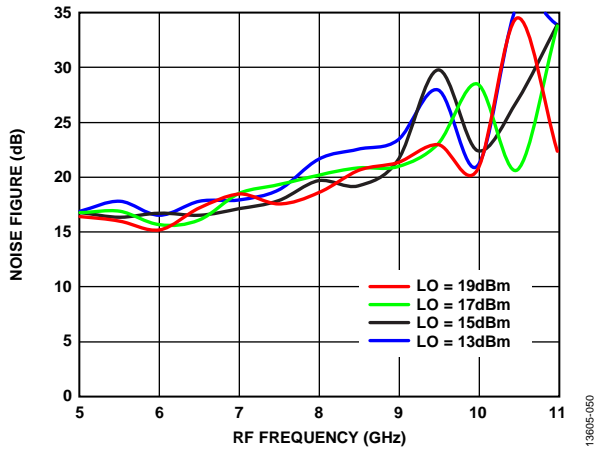

Figure 50. Noise Figure vs. RF Frequency at Various LO Powers, $T_A = 25^\circ\text{C}$

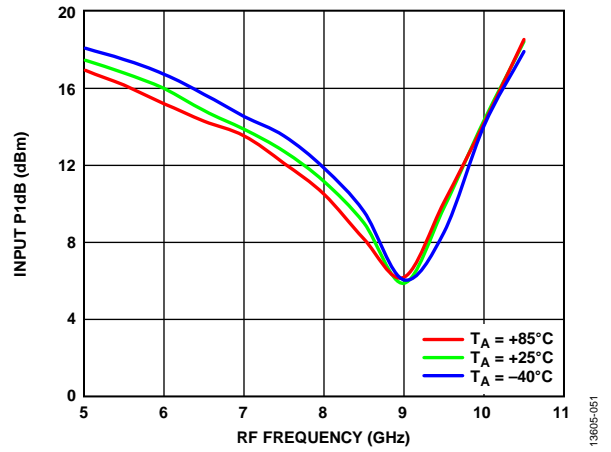

Figure 51. Input P1dB vs. RF Frequency at Various Temperatures

DOWNCONVERTER PERFORMANCE: IF = 3500 MHz, UPPER SIDEBAND (LOW-SIDE LO)

Data taken as an image reject mixer with external 90° hybrid at the IF ports, LO = 15 dBm, unless otherwise noted.

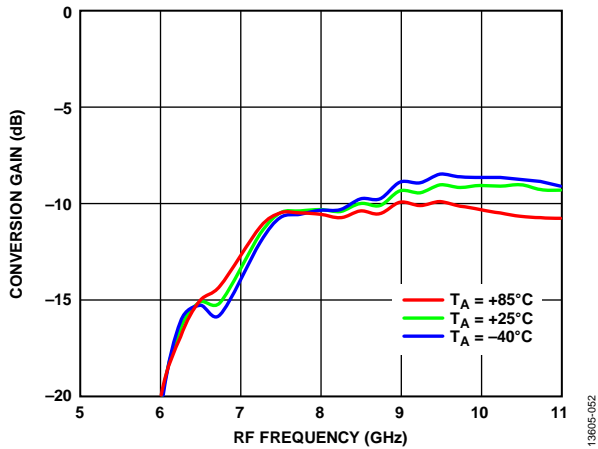

Figure 52. Conversion Gain vs. RF Frequency at Various Temperatures

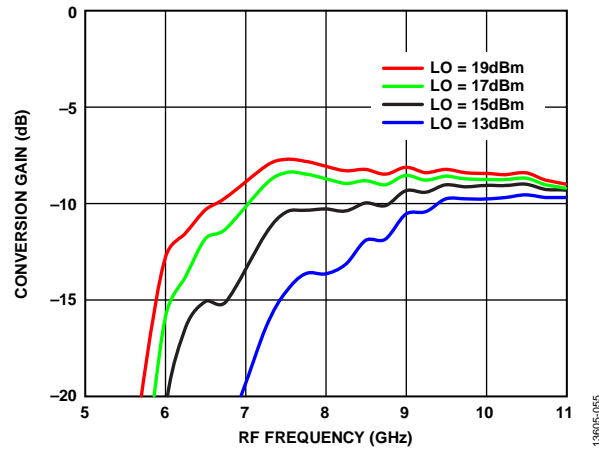

Figure 55. Conversion Gain vs. RF Frequency at Various LO Powers, $T_A = 25^\circ\text{C}$

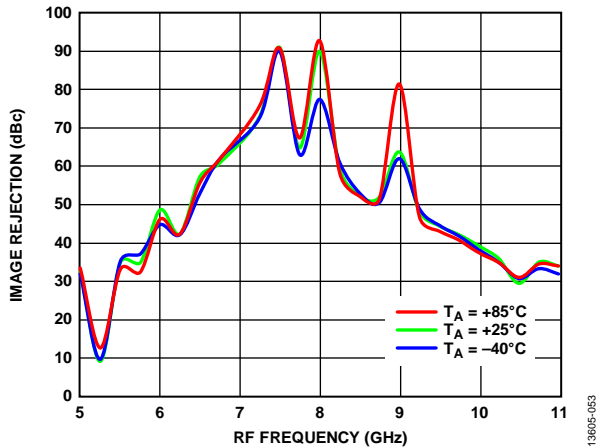

Figure 53. Image Rejection vs. RF Frequency at Various Temperatures

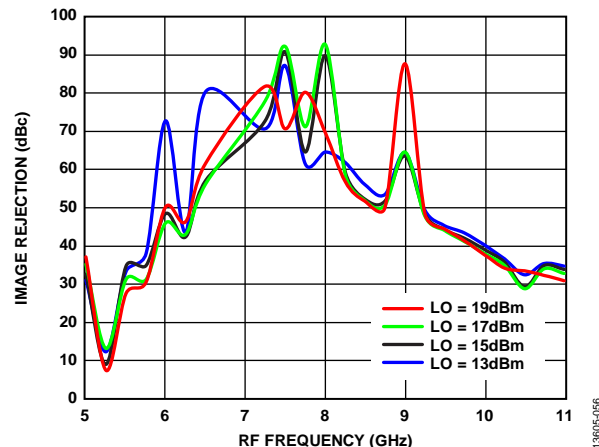

Figure 56. Image Rejection vs. RF Frequency at Various LO Powers

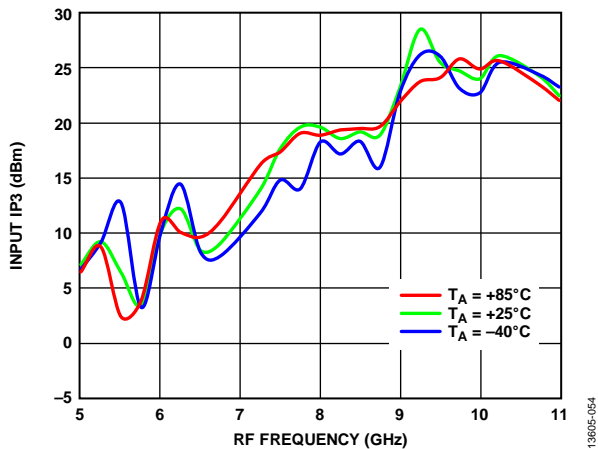

Figure 54. Input IP3 vs. RF Frequency at Various Temperatures

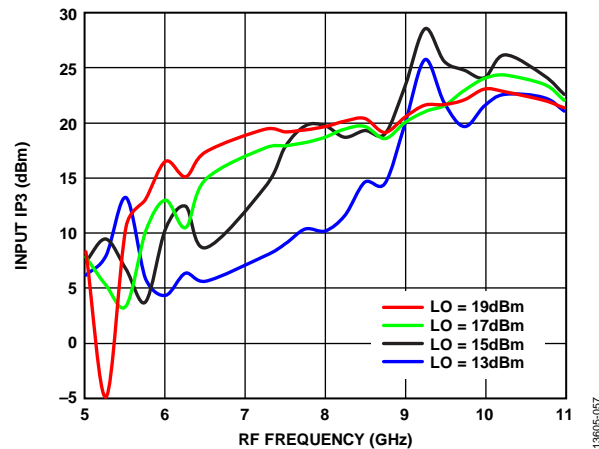

Figure 57. Input IP3 vs. RF Frequency at Various LO Powers, $T_A = 25^\circ\text{C}$

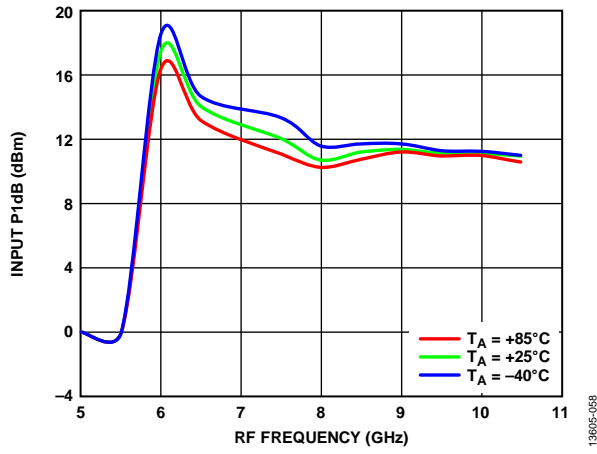

Figure 58. Input P1dB vs. RF Frequency at Various Temperatures

13805-05B

UPCONVERTER PERFORMANCE: IF INPUT FREQUENCY (IF_{IN}) = 100 MHz, LOWER SIDEBAND (HIGH-SIDE LO)

Data taken as single sideband upconverter with external 90° hybrid at the IF ports, LO = 15 dBm, unless otherwise noted.

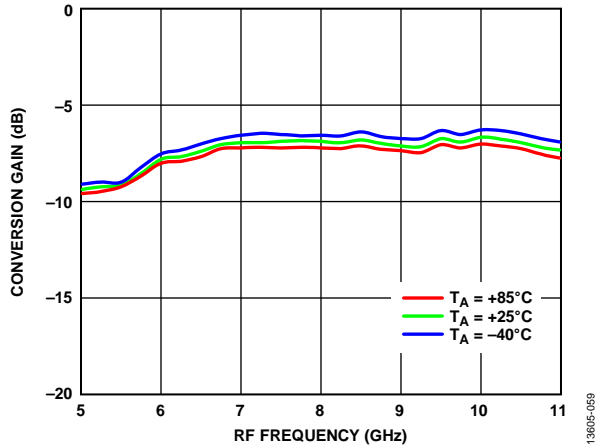

Figure 59. Conversion Gain vs. RF Frequency at Various Temperatures

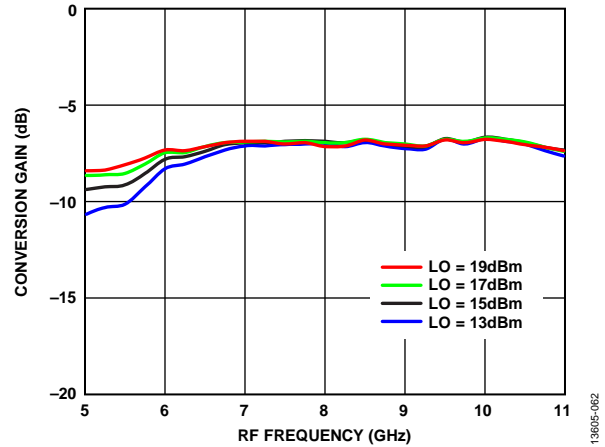

Figure 62. Conversion Gain vs. RF Frequency at Various LO Powers, $T_A = 25^\circ\text{C}$

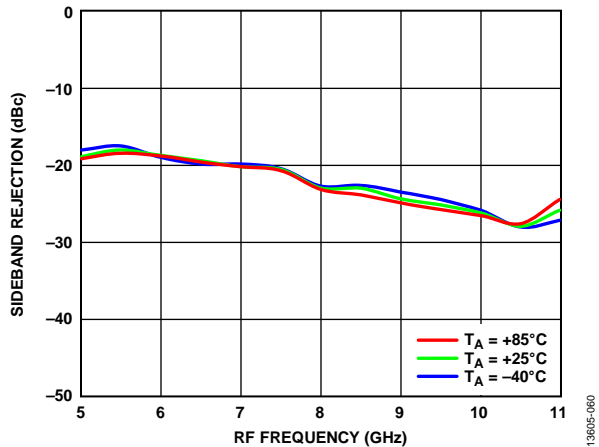

Figure 60. Sideband Rejection vs. RF Frequency at Various Temperatures

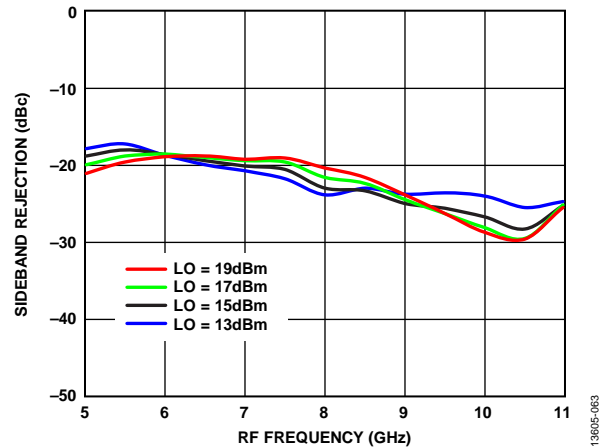

Figure 63. Sideband Rejection vs. RF Frequency at Various LO Powers, $T_A = 25^\circ\text{C}$

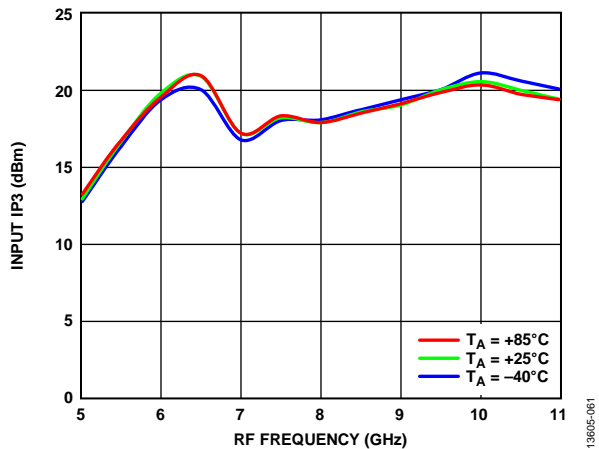

Figure 61. Input IP3 vs. RF Frequency at Various Temperature

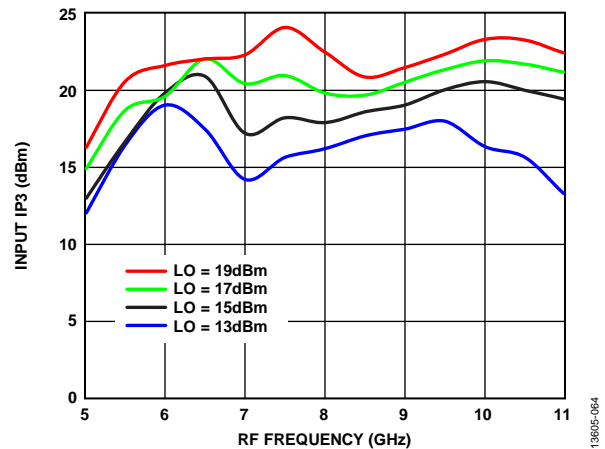

Figure 64. Input IP3 vs. RF Frequency at Various LO Powers, $T_A = 25^\circ\text{C}$

AMPLITUDE AND PHASE BALANCE DOWNCONVERTER: IF = 100 MHz, LOWER SIDEBAND (HIGH-SIDE LO)

Data taken at LO = 15 dBm, unless otherwise noted.

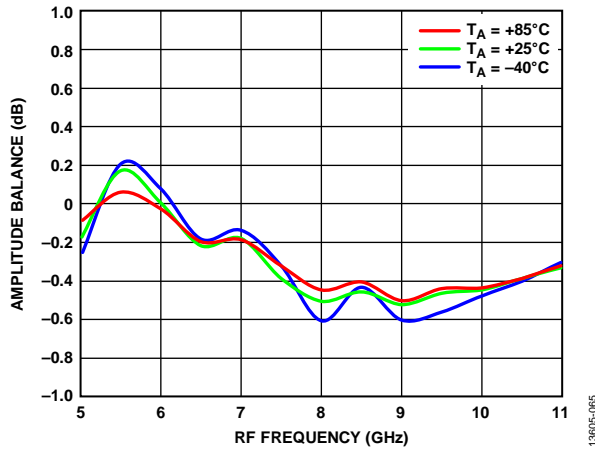

Figure 65. Amplitude Balance vs. RF Frequency at Various Temperatures

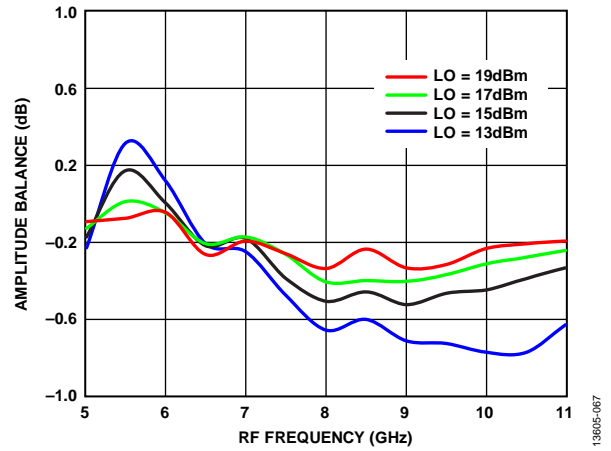

Figure 67. Amplitude Balance vs. RF Frequency at Various LO Powers, $T_A = 25^\circ\text{C}$

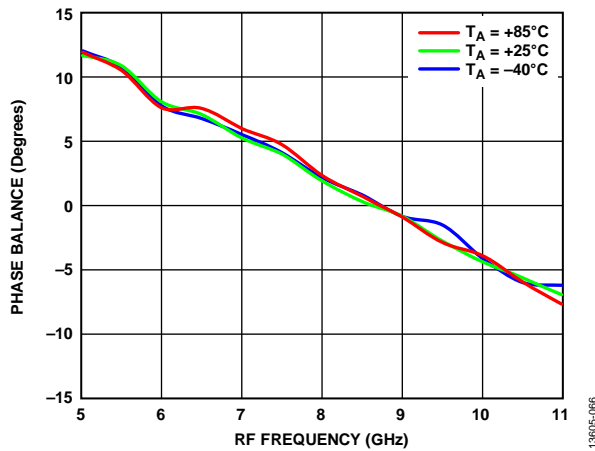

Figure 66. Phase Balance vs. RF Frequency at Various Temperatures

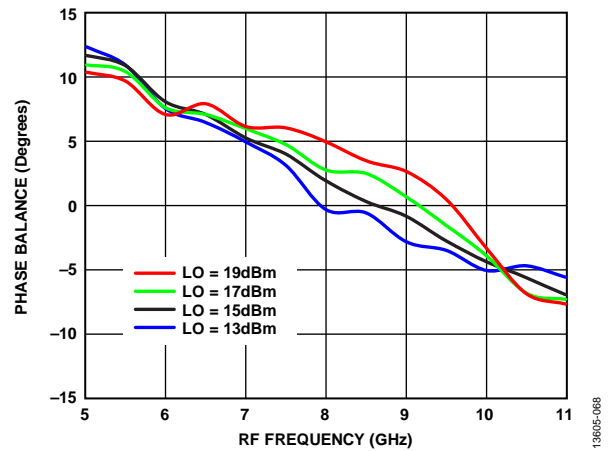

Figure 68. Phase Balance vs. RF Frequency at Various LO Powers, $T_A = 25^\circ\text{C}$

AMPLITUDE AND PHASE BALANCE DOWNCONVERTER: IF = 1500 MHz, LOWER SIDEBAND (HIGH-SIDE LO)

Data taken at LO = 15 dBm, unless otherwise noted.

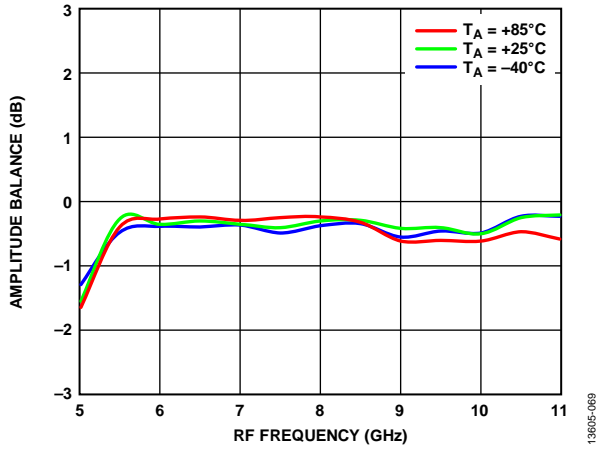

Figure 69. Amplitude Balance vs. RF Frequency at Various Temperatures

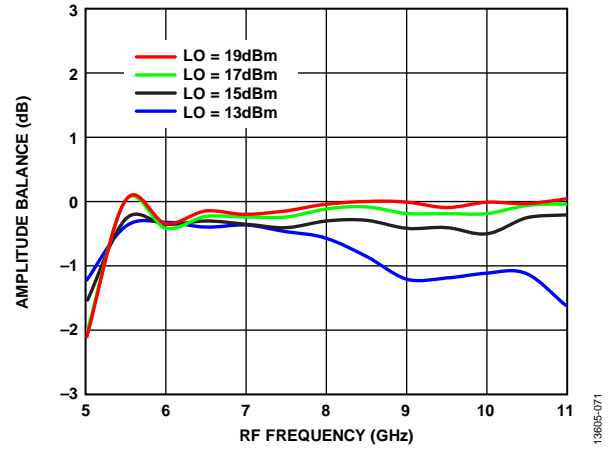

Figure 71. Amplitude Balance vs. RF Frequency at Various LO Powers, $T_A = 25^\circ\text{C}$

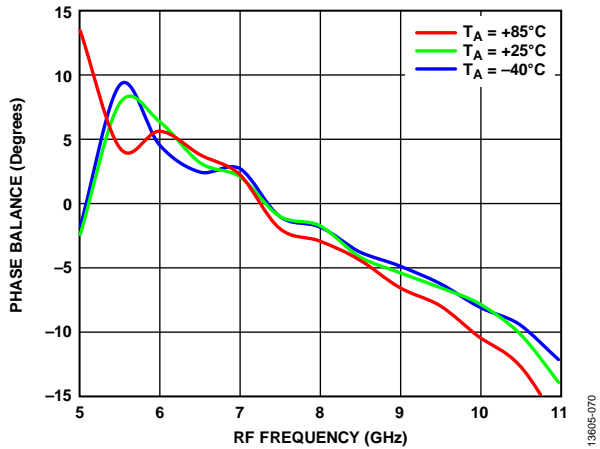

Figure 70. Phase Balance vs. RF Frequency at Various Temperatures

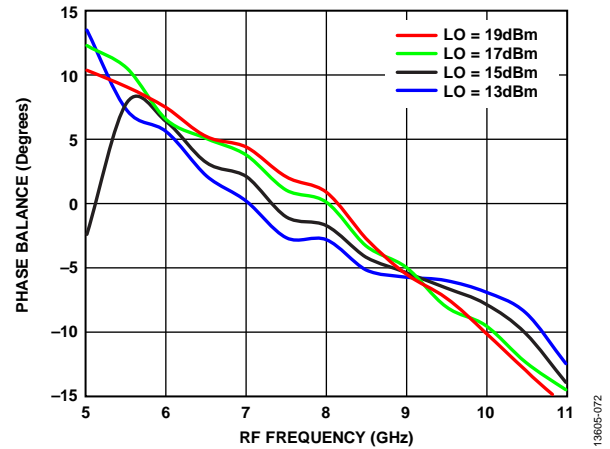

Figure 72. Phase Balance vs. RF Frequency at Various LO Powers, $T_A = 25^\circ\text{C}$

AMPLITUDE AND PHASE BALANCE DOWNCONVERTER: IF = 3500 MHz, LOWER SIDEBAND (HIGH-SIDE LO)

Data taken at LO = 15 dBm, unless otherwise noted.

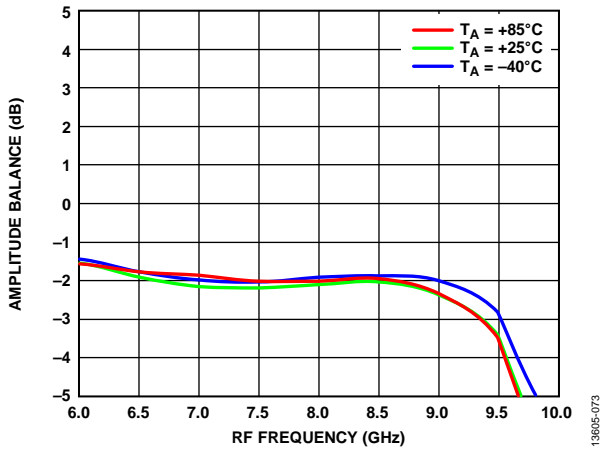

Figure 73. Amplitude Balance vs. RF Frequency at Various Temperatures

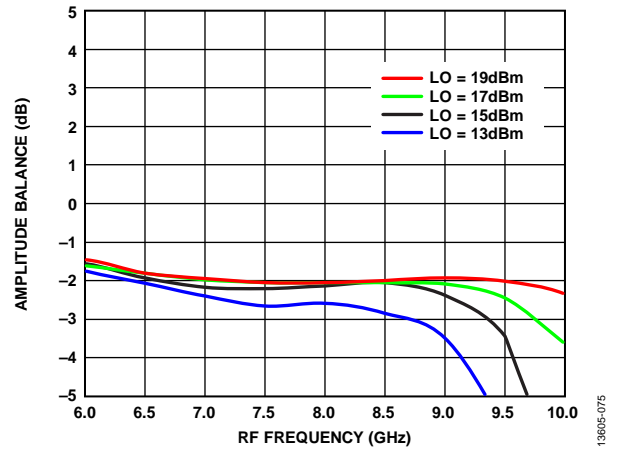

Figure 75. Amplitude Balance vs. RF Frequency at Various LO Powers, $T_A = 25^\circ\text{C}$

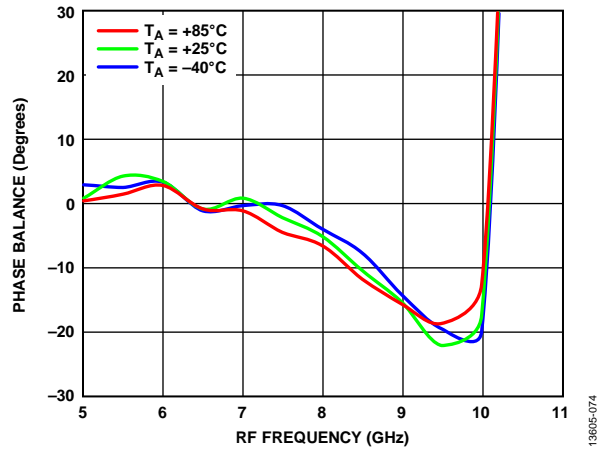

Figure 74. Phase Balance vs. RF Frequency at Various Temperatures

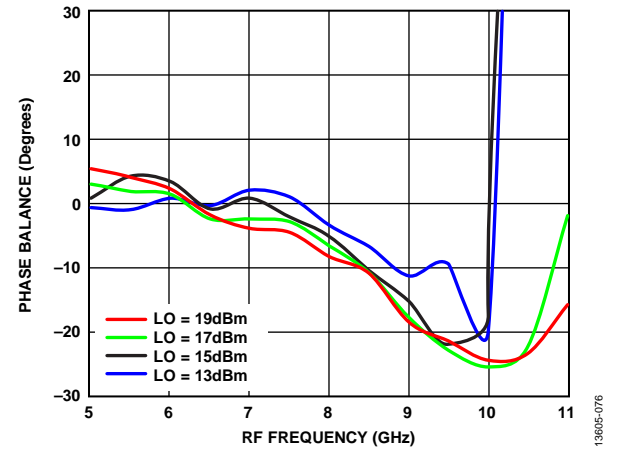

Figure 76. Phase Balance vs. RF Frequency at Various LO Powers, $T_A = 25^\circ\text{C}$

IF BANDWIDTH, DOWNCONVERTER PERFORMANCE

Data taken as an image reject mixer with an external 90° hybrid, LO = 15 dBm, unless otherwise noted.

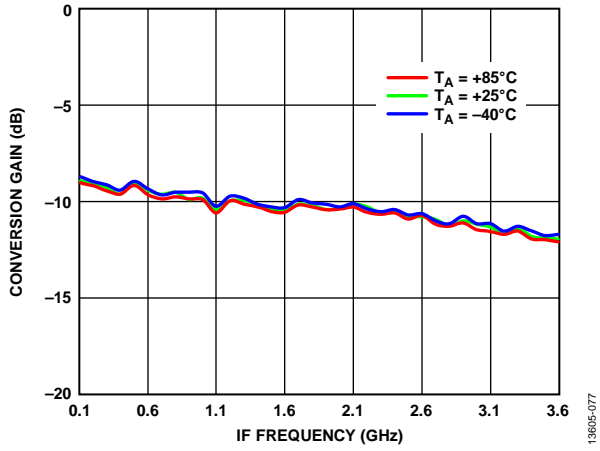

Figure 77. Conversion Gain vs. IF Frequency at Various Temperatures, Lower Sideband, LO = 10.5 GHz

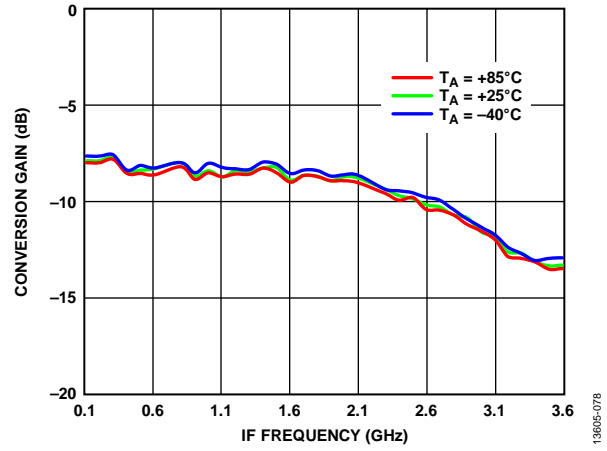

Figure 78. Conversion Gain vs. IF Frequency at Various Temperatures, Upper Sideband, LO = 8.5 GHz

ISOLATION AND RETURN LOSS

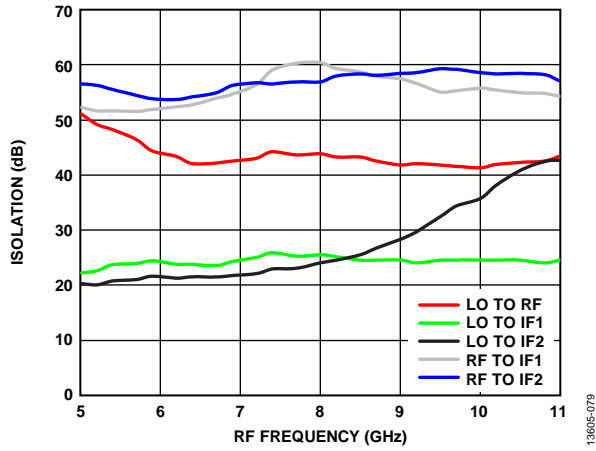

Figure 79. Isolation vs. RF Frequency at LO = 15 dBm, TA = 25°C

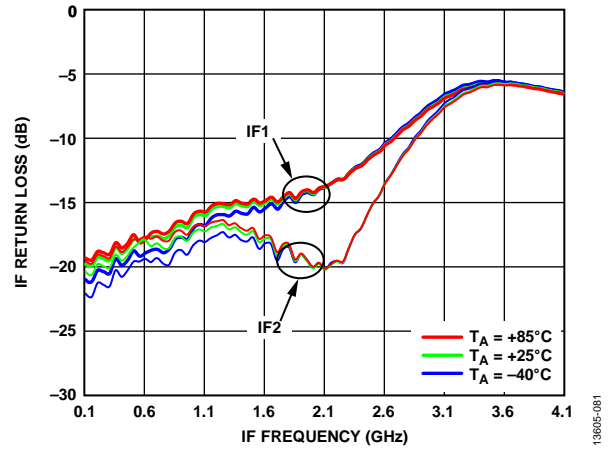

Figure 81. IF Return Loss vs. IF Frequency at Various Temperatures, LO = 8.5 GHz at 15 dBm

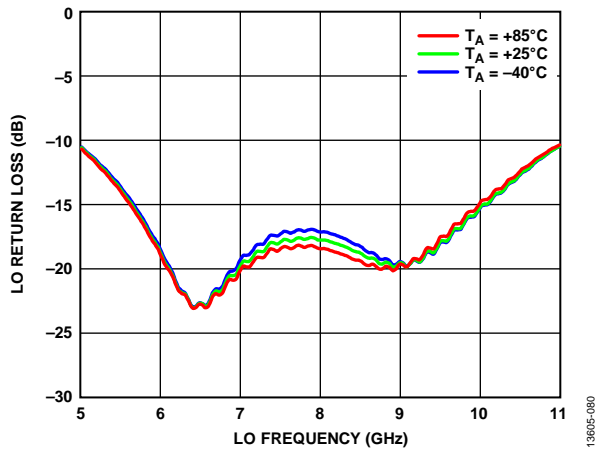

Figure 80. LO Return Loss vs. LO Frequency at Various Temperatures at LO = 15 dBm

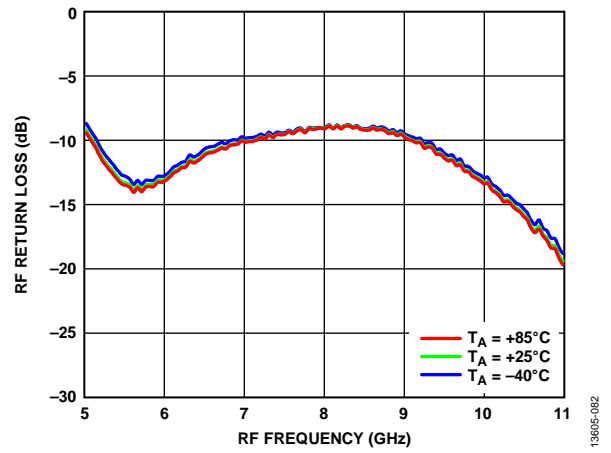

Figure 82. RF Return Loss vs. RF Frequency at Various Temperatures, LO = 8.5 GHz at 15 dBm

SPURIOUS AND HARMONICS PERFORMANCE

LO harmonic isolation, LO = 15 dBm, all values are in dBc measured below the input LO level at the RF port and are positive, unless otherwise noted.

Table 5. N_{LO} Spur at RF Output (RF_{OUT})

LO Frequency (GHz)	N × LO			
	1	2	3	4
5.5	49	33	52	66
6.5	43	37	63	52
7	43	43	55	55
7.5	44	55	52	61
8.5	43	59	69	62
9.5	42	61	62	65
10.5	42	72	56	61

M × N Spurious Output Performance, Downconverter, Lower Sideband (High-Side LO), IF = 100 MHz, T_A = 25°C

RF = 9400 MHz at -10 dBm, LO = 9500 MHz at 15 dBm, data taken without external hybrid, and all values are in dBc measured below the IF power level (M × RF) - (N × LO) and are positive, unless otherwise noted.

		N × LO					
		0	1	2	3	4	5
M × RF	0	0	-13	+31	+12	+39	+56
	1	+31	0	+42	+60	+62	+50
	2	+71	+57	+66	+58	+70	+60
	3	+69	+70	+75	+67	+74	+71
	4	+62	+68	+71	+75	+85	+74
	5	+58	+61	+67	+71	+77	+85

M × N Spurious Output Performance, Downconverter, Upper Sideband (Low-Side LO), IF = 100 MHz, T_A = 25°C

RF = 7600 MHz at -10 dBm, LO = 7500 MHz at 15 dBm, data taken without external hybrid, and all values are in dBc measured below the IF power level (M × RF) - (N × LO) and are positive, unless otherwise noted.

		N × LO					
		0	1	2	3	4	5
M × RF	0	0	-10	+23	+29	+46	+35
	1	+31	0	+36	+49	+68	+53
	2	+73	+51	+76	+50	+75	+65
	3	+68	+74	+78	+72	+78	+73
	4	+68	+71	+71	+79	+87	+77
	5	+62	+68	+70	+73	+77	+86

M × N Spurious Output Performance, Upconverter, Upper Sideband (Low-Side LO), IF_{IN} = 100 MHz at -10 dBm, T_A = 25°C

RF_{OUT} = 7600 MHz, LO = 7500 MHz at 15 dBm, data taken without external hybrid, and all values are in dBc measured below the RF_{OUT} power level (M × IF_{IN}) - (N × LO) and are positive, unless otherwise noted.

		N × LO					
		0	1	2	3	4	5
M × IF	0	0	6	26	24	29	42
	1	78	0	24	30	56	42
	2	89	53	71	67	62	58
	3	88	65	73	67	64	60
	4	88	76	71	66	64	58
	5	86	77	72	68	63	59

M × N Spurious Output Performance, Upconverter, Lower Sideband (High-Side LO), IF_{IN} = 100 MHz at -10 dBm, T_A = 25°C

RF_{OUT} = 9400 MHz, LO = 9500 MHz at 15 dBm, data taken without external hybrid, and all values are in dBc measured below the RF_{OUT} power level (M × IF_{IN}) - (N × LO) and are positive, unless otherwise noted.

		N × LO					
		0	1	2	3	4	5
M × IF	0	0	8	21	17	26	35
	1	79	0	25	48	54	37
	2	87	55	47	57	56	59
	3	87	60	74	72	68	61
	4	86	77	73	72	66	61
	5	86	78	74	72	67	60

THEORY OF OPERATION

The [HMC520A](#) is a GaAs, MMIC, I/Q mixer in a 24-terminal, RoHS compliant, ceramic LCC package and operates over the -40°C to $+85^{\circ}\text{C}$ temperature range. The [EV1HMC520ALC4](#) evaluation board is also available from Analog Devices, Inc. The [HMC520A](#) is a passive, wideband, I/Q MMIC mixer that can be used as either an image reject mixer for receiver operations or as a single sideband upconverter for transmitter operations. The mixer uses two standard double balanced mixer cells and a 90° hybrid fabricated in the GaAs, MESFET process.

With an RF and an LO input frequency range of 6 GHz to 10 GHz and an IF frequency range of dc to 3.5 GHz, the [HMC520A](#) is ideal for applications requiring a wide frequency range, excellent RF performance, a simple design with fewer components, and a small PCB footprint. One [HMC520A](#) can replace multiple narrow-band mixers in a design. The [HMC520A](#) eliminates the

need for wire bonding, allowing the use of the surface-mount manufacturing techniques.

The inherent I/Q architecture of the [HMC520A](#) offers excellent image rejection and thereby eliminates the need for expensive filtering for unwanted sidebands. The double balanced architecture of the mixer also provides excellent LO to RF isolation and LO to IF isolation, and this architecture reduces the effect of LO leakage to ensure signal integrity. Because the [HMC520A](#) is a passive mixer, the [HMC520A](#) does not require any dc power sources. The [HMC520A](#) offers a lower noise figure compared to an active mixer, ensuring superior dynamic range for high performance and precision applications.

For both upconversion and downconversion, an external 90° hybrid is required. See the Applications Information section for details on interfacing with this external 90° hybrid.

APPLICATIONS INFORMATION

Figure 83 shows the typical application circuit for the HMC520A. To select the appropriate sideband, an external 90° hybrid is needed. For applications not requiring operation to dc, use an off chip dc blocking capacitor. For applications that require the LO signal at the output to be suppressed, use a bias tee or RF feed as shown in Figure 83. Ensure that the source or sink current used for LO suppression is <12 mA for each IF port to prevent damage to the device. The common-mode voltage for each IF port is 0 V.

To select the upper sideband when using as an upconverter, connect the IF1 pin to the 90° port of the hybrid and connect the IF2 pin to the 0° port of the hybrid. To select the lower sideband, connect the IF1 pin to the 0° port of the hybrid and connect the IF2 pin to the 90° port of the hybrid. The input is from the sum port of the hybrid, and the difference port is 50 Ω terminated.

To select the upper sideband (low-side LO) when using as a downconverter, connect the IF1 pin to the 0° port of the hybrid and connect the IF2 pin to the 90° port of the hybrid. To select the lower sideband (high-side LO), connect the IF1 pin to the 90° port of the hybrid and connect the IF2 pin to the 0° port of the hybrid. The output is from the sum port of the hybrid, and the difference port is 50 Ω terminated.

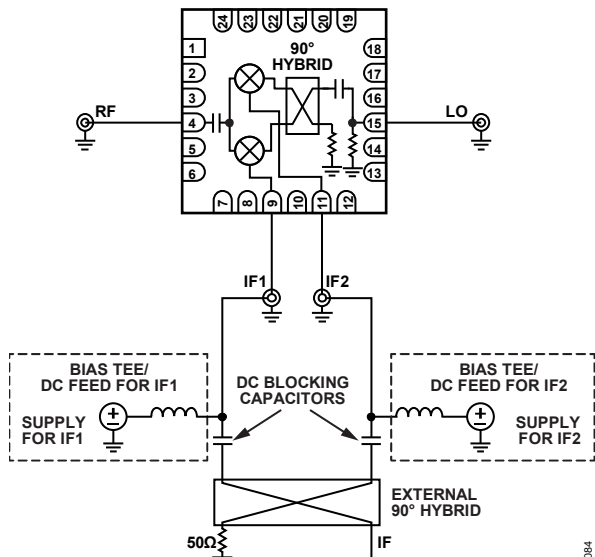

NOTES
1. DASHED SECTIONS ARE OPTIONAL AND MEANT FOR LO NULLING.

Figure 83. Typical Application Circuit

PERFORMANCE TO 13 GHz

This section provides test results at a higher frequency to 13 GHz. Board, traces, and connector losses are not de-embedded for all measurements. This performance is typical, though not guaranteed. All measurements were made under the following conditions: LO = 15 dBm, IF = 1.5 GHz, RF = -10 dBm, and T_A = 25°C, with an external 90° IF hybrid at the IF ports, unless otherwise noted.

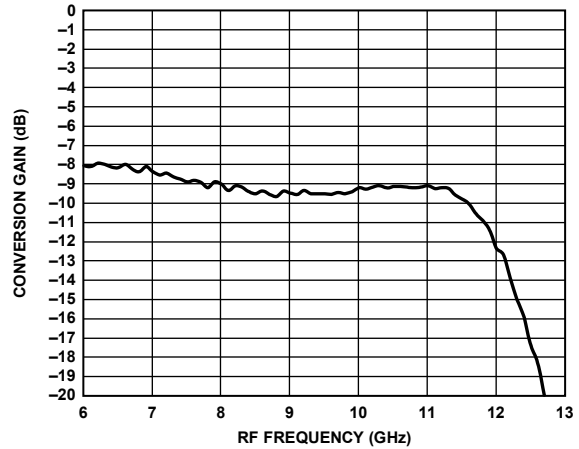

Figure 84. Conversion Gain vs. RF Frequency, Downconverter, Lower Sideband (High-Side LO), IF = 1.5 GHz

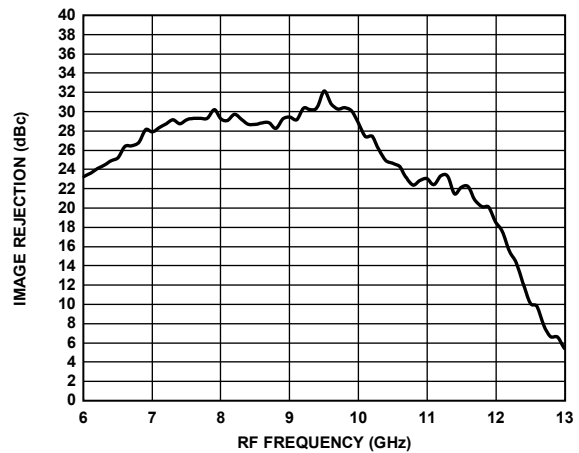

Figure 85. Image Rejection vs. RF Frequency, Downconverter, Lower Sideband (High-Side LO), IF = 1.5 GHz

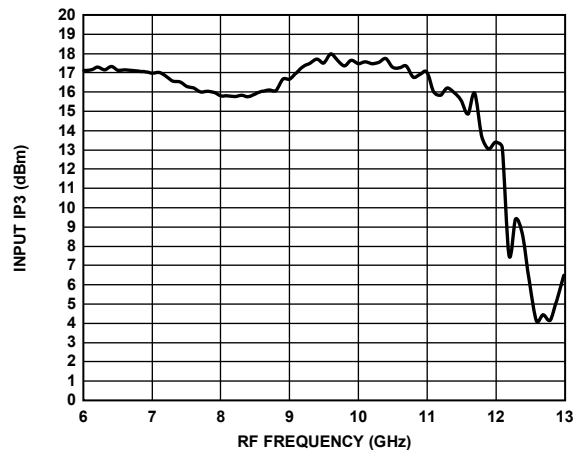

Figure 86. Input IP3 vs. RF Frequency, Downconverter, Lower Sideband (High-Side LO), IF = 1.5 GHz

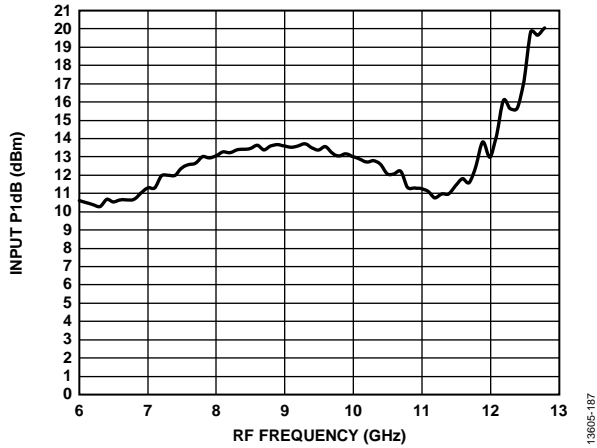

Figure 87. Input P1dB vs. RF Frequency, Downconverter, Lower Sideband (High-Side LO), IF = 1.5 GHz

13605-187

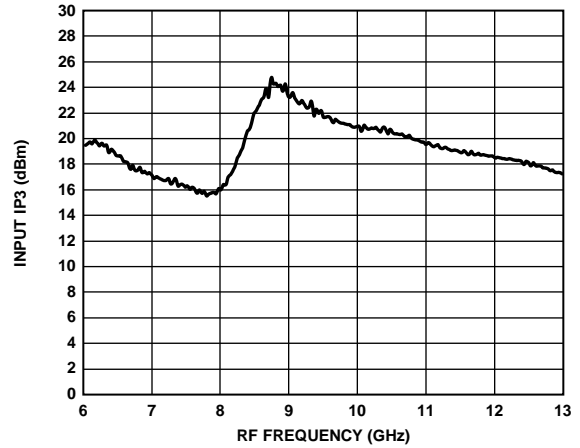

Figure 90. Input IP3 vs. RF Frequency, Downconverter, Upper Sideband (High-Side LO), IF = 1.5 GHz

13605-190

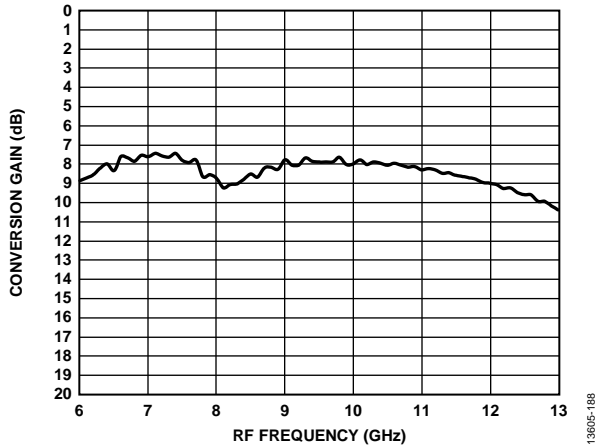

Figure 88. Conversion Gain vs. RF Frequency, Downconverter, Upper Sideband (High-Side LO), IF = 1.5 GHz

13605-188

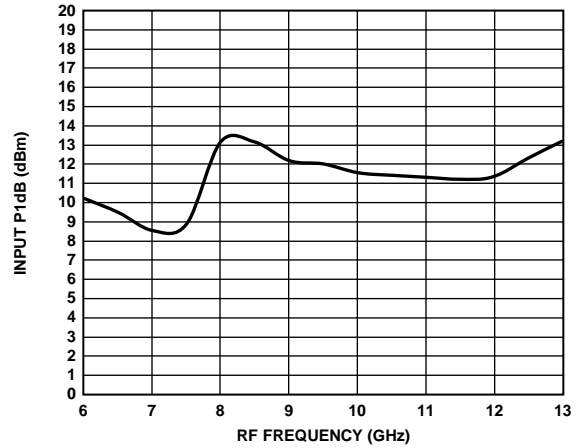

Figure 91. Input P1dB vs. RF Frequency, Downconverter, Upper Sideband (High-Side LO), IF = 1.5 GHz

13605-191

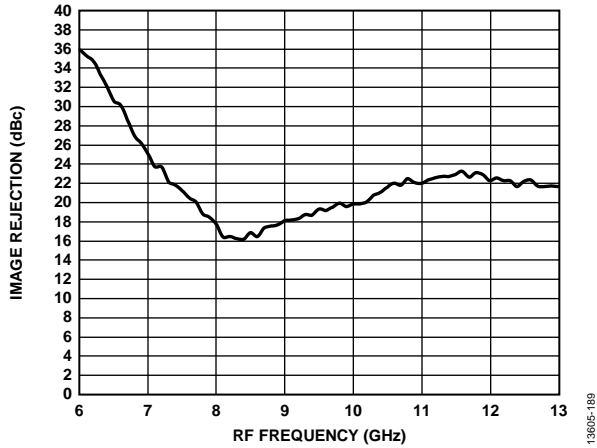

Figure 89. Image Rejection vs. RF Frequency, Downconverter, Upper Sideband (High-Side LO), IF = 1.5 GHz

13605-189

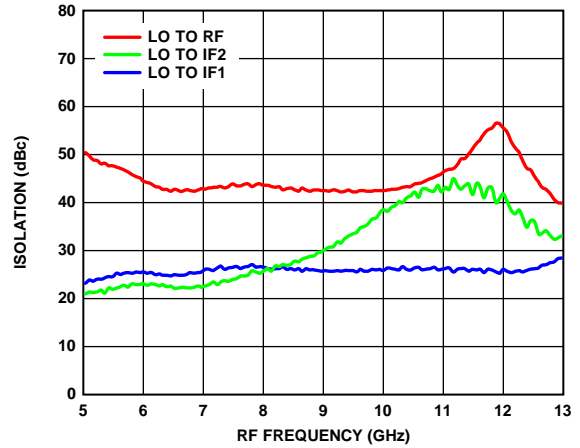

Figure 92. Isolation vs. RF Frequency, LO to RF and LO to IFx

13605-192

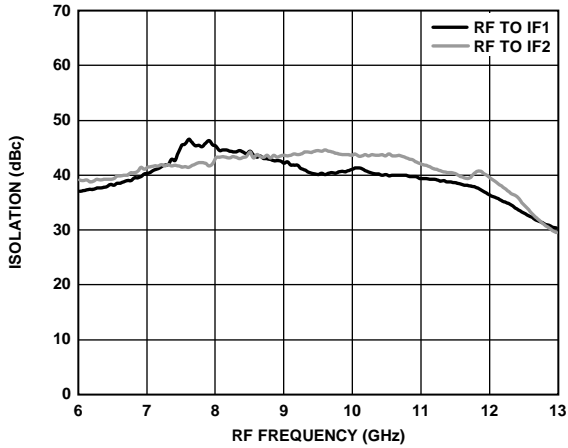

Figure 93. Isolation vs. RF Frequency, RF to INx

13605-193

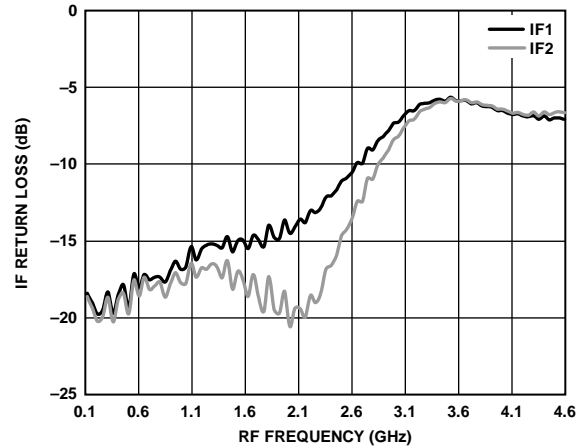

Figure 96. IF Return Loss vs. RF Frequency

13605-196

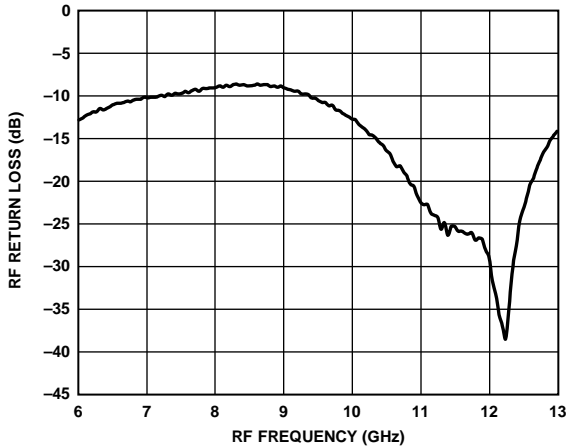

Figure 94. RF Return Loss vs. RF Frequency

13605-194

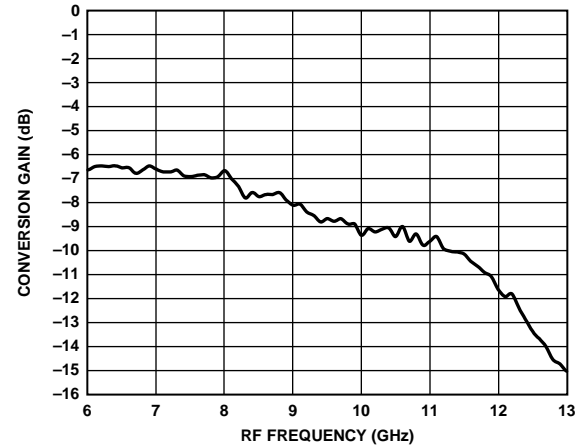

Figure 97. Conversion Gain vs. RF Frequency, Upconverter, Lower Sideband, IF = 1.5 GHz, LO Drive = 15 dBm

13605-197

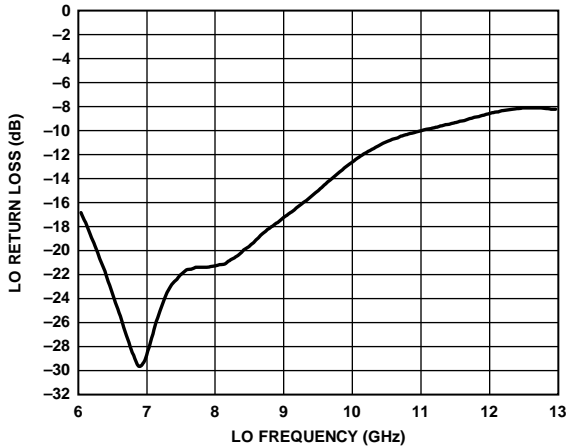

Figure 95. LO Return Loss vs. RF Frequency

13605-195

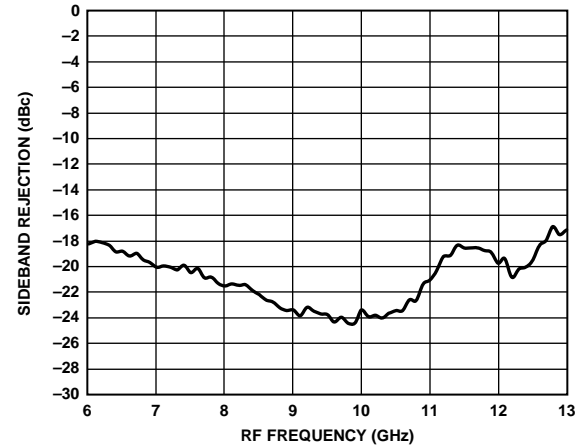

Figure 98. Sideband Rejection vs. RF Frequency, Upconverter, Lower Sideband, IF = 1.5 GHz, LO Drive = 15 dBm

13605-198

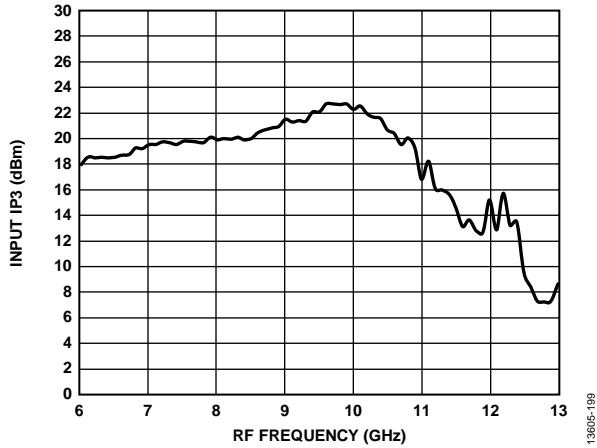

Figure 99. Input IP3 vs. RF Frequency, Upconverter, Lower Sideband, IF = 1.5 GHz, LO Drive = 15 dBm

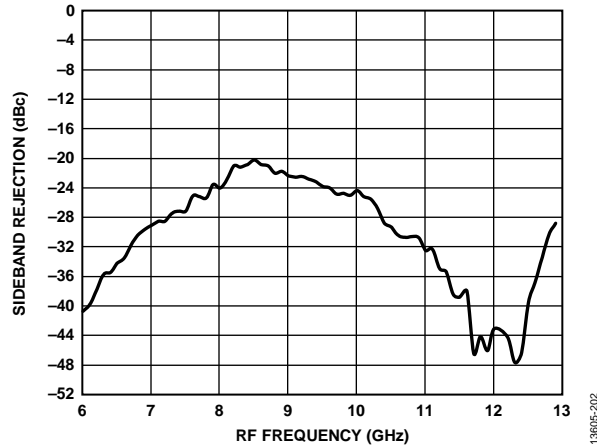

Figure 102. Sideband Rejection vs. RF Frequency, Upconverter, Upper Sideband, IF = 1.5 GHz, LO Drive = 15 dBm

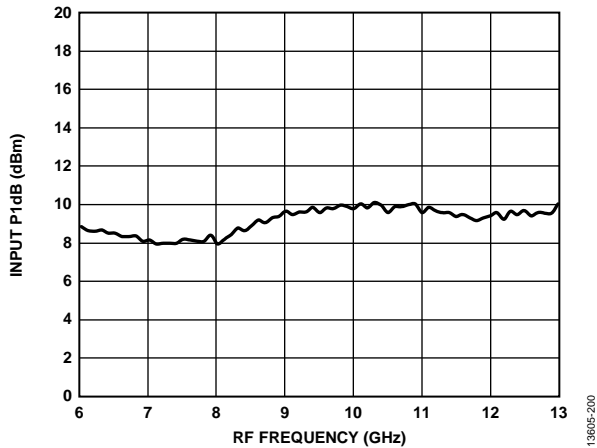

Figure 100. Input P1dB vs. RF Frequency, Upconverter, Lower Sideband, IF = 1.5 GHz, LO Drive = 15 dBm

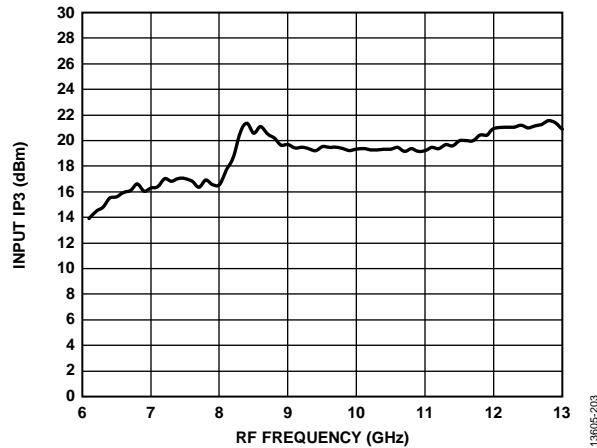

Figure 103. Input IP3 vs. RF Frequency, Upconverter, Upper Sideband, IF = 1.5 GHz, LO Drive = 15 dBm

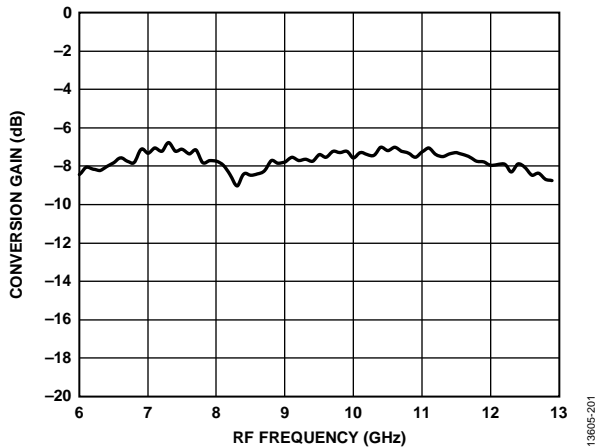

Figure 101. Conversion Gain vs. RF Frequency, Upconverter, Upper Sideband, IF = 1.5 GHz, LO Drive = 15 dBm

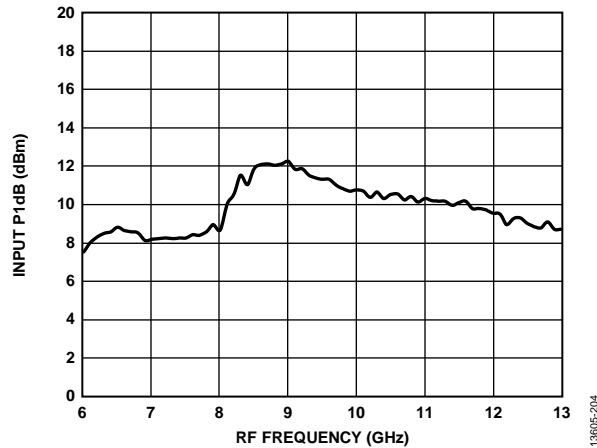

Figure 104. Input P1dB vs. RF Frequency, Upconverter, Upper Sideband, IF = 1.5 GHz, LO Drive = 15 dBm

SOLDERING INFORMATION AND RECOMMENDED LAND PATTERN

Figure 105 shows the recommended land pattern for the HMC520A. The HMC520A is contained in a 24-terminal ceramic LCC package, which has an exposed ground pad. This pad is internally connected to the ground of the chip.

To minimize thermal impedance and ensure electrical performance, solder the pad to the low impedance ground plane on the PCB. To further reduce thermal impedance, stitch the ground planes together on all layers under the pad with vias.

The land pattern on the EV1HMC520ALC4 evaluation board provides a simulated thermal resistance (θ_{jc}) of 225°C/W.

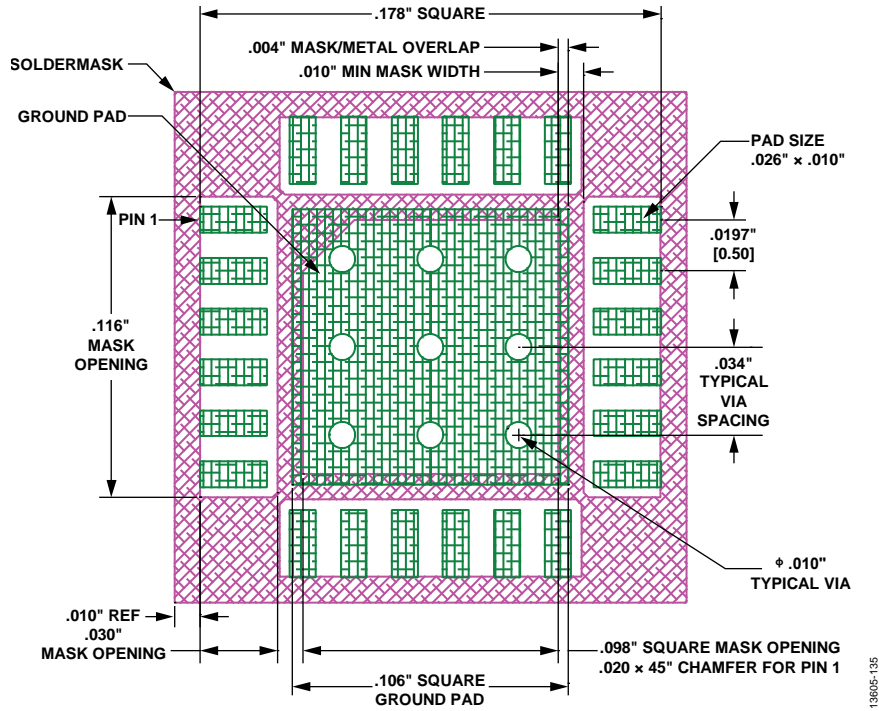

Figure 105. Evaluation Board Land Pattern

EVALUATION BOARD INFORMATION

The [EV1HMC520ALC4](#) evaluation PCB used in the application must use RF circuit design techniques. Signal lines must have 50 Ω impedance and connect the package ground leads and exposed pad directly to the ground plane (see Figure 106). Use a

sufficient number of via holes to connect the top and bottom ground planes. The evaluation circuit board shown in Figure 106 is available from Analog Devices upon request.

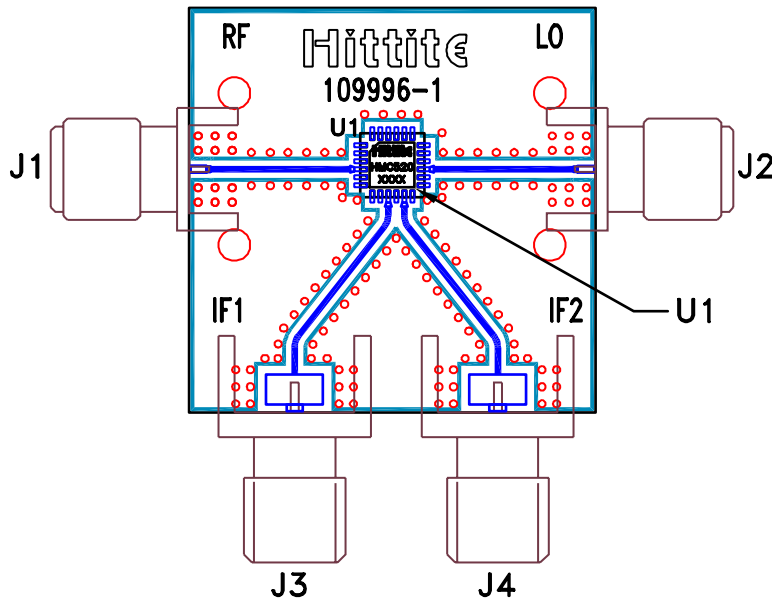

Figure 106. [EV1HMC520ALC4](#) Evaluation PCB Top Layer

13695-085

Table 6. Bill of Materials for the [EV1HMC520ALC4](#) Evaluation PCB

Quantity	Reference Designator	Description	Part Number
1	109996-1	PCB, EV1HMC520ALC4 ^{1,2}	109996-1
2	J1, J2 (RF, LO)	2.92 mm Johnson SubMiniature Version A (SMA) connectors, SRI Connector Gage	104935
2	J3, J4 (IF1, IF2)	Gold plated SMA, edge mount with 0.02 inch pin connectors, SMA connectors	105192
1	U1	Device under test, HMC520ALC4	HMC520ALC4

¹Reference this number when ordering the evaluation board PCB.

² Circuit Board Material: RO4350B™.

OUTLINE DIMENSIONS

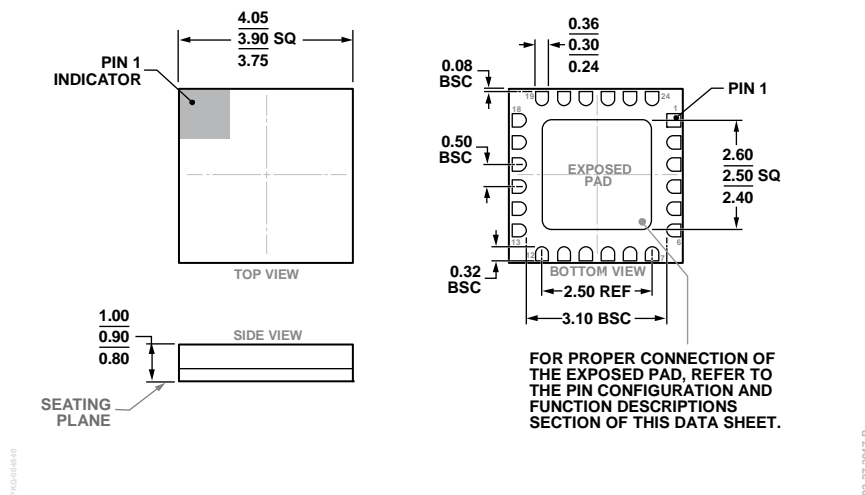

Figure 107. 24-Terminal Ceramic Leadless Chip Carrier [LCC] (E-24-1)
Dimensions shown in millimeters

ORDERING GUIDE

Model ¹	Temperature Range	Package Description	Package Option
HMC520ALC4	-40°C to +85°C	24-Terminal Ceramic Leadless Chip Carrier [LCC]	E-24-1
HMC520ALC4TR	-40°C to +85°C	24-Terminal Ceramic Leadless Chip Carrier [LCC]	E-24-1
HMC520ALC4TR-R5	-40°C to +85°C	24-Terminal Ceramic Leadless Chip Carrier [LCC]	E-24-1
EV1HMC520ALC4		Evaluation Board	

¹ The HMC520ALC4, the HMC520ALC4TR, and the HMC520ALC4TR-R5 are RoHS compliant parts.