

# 800 mA Low-Dropout Linear Regulator

## LM1117, LM1117I

The LM1117 is a low dropout voltage regulator with a dropout of 1.2 V at 800 mA of load current. The LM1117 is available in an adjustable version, which can set the output voltage from 1.25 to 13.8 V with only two external resistors. In addition, it is available in five fixed voltages, 1.8 V, 2.5 V, 3.3 V, and 5 V.

The LM1117 offers current limiting and thermal shutdown. Its circuit is trimmed to assure output voltage accuracy to within  $\pm 1\%$ .

### Features

- Available in 1.8 V, 2.5 V, 3.3 V, 5.0 V, and Adjustable Versions
- Space-Saving SOT-223 Package
- Current Limiting and Thermal Protection
- Output Current 800 mA
- Line Regulation 0.2% (Maximum)
- Load Regulation 0.4% (Maximum)
- Temperature Range:  $-40^{\circ}\text{C}$  to  $125^{\circ}\text{C}$
- These are Pb-Free Devices

### Applications

- Post Regulator for Switching DC-DC Converter
- High Efficiency Linear Regulators
- Battery Chargers
- Portable Instrumentation
- Active SCSI Termination Regulation



**ON Semiconductor®**

[www.onsemi.com](http://www.onsemi.com)



**SOT-223  
CASE 318H**

### PIN CONFIGURATION



**SOT-223  
(Top View)**

- Pin: 1. Adjust/Ground  
2. Output  
3. Input

Heatsink tab is connected to Pin 2.

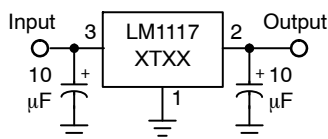
### ORDERING INFORMATION

See detailed ordering and shipping information in the package dimensions section on page 11 of this data sheet.

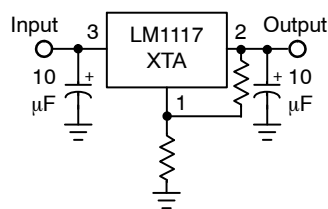
### DEVICE MARKING INFORMATION

See general marking information in the device marking section on page 11 of this data sheet.

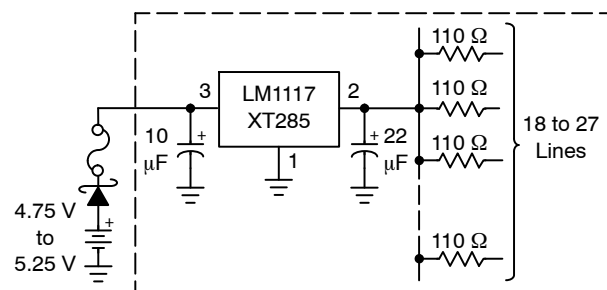
### TYPICAL APPLICATIONS



**Figure 1. Fixed Output Regulator**



**Figure 2. Adjustable Output Regulator**



**Figure 3. Active SCSI Bus Terminator**

# LM1117, LM1117I

## MAXIMUM RATINGS

Rating	Symbol	Value	Unit
Input Voltage (Note 1)	$V_{in}$	20	V
Output Short Circuit Duration (Notes 2 and 3)	–	Infinite	–
Power Dissipation and Thermal Characteristics Case 318H (SOT–223) Power Dissipation (Note 2) Thermal Resistance, Junction–to–Ambient, Minimum Size Pad Thermal Resistance, Junction–to–Case	$P_D$ $R_{\theta JA}$ $R_{\theta JC}$	Internally Limited 160 15	W °C/W °C/W
Maximum Die Junction Temperature Range	$T_J$	–55 to 150	°C
Storage Temperature Range	$T_{stg}$	–65 to 150	°C
Operating Ambient Temperature Range LM1117 LM1117I	$T_A$	0 to +125 –40 to +125	°C

Stresses exceeding those listed in the Maximum Ratings table may damage the device. If any of these limits are exceeded, device functionality should not be assumed, damage may occur and reliability may be affected.

- This device series contains ESD protection and exceeds the following tests:  
Human Body Model (HBM), Class 2, 2000 V  
Machine Model (MM), Class B, 200 V  
Charge Device Model (CDM), Class IV, 2000 V.
- Internal thermal shutdown protection limits the die temperature to approximately 175°C. Proper heatsinking is required to prevent activation. The maximum package power dissipation is:  

$$P_D = \frac{T_{J(max)} - T_A}{R_{\theta JA}}$$
- The regulator output current must not exceed 1.0 A with  $V_{in}$  greater than 12 V.

# LM1117, LM1117I

## ELECTRICAL CHARACTERISTICS

( $C_{in} = 10 \mu\text{F}$ ,  $C_{out} = 10 \mu\text{F}$ , for typical value  $T_A = 25^\circ\text{C}$ , for min and max values  $T_A$  is the operating ambient temperature range that applies unless otherwise noted.) (Note 4)

Characteristic	Symbol	Min	Typ	Max	Unit
Reference Voltage, Adjustable Output Devices ( $V_{in}-V_{out} = 2.0 \text{ V}$ , $I_{out} = 10 \text{ mA}$ , $T_A = 25^\circ\text{C}$ ) ( $V_{in}-V_{out} = 1.4 \text{ V to } 10 \text{ V}$ , $I_{out} = 10 \text{ mA to } 800 \text{ mA}$ ) (Note 4)	$V_{ref}$	1.238 1.225	1.25 –	1.262 1.270	V
Output Voltage, Fixed Output Devices 1.8 V ( $V_{in} = 3.8 \text{ V}$ , $I_{out} = 10 \text{ mA}$ , $T_A = 25^\circ\text{C}$ ) ( $V_{in} = 3.2 \text{ V to } 11.8 \text{ V}$ , $I_{out} = 0 \text{ mA to } 800 \text{ mA}$ ) (Note 4)  2.5 V ( $V_{in} = 4.5 \text{ V}$ , $I_{out} = 10 \text{ mA}$ , $T_A = 25^\circ\text{C}$ ) ( $V_{in} = 3.9 \text{ V to } 10 \text{ V}$ , $I_{out} = 0 \text{ mA to } 800 \text{ mA}$ ,) (Note 4)  3.3 V ( $V_{in} = 5.3 \text{ V}$ , $I_{out} = 10 \text{ mA}$ , $T_A = 25^\circ\text{C}$ ) ( $V_{in} = 4.75 \text{ V to } 10 \text{ V}$ , $I_{out} = 0 \text{ mA to } 800 \text{ mA}$ ) (Note 4)  5.0 V ( $V_{in} = 7.0 \text{ V}$ , $I_{out} = 10 \text{ mA}$ , $T_A = 25^\circ\text{C}$ ) ( $V_{in} = 6.5 \text{ V to } 12 \text{ V}$ , $I_{out} = 0 \text{ mA to } 800 \text{ mA}$ ) (Note 4)	$V_{out}$	1.782 1.755  2.475 2.450  3.267 3.235  4.950 4.900	1.800 –  2.500 –  3.300 –  5.000 –	1.818 1.845  2.525 2.550  3.333 3.365  5.050 5.100	V
Line Regulation (Note 5)      Adjustable ( $V_{in} = 2.75 \text{ V to } 16.25 \text{ V}$ , $I_{out} = 10 \text{ mA}$ )  1.8 V ( $V_{in} = 3.2 \text{ V to } 11.8 \text{ V}$ , $I_{out} = 0 \text{ mA}$ ) 2.5 V ( $V_{in} = 3.9 \text{ V to } 10 \text{ V}$ , $I_{out} = 0 \text{ mA}$ ) 3.3 V ( $V_{in} = 4.75 \text{ V to } 15 \text{ V}$ , $I_{out} = 0 \text{ mA}$ ) 5.0 V ( $V_{in} = 6.5 \text{ V to } 15 \text{ V}$ , $I_{out} = 0 \text{ mA}$ )	$Reg_{line}$	– – – –	0.04 0.4 0.5 0.8 0.9	0.1 1.0 2.5 4.5 6.0	% mV
Load Regulation (Note 5)      Adjustable ( $I_{out} = 10 \text{ mA to } 800 \text{ mA}$ , $V_{in} = 4.25 \text{ V}$ )  1.8 V ( $I_{out} = 0 \text{ mA to } 800 \text{ mA}$ , $V_{in} = 3.2 \text{ V}$ ) 2.5 V ( $I_{out} = 0 \text{ mA to } 800 \text{ mA}$ , $V_{in} = 3.9 \text{ V}$ ) 3.3 V ( $I_{out} = 0 \text{ mA to } 800 \text{ mA}$ , $V_{in} = 4.75 \text{ V}$ ) 5.0 V ( $I_{out} = 0 \text{ mA to } 800 \text{ mA}$ , $V_{in} = 6.5 \text{ V}$ )	$Reg_{line}$	– – – –	0.2 2.6 3.3 4.3 6.7	0.4 6.0 7.5 10 15	% mV
Dropout Voltage (Measured at $V_{out} - 100 \text{ mV}$ ) ( $I_{out} = 100 \text{ mA}$ ) ( $I_{out} = 500 \text{ mA}$ ) ( $I_{out} = 800 \text{ mA}$ )	$V_{in}-V_{out}$	– – –	0.95 1.01 1.07	1.10 1.15 1.20	V
Output Current Limit ( $V_{in}-V_{out} = 5.0 \text{ V}$ , $T_A = 25^\circ\text{C}$ , Note 6)	$I_{out}$	1000	1500	2200	mA
Minimum Required Load Current for Regulation, Adjustable Output Devices ( $V_{in} = 15 \text{ V}$ )	$I_{L(min)}$	–	0.8	5.0	mA
Quiescent Current 1.8 V ( $V_{in} = 11.8 \text{ V}$ ) 2.5 V ( $V_{in} = 10 \text{ V}$ ) 3.3 V ( $V_{in} = 15 \text{ V}$ ) 5.0 V ( $V_{in} = 15 \text{ V}$ )	$I_Q$	– – – –	4.2 5.2 6.0 6.0	10 10 10 10	mA
Thermal Regulation ( $T_A = 25^\circ\text{C}$ , 30 ms Pulse)		–	0.01	0.1	%/W
Ripple Rejection ( $V_{in}-V_{out} = 6.4 \text{ V}$ , $I_{out} = 500 \text{ mA}$ , 10 $V_{pp}$ 120 Hz Sinewave) Adjustable 1.8 V 2.5 V 3.3 V 5.0 V	RR	67 66 62 60 57	73 70 68 64 61	– – – – –	dB
Adjustment Pin Current ( $V_{in} = 11.25 \text{ V}$ , $I_{out} = 800 \text{ mA}$ )	$I_{adj}$	–	52	120	$\mu\text{A}$
Adjust Pin Current Change ( $V_{in}-V_{out} = 1.4 \text{ V to } 10 \text{ V}$ , $I_{out} = 10 \text{ mA to } 800 \text{ mA}$ )	$\Delta I_{adj}$	–	0.4	5.0	$\mu\text{A}$
Temperature Stability	$S_T$	–	0.5	–	%
Long Term Stability ( $T_A = 25^\circ\text{C}$ , 1000 Hrs End Point Measurement)	$S_t$	–	0.3	–	%
RMS Output Noise ( $f = 10 \text{ Hz to } 10 \text{ kHz}$ )	N	–	0.003	–	% $V_{out}$

Product parametric performance is indicated in the Electrical Characteristics for the listed test conditions, unless otherwise noted. Product performance may not be indicated by the Electrical Characteristics if operated under different conditions.

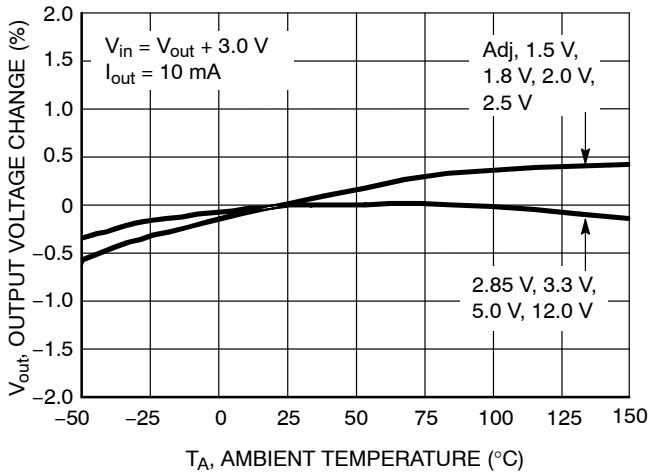
4. LM1117:  $T_{low} = 0^\circ\text{C}$ ,  $T_{high} = 125^\circ\text{C}$

LM1117I:  $T_{low} = -40^\circ\text{C}$ ,  $T_{high} = 125^\circ\text{C}$

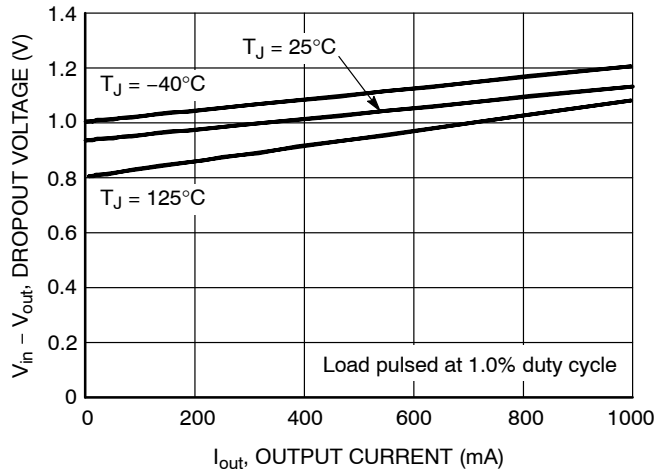
5. Low duty cycle pulse techniques are used during testing to maintain the junction temperature as close to ambient as possible.

6. The regulator output current must not exceed 1.0 A with  $V_{in}$  greater than 12 V.

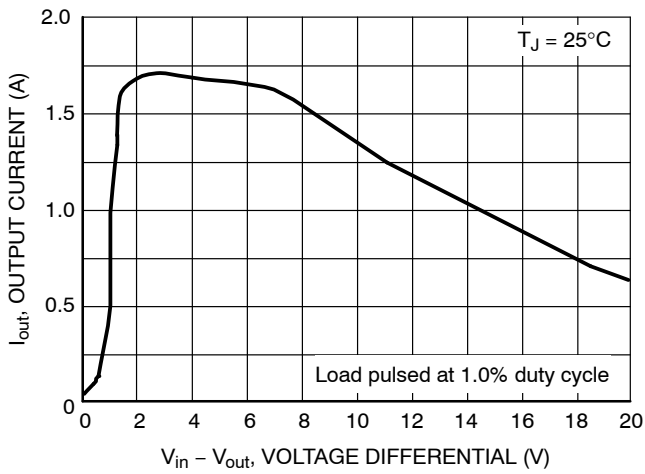
# LM1117, LM1117I



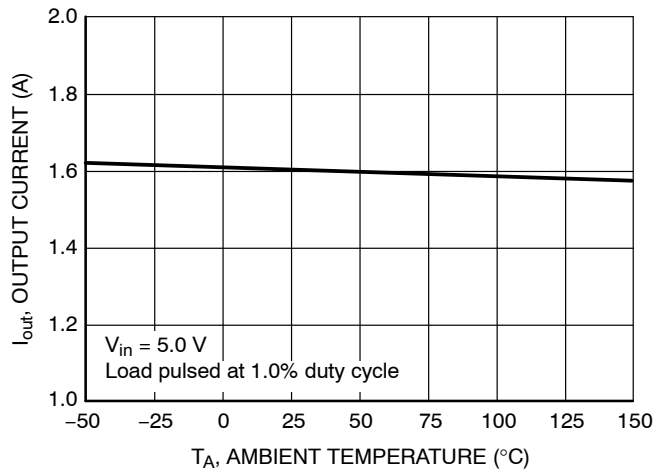
**Figure 4. Output Voltage Change vs. Temperature**



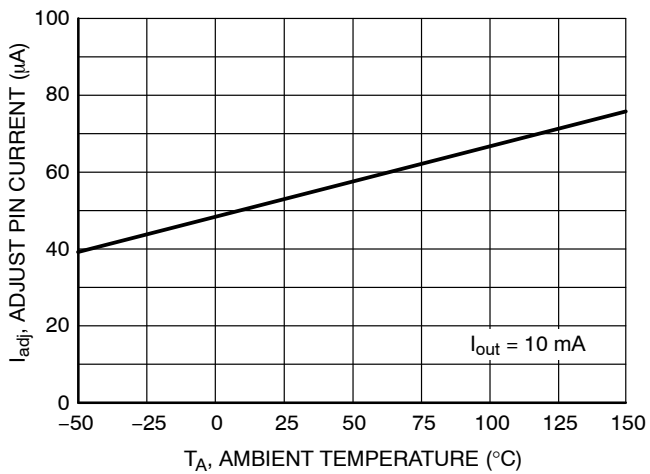
**Figure 5. Dropout Voltage vs. Output Current**



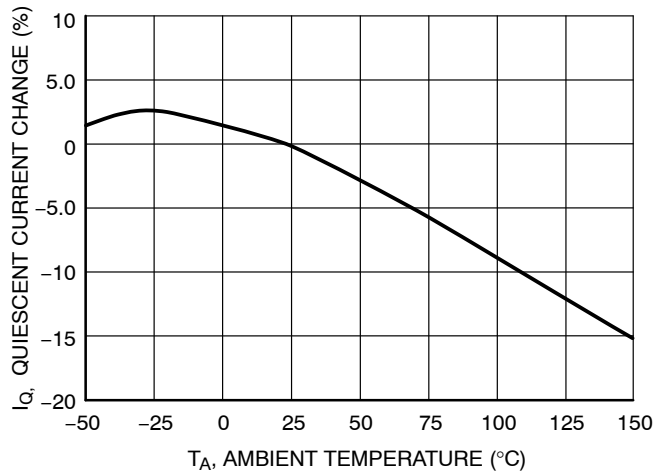
**Figure 6. Output Short Circuit Current vs. Differential Voltage**



**Figure 7. Output Short Circuit Current vs. Temperature**

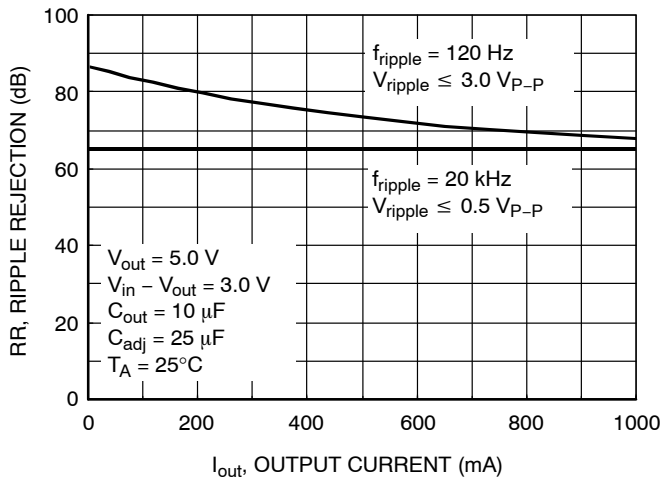


**Figure 8. Adjust Pin Current vs. Temperature**

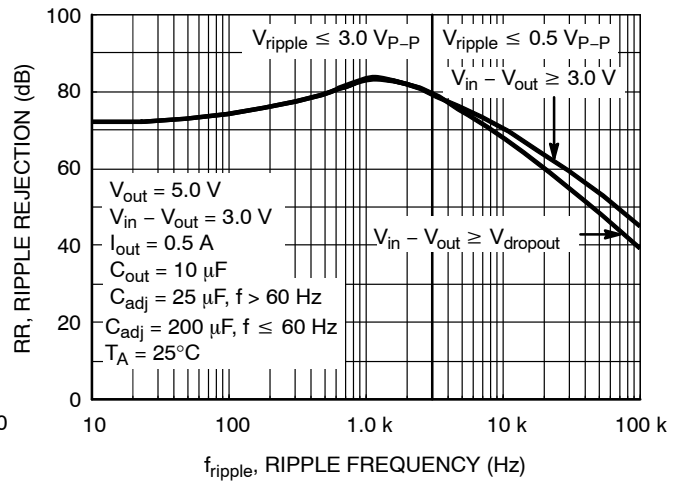


**Figure 9. Quiescent Current Change vs. Temperature**

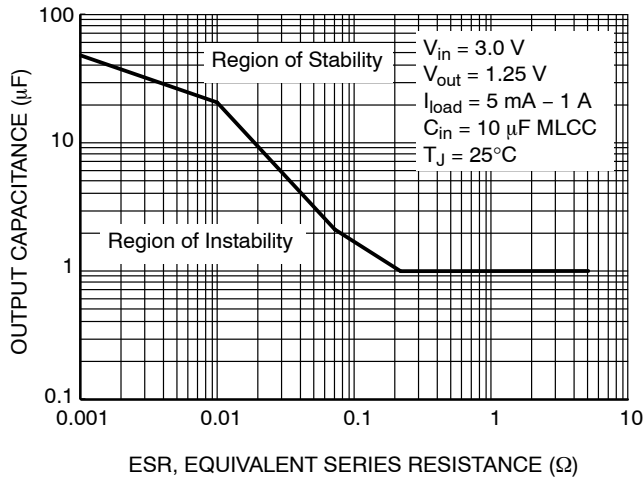
# LM1117, LM1117I



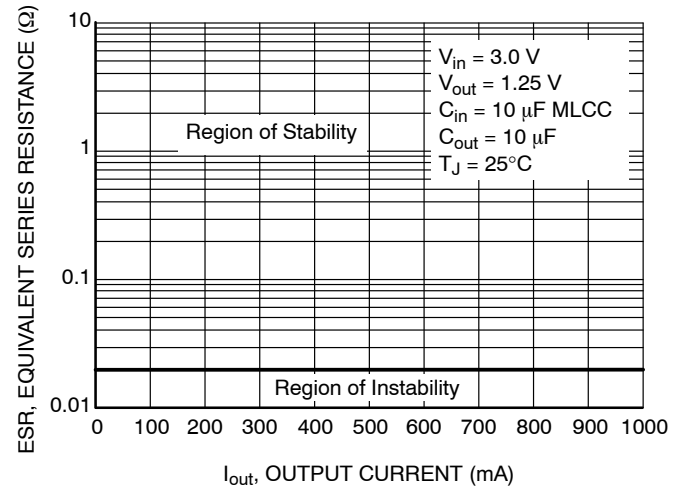
**Figure 10. LM1117XTA Ripple Rejection vs. Output Current**



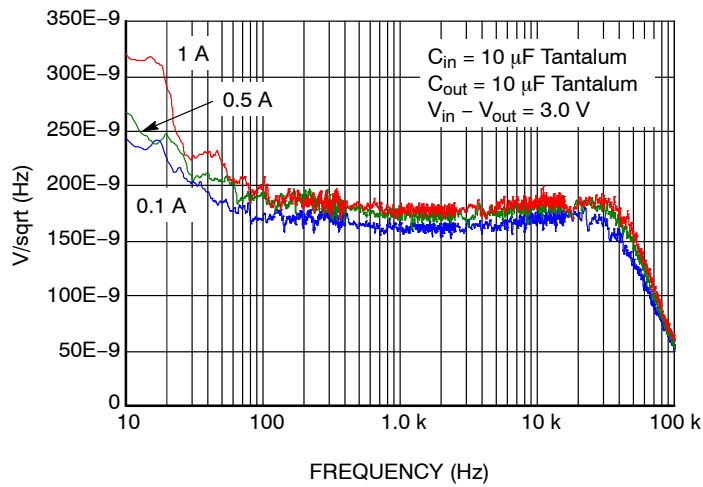
**Figure 11. LM1117XTA Ripple Rejection vs. Frequency**



**Figure 12. Output Capacitance vs. ESR**

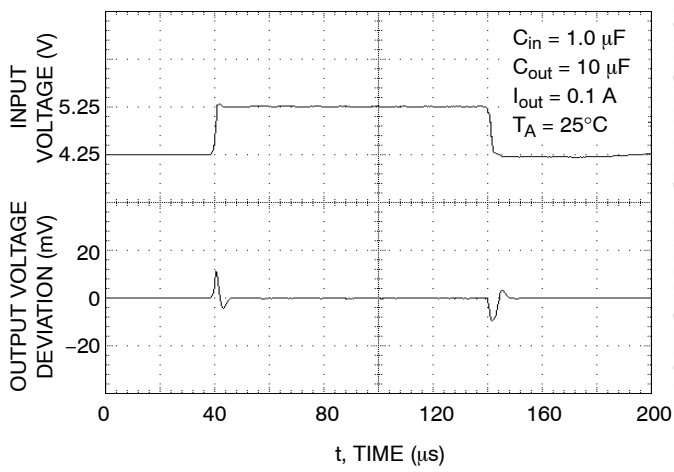


**Figure 13. Typical ESR vs. Output Current**

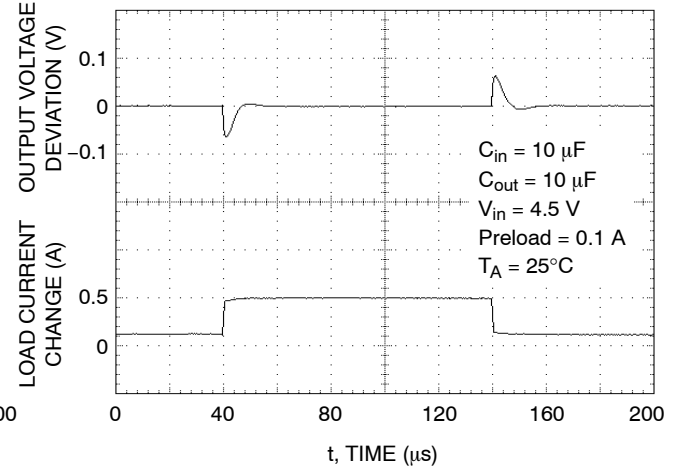


**Figure 14. Output Spectral Noise Density vs. Frequency,  $V_{out} = 1V5$**

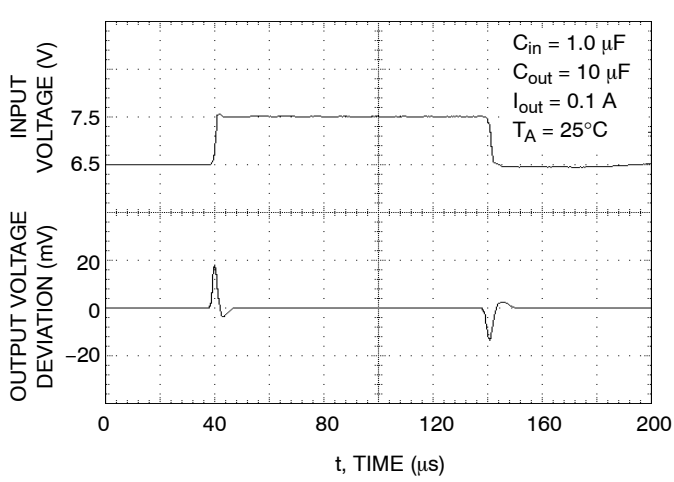
# LM1117, LM1117I



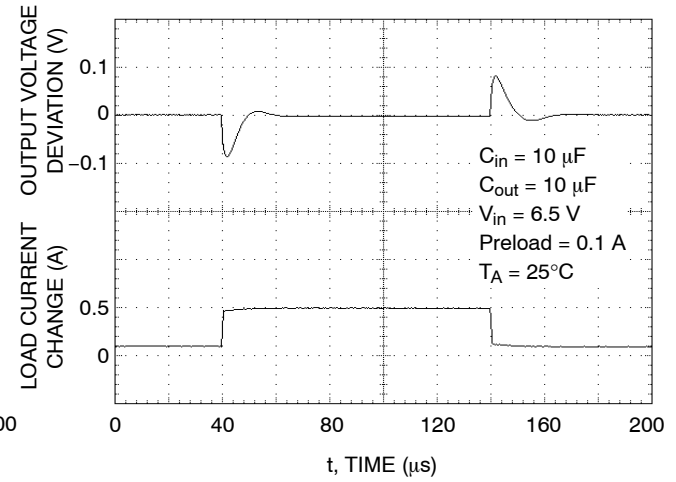
**Figure 15. LM1117XT285  
Line Transient Response**



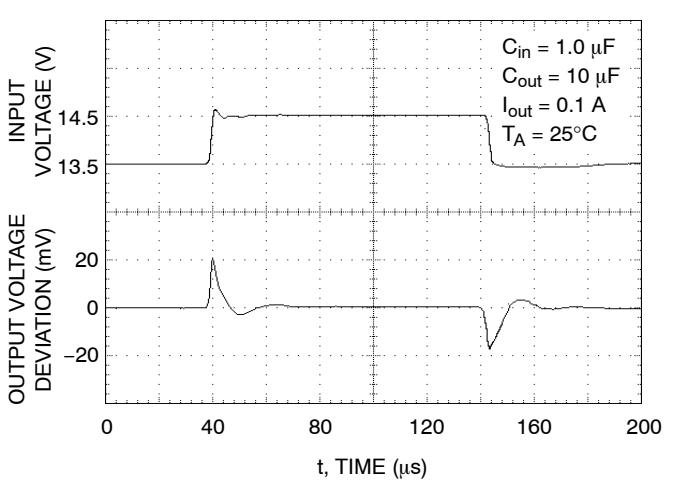
**Figure 16. LM1117XT285  
Load Transient Response**



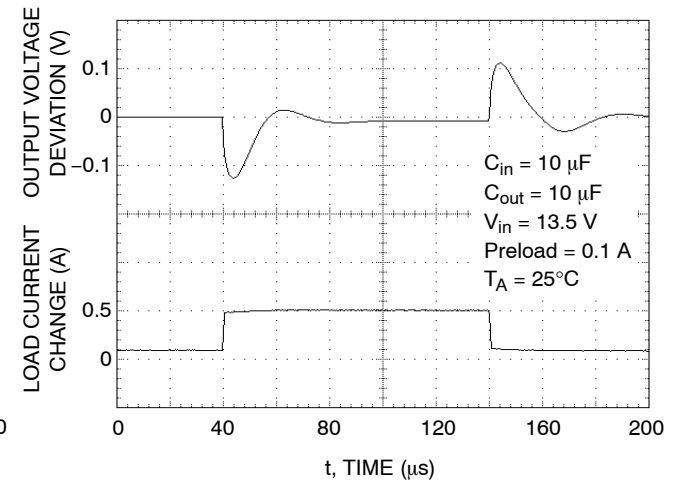
**Figure 17. LM1117XT50  
Line Transient Response**



**Figure 18. LM1117XT50  
Load Transient Response**

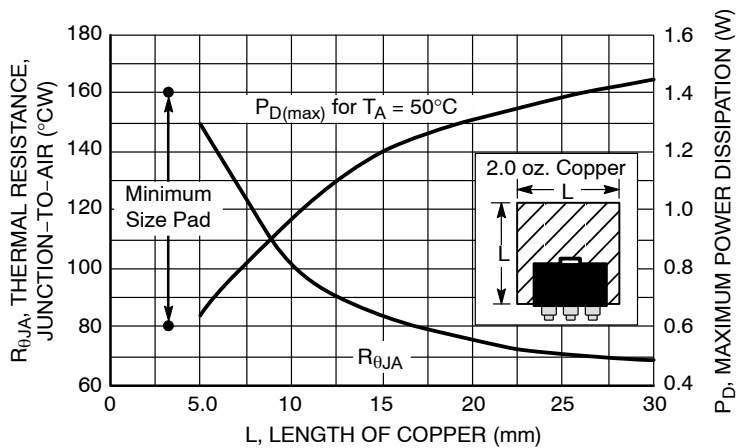


**Figure 19. LM1117XT12 Line  
Transient Response**

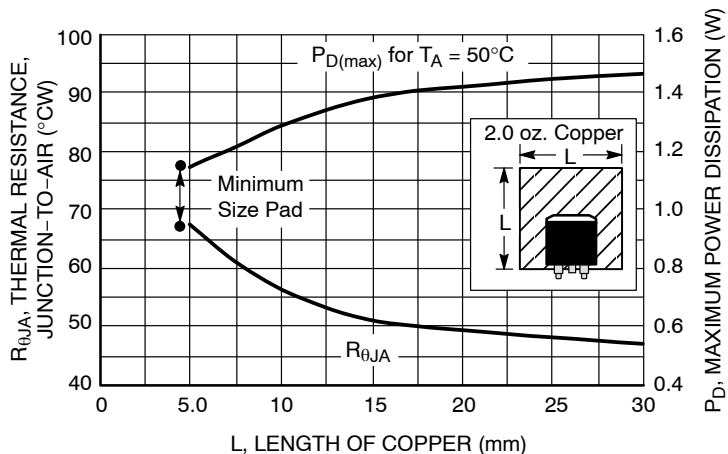


**Figure 20. LM1117XT12 Load  
Transient Response**

# LM1117, LM1117I



**Figure 21. SOT-223 Thermal Resistance and Maximum Power Dissipation vs. P.C.B. Copper Length**



**Figure 22. DPAK Thermal Resistance and Maximum Power Dissipation vs. P.C.B. Copper Length**

APPLICATIONS INFORMATION

Introduction

The LM1117 features a significant reduction in dropout voltage along with enhanced output voltage accuracy and temperature stability when compared to older industry standard three-terminal adjustable regulators. These devices contain output current limiting, safe operating area compensation and thermal shutdown protection making them designer friendly for powering numerous consumer and industrial products. The LM1117 series is pin compatible with the older LM317 and its derivative device types.

Output Voltage

The typical application circuits for the fixed and adjustable output regulators are shown in Figures 23 and 24. The adjustable devices are floating voltage regulators. They develop and maintain the nominal 1.25 V reference voltage between the output and adjust pins. The reference voltage is programmed to a constant current source by resistor R1, and this current flows through R2 to ground to set the output voltage. The programmed current level is usually selected to be greater than the specified 5.0 mA minimum that is required for regulation. Since the adjust pin current,  $I_{adj}$ , is significantly lower and constant with respect to the programmed load current, it generates a small output voltage error that can usually be ignored. For the fixed output devices R1 and R2 are included within the device and the ground current  $I_{gnd}$ , ranges from 3.0 mA to 5.0 mA depending upon the output voltage.

External Capacitors

Input bypass capacitor  $C_{in}$  may be required for regulator stability if the device is located more than a few inches from the power source. This capacitor will reduce the circuit's sensitivity when powered from a complex source impedance and significantly enhance the output transient response. The input bypass capacitor should be mounted with the shortest possible track length directly across the regulator's input and ground terminals. A 10  $\mu$ F ceramic or tantalum capacitor should be adequate for most applications.

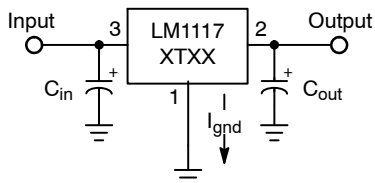
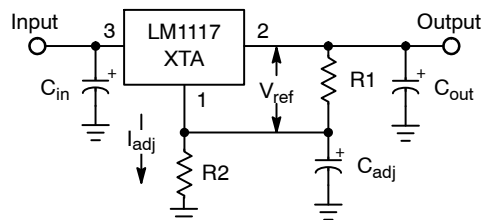


Figure 23. Fixed Output Regulator

Frequency compensation for the regulator is provided by capacitor  $C_{out}$  and its use is mandatory to ensure output stability. A minimum capacitance value of 4.7  $\mu$ F with an equivalent series resistance (ESR) that is within the limits of 33 m $\Omega$  (typ) to 2.2  $\Omega$  is required. See Figures 12 and 13. The capacitor type can be ceramic, tantalum, or aluminum electrolytic as long as it meets the minimum capacitance value and ESR limits over the circuit's entire operating temperature range. Higher values of output capacitance can be used to enhance loop stability and transient response with the additional benefit of reducing output noise.



$$V_{out} = V_{ref} \left( 1 + \frac{R_2}{R_1} \right) + I_{adj} R_2$$

Figure 24. Adjustable Output Regulator

The output ripple will increase linearly for fixed and adjustable devices as the ratio of output voltage to the reference voltage increases. For example, with a 12 V regulator, the output ripple will increase by 12 V/1.25 V or 9.6 and the ripple rejection will decrease by 20 log of this ratio or 19.6 dB. The loss of ripple rejection can be restored to the values shown with the addition of bypass capacitor  $C_{adj}$ , shown in Figure 24. The reactance of  $C_{adj}$  at the ripple frequency must be less than the resistance of R1. The value of R1 can be selected to provide the minimum required load current to maintain regulation and is usually in the range of 100  $\Omega$  to 200  $\Omega$ .

$$C_{adj} > \frac{1}{2 \pi f_{ripple} R_1}$$

The minimum required capacitance can be calculated from the above formula. When using the device in an application that is powered from the AC line via a transformer and a full wave bridge, the value for  $C_{adj}$  is:

$$f_{ripple} = 120 \text{ Hz}, R_1 = 120 \Omega, \text{ then } C_{adj} > 11.1 \mu\text{F}$$

The value for  $C_{adj}$  is significantly reduced in applications where the input ripple frequency is high. If used as a post regulator in a switching converter under the following conditions:

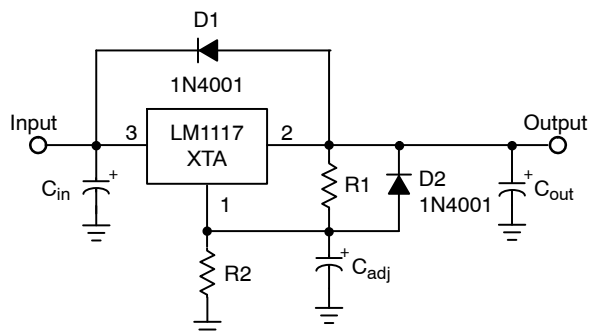
$$f_{ripple} = 50 \text{ kHz}, R_1 = 120 \Omega, \text{ then } C_{adj} > 0.027 \mu\text{F}$$

Figures 10 and 11 shows the level of ripple rejection that is obtainable with the adjust pin properly bypassed.



**Protection Diodes**

The LM1117 family has two internal low impedance diode paths that normally do not require protection when used in the typical regulator applications. The first path connects between  $V_{out}$  and  $V_{in}$ , and it can withstand a peak surge current of about 15 A. Normal cycling of  $V_{in}$  cannot generate a current surge of this magnitude. Only when  $V_{in}$  is shorted or crowbarred to ground and  $C_{out}$  is greater than 50  $\mu$ F, it becomes possible for device damage to occur. Under these conditions, diode D1 is required to protect the device. The second path connects between  $C_{adj}$  and  $V_{out}$ , and it can withstand a peak surge current of about 150 mA. Protection diode D2 is required if the output is shorted or crowbarred to ground and  $C_{adj}$  is greater than 1.0  $\mu$ F.



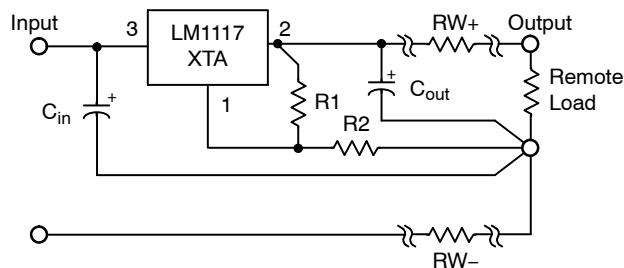
**Figure 25. Protection Diode Placement**

A combination of protection diodes D1 and D2 may be required in the event that  $V_{in}$  is shorted to ground and  $C_{adj}$  is greater than 50  $\mu$ F. The peak current capability stated for the internal diodes are for a time of 100  $\mu$ s with a junction temperature of 25°C. These values may vary and are to be used as a general guide.

**Load Regulation**

The LM1117 series is capable of providing excellent load regulation; but since these are three terminal devices, only partial remote load sensing is possible. There are two conditions that must be met to achieve the maximum available load regulation performance. The first is that the top side of programming resistor R1 should be connected as close to the regulator case as practicable. This will minimize the voltage drop caused by wiring resistance  $RW+$  from appearing in series with reference voltage that is across R1.

The second condition is that the ground end of R2 should be connected directly to the load. This allows true Kelvin sensing where the regulator compensates for the voltage drop caused by wiring resistance  $RW-$ .



**Figure 26. Load Sensing**

**Thermal Considerations**

This series contains an internal thermal limiting circuit that is designed to protect the regulator in the event that the maximum junction temperature is exceeded. When activated, typically at 175°C, the regulator output switches off and then back on as the die cools. As a result, if the device is continuously operated in an overheated condition, the output will appear to be oscillating. This feature provides protection from a catastrophic device failure due to accidental overheating. It is not intended to be used as a substitute for proper heatsinking. The maximum device power dissipation can be calculated by:

$$P_D = \frac{T_{J(max)} - T_A}{R_{\theta JA}}$$

The devices are available in surface mount SOT-223 and DPAK packages. Each package has an exposed metal tab that is specifically designed to reduce the junction to air thermal resistance,  $R_{\theta JA}$ , by utilizing the printed circuit board copper as a heat dissipater. Figures 21 and 22 show typical  $R_{\theta JA}$  values that can be obtained from a square pattern using economical single sided 2.0 ounce copper board material. The final product thermal limits should be tested and quantified in order to insure acceptable performance and reliability. The actual  $R_{\theta JA}$  can vary considerably from the graphs shown. This will be due to any changes made in the copper aspect ratio of the final layout, adjacent heat sources, and air flow.

# LM1117, LM1117I

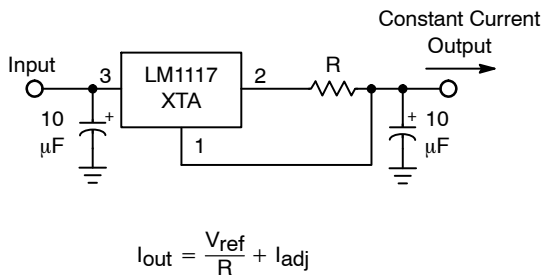


Figure 27. Constant Current Regulator

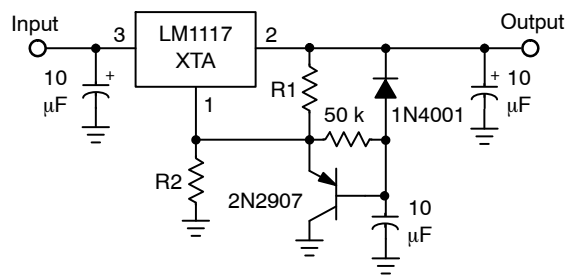


Figure 28. Slow Turn-On Regulator

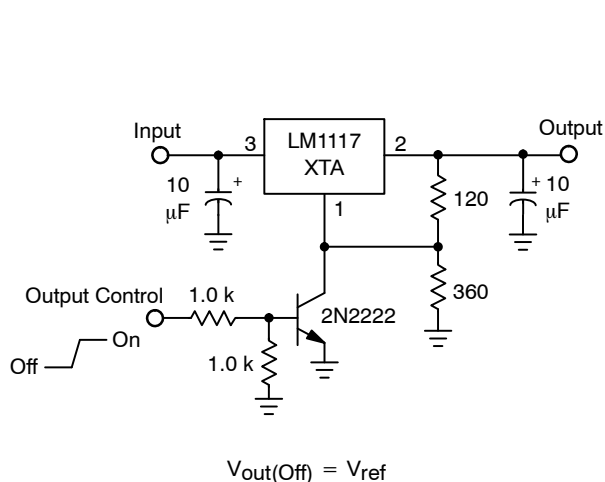
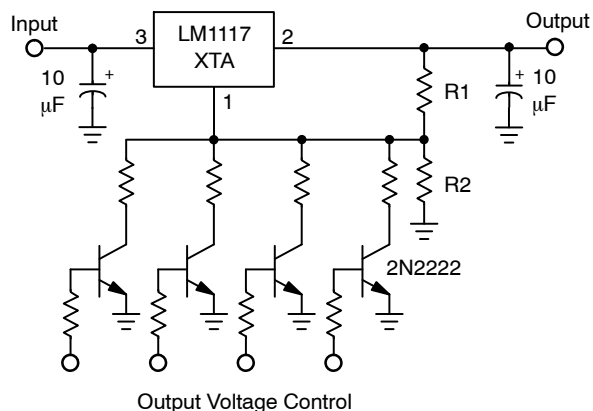
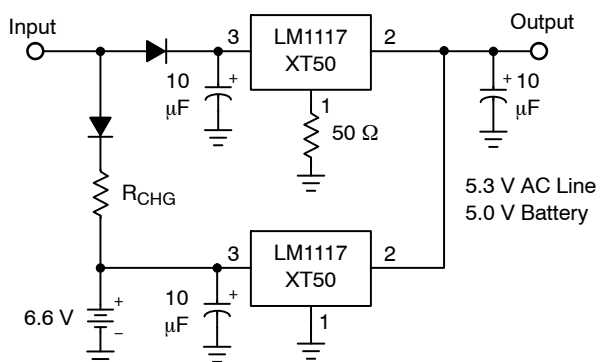


Figure 29. Regulator with Shutdown



Resistor R2 sets the maximum output voltage. Each transistor reduces the output voltage when turned on.

Figure 30. Digitally Controlled Regulator



The 50 Ω resistor that is in series with the ground pin of the upper regulator level shifts its output 300 mV higher than the lower regulator. This keeps the lower regulator off until the input source is removed.

Figure 31. Battery Backed-Up Power Supply

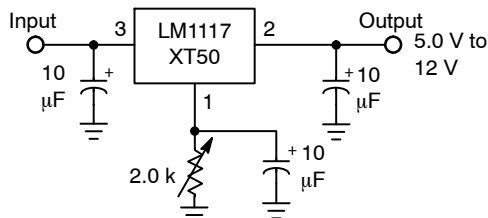


Figure 32. Adjusting Output of Fixed Voltage Regulators

# LM1117, LM1117I

## ORDERING INFORMATION – (LM1117)

Device	Nominal Output Voltage	Package	Shipping <sup>†</sup>
LM1117MPX-ADJNOPB	Adjustable	SOT-223 (Pb-Free)	4000 / Tape & Reel
LM1117MPX-18NOPB	1.8		
LM1117MPX-25NOPB	2.5		
LM1117MPX-33NOPB	3.3		
LM1117MPX-50NOPB	5.0		

<sup>†</sup>For information on tape and reel specifications, including part orientation and tape sizes, please refer to our Tape and Reel Packaging Specifications Brochure, BRD8011/D.

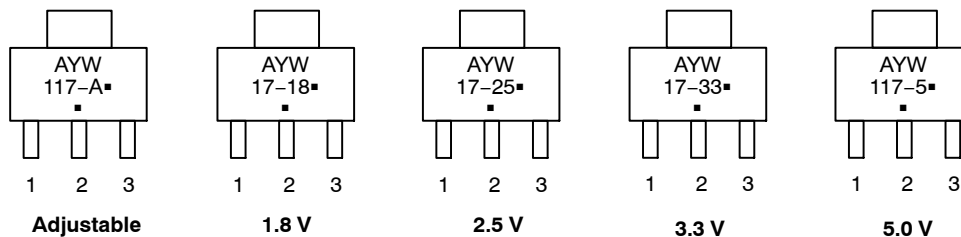
## ORDERING INFORMATION – (LM1117I)

Device	Nominal Output Voltage	Package	Shipping <sup>†</sup>
LM1117IMPX-ADJNOPB	Adjustable	SOT-223 (Pb-Free)	4000 / Tape & Reel

<sup>†</sup>For information on tape and reel specifications, including part orientation and tape sizes, please refer to our Tape and Reel Packaging Specifications Brochure, BRD8011/D.

## MARKING DIAGRAMS – LM1117

### SOT-223 CASE 318H

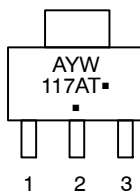


A = Assembly Location  
Y = Year  
W = Work Week  
▪ = Pb-Free Package

(Note: Microdot may be in either location)

## MARKING DIAGRAMS – LM1117I

### SOT-223 CASE 318H



Adjustable

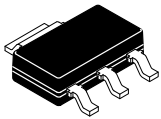
A = Assembly Location  
Y = Year  
W = Work Week  
▪ = Pb-Free Package

(Note: Microdot may be in either location)

# MECHANICAL CASE OUTLINE

## PACKAGE DIMENSIONS

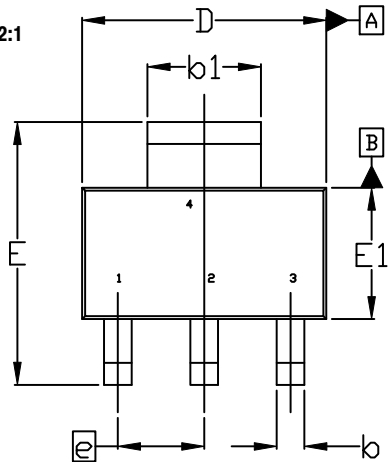
ON Semiconductor®



**SOT-223**  
CASE 318H  
ISSUE B

DATE 13 MAY 2020

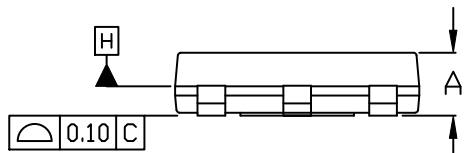
SCALE 2:1



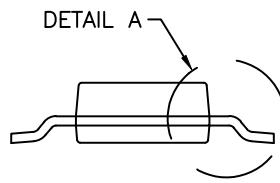
TOP VIEW

$\Phi 0.10 \text{ (M)}$  C A B

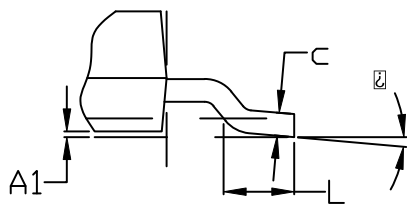
NOTE 7



SIDE VIEW



END VIEW

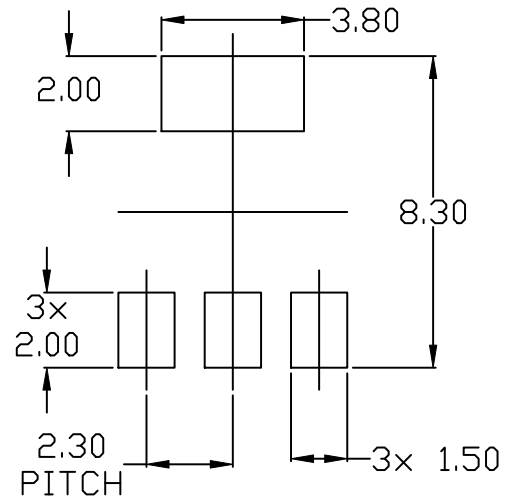


DETAIL A

**NOTES:**

1. DIMENSIONING AND TOLERANCING PER ASME Y14.5M, 2009.
2. CONTROLLING DIMENSION: MILLIMETERS
3. DIMENSIONS D & E1 ARE DETERMINED AT DATUM H. DIMENSIONS DO NOT INCLUDE MOLD FLASH, PROTRUSIONS OR GATE BURRS. SHALL NOT EXCEED 0.23mm PER SIDE.
4. LEAD DIMENSIONS b AND b1 DO NOT INCLUDE DAMBAR PROTRUSION. ALLOWABLE DAMBAR PROTRUSION IS 0.08mm PER SIDE.
5. DATUMS A AND B ARE DETERMINED AT DATUM H.
6. A1 IS DEFINED AS THE VERTICAL DISTANCE FROM THE SEATING PLANE TO THE LOWEST POINT OF THE PACKAGE BODY.
7. POSITIONAL TOLERANCE APPLIES TO DIMENSIONS b AND b1.

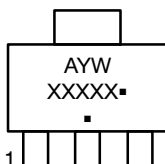
DIM	MILLIMETERS		
	MIN.	NOM.	MAX.
A	---	---	1.80
A1	0.02	0.06	0.11
b	0.60	0.74	0.88
b1	2.90	3.00	3.10
c	0.24	---	0.35
D	6.30	6.50	6.70
E	6.70	7.00	7.30
E1	3.30	3.50	3.70
e	2.30 BSC		
L	0.25	---	---
$\square$	0°	---	10°



RECOMMENDED MOUNTING FOOTPRINT

\* For additional information on our Pb-Free strategy and soldering details, please download the ON Semiconductor Soldering and Mounting Techniques Reference Manual, SOLDERM/D.

**GENERIC MARKING DIAGRAM\***



- A = Assembly Location
- Y = Year
- W = Work Week
- XXXXX = Specific Device Code
- = Pb-Free Package

(Note: Microdot may be in either location)

\*This information is generic. Please refer to device data sheet for actual part marking. Pb-Free indicator, "G" or microdot "▪", may or may not be present. Some products may not follow the Generic Marking.

<b>DOCUMENT NUMBER:</b>	<b>98ASH70634A</b>	Electronic versions are uncontrolled except when accessed directly from the Document Repository. Printed versions are uncontrolled except when stamped "CONTROLLED COPY" in red.
<b>DESCRIPTION:</b>	<b>SOT-223</b>	<b>PAGE 1 OF 1</b>

ON Semiconductor and are trademarks of Semiconductor Components Industries, LLC dba ON Semiconductor or its subsidiaries in the United States and/or other countries. ON Semiconductor reserves the right to make changes without further notice to any products herein. ON Semiconductor makes no warranty, representation or guarantee regarding the suitability of its products for any particular purpose, nor does ON Semiconductor assume any liability arising out of the application or use of any product or circuit, and specifically disclaims any and all liability, including without limitation special, consequential or incidental damages. ON Semiconductor does not convey any license under its patent rights nor the rights of others.

**onsemi**, **Onsemi**, and other names, marks, and brands are registered and/or common law trademarks of Semiconductor Components Industries, LLC dba "**onsemi**" or its affiliates and/or subsidiaries in the United States and/or other countries. **onsemi** owns the rights to a number of patents, trademarks, copyrights, trade secrets, and other intellectual property. A listing of **onsemi**'s product/patent coverage may be accessed at [www.onsemi.com/site/pdf/Patent-Marking.pdf](http://www.onsemi.com/site/pdf/Patent-Marking.pdf). **onsemi** reserves the right to make changes at any time to any products or information herein, without notice. The information herein is provided "as-is" and **onsemi** makes no warranty, representation or guarantee regarding the accuracy of the information, product features, availability, functionality, or suitability of its products for any particular purpose, nor does **onsemi** assume any liability arising out of the application or use of any product or circuit, and specifically disclaims any and all liability, including without limitation special, consequential or incidental damages. Buyer is responsible for its products and applications using **onsemi** products, including compliance with all laws, regulations and safety requirements or standards, regardless of any support or applications information provided by **onsemi**. "Typical" parameters which may be provided in **onsemi** data sheets and/or specifications can and do vary in different applications and actual performance may vary over time. All operating parameters, including "Typicals" must be validated for each customer application by customer's technical experts. **onsemi** does not convey any license under any of its intellectual property rights nor the rights of others. **onsemi** products are not designed, intended, or authorized for use as a critical component in life support systems or any FDA Class 3 medical devices or medical devices with a same or similar classification in a foreign jurisdiction or any devices intended for implantation in the human body. Should Buyer purchase or use **onsemi** products for any such unintended or unauthorized application, Buyer shall indemnify and hold **onsemi** and its officers, employees, subsidiaries, affiliates, and distributors harmless against all claims, costs, damages, and expenses, and reasonable attorney fees arising out of, directly or indirectly, any claim of personal injury or death associated with such unintended or unauthorized use, even if such claim alleges that **onsemi** was negligent regarding the design or manufacture of the part. **onsemi** is an Equal Opportunity/Affirmative Action Employer. This literature is subject to all applicable copyright laws and is not for resale in any manner.

## PUBLICATION ORDERING INFORMATION

### LITERATURE FULFILLMENT:

Email Requests to: [orderlit@onsemi.com](mailto:orderlit@onsemi.com)

**onsemi Website:** [www.onsemi.com](http://www.onsemi.com)

### TECHNICAL SUPPORT

**North American Technical Support:**

Voice Mail: 1 800-282-9855 Toll Free USA/Canada

Phone: 011 421 33 790 2910

**Europe, Middle East and Africa Technical Support:**

Phone: 00421 33 790 2910

For additional information, please contact your local Sales Representative