

MC14027B

Dual J-K Flip-Flop

The MC14027B dual J-K flip-flop has independent J, K, Clock (C), Set (S) and Reset (R) inputs for each flip-flop. These devices may be used in control, register, or toggle functions.

- Diode Protection on All Inputs
- Supply Voltage Range = 3.0 Vdc to 18 Vdc
- Logic Swing Independent of Fanout
- Logic Edge-Clocked Flip-Flop Design —
Logic state is retained indefinitely with clock level either high or low; information is transferred to the output only on the positive-going edge of the clock pulse
- Capable of Driving Two Low-power TTL Loads or One Low-power Schottky TTL Load Over the Rated Temperature Range
- Pin-for-Pin Replacement for CD4027B

MAXIMUM RATINGS (Voltages Referenced to V_{SS}) (Note 2.)

Symbol	Parameter	Value	Unit
V_{DD}	DC Supply Voltage Range	-0.5 to +18.0	V
V_{in}, V_{out}	Input or Output Voltage Range (DC or Transient)	-0.5 to $V_{DD} + 0.5$	V
I_{in}, I_{out}	Input or Output Current (DC or Transient) per Pin	± 10	mA
P_D	Power Dissipation, per Package (Note 3.)	500	mW
T_A	Ambient Temperature Range	-55 to +125	$^{\circ}C$
T_{stg}	Storage Temperature Range	-65 to +150	$^{\circ}C$
T_L	Lead Temperature (8-Second Soldering)	260	$^{\circ}C$

2. Maximum Ratings are those values beyond which damage to the device may occur.

3. Temperature Derating:
Plastic "P and D/DW" Packages: - 7.0 mW/ $^{\circ}C$ From 65 $^{\circ}C$ To 125 $^{\circ}C$

This device contains protection circuitry to guard against damage due to high static voltages or electric fields. However, precautions must be taken to avoid applications of any voltage higher than maximum rated voltages to this high-impedance circuit. For proper operation, V_{in} and V_{out} should be constrained to the range $V_{SS} \leq (V_{in} \text{ or } V_{out}) \leq V_{DD}$.

Unused inputs must always be tied to an appropriate logic voltage level (e.g., either V_{SS} or V_{DD}). Unused outputs must be left open.



ON Semiconductor

<http://onsemi.com>

MARKING DIAGRAMS

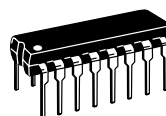

PDIP-16
P SUFFIX
CASE 648

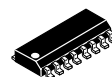
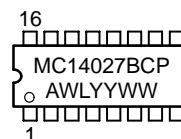

SOIC-16
D SUFFIX
CASE 751B

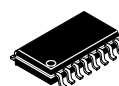
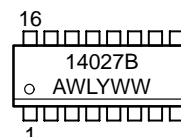

SOEIAJ-16
F SUFFIX
CASE 966

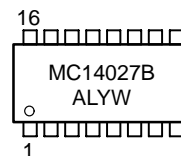

A = Assembly Location
WL, L = Wafer Lot
YY, Y = Year
WW, W = Work Week

ORDERING INFORMATION

Device	Package	Shipping
MC14027BCP	PDIP-16	2000/Box
MC14027BD	SOIC-16	2400/Box
MC14027BDR2	SOIC-16	2500/Tape & Reel
MC14027BF	SOEIAJ-16	See Note 1.
MC14027BFEL	SOEIAJ-16	See Note 1.

1. For ordering information on the EIAJ version of the SOIC packages, please contact your local ON Semiconductor representative.

MC14027B

TRUTH TABLE

Inputs					Outputs*		
C†	J	K	S	R	Q _n ‡	Q _{n+1}	Q̄ _{n+1}
↗	1	X	0	0	0	1	0
↗	X	0	0	0	1	1	0
↗	0	X	0	0	0	0	1
↗	X	1	0	0	1	0	1
↗	1	1	0	0	Q ₀	Q̄ ₀	Q ₀
↘	X	X	0	0	X	Q _n	Q̄ _n
X	X	X	1	0	X	1	0
X	X	X	0	1	X	0	1
X	X	X	1	1	X	1	1

X = Don't Care
† = Level Change

‡ = Present State
* = Next State

No
Change

PIN ASSIGNMENT

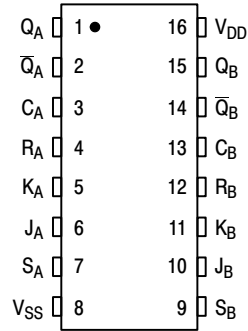

BLOCK DIAGRAM

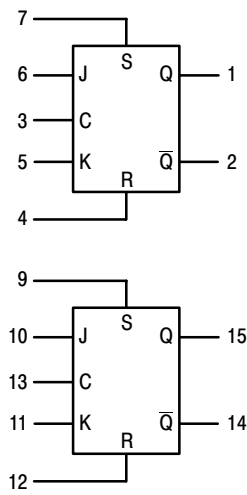

V_{DD} = PIN 16
V_{SS} = PIN 8

MC14027B

ELECTRICAL CHARACTERISTICS (Voltages Referenced to V_{SS})

Characteristic	Symbol	V_{DD} Vdc	- 55°C		25°C			125°C		Unit
			Min	Max	Min	Typ (4.)	Max	Min	Max	
Output Voltage $V_{in} = V_{DD}$ or 0 $V_{in} = 0$ or V_{DD}	"0" Level V_{OL}	5.0	—	0.05	—	0	0.05	—	0.05	Vdc
		10	—	0.05	—	0	0.05	—	0.05	
		15	—	0.05	—	0	0.05	—	0.05	
	"1" Level V_{OH}	5.0	4.95	—	4.95	5.0	—	4.95	—	Vdc
		10	9.95	—	9.95	10	—	9.95	—	
		15	14.95	—	14.95	15	—	14.95	—	
Input Voltage "0" Level ($V_O = 4.5$ or 0.5 Vdc) ($V_O = 9.0$ or 1.0 Vdc) ($V_O = 13.5$ or 1.5 Vdc) "1" Level ($V_O = 0.5$ or 4.5 Vdc) ($V_O = 1.0$ or 9.0 Vdc) ($V_O = 1.5$ or 13.5 Vdc)	V_{IL}	5.0	—	1.5	—	2.25	1.5	—	1.5	Vdc
		10	—	3.0	—	4.50	3.0	—	3.0	
		15	—	4.0	—	6.75	4.0	—	4.0	
	V_{IH}	5.0	3.5	—	3.5	2.75	—	3.5	—	Vdc
		10	7.0	—	7.0	5.50	—	7.0	—	
		15	11	—	11	8.25	—	11	—	
Output Drive Current Source ($V_{OH} = 2.5$ Vdc) ($V_{OH} = 4.6$ Vdc) ($V_{OH} = 9.5$ Vdc) ($V_{OH} = 13.5$ Vdc) Sink ($V_{OL} = 0.4$ Vdc) ($V_{OL} = 0.5$ Vdc) ($V_{OL} = 1.5$ Vdc)	I_{OH}	5.0	-3.0	—	-2.4	-4.2	—	-1.7	—	mAdc
		5.0	-0.64	—	-0.51	-0.88	—	-0.36	—	
		10	-1.6	—	-1.3	-2.25	—	-0.9	—	
		15	-4.2	—	-3.4	-8.8	—	-2.4	—	
	I_{OL}	5.0	0.64	—	0.51	0.88	—	0.36	—	mAdc
		10	1.6	—	1.3	2.25	—	0.9	—	
15		4.2	—	3.4	8.8	—	2.4	—		
Input Current	I_{in}	15	—	± 0.1	—	± 0.00001	± 0.1	—	± 1.0	μ Adc
Input Capacitance ($V_{in} = 0$)	C_{in}	—	—	—	—	5.0	7.5	—	—	pF
Quiescent Current (Per Package)	I_{DD}	5.0	—	1.0	—	0.002	1.0	—	30	μ Adc
		10	—	2.0	—	0.004	2.0	—	60	
		15	—	4.0	—	0.006	4.0	—	120	
Total Supply Current (5.) (6.) (Dynamic plus Quiescent, Per Package) ($C_L = 50$ pF on all outputs, all buffers switching)	I_T	5.0	$I_T = (0.8 \mu\text{A/kHz}) f + I_{DD}$							μ Adc
		10	$I_T = (1.6 \mu\text{A/kHz}) f + I_{DD}$							
		15	$I_T = (2.4 \mu\text{A/kHz}) f + I_{DD}$							

4. Data labelled "Typ" is not to be used for design purposes but is intended as an indication of the IC's potential performance.

5. The formulas given are for the typical characteristics only at 25°C.

6. To calculate total supply current at loads other than 50 pF:

$$I_T(C_L) = I_T(50 \text{ pF}) + (C_L - 50) Vfk$$

where: I_T is in μA (per package), C_L in pF, $V = (V_{DD} - V_{SS})$ in volts, f in kHz is input frequency, and $k = 0.002$.

MC14027B

SWITCHING CHARACTERISTICS (7.) ($C_L = 50 \text{ pF}$, $T_A = 25^\circ\text{C}$)

Characteristic	Symbol	V_{DD}	Min	Typ (8.)	Max	Unit
Output Rise and Fall Time $t_{TLH}, t_{THL} = (1.5 \text{ ns/pF}) C_L + 25 \text{ ns}$ $t_{TLH}, t_{THL} = (0.75 \text{ ns/pF}) C_L + 12.5 \text{ ns}$ $t_{TLH}, t_{THL} = (0.55 \text{ ns/pF}) C_L + 12.5 \text{ ns}$	$t_{TLH},$ t_{THL}	5.0 10 15	— — —	100 50 40	200 100 80	ns
Propagation Delay Times** Clock to Q, Q $t_{PLH}, t_{PHL} = (1.7 \text{ ns/pF}) C_L + 90 \text{ ns}$ $t_{PLH}, t_{PHL} = (0.66 \text{ ns/pF}) C_L + 42 \text{ ns}$ $t_{PLH}, t_{PHL} = (0.5 \text{ ns/pF}) C_L + 25 \text{ ns}$ Set to Q, Q $t_{PLH}, t_{PHL} = (1.7 \text{ ns/pF}) C_L + 90 \text{ ns}$ $t_{PLH}, t_{PHL} = (0.66 \text{ ns/pF}) C_L + 42 \text{ ns}$ $t_{PLH}, t_{PHL} = (0.5 \text{ ns/pF}) C_L + 25 \text{ ns}$ Reset to Q, Q $t_{PLH}, t_{PHL} = (1.7 \text{ ns/pF}) C_L + 265 \text{ ns}$ $t_{PLH}, t_{PHL} = (0.66 \text{ ns/pF}) C_L + 67 \text{ ns}$ $t_{PLH}, t_{PHL} = (0.5 \text{ ns/pF}) C_L + 50 \text{ ns}$	$t_{PLH},$ t_{PHL}	5.0 10 15 5.0 10 15 5.0 10 15	— — — — — — — — —	175 75 50 175 75 50 350 100 75	350 150 100 350 150 100 450 200 150	ns
Setup Times	t_{su}	5.0 10 15	140 50 35	70 25 17	— — —	ns
Hold Times	t_h	5.0 10 15	140 50 35	70 25 17	— — —	ns
Clock Pulse Width	t_{WH}, t_{WL}	5.0 10 15	330 110 75	165 55 38	— — —	ns
Clock Pulse Frequency	f_{cl}	5.0 10 15	— — —	3.0 9.0 13	1.5 4.5 6.5	MHz
Clock Pulse Rise and Fall Time	t_{TLH}, t_{THL}	5.0 10 15	— — —	— — —	15 5.0 4.0	μs
Removal Times Set Reset	t_{rem}	5 10 15 5 10 15	90 45 35 50 25 20	10 5 3 -30 -15 -10	— — — — — —	ns
Set and Reset Pulse Width	t_{WH}	5.0 10 15	250 100 70	125 50 35	— — —	ns

7. The formulas given are for the typical characteristics only at 25°C.

8. Data labelled "Typ" is not to be used for design purposes but is intended as an indication of the IC's potential performance.

MC14027B

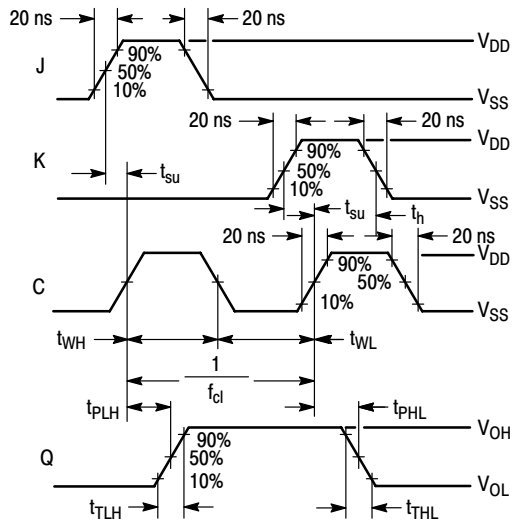

Inputs R and S low.
 For the measurement of t_{WH} , $1/f_{cl}$, and P_D
 the Inputs J and K are kept high.

**Figure 1. Dynamic Signal Waveforms
 (J, K, Clock, and Output)**

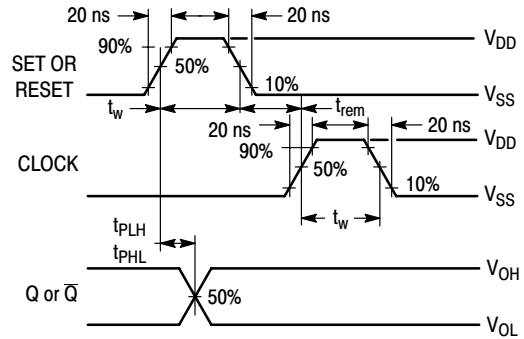

**Figure 2. Dynamic Signal Waveforms
 (Set, Reset, Clock, and Output)**

LOGIC DIAGRAM (1/2 of Device Shown)

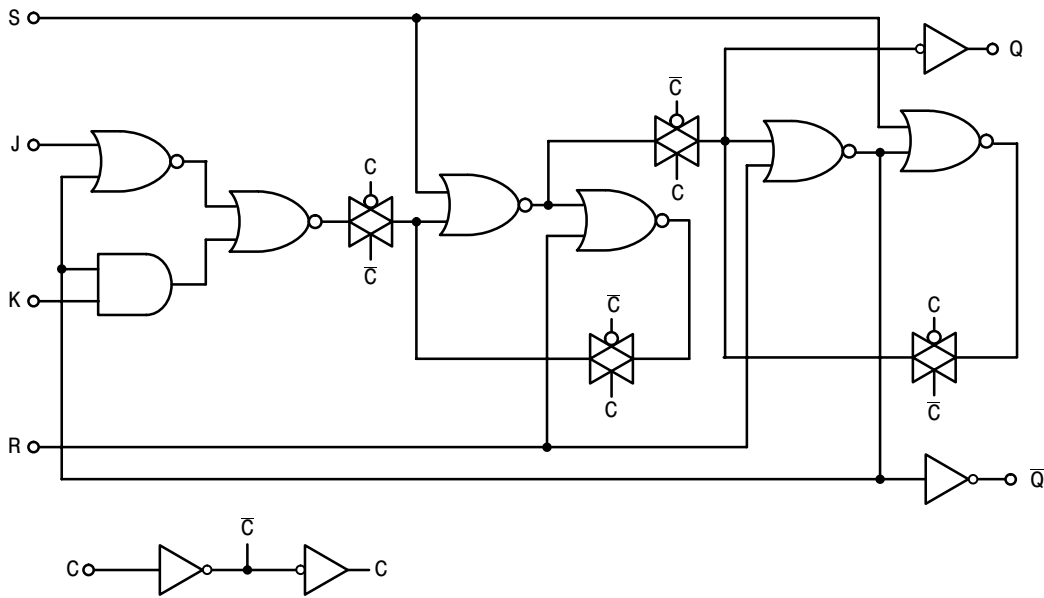

MC14027B

PACKAGE DIMENSIONS

PDIP-16 P SUFFIX PLASTIC DIP PACKAGE CASE 648-08 ISSUE R

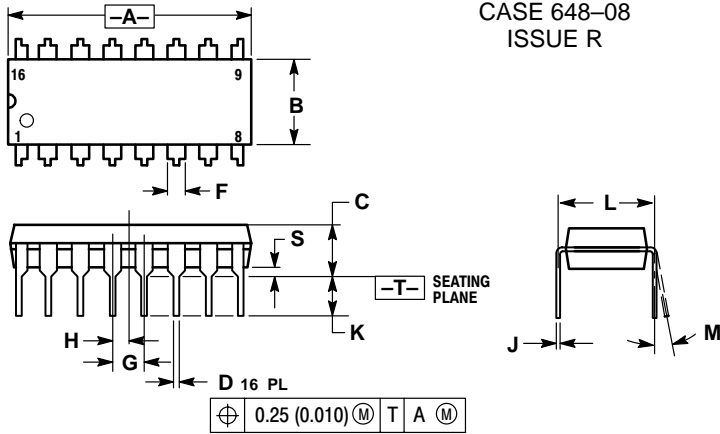

NOTES:

1. DIMENSIONING AND TOLERANCING PER ANSI Y14.5M, 1982.
2. CONTROLLING DIMENSION: INCH.
3. DIMENSION L TO CENTER OF LEADS WHEN FORMED PARALLEL.
4. DIMENSION B DOES NOT INCLUDE MOLD FLASH.
5. ROUNDED CORNERS OPTIONAL.

DIM	INCHES		MILLIMETERS	
	MIN	MAX	MIN	MAX
A	0.740	0.770	18.80	19.55
B	0.250	0.270	6.35	6.85
C	0.145	0.175	3.69	4.44
D	0.015	0.021	0.39	0.53
F	0.040	0.70	1.02	1.77
G	0.100 BSC		2.54 BSC	
H	0.050 BSC		1.27 BSC	
J	0.008	0.015	0.21	0.38
K	0.110	0.130	2.80	3.30
L	0.295	0.305	7.50	7.74
M	0°	10°	0°	10°
S	0.020	0.040	0.51	1.01

SOIC-16 D SUFFIX PLASTIC SOIC PACKAGE CASE 751B-05 ISSUE J

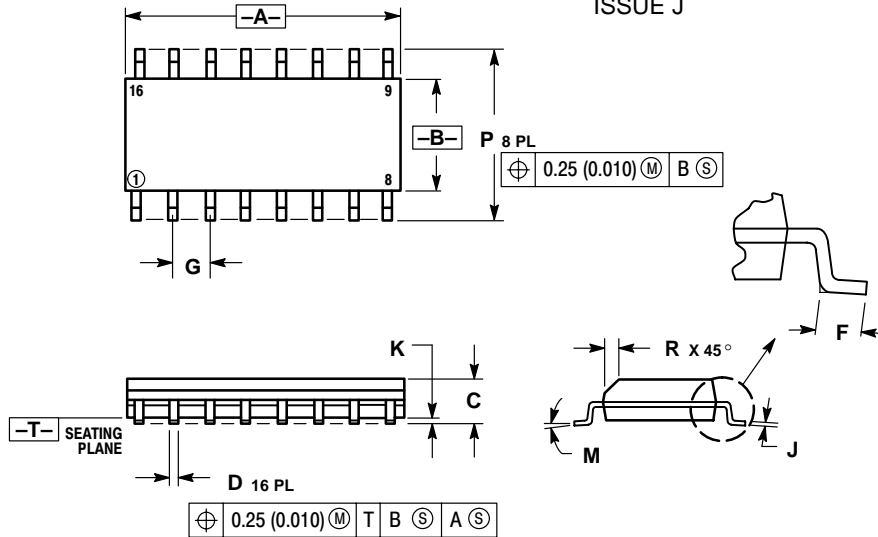

NOTES:

1. DIMENSIONING AND TOLERANCING PER ANSI Y14.5M, 1982.
2. CONTROLLING DIMENSION: MILLIMETER.
3. DIMENSIONS A AND B DO NOT INCLUDE MOLD PROTRUSION.
4. MAXIMUM MOLD PROTRUSION 0.15 (0.006) PER SIDE.
5. DIMENSION D DOES NOT INCLUDE DAMBAR PROTRUSION. ALLOWABLE DAMBAR PROTRUSION SHALL BE 0.127 (0.005) TOTAL IN EXCESS OF THE D DIMENSION AT MAXIMUM MATERIAL CONDITION.

DIM	MILLIMETERS		INCHES	
	MIN	MAX	MIN	MAX
A	9.80	10.00	0.386	0.393
B	3.80	4.00	0.150	0.157
C	1.35	1.75	0.054	0.068
D	0.35	0.49	0.014	0.019
F	0.40	1.25	0.016	0.049
G	1.27 BSC		0.050 BSC	
J	0.19	0.25	0.008	0.009
K	0.10	0.25	0.004	0.009
M	0°	7°	0°	7°
P	5.80	6.20	0.229	0.244
R	0.25	0.50	0.010	0.019

MC14027B

PACKAGE DIMENSIONS

SOEIAJ-16
F SUFFIX
PLASTIC EIAJ SOIC PACKAGE
CASE 966-01
ISSUE O

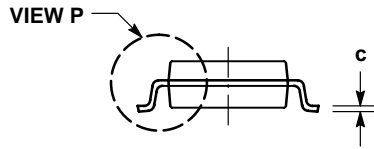
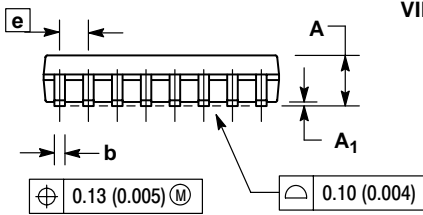
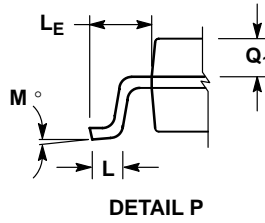
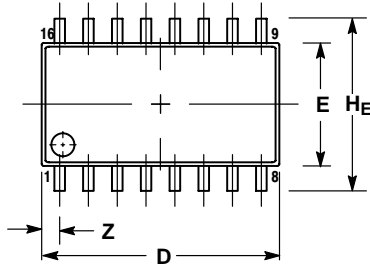

NOTES:

1. DIMENSIONING AND TOLERANCING PER ANSI Y14.5M, 1982.
2. CONTROLLING DIMENSION: MILLIMETER.
3. DIMENSIONS D AND E DO NOT INCLUDE MOLD FLASH OR PROTRUSIONS AND ARE MEASURED AT THE PARTING LINE. MOLD FLASH OR PROTRUSIONS SHALL NOT EXCEED 0.15 (0.006) PER SIDE.
4. TERMINAL NUMBERS ARE SHOWN FOR REFERENCE ONLY.
5. THE LEAD WIDTH DIMENSION (b) DOES NOT INCLUDE DAMBAR PROTRUSION. ALLOWABLE DAMBAR PROTRUSION SHALL BE 0.08 (0.003) TOTAL IN EXCESS OF THE LEAD WIDTH DIMENSION AT MAXIMUM MATERIAL CONDITION. DAMBAR CANNOT BE LOCATED ON THE LOWER RADIUS OR THE FOOT. MINIMUM SPACE BETWEEN PROTRUSIONS AND ADJACENT LEAD TO BE 0.46 (0.018).

DIM	MILLIMETERS		INCHES	
	MIN	MAX	MIN	MAX
A	---	2.05	---	0.081
A ₁	0.05	0.20	0.002	0.008
b	0.35	0.50	0.014	0.020
c	0.18	0.27	0.007	0.011
D	9.90	10.50	0.390	0.413
E	5.10	5.45	0.201	0.215
e	1.27 BSC		0.050 BSC	
HE	7.40	8.20	0.291	0.323
L	0.50	0.85	0.020	0.033
LE	1.10	1.50	0.043	0.059
M	0°	10°	0°	10°
Q ₁	0.70	0.90	0.028	0.035
Z	---	0.78	---	0.031

ON Semiconductor and  are trademarks of Semiconductor Components Industries, LLC (SCILLC). SCILLC reserves the right to make changes without further notice to any products herein. SCILLC makes no warranty, representation or guarantee regarding the suitability of its products for any particular purpose, nor does SCILLC assume any liability arising out of the application or use of any product or circuit, and specifically disclaims any and all liability, including without limitation special, consequential or incidental damages. "Typical" parameters which may be provided in SCILLC data sheets and/or specifications can and do vary in different applications and actual performance may vary over time. All operating parameters, including "Typicals" must be validated for each customer application by customer's technical experts. SCILLC does not convey any license under its patent rights nor the rights of others. SCILLC products are not designed, intended, or authorized for use as components in systems intended for surgical implant into the body, or other applications intended to support or sustain life, or for any other application in which the failure of the SCILLC product could create a situation where personal injury or death may occur. Should Buyer purchase or use SCILLC products for any such unintended or unauthorized application, Buyer shall indemnify and hold SCILLC and its officers, employees, subsidiaries, affiliates, and distributors harmless against all claims, costs, damages, and expenses, and reasonable attorney fees arising out of, directly or indirectly, any claim of personal injury or death associated with such unintended or unauthorized use, even if such claim alleges that SCILLC was negligent regarding the design or manufacture of the part. SCILLC is an Equal Opportunity/Affirmative Action Employer.

PUBLICATION ORDERING INFORMATION

NORTH AMERICA Literature Fulfillment:

Literature Distribution Center for ON Semiconductor
P.O. Box 5163, Denver, Colorado 80217 USA
Phone: 303-675-2175 or 800-344-3860 Toll Free USA/Canada
Fax: 303-675-2176 or 800-344-3867 Toll Free USA/Canada
Email: ONlit@hibbertco.com
Fax Response Line: 303-675-2167 or 800-344-3810 Toll Free USA/Canada

N. American Technical Support: 800-282-9855 Toll Free USA/Canada

EUROPE: LDC for ON Semiconductor – European Support

German Phone: (+1) 303-308-7140 (Mon-Fri 2:30pm to 7:00pm CET)
Email: ONlit-german@hibbertco.com
French Phone: (+1) 303-308-7141 (Mon-Fri 2:00pm to 7:00pm CET)
Email: ONlit-french@hibbertco.com
English Phone: (+1) 303-308-7142 (Mon-Fri 12:00pm to 5:00pm GMT)
Email: ONlit@hibbertco.com

EUROPEAN TOLL-FREE ACCESS*: 00-800-4422-3781

*Available from Germany, France, Italy, UK

CENTRAL/SOUTH AMERICA:

Spanish Phone: 303-308-7143 (Mon-Fri 8:00am to 5:00pm MST)
Email: ONlit-spanish@hibbertco.com

ASIA/PACIFIC: LDC for ON Semiconductor – Asia Support

Phone: 303-675-2121 (Tue-Fri 9:00am to 1:00pm, Hong Kong Time)
Toll Free from Hong Kong & Singapore:
001-800-4422-3781
Email: ONlit-asia@hibbertco.com

JAPAN: ON Semiconductor, Japan Customer Focus Center
4-32-1 Nishi-Gotanda, Shinagawa-ku, Tokyo, Japan 141-0031

Phone: 81-3-5740-2745
Email: r14525@onsemi.com

ON Semiconductor Website: <http://onsemi.com>

For additional information, please contact your local Sales Representative.