

Series PVA10

Microelectronic Power IC
 BOSFET® Photovoltaic Relay
 Single-Pole, 70mA, 0-100V AC/DC

General Description

The Photovoltaic AC Relay (PVA) is a single-pole, normally open solid state replacement for electro-mechanical relays used for general purpose switching of analog signals. It utilizes as an output switch a unique bidirectional (AC or DC) MOSFET power IC termed a BOSFET. The BOSFET is controlled by a photovoltaic generator of novel construction, which is energized by radiation from a dielectrically isolated light emitting diode (LED).

The PVA overcomes the limitations of both conventional and reed electromechanical relays by offering the solid state advantages of long life, high operating speed, low pick-up power, bounce-free operation, low thermal voltages and miniaturization. These advantages allow product improvement and design innovations in many applications such as process control, multiplexing, telecommunications, automatic test equipment and data acquisition.

The PVA can switch analog signals from thermocouple level to 100 volts peak AC or DC polarity. Signal frequencies into the RF range are easily controlled and switching rates up to 18kHz are achievable. The extremely small thermally generated offset voltages allow increased measurement accuracies.

Unique silicon technology developed by International Rectifier forms the heart of the PVA. The monolithic BOSFET contains a bidirectional N-channel power MOSFET output structure. In addition, this power IC chip has input circuitry for fast turn-off and gate protection functions. This section of the BOSFET chip utilizes both bipolar and MOS technology to form NPN transistors, P-channel MOSFETs, resistors, diodes and capacitors.

The photovoltaic generator similarly utilizes a unique International Rectifier alloyed multijunction structure. The excellent current conversion efficiency of this technique results in the very fast response of the PVA microelectronic power IC relay.

This advanced semiconductor technology has created a radically new control device. Designers can now develop switching systems to new standards of electrical performance and mechanical compactness.

Features

- BOSFET Power IC ■
- 10¹⁰ Operations ■
- 25µsec Operating Time ■
- 0.2µVolt Thermal Offset ■
- 3 milliwatts Pick-Up Power ■
- 1000V/µsec dv/dt ■
- Bounce-Free ■
- 8-pin DIP Package ■
- 40°C to 85°C ■
- UL recognized ■

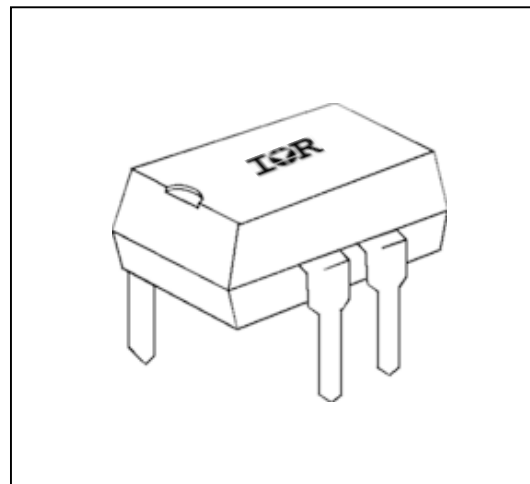

Part Identification

Part Number	Operating Voltage (AC/DC)	Sensitivity	Off-State Resistance
PVA1052	0 – 100V	5 mA	10 ⁸ Ohms
PVA1054			10 ¹⁰ Ohms

(BOSFET is a trademark of International Rectifier)

Electrical Specifications ($-40^{\circ}\text{C} \leq T_A \leq +85^{\circ}\text{C}$ unless otherwise specified)

INPUT CHARACTERISTICS	PVA1052	PVA1054	Units
Minimum Control Current (see figures 1 and 2)			DC
For 25mA Continuous Load Current	2.0		mA@25°C
For 50mA Continuous Load Current	5.0		mA@40°C
For 15mA Continuous Load Current	5.0		mA@80°C
Maximum Control Current for Off-State Resistance at 25°C	10		μA(DC)
Control Current Range (Caution: current limit input LED. See figure 6)	2.0 to 25		mA(DC)
Maximum Reverse Voltage	7.0		V(DC)

OUTPUT CHARACTERISTICS	PVA1052	PVA1054	Units
Operating Voltage Range	0 to ± 100		V _(peak)
Maximum Load Current 40°C (see figures 1 and 2)	70		mA(DC)
Response Time @25°C (see figures 7 and 8)			
Maximum T _(on) @ 12mA Control, 50 mA Load, 50 VDC	25		μs
Maximum T _(off) @ 12mA Control, 50 mA Load, 50 VDC	15		μs
Maximum On-state Resistance 25°C (Pulsed) (figure 4) 50 mA Load, 5mA Control	35		Ω
Minimum Off-state Resistance 25°C @ 80 VDC (see figure 5)	10 ⁸	10 ¹⁰	Ω
Maximum Thermal Offset Voltage @ 5.0mA Control	0.2		μvolts
Minimum Off-State dv/dt	1000		V/μs
Output Capacitance (see figure 9)	3		pF @ 50VDC

GENERAL CHARACTERISTICS (PVA1052 and PVA1054)		Units	
Dielectric Strength: Input-Output		2500	V _{RMS}
Insulation Resistance: Input-Output @ 90V _{DC}		10 ¹² @ 25°C - 50% RH	Ω
Maximum Capacitance: Input-Output		1.0	pF
Max. Pin Soldering Temperature (1.6mm below seating plane, 10 seconds max.)		+260	°C
Ambient Temperature Range:	Operating	-40 to +85	
	Storage	-40 to +100	

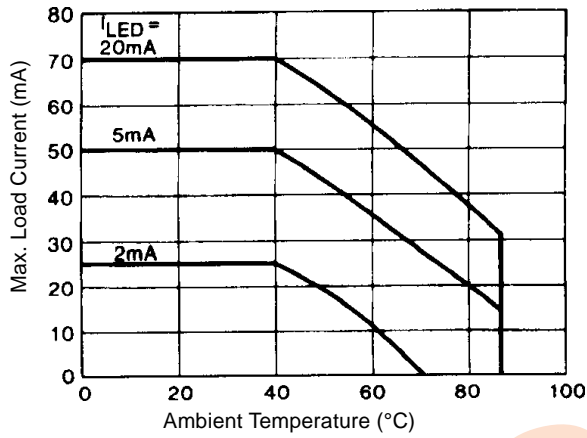

Figure 1. Current Derating Curves

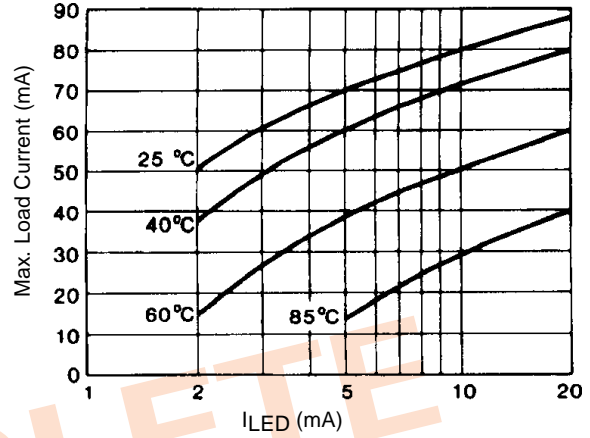

Figure 2. Typical Control Current Requirements

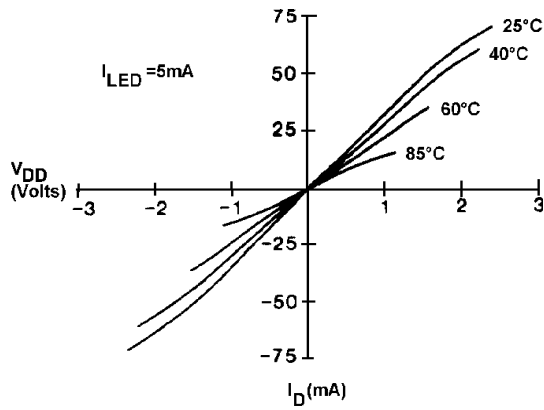

Figure 3. Typical On Characteristics

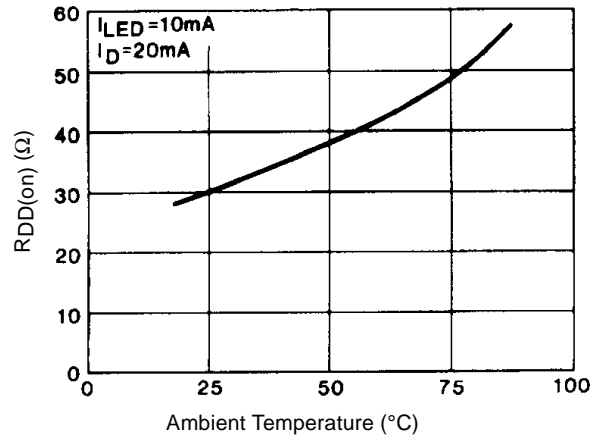

Figure 4. Typical On-Resistance

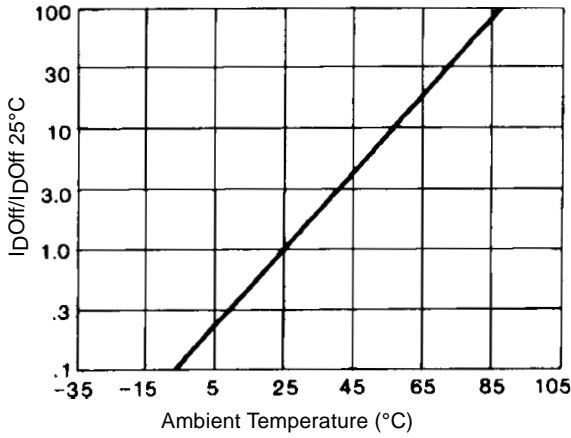

Figure 5. Normalized Off-State Leakage

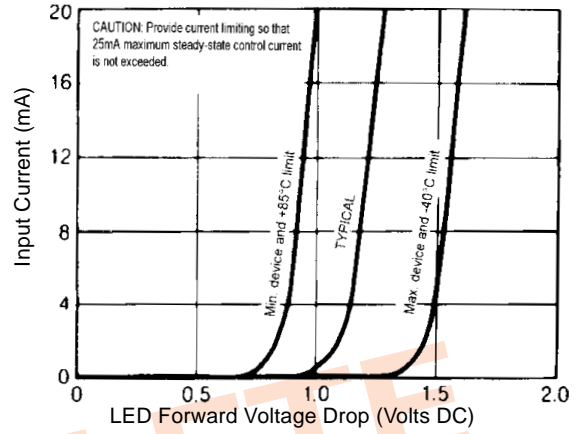

Figure 6. Input Characteristics
 (Current Controlled)

OBSOLETE

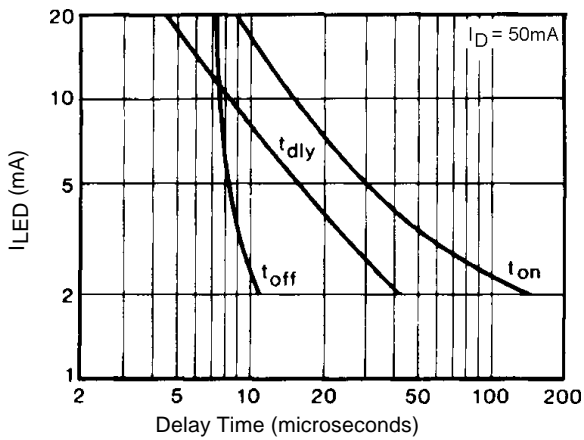

Figure 7. Typical Delay Times

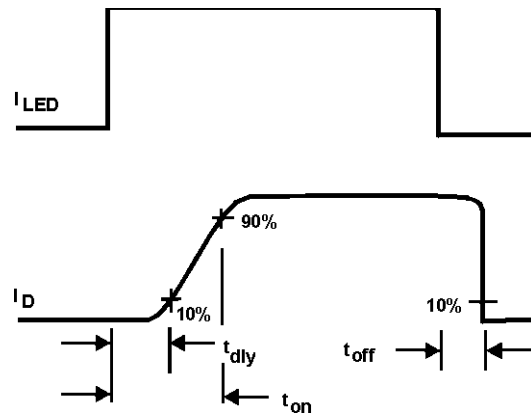

Figure 8. Delay Time Definitions

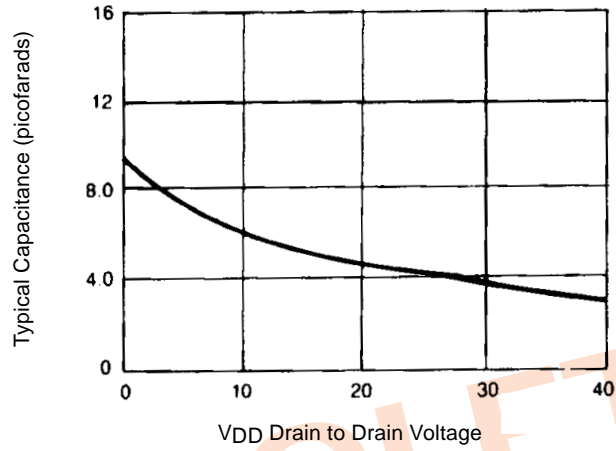

Figure 9. Typical Output Capacitance

OBSOLETE

Wiring Diagram

