



GaAs MMIC FUNDAMENTAL MIXER, 3 - 10 GHz

Typical Applications

The HMC787LC3B is ideal for:

- WiMAX Infrastructure
- Microwave Radio
- ISM & UWB Radios
- Test Equipment & Sensors
- Military End-Use

Features

- Passive Double-Balanced Topology
- High LO/RF Isolation: 55 dB
- Low Conversion Loss: 9 dB
- Wide IF Bandwidth: DC - 4 GHz
- No External Matching Required
- 12 Lead 3x3 mm SMT Package: 9 mm²

Functional Diagram

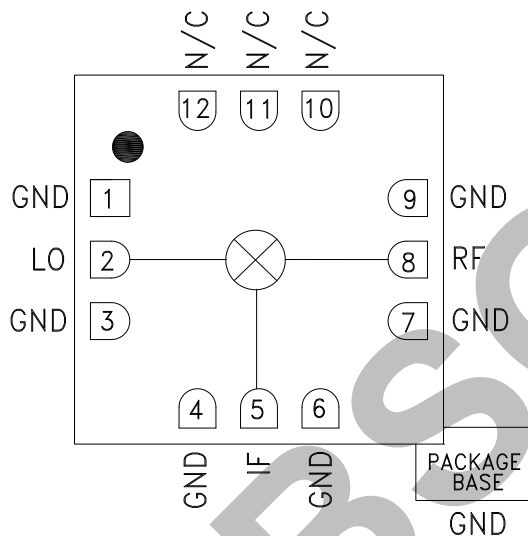

General Description

The HMC787LC3B is a general purpose double balanced mixer in a leadless RoHS compliant SMT package that can be used as an upconverter or downconverter between 3 and 10 GHz. This mixer is fabricated in a GaAs MESFET process, and requires no external components or matching circuitry. The HMC787LC3B provides excellent LO to RF and LO to IF isolation due to optimized balun structures and operates with LO drive level of +17 dBm. The ceramic SMT package eliminates the need for wire bonding, and is compatible with high volume surface mount manufacturing techniques.

Electrical Specifications, $T_A = +25^\circ\text{C}$, $IF = 100\text{ MHz}$, $LO = +17\text{ dBm}^*$

Parameter	Min.	Typ.	Max.	Units
Frequency Range, RF & LO		3 - 10		GHz
Frequency Range, IF		DC - 4		GHz
Conversion Loss		9	11.5	dB
Noise Figure (SSB)		9		dB
LO to RF Isolation		55		dB
LO to IF Isolation	35	42		dB
RF to IF Isolation	13	20		dB
IP3 (Input)		23		dBm
IP2 (Input)		70		dBm
1 dB Gain Compression (Input)		15		dBm

*Unless otherwise noted, all measurements performed as downconverter, $IF = 100\text{ MHz}$.



GaAs MMIC FUNDAMENTAL MIXER, 3 - 10 GHz

Conversion Gain vs. Temperature
 @ LO = +17 dBm, IF Frequency = 100 MHz

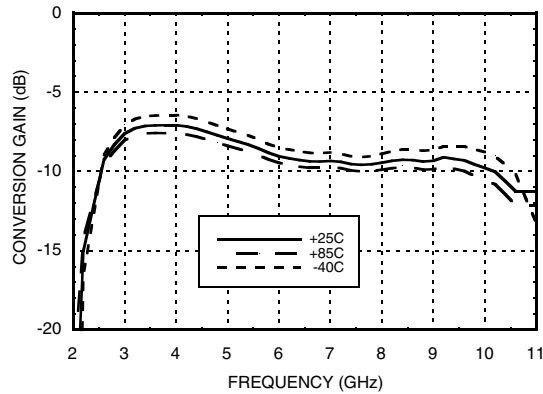

Conversion Loss vs. LO Drive
 @ LO = +17 dBm, IF Frequency = 100 MHz

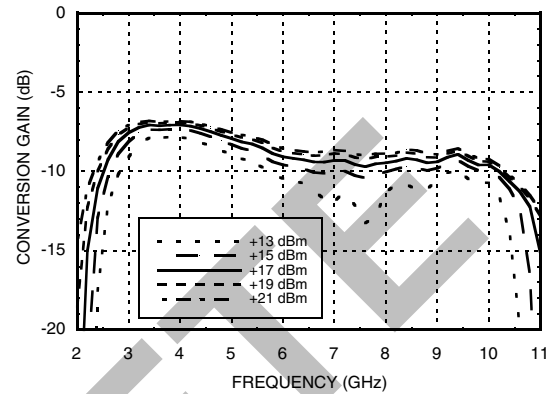

Conversion Gain vs. LO Drive, LSB
 IF Frequency = 1100 MHz

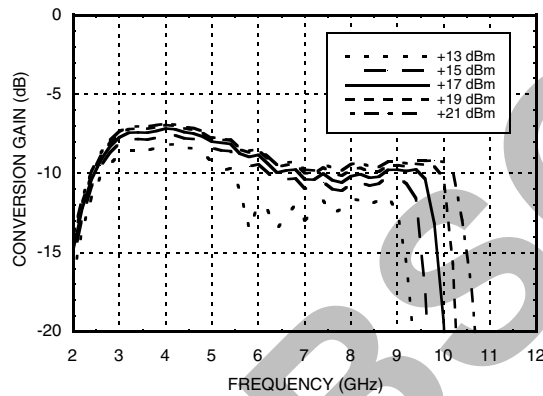

Conversion Loss vs. LO Drive, LSB
 IF Frequency = 3100 MHz

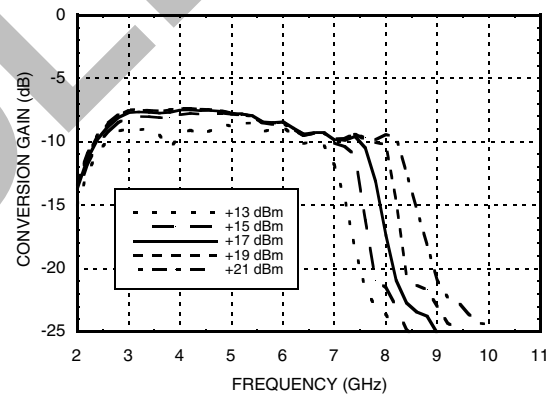

Isolation @ LO = +17 dBm

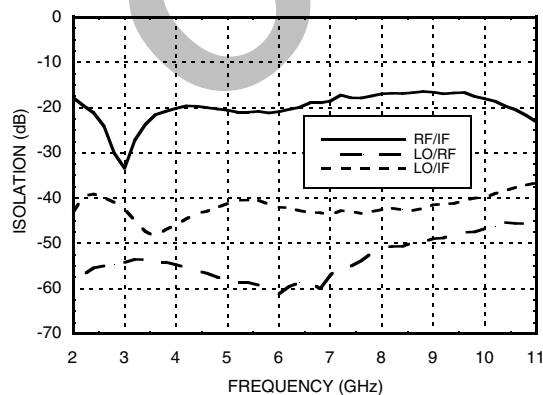

Return Loss @ LO = +17 dBm

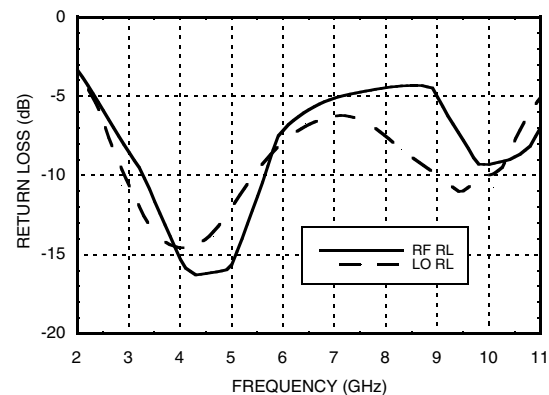



GaAs MMIC FUNDAMENTAL MIXER, 3 - 10 GHz

MIXERS - SINGLE & DOUBLE BALANCED - SMT

IF Bandwidth @ LO = +17 dBm

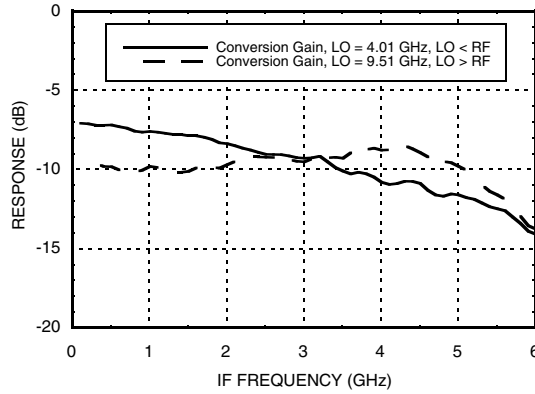

Upconverter Performance Conversion Gain vs. LO Drive, IF Frequency 100 MHz

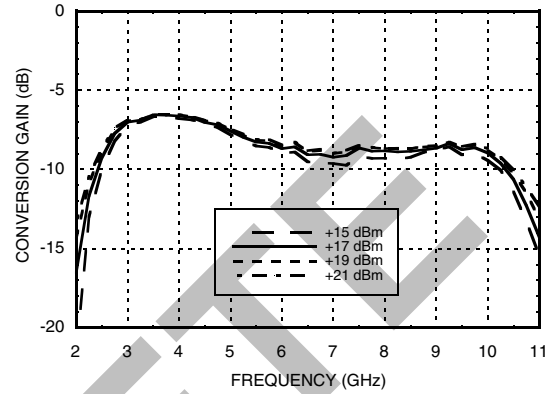

Upconverter Performance Conversion Gain vs. LO Drive LSB, IF Frequency 1100 MHz

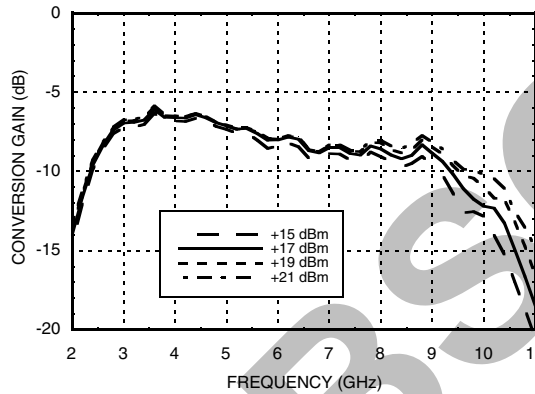

Upconverter Performance Conversion Gain vs. LO Drive LSB, IF Frequency 3100 MHz

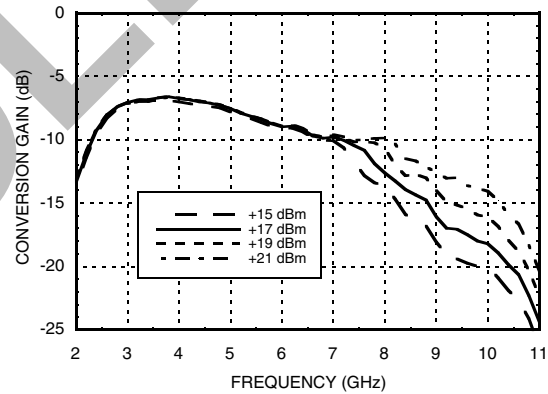

Input IP3 vs. Temperature @ LO = +17 dBm *, IF Frequency = 100 MHz

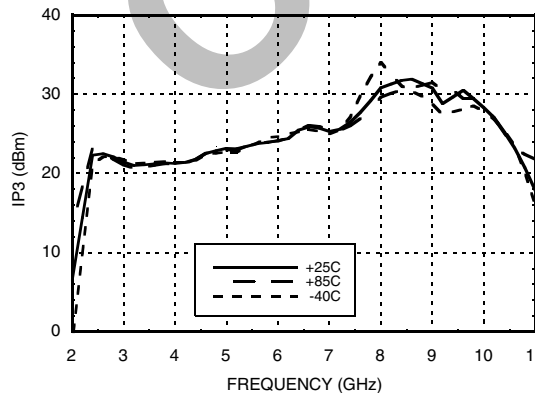

Input IP3 vs. LO Drive*, IF Frequency = 100 MHz

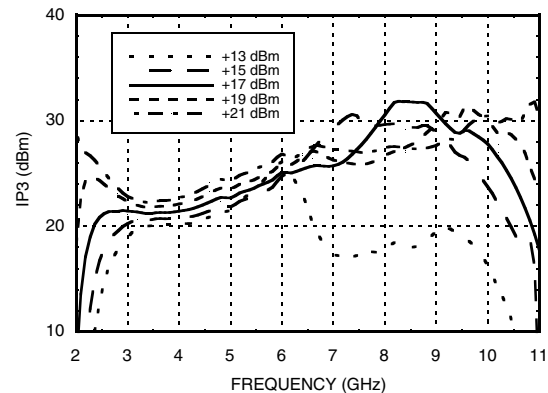

* Two-tone input power = -10 dBm each tone, 1 MHz spacing.

Information furnished by Analog Devices is believed to be accurate and reliable. However, no responsibility is assumed by Analog Devices for its use, nor for any infringements of patents or other rights of third parties that may result from its use. Specifications subject to change without notice. No license is granted by implication or otherwise under any patent or patent rights of Analog Devices. Trademarks and registered trademarks are the property of their respective owners.

For price, delivery, and to place orders: Analog Devices, Inc., One Technology Way, P.O. Box 9106, Norwood, MA 02062-9106 Phone: 781-329-4700 • Order online at www.analog.com Application Support: Phone: 1-800-ANALOG-D



GaAs MMIC FUNDAMENTAL MIXER, 3 - 10 GHz

Input IP3 vs. LO Drive* LSB, IF Frequency = 1100 MHz

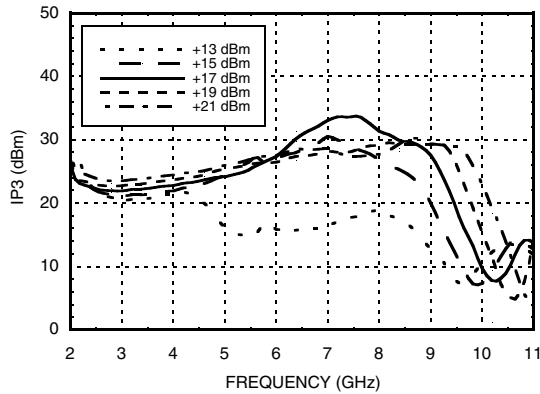

Input IP3 vs. LO Drive* LSB, IF Frequency = 3100 MHz

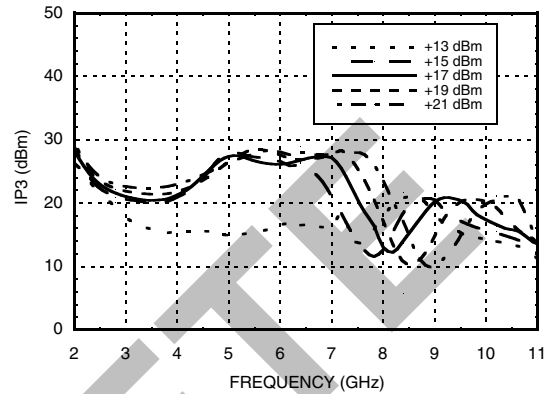

Input IP2 vs. LO Drive *

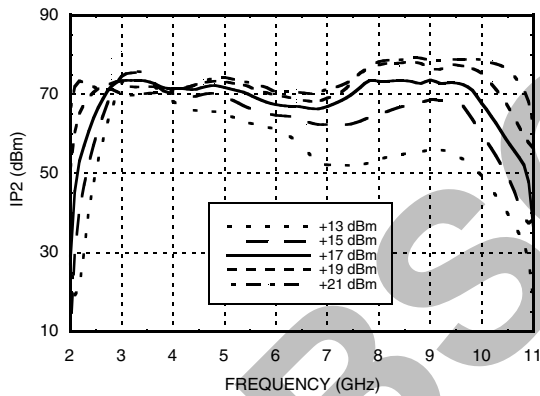

Input IP2 vs. Temperature @ LO = +17 dBm *

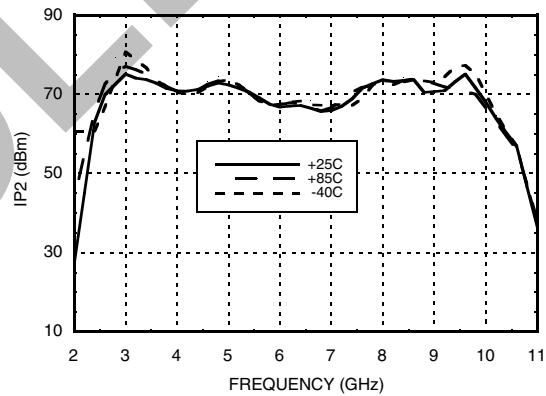

Input P1dB vs. Temperature @ LO = +17 dBm

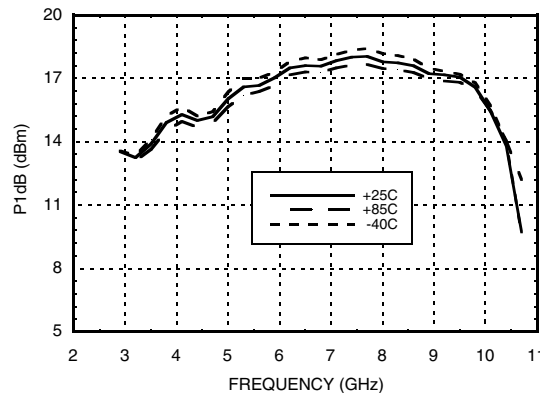

* Two-tone input power = -10 dBm each tone, 1 MHz spacing.



GaAs MMIC FUNDAMENTAL MIXER, 3 - 10 GHz

MxN Spurious Outputs

mRF	nLO				
	0	1	2	3	4
0	xx	16	38	34	54
1	23	0	37	23	38
2	92	73	89	71	85
3	77	66	68	62	71
4	xx	xx	xx	108	115

RF = 3.1 GHz @ -5 dBm
LO = 3 GHz @ +17 dBm
All values in dBc below the IF output power level.

MxN Spurious Outputs

mRF	nLO				
	0	1	2	3	4
0	xx	13	34	55	73
1	24	0	32	41	68
2	86	72	86	80	102
3	80	58	94	83	99
4	xx	xx	xx	xx	xx

RF = 3.1 GHz @ -5 dBm
LO = 6.1 GHz @ +17 dBm
All values in dBc below the IF output power level.

MxN Spurious Outputs

mRF	nLO				
	0	1	2	3	4
0	xx	15	37	29	49
1	12	0	29	14	49
2	89	77	89	78	97
3	103	85	102	83	88
4	107	xx	xx	xx	xx

RF = 6.1 GHz @ -5 dBm
LO = 3.1 GHz @ +17 dBm
All values in dBc below the IF output power level.

MxN Spurious Outputs

mRF	nLO				
	0	1	2	3	4
0	xx	11	33	56	61
1	11	0	32	54	59
2	88	69	79	67	93
3	105	101	84	72	89
4	108.45	xx	xx	xx	xx

RF = 6.1 GHz @ -5 dBm
LO = 6 GHz @ +17 dBm
All values in dBc below the IF output power level.

MxN Spurious Outputs

mRF	nLO				
	0	1	2	3	4
0	xx	11	27	45	60
1	7	0	45	43	61
2	91	74	82	87	96
3	105	89	99	83	85
4	xx	xx	xx	xx	xx

RF = 10.1 GHz @ -5 dBm
LO = 7.1 GHz @ +17 dBm
All values in dBc below the IF output power level.

MxN Spurious Outputs

mRF	nLO				
	0	1	2	3	4
0	xx	7	35	47	69
1	7	0	27	55	84
2	91	76	83	73	105
3	109	98	87	80	88
4	xx	xx	xx	xx	86

RF = 10.1 GHz @ -5 dBm
LO = 10 GHz @ +17 dBm
All values in dBc below the IF output power level.



GaAs MMIC FUNDAMENTAL MIXER, 3 - 10 GHz

Absolute Maximum Ratings

RF / IF Input	+26 dBm
LO Drive	+26 dBm
Channel Temperature	150 °C
Continuous Pdiss (T = 85 °C) (derate 11.4 mW/°C above 85 °C)	0.74 mW
Thermal Resistance (channel to ground paddle)	87.7 °C/W
Storage Temperature	-65 to +150 °C
Operating Temperature	-40 to +85 °C

Harmonics of LO

LO Freq. (GHz)	nLO Spur @ RF Port			
	1	2	3	4
3	56	53	71	73
6	61	58	77	87
10	46	62	84	73

LO = +17 dBm
All values in dBc below input LO level measured at RF port.



**ELECTROSTATIC SENSITIVE DEVICE
OBSERVE HANDLING PRECAUTIONS**

Outline Drawing

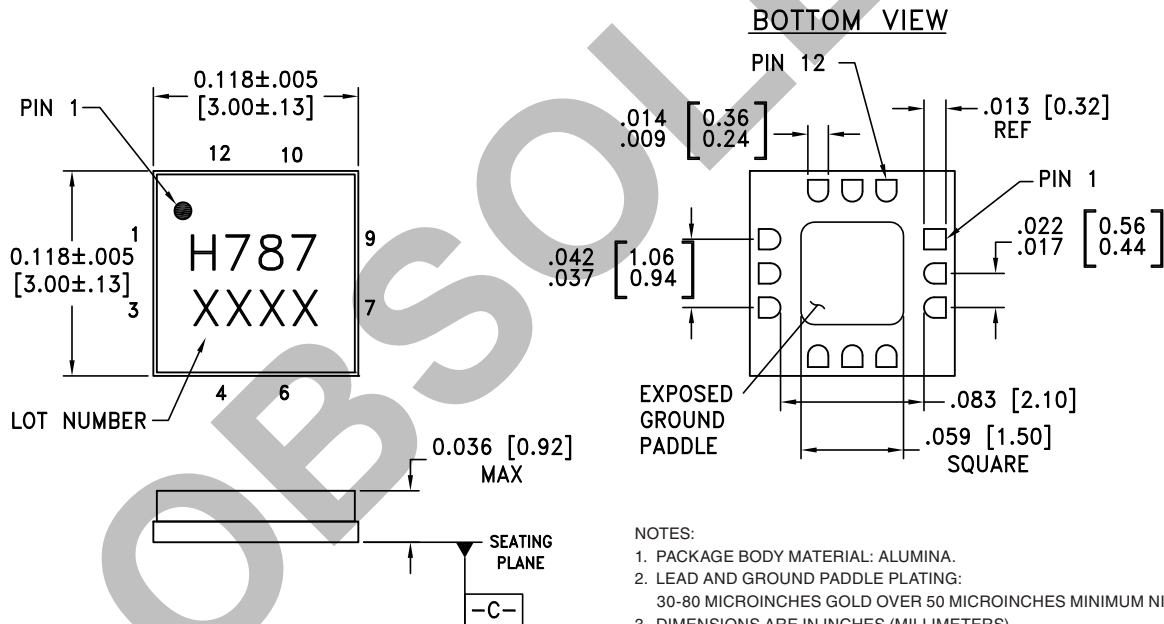

NOTES:

1. PACKAGE BODY MATERIAL: ALUMINA.
2. LEAD AND GROUND PADDLE PLATING:
30-80 MICROINCHES GOLD OVER 50 MICROINCHES MINIMUM NICKEL.
3. DIMENSIONS ARE IN INCHES (MILLIMETERS).
4. LEAD SPACING TOLERANCE IS NON-CUMULATIVE.
5. CHARACTERS TO BE HELVETICA MEDIUM, .025 HIGH, BLACK INK, OR LASER MARK LOCATED APPROX. AS SHOWN.
6. PACKAGE WARP SHALL NOT EXCEED 0.05MM DATUM - C -
7. ALL GROUND LEADS AND GROUND PADDLE MUST BE SOLDERED TO PCB RF GROUND.

Package Information

Part Number	Package Body Material	Lead Finish	MSL Rating	Package Marking ^[2]
HMC787LC3B	Alumina, White	Gold over Nickel	MSL3 ^[1]	H787 XXXX

[1] Max peak reflow temperature of 260 °C

[2] 4-Digit lot number XXXX



GaAs MMIC FUNDAMENTAL MIXER, 3 - 10 GHz

Pin Descriptions

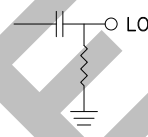
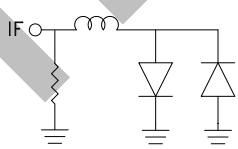
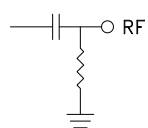
Pin Number	Function	Description	Interface Schematic
1, 3, 4, 6, 7, 9	GND	Package bottom must also be connected to RF/DC ground.	
2	LO	This pin is DC coupled and matched to 50 Ohms.	
5	IF	This pin is DC coupled. For applications not requiring operation to DC, this port should be DC blocked externally using a series capacitor whose value has been chosen to pass the necessary IF frequency range. For operation to DC, this pin must not source or sink more than 8 mA of current or part non-function and possible part failure will result.	
8	RF	This pin is DC coupled and matched to 50 Ohms.	
10, 11, 12	N/C	The pins are not connected internally; however, all data shown herein was measured with these pins connected to RF/DC ground externally.	



Evaluation PCB

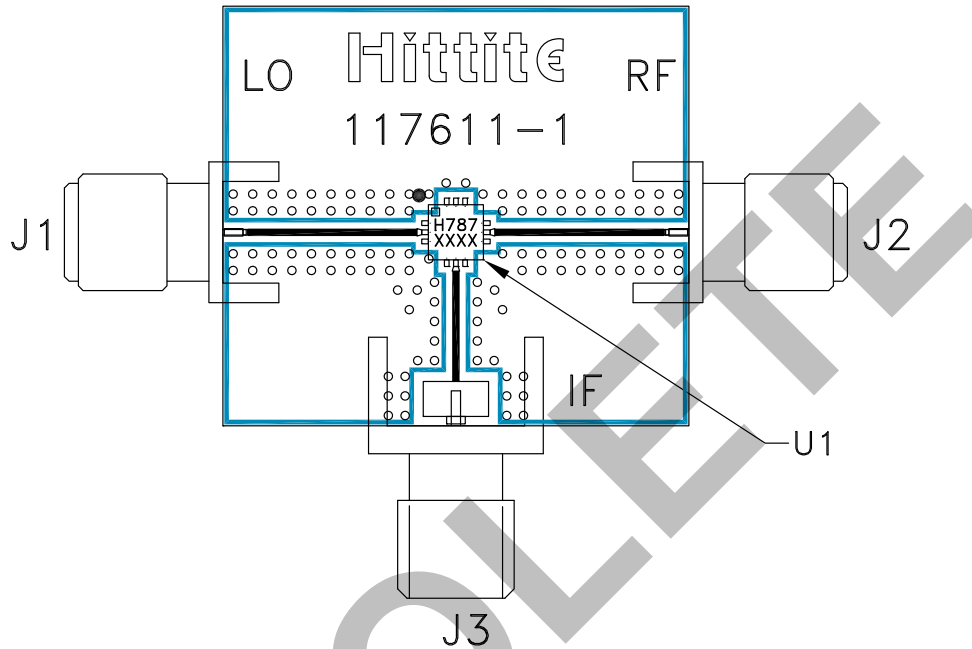

List of Materials for Evaluation PCB 109952 [1]

Item	Description
J1 - J2	SRI SMA Connector
J3	Johnson SMA Connector
U1	HMC787LC3B Mixer
PCB [2]	117611 Evaluation PCB

[1] Reference this number when ordering complete evaluation PCB

[2] Circuit Board Material: Arlon 25 RF

The circuit board used in this application should use RF circuit design techniques. Signal lines should have 50 Ohm impedance while the package ground leads and exposed paddle should be connected directly to the ground plane similar to that shown. A sufficient number of via holes should be used to connect the top and bottom ground planes. The evaluation circuit board shown is available from Hittite upon request.