

GenX3™ 600V IGBT w/ SiC Anti-Parallel Diode

IXGH36N60B3C1

Medium Speed Low Vsat PT
IGBT for 5 - 40kHz Switching

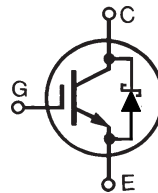

$$\begin{aligned} V_{CES} &= 600V \\ I_{C110} &= 36A \\ V_{CE(sat)} &\leq 1.8V \\ t_{fi(typ)} &= 100ns \end{aligned}$$

TO-247

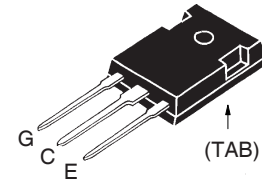

G = Gate C = Collector
E = Emitter TAB = Collector

Symbol	Test Conditions	Maximum Ratings	
V_{CES}	$T_J = 25^\circ\text{C to } 150^\circ\text{C}$	600	V
V_{CGR}	$T_J = 25^\circ\text{C to } 150^\circ\text{C}, R_{GE} = 1M\Omega$	600	V
V_{GES}	Continuous	± 20	V
V_{GEM}	Transient	± 30	V
I_{C25}	$T_C = 25^\circ\text{C}$ (Limited by Leads)	75	A
I_{C110}	$T_C = 110^\circ\text{C}$	36	A
I_{F110}	$T_C = 110^\circ\text{C}$	20	A
I_{CM}	$T_C = 25^\circ\text{C}, 1\text{ms}$	200	A
SSOA (RBSOA)	$V_{GE} = 15\text{V}, T_{VJ} = 125^\circ\text{C}, R_G = 5\Omega$ Clamped Inductive Load	$I_{CM} = 80$ @ $\leq V_{CES}$	A
P_C	$T_C = 25^\circ\text{C}$	250	W
T_J		-55 ... +150	$^\circ\text{C}$
T_{JM}		150	$^\circ\text{C}$
T_{stg}		-55 ... +150	$^\circ\text{C}$
T_L	1.6mm (0.062 in.) from Case for 10 seconds	300	$^\circ\text{C}$
T_{SOLD}	Plastic Body for 10 seconds	260	$^\circ\text{C}$
M_d	Mounting Torque	1.13/10	Nm/lb.in.
Weight		6	g

Features

- Optimized for Low Conduction and Switching Losses
- Square RBSOA
- Anti-Parallel Schottky Diode
- International Standard Package

Advantages

- High Power Density
- Low Gate Drive Requirement

Applications

- Power Inverters
- UPS
- Motor Drives
- SMPS
- PFC Circuits
- Battery Chargers
- Welding Machines
- Lamp Ballasts

Symbol	Test Conditions ($T_J = 25^\circ\text{C}$ Unless Otherwise Specified)	Characteristic Values		
		Min.	Typ.	Max.
$V_{GE(th)}$	$I_C = 250\mu\text{A}, V_{CE} = V_{GE}$	3.0		5.0 V
I_{CES}	$V_{CE} = V_{CES}, V_{GE} = 0\text{V}$ $T_J = 125^\circ\text{C}$			35 μA 1.25 mA
I_{GES}	$V_{CE} = 0\text{V}, V_{GE} = \pm 20\text{V}$			± 100 nA
$V_{CE(sat)}$	$I_C = 30\text{A}, V_{GE} = 15\text{V}, \text{Note 1}$		1.5	1.8 V

Symbol	Test Conditions ($T_J = 25^\circ\text{C}$, Unless Otherwise Specified)	Characteristic Values		
		Min.	Typ.	Max.
g_{fs}	$I_C = 30\text{A}, V_{CE} = 10\text{V}$, Note 1	28	42	S
C_{ies}	$V_{CE} = 25\text{V}, V_{GE} = 0\text{V}, f = 1\text{MHz}$		2430	pF
C_{oes}			390	pF
C_{res}			28	pF
Q_g	$I_C = 30\text{A}, V_{GE} = 15\text{V}, V_{CE} = 0.5 \cdot V_{CES}$		80	nC
Q_{ge}			12	nC
Q_{gc}			36	nC
$t_{d(on)}$	Inductive load, $T_J = 25^\circ\text{C}$ $I_C = 30\text{A}, V_{GE} = 15\text{V}$ $V_{CE} = 400\text{V}, R_G = 5\Omega$ Note 2		20	ns
t_{ri}			26	ns
E_{on}			0.39	mJ
$t_{d(off)}$			125	200 ns
t_{fi}			100	160 ns
E_{off}			0.80	1.50 mJ
$t_{d(on)}$	Inductive load, $T_J = 125^\circ\text{C}$ $I_C = 30\text{A}, V_{GE} = 15\text{V}$ $V_{CE} = 400\text{V}, R_G = 5\Omega$ Note 2		20	ns
t_{ri}			27	ns
E_{on}			0.43	mJ
$t_{d(off)}$			180	ns
t_{fi}			170	ns
E_{off}			1.50	mJ
R_{thJC}			0.50	$^\circ\text{C/W}$
R_{thCS}		0.21		$^\circ\text{C/W}$

TO-247 Outline

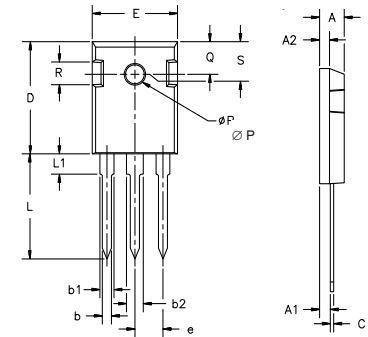

Dim.	Millimeter		Inches	
	Min.	Max.	Min.	Max.
A	4.7	5.3	.185	.209
A ₁	2.2	2.54	.087	.102
A ₂	2.2	2.6	.059	.098
b	1.0	1.4	.040	.055
b ₁	1.65	2.13	.065	.084
b ₂	2.87	3.12	.113	.123
C	.4	.8	.016	.031
D	20.80	21.46	.819	.845
E	15.75	16.26	.610	.640
e	5.20	5.72	0.205	0.225
L	19.81	20.32	.780	.800
L1		4.50		.177
∅P	3.55	3.65	.140	.144
Q	5.89	6.40	0.232	0.252
R	4.32	5.49	.170	.216
S	6.15	BSC	.242	BSC

Reverse Diode (SiC)

Symbol	Test Conditions ($T_J = 25^\circ\text{C}$ Unless Otherwise Specified)	Characteristic Values		
		Min.	Typ.	Max.
V_F	$I_F = 20\text{A}, V_{GE} = 0\text{V}$, Note 1 $T_J = 125^\circ\text{C}$		1.65	2.10 V
			1.80	V
R_{thJC}				0.90 $^\circ\text{C/W}$

Notes

1. Pulse test, $t \leq 300\mu\text{s}$, duty cycle, $d \leq 2\%$.
2. Switching times & energy losses may increase for higher V_{CE} (Clamp), T_J or R_G .

PRELIMINARY TECHNICAL INFORMATION

The product presented herein is under development. The Technical Specifications offered are derived from data gathered during objective characterizations of preliminary engineering lots; but also may yet contain some information supplied during a pre-production design evaluation. IXYS reserves the right to change limits, test conditions, and dimensions without notice.

IXYS Reserves the Right to Change Limits, Test Conditions, and Dimensions.

IXYS MOSFETs and IGBTs are covered by one or more of the following U.S. patents:	4,835,592	4,931,844	5,049,961	5,237,481	6,162,665	6,404,065 B1	6,683,344	6,727,585	7,005,734 B2	7,157,338B2
	4,850,072	5,017,508	5,063,307	5,381,025	6,259,123 B1	6,534,343	6,710,405 B2	6,759,692	7,063,975 B2	
	4,881,106	5,034,796	5,187,117	5,486,715	6,306,728 B1	6,583,505	6,710,463	6,771,478 B2	7,071,537	

**Fig. 1. Output Characteristics
@ 25°C**

**Fig. 2. Extended Output Characteristics
@ 25°C**

**Fig. 3. Output Characteristics
@ 125°C**

**Fig. 4. Dependence of $V_{CE(sat)}$ on
Junction Temperature**

**Fig. 5. Collector-to-Emitter Voltage
vs. Gate-to-Emitter Voltage**

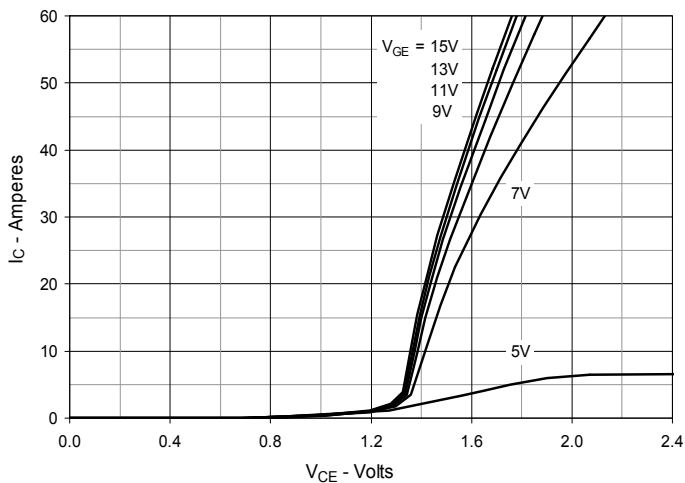
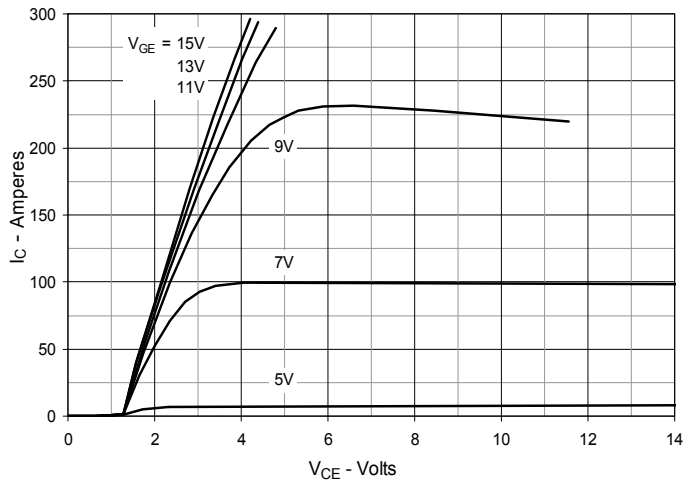
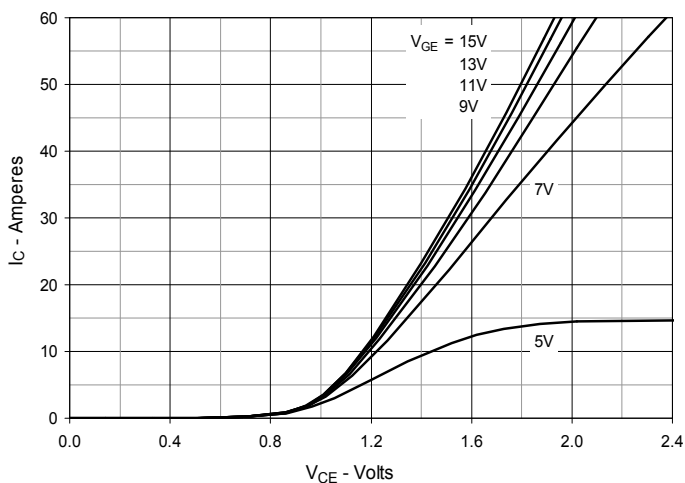
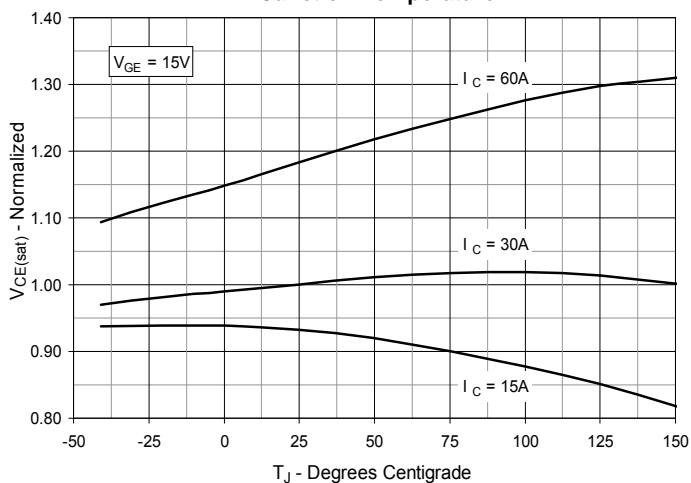
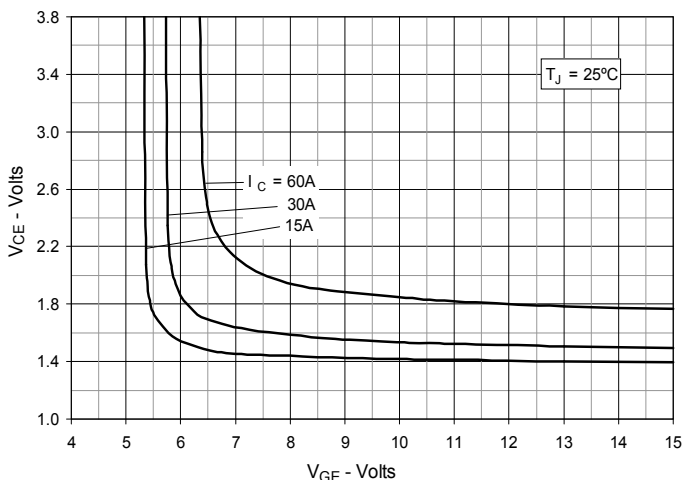
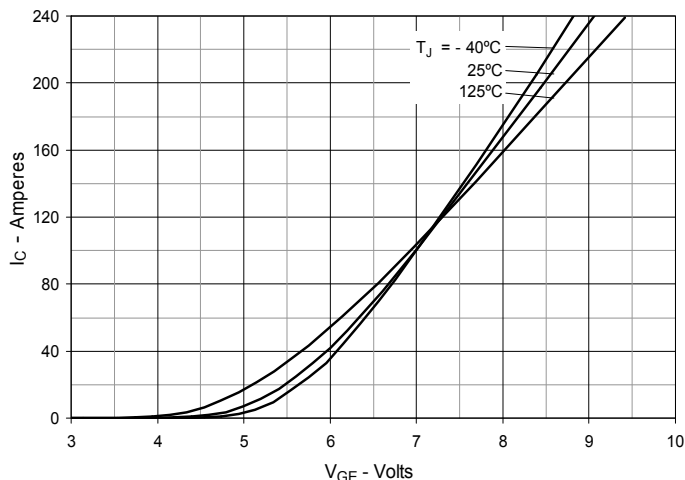
Fig. 6. Input Admittance

Fig. 7. Transconductance

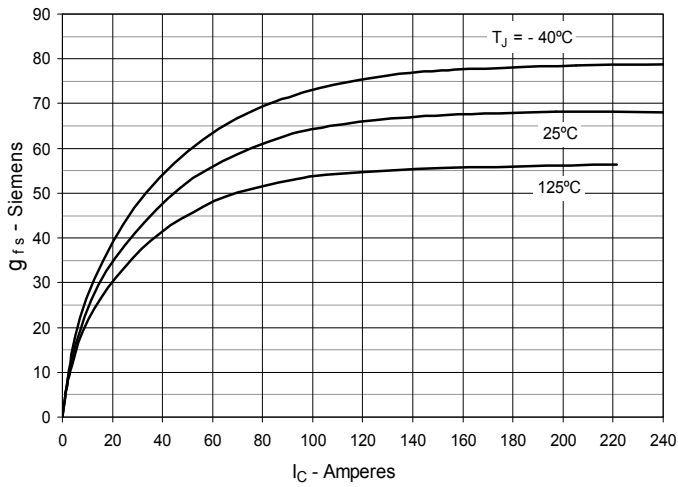

Fig. 8. Gate Charge

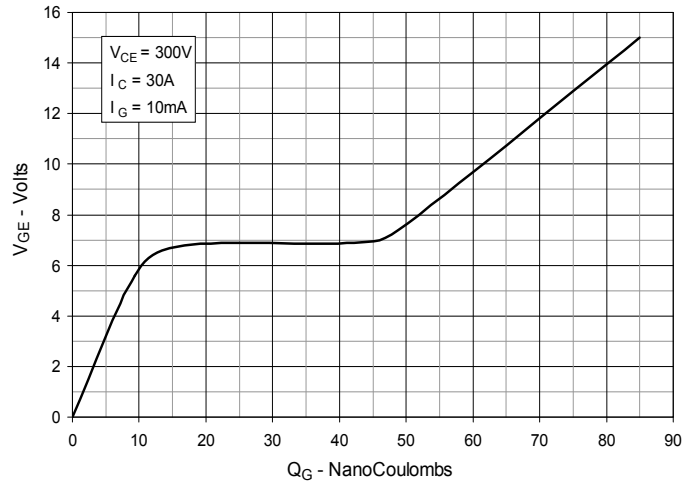

Fig. 9. Capacitance

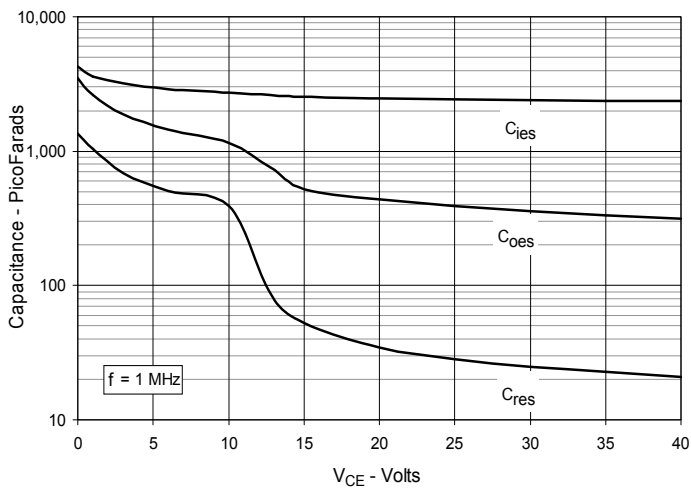

Fig. 10. Reverse-Bias Safe Operating Area

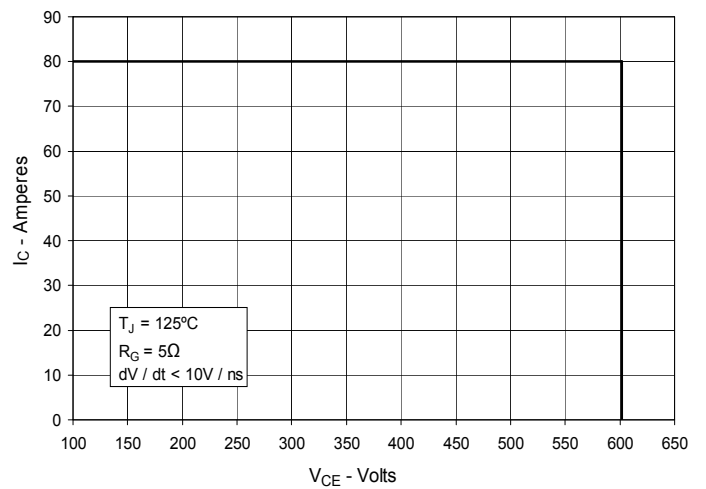

Fig. 11. Maximum Transient Thermal Impedance

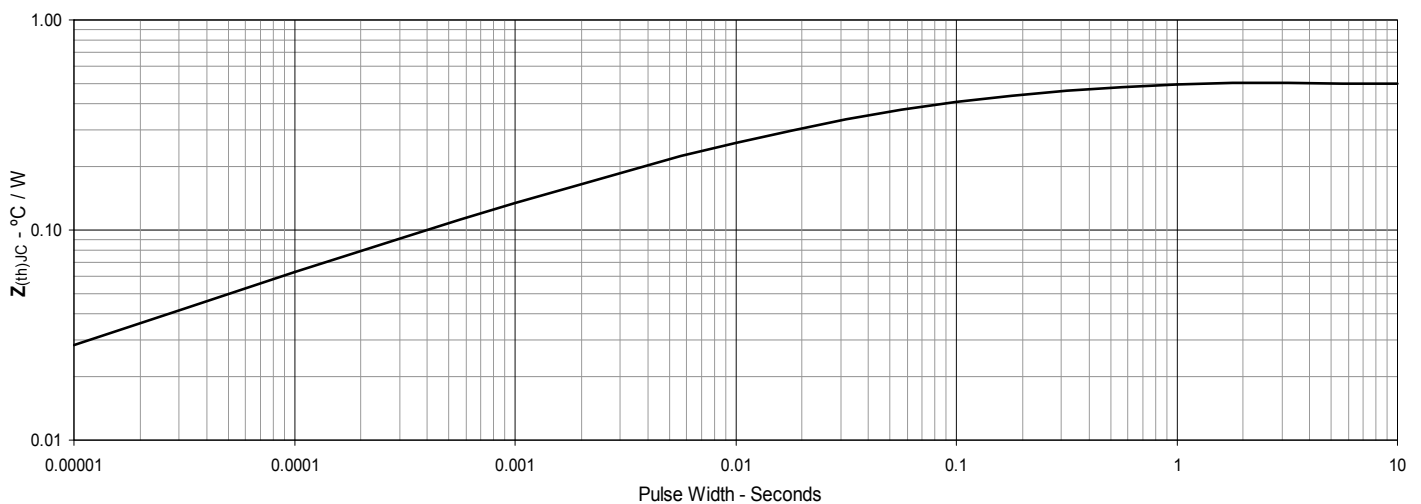

Fig. 12. Inductive Switching Energy Loss vs. Gate Resistance

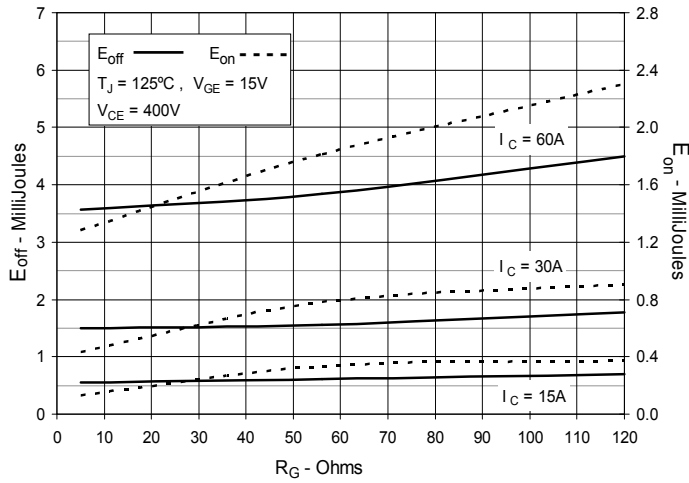

Fig. 13. Inductive Switching Energy Loss vs. Collector Current

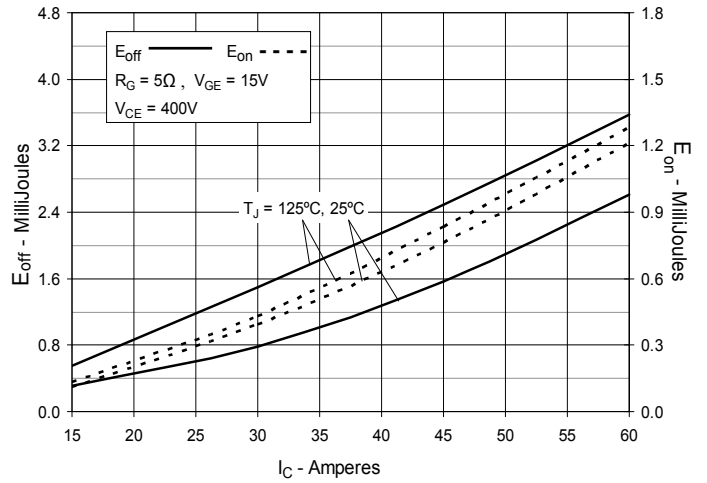

Fig. 14. Inductive Switching Energy Loss vs. Junction Temperature

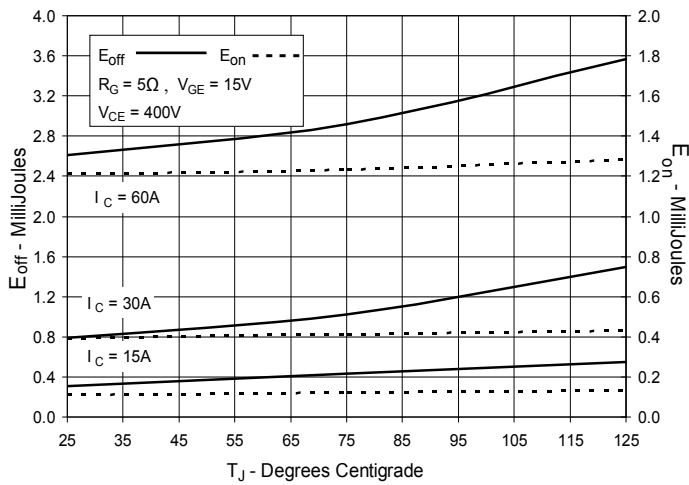

Fig. 15. Inductive Turn-off Switching Times vs. Gate Resistance

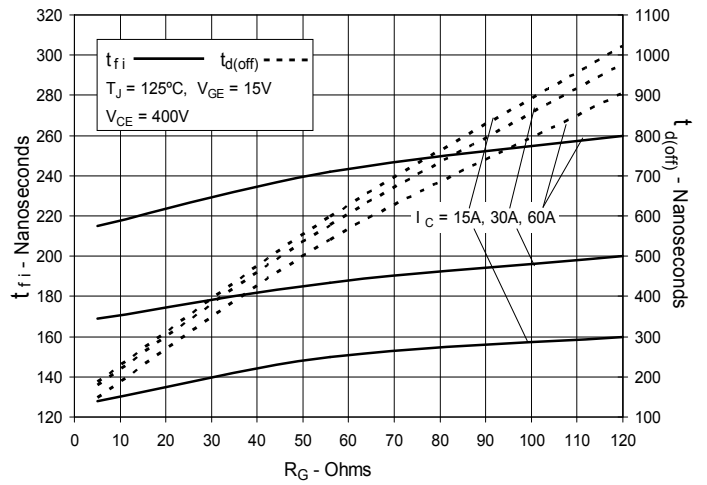

Fig. 16. Inductive Turn-off Switching Times vs. Collector Current

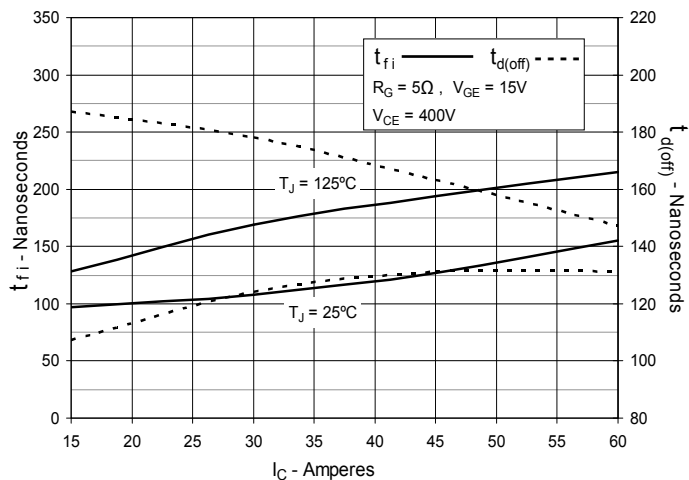

Fig. 17. Inductive Turn-off Switching Times vs. Junction Temperature

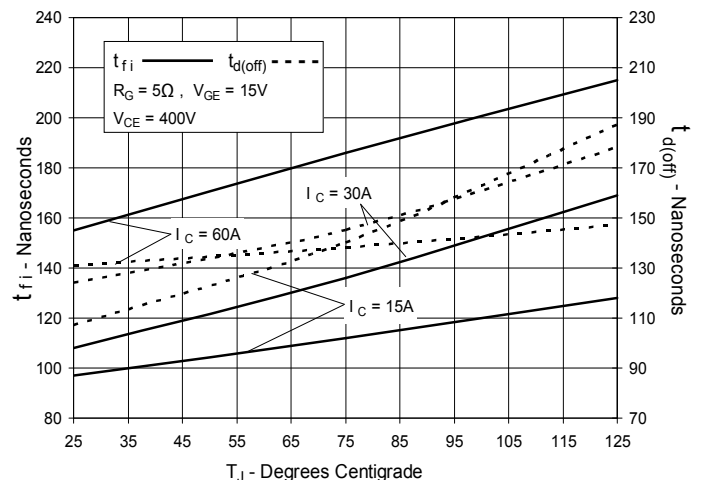
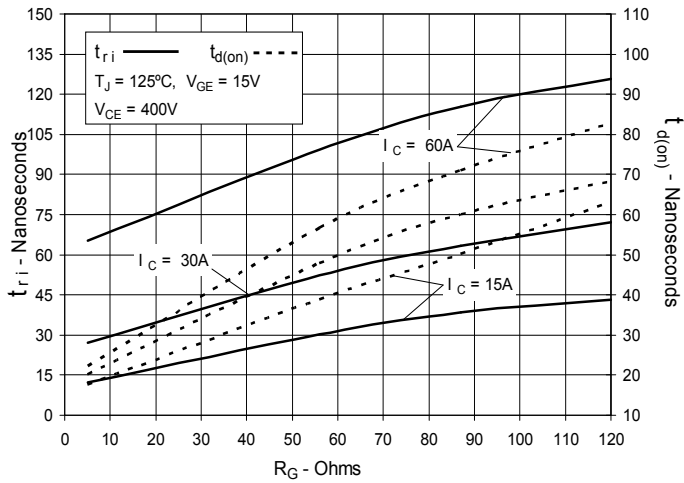
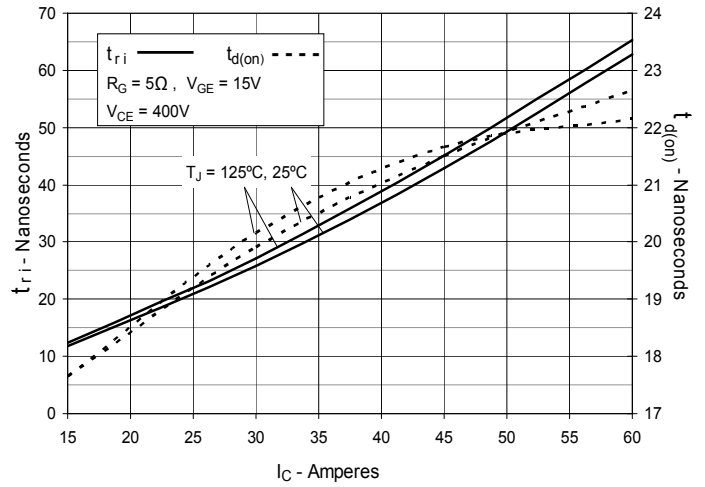
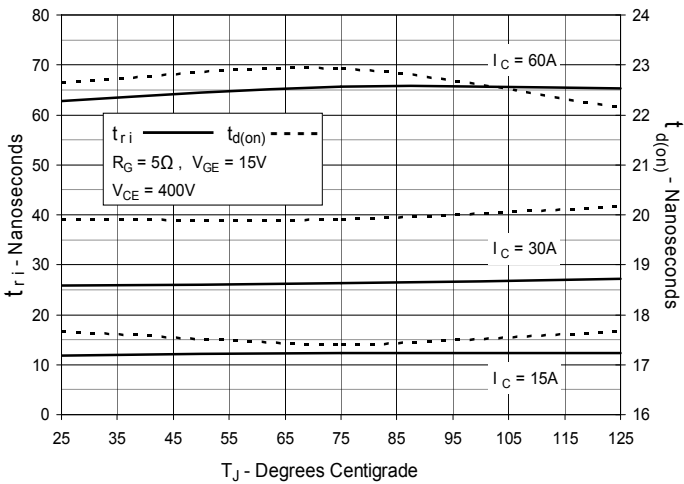
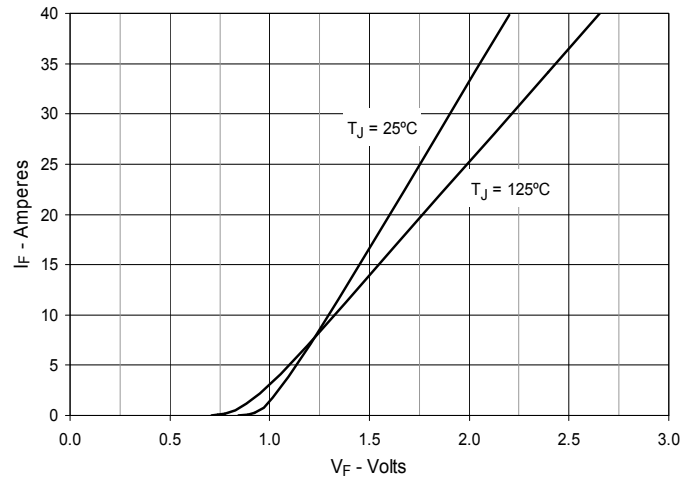
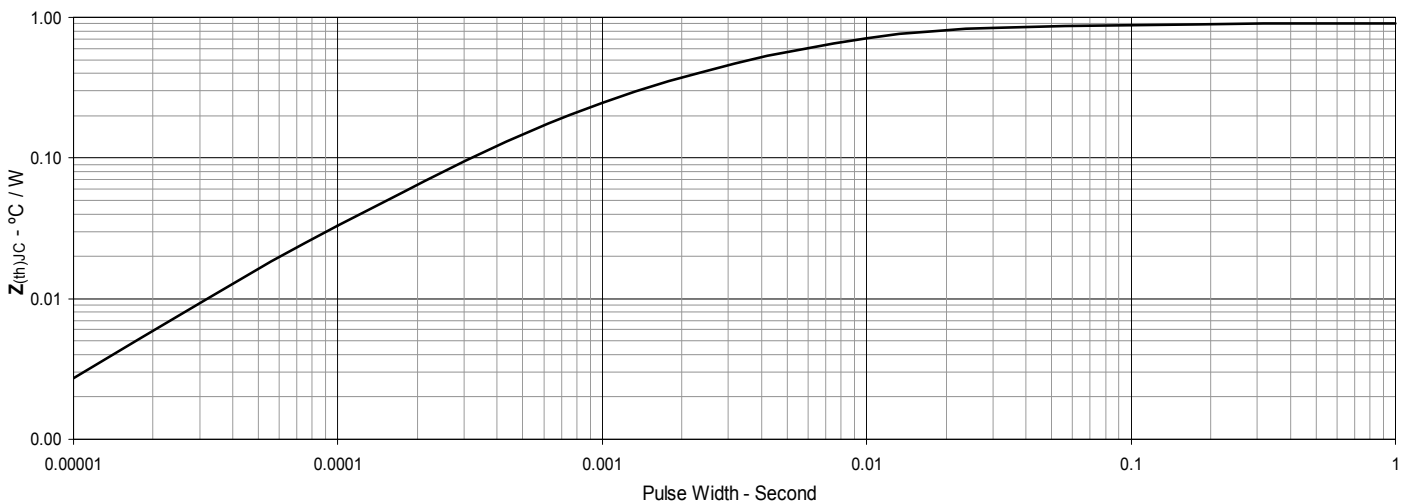

Fig. 18. Inductive Turn-on Switching Times vs. Gate Resistance

Fig. 19. Inductive Turn-on Switching Times vs. Collector Current

Fig. 20. Inductive Turn-on Switching Times vs. Junction Temperature

Fig. 21. Forward Current vs. Forward Voltage

Fig. 22. Maximum Transient Thermal Impedance for Diode



Disclaimer Notice - Information furnished is believed to be accurate and reliable. However, users should independently evaluate the suitability of and test each product selected for their own applications. Littelfuse products are not designed for, and may not be used in, all applications. Read complete Disclaimer Notice at www.littelfuse.com/disclaimer-electronics.