

SPECIFICATIONS
CDSX50 SERIES
PACKAGE DIMENSIONS

CDSC50 SERIES

CDSA50 SERIES
Notes:

1. All dimensions are in millimeters (inches).
2. Tolerance is $\pm 0.25\text{mm}$ ($0.01''$) unless otherwise noted.
3. Specifications are subject to change without notice.

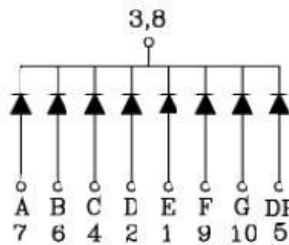
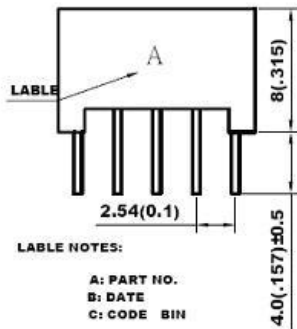
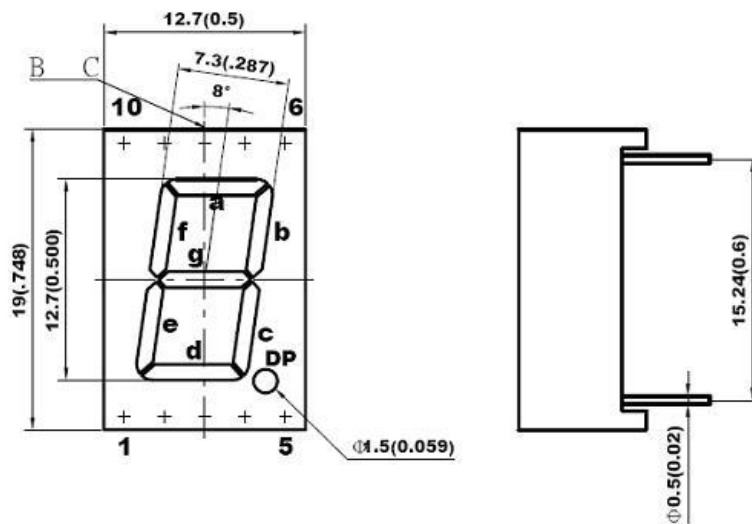
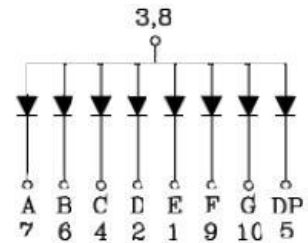

ChromeLED Corp. reserves the right to make changes at any time in order to supply the best product possible. The most current version of this document will always be available at: www.chromeled.com

PART NUMBER DESCRIPTION

Part Number	Chip Material	Color of Emission	Lens Type	Description
CDSA50R1W	GaAsP	Red	White Segment	Common Anode
CDSC50R1W	GaAsP	Red	White Segment	Common Cathode
CDSA50RR1W	AlGaAs	Super Red	White Segment	Common Anode
CDSC50RR1W	AlGaAs	Super Red	White Segment	Common Cathode
CDSA50Y1W	GaAsP	Yellow	White Segment	Common Anode
CDSC50Y1W	GaAsP	Yellow	White Segment	Common Cathode
CDSA50G1W	GaP	Green	White Segment	Common Anode
CDSC50G1W	GaP	Green	White Segment	Common Cathode

OPTICAL-ELECTRICAL CHARACTERISTICS
(TA=25°C)

Part Number	Wave-length (nm)	Absolute Maximum				Electro-Optical Characteristics					
		$\Delta\lambda$	P_D	I_{AF}	I_{PF}	V_F (V)			I_F	I_V (μ cd)	
		nm	mW	mA	(Peak)	Min	Typ	Max	(Rec)	Min	Typ
CDSA50R1W	625	45	75	30	100	1.7	1.85	2.5	10	3000	8000
CDSC50R1W	625	45	75	30	100	1.7	1.85	2.5	10	3000	8000
CDSA50RR1W	640	20	72	30	100	1.6	1.75	2.4	10	5000	18000
CDSC50RR1W	640	20	72	30	100	1.6	1.75	2.4	10	5000	18000
CDSA50Y1W	588	35	75	30	100	1.7	2.1	2.8	10	1900	4700
CDSC50Y1W	588	35	75	30	100	1.7	2.1	2.8	10	1900	4700
CDSA50G1W	568	30	65	25	100	1.7	2.1	2.8	10	3000	10500
CDSC50G1W	568	30	65	25	100	1.7	2.1	2.8	10	3000	10500

ABSOLUTE MAXIMUM RATINGS
(TA=25°C)

Reverse Voltage	5V	Spectral Line half-width (λ)	nm
Reverse Current ($V_r = 5V$)	100 μ A	Power Dissipation (P_D)	mW
Operating Temperature	-40°C~+85°C	Peak Forward Current (Duty 1/10, @ KHz)	mA
Storage Temperature	-40°C~+85°C	Recommended Operation Current (I_F Rec)	mA
Soldering Temperature	250C~260C for 3 sec.	Average Luminous Intensity ($I_F=10$)	μ A



ChromeLED Corp. reserves the right to make changes at any time in order to supply the best product possible. The most current version of this document will always be available at: www.chromeled.com

OPTICAL CHARACTERISTIC CURVES - RED

Forward Current vs. Forward Voltage

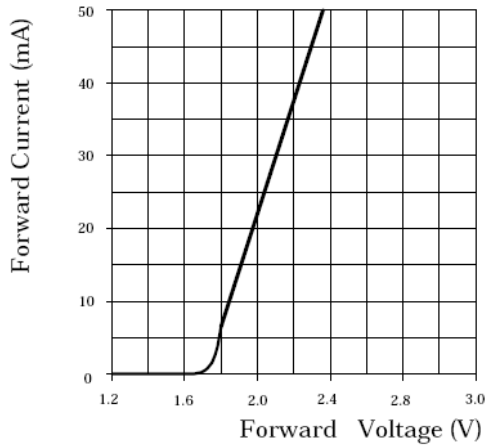

Relative Intensity vs. Forward Current

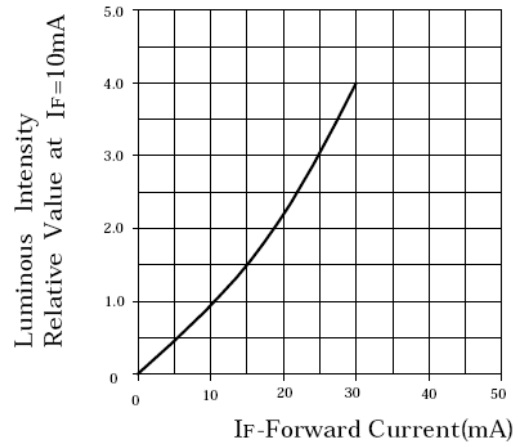

Forward Current vs. Ambient Temperature

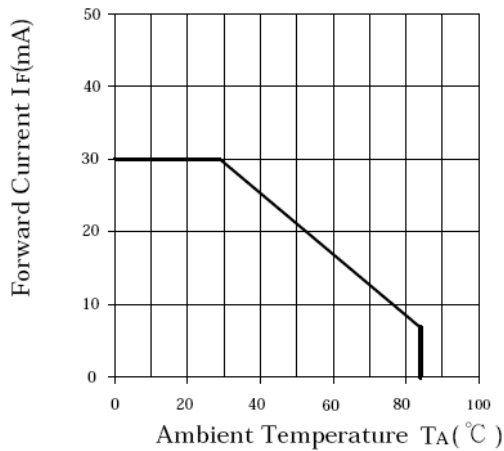

Luminous Intensity vs. Ambient Temperature

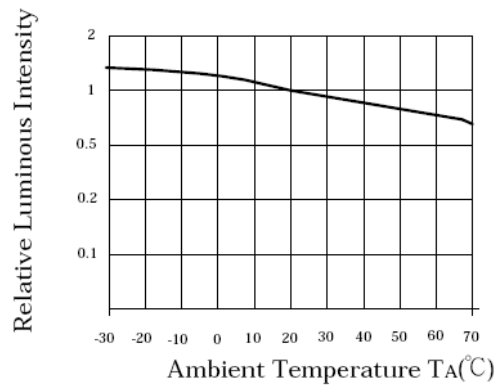

ChromeLED Corp. reserves the right to make changes at any time in order to supply the best product possible. The most current version of this document will always be available at: www.chromeled.com

OPTICAL CHARACTERISTIC CURVES - SUPER RED

Forward Current vs. Forward Voltage

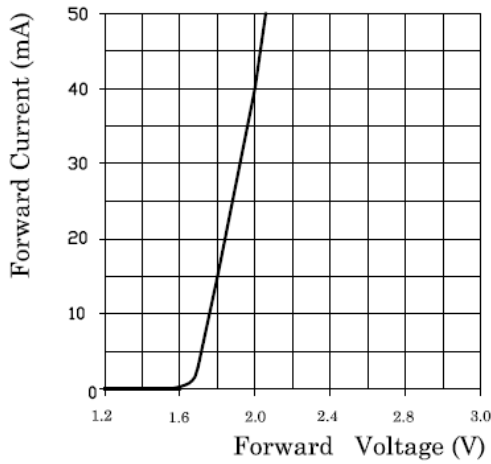

Relative Intensity vs. Forward Current

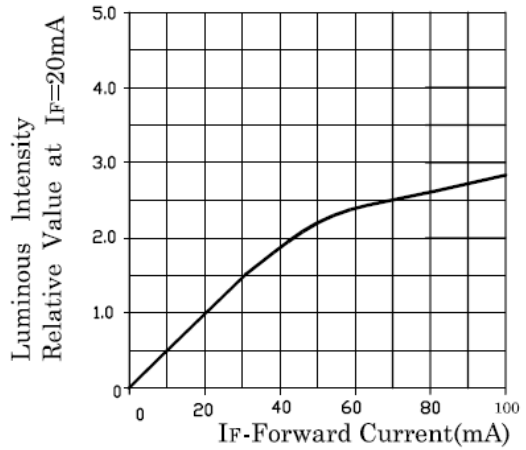

Forward Current vs. Ambient Temperature

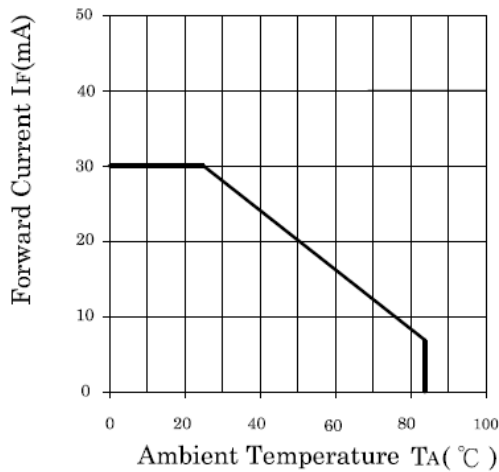

Luminous Intensity vs. Ambient Temperature

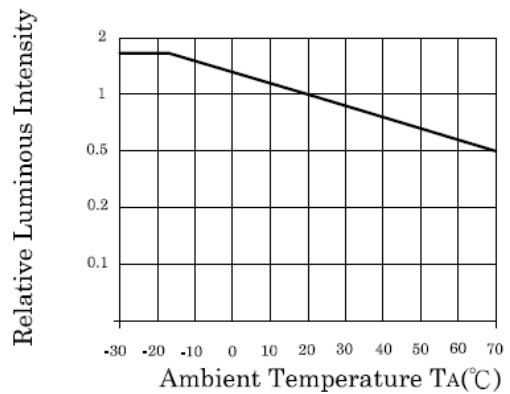

ChromeLED Corp. reserves the right to make changes at any time in order to supply the best product possible. The most current version of this document will always be available at: www.chromeled.com

OPTICAL CHARACTERISTIC CURVES - YELLOW

Forward Current vs. Forward Voltage

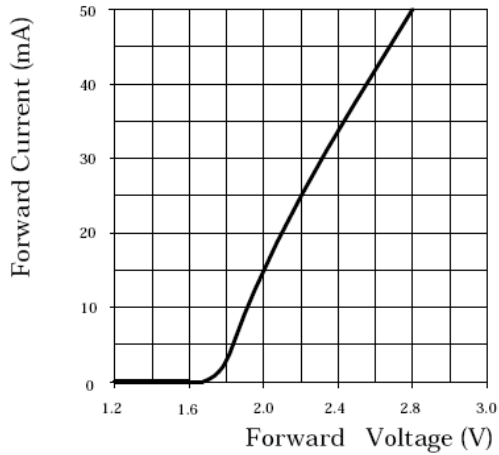

Relative Intensity vs. Forward Current

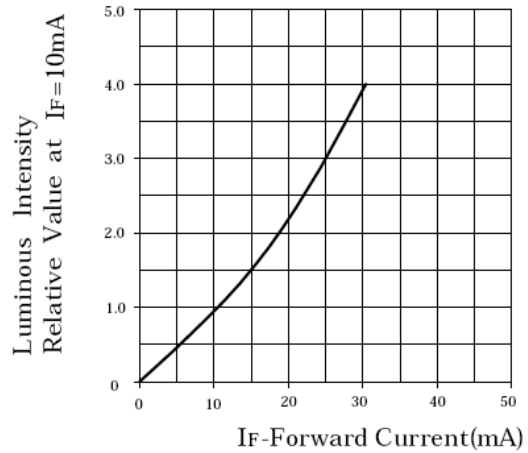

Forward Current vs. Ambient Temperature

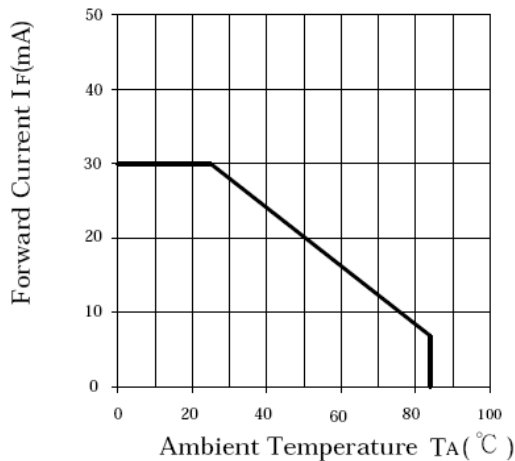

Luminous Intensity vs. Ambient Temperature

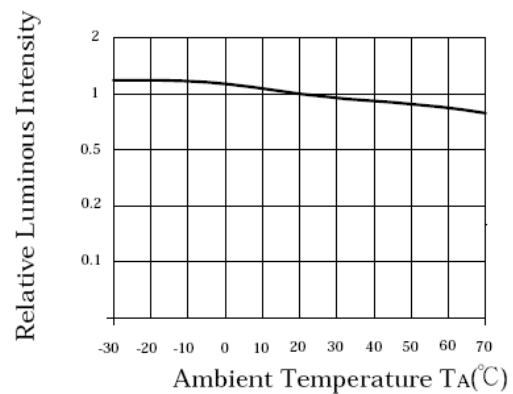

ChromeLED Corp. reserves the right to make changes at any time in order to supply the best product possible. The most current version of this document will always be available at: www.chromeled.com

OPTICAL CHARACTERISTIC CURVES - GREEN

Forward Current vs. Forward Voltage

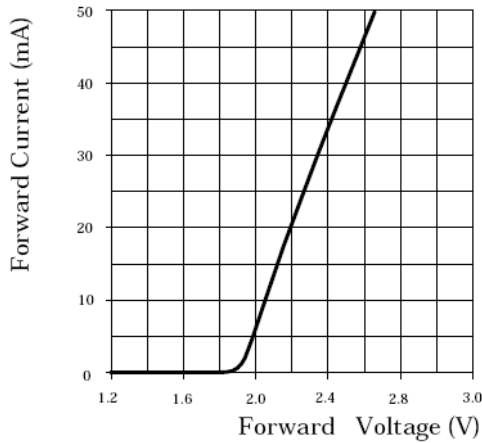

Relative Intensity vs. Forward Current

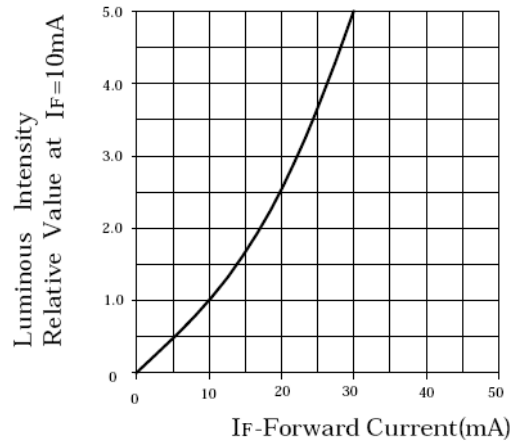

Forward Current vs. Ambient Temperature

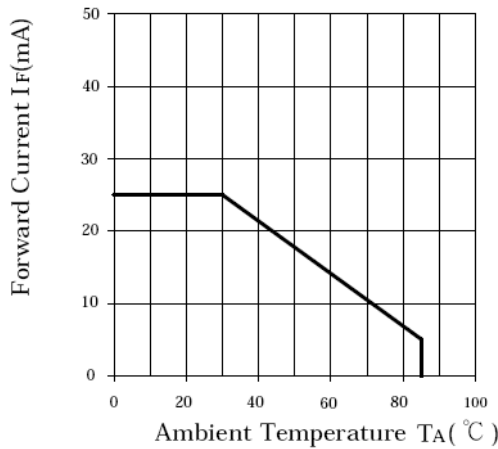

Luminous Intensity vs. Ambient Temperature

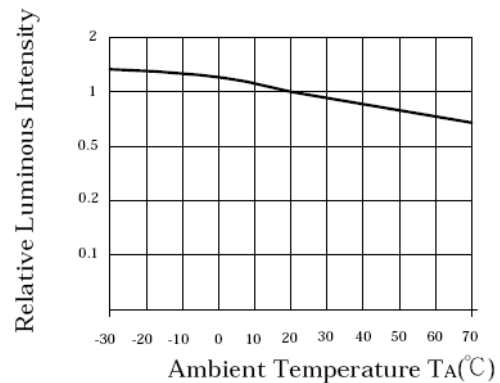

ChromeLED Corp. reserves the right to make changes at any time in order to supply the best product possible. The most current version of this document will always be available at: www.chromeled.com

SOLDERING CONDITIONS - DISPLAY

* Solder the LED no closer than 3mm from the base of the epoxy bulb. Soldering beyond the base of the tie bar is recommended.

* Recommended soldering conditions

Dip Soldering	
Pre-Heat	100 °C Max
Pre-Heat Time	60 Second Max
Solder Bath Temperature	260 °C Max
Dipping Time	5 Second Max
Dipping Position	No lower than 3mm from the base of the epoxy

Hand Soldering		
	3mm Series	Others
Temperature Soldering Time Position	300 °C Max 3 Second Max No closer than 3mm from the base of the epoxy	350 °C Max 3 Second Max No closer than 3mm from the base of the epoxy

* Do not apply any stress to the lead. Particularly when heated.

* The LED must not be repositioned after soldering.

* After soldering the LEDs, the epoxy bulb should be protected from mechanical shock or vibration until the LEDs return to room temperature.

* Direct soldering onto a PC board should be avoided. Mechanical stress to the resin may be caused by the PC board warping or from the clinching and cutting of the leadframes. When it is absolutely necessary, the LEDs may be mounted in this fashion, but, the user will assume responsibility for any problems. Direct soldering should only be done after testing has confirmed that no damage, such as wire bond failure or resin deterioration, will occur. LEDs should not be soldered directly to double sided PC boards because the heat will deteriorate the epoxy resin.

* When it is necessary to clamp the LEDs to prevent soldering failure, it is important to minimize the mechanical stress on the LEDs.

* Cut the LED leadframes at room temperature. Cutting the leadframes at high temperature may cause LED failure.



ChromeLED Corp. reserves the right to make changes at any time in order to supply the best product possible. The most current version of this document will always be available at: www.chromeled.com