

**FEATURES**

- <3% EVM, 145 mA @ P<sub>OUT</sub> = +19 dBm with IEEE 802.11g Modulation at 54 Mbps
- -38 dBc ACPR 1st Sidelobe at +23 dBm with IEEE 802.11b Modulation at 11 Mbps
- -54 dBc ACPR 2nd Sidelobe at +23 dBm with IEEE 802.11b Modulation at 11 Mbps
- No RF Matching Required
- 34 dB of Linear Power Gain
- Temperature-Compensated Linear Power Detector

**APPLICATIONS**

- IEEE 802.11 b/g WLAN
- 2.4 GHz Cordless Phones
- 2.4 GHz ISM Equipment

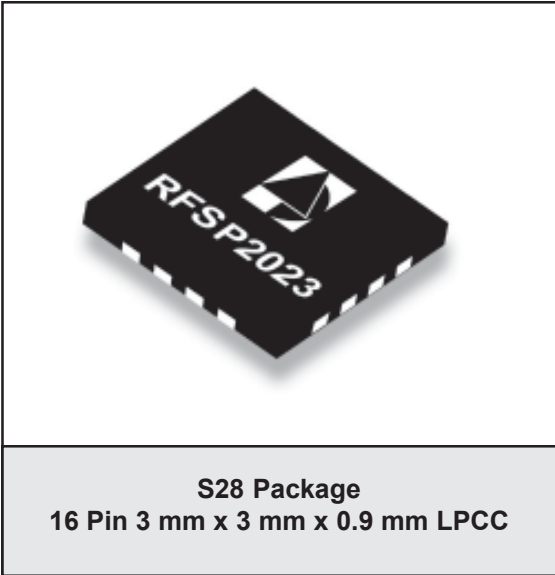

**PRODUCT DESCRIPTION**

The RFS P2023 power amplifier is a high performance InGaP HBT IC designed for transmit applications in the 2.4-2.5 GHz band. The part is matched at the input and output so no additional RF matching components are required off-chip. The

PA exhibits unparalleled linearity and efficiency for both 802.11g and 802.11b WLAN systems. The power detector is temperature compensated on chip enabling a single-ended output voltage. The part is biased by a single +3.3 V supply.

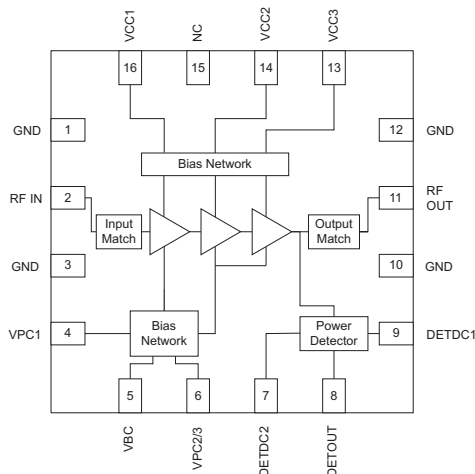

**Figure 1: Block Diagram and Pinout**

Table 1: Pin Description

PIN	NAME	DESCRIPTION	PIN	NAME	DESCRIPTION
1	GND	Ground	9	DET <sub>DC1</sub>	Detector Bias 1
2	RF <sub>IN</sub>	RF Input	10	GND	Ground
3	GND	Ground	11	RF <sub>OUT</sub>	RF Output
4	V <sub>PC1</sub>	Power Control 1	12	GND	Ground
5	V <sub>BC</sub>	Bias Circuit Voltage	13	V <sub>CC3</sub>	Supply Voltage
6	V <sub>PC2/3</sub>	Power Control 2/3	14	V <sub>CC2</sub>	Supply Voltage
7	DET <sub>DC2</sub>	Detector Bias 2	15	NC	No Connect
8	DET <sub>OUT</sub>	Power Detector Output	16	V <sub>CC1</sub>	Supply Voltage

## ELECTRICAL CHARACTERISTICS

Table 2: Absolute Minimum and Maximum Ratings

PARAMETER	MIN	MAX	UNIT	COMMENTS
DC Power Supply ( $V_{CC1}$ , $V_{CC2}$ , $V_{CC3}$ )		4.0	V	
Power Control Level ( $V_{PC1}$ , $V_{PC2/3}$ )		4.0	V	Applied to series resistors external to $V_{PC}$ pins. No RF signal applied.
DC Current Consumption		400	mA	
RF Input Level ( $RF_{IN}$ )		-5	dBm	
Operating Ambient Temperature	0	+85	°C	
Storage Temperature	-55	+150	°C	

Stresses in excess of the absolute ratings may cause permanent damage. Functional operation is not implied under these conditions. Exposure to absolute ratings for extended periods of time may adversely affect reliability.

Table 3: Operating Ranges

PARAMETER	MIN	TYP	MAX	UNIT	COMMENTS
Operating Frequency	2400	-	2500	MHz	
Supply Voltage ( $V_{CC1}$ , $V_{CC2}$ , $V_{CC3}$ )	3.0	3.3	3.6	V	
Power Control Voltage ( $V_{PC1}$ , $V_{PC2/3}$ )	-	3.3	-	V	$PA_{ON}$ . Applied to series resistors external to $V_{PC}$ pins.
	0	-	0.5	V	$PA_{SHUTDOWN}$ . Applied to series resistors external to $V_{PC}$ pins.

The device may be operated safely over these conditions; however, parametric performance is guaranteed only over the conditions defined in the electrical specifications.

**Table 4: IEEE 802.11g Modulation, 54 Mbps OFDM**  
**(V<sub>CC</sub> = 3.3 V, V<sub>PC</sub> = 3.3 V, P<sub>OUT</sub> = +19 dBm, +25 °C)**

PARAMETER	MIN	TYP	MAX	UNIT	COMMENTS
Power Gain	31.5	34.5	37.0	dB	P <sub>OUT</sub> = +19 dBm
Gain Ripple			±0.75	dB	
Current Consumption		145	165	mA	P <sub>OUT</sub> = +19 dBm
Error Vector Magnitude (EVM)		2.8 -31	4.0 -28	% dB	P <sub>OUT</sub> = +19 dBm P <sub>OUT</sub> = +19 dBm
Power Detector Voltage	0.50	0.60	0.70	V	P <sub>OUT</sub> = +19 dBm, 1K $\Omega$ Load
Detector Sensitivity		75		mV/dB	
Detector Output Impedance	1			K $\Omega$	

Notes:

1. EVM includes noise floor of 1% (-40 dB).

**Table 5: IEEE 802.11b Modulation, 11 Mbps DSSS, CCK**  
**(V<sub>CC</sub> = 3.3 V, V<sub>PC</sub> = 3.3 V, P<sub>OUT</sub> = +21 dBm, +25 °C)**

PARAMETER	MIN	TYP	MAX	UNIT	COMMENTS
Power Gain	31.5	34.5	37.0	dB	P <sub>OUT</sub> = +21 dBm
Gain Ripple			±0.75	dB	
Current Consumption		175	195	mA	P <sub>OUT</sub> = +21dBm
ACPR - 1st Sidelobe (11 MHz Offset)		-38	-33	dBc	P <sub>OUT</sub> = +21 dBm; 1,2,5.5,11 Mbps
ACPR - 2nd Sidelobe (22 MHz Offset)		-54	-53	dBc	P <sub>OUT</sub> = +21 dBm; 1,2,5.5,11 Mbps
Power Detector Voltage	0.7	0.8	0.9	V	P <sub>OUT</sub> = +21 dBm, 1K $\Omega$ Load
Detector Sensitivity		75		mV/dB	
Detector Output Impedance	1			K $\Omega$	

**Table 6: Continuous Wave Signal**  
**(V<sub>CC</sub> = 3.3 V, V<sub>PC</sub> = 3.3 V, +25 °C)**

PARAMETER	MIN	TYP	MAX	UNIT	COMMENTS
P1 dB	25.0	26.5	28.0	dBm	
Harmonics 2fo 3fo		-20 -25	-16 -20	dBc	
Stability		5:1			Pout = +25 dBm
Input Return Loss		-7	-4	dB	
Output Return Loss		-12	-9	dB	
Output Noise Power			130	dBm/Hz	
Reverse Isolation	40			dB	
Shutdown Current			1	μA	
Quiescent Current	30	45	60	mA	
T <sub>ON</sub> Setting Time			1	μS	Settles within ±0.5 dB
T <sub>OFF</sub> Setting Time			1	μS	

PERFORMANCE DATA

**Figure 2: Gain, Current, EVM vs. Output Power at 2.412 GHz, 3.3 V (IEEE 802.11g @ 54 Mbps)**

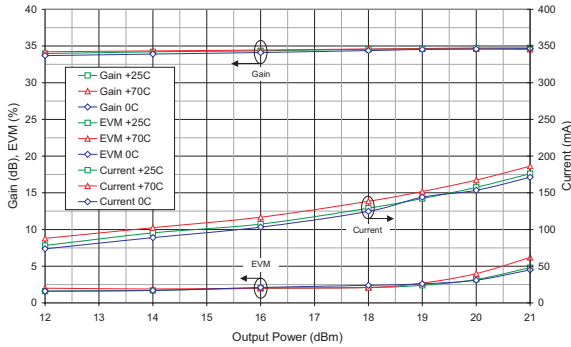

**Figure 3: Gain, Current vs. Output Power at 2.412 GHz, 3.3 V (IEEE 802.11b Signal @ 11 Mbps)**

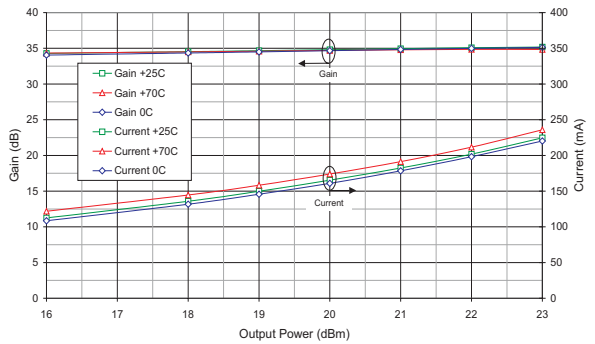

**Figure 4: Gain, Current, EVM vs. Output Power at 2.437 GHz, 3.3 V (IEEE 802.11g @ 54 Mbps)**

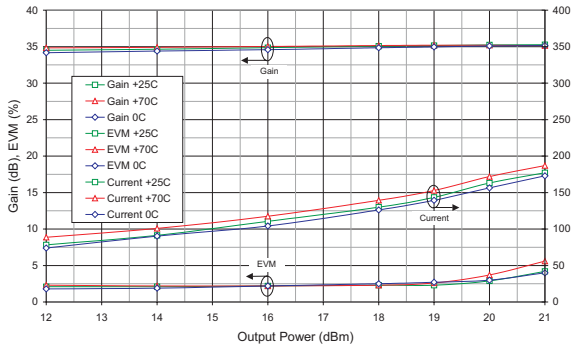

**Figure 5: Gain, Current vs. Output Power at 2.437 GHz, 3.3 V (IEEE 802.11b Signal @ 11 Mbps)**

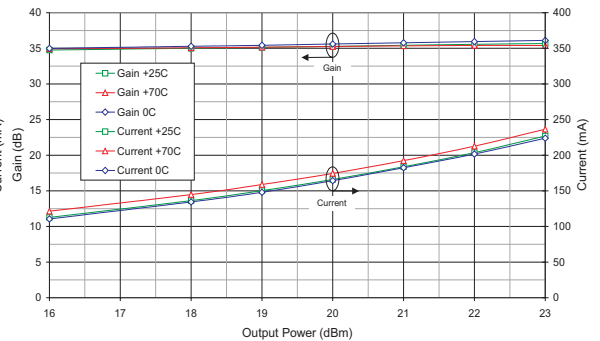

**Figure 6: Gain, Current, EVM vs. Output Power at 2.462 GHz, 3.3 V (IEEE 802.11g @ 54 Mbps)**

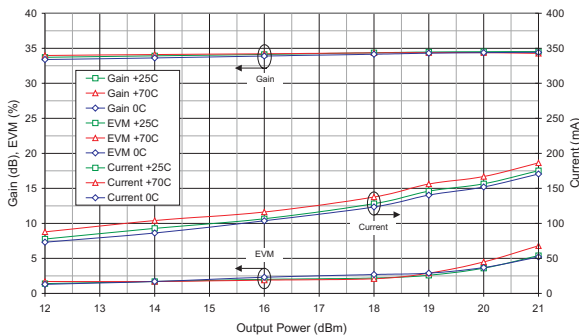

**Figure 7: Gain, Current vs. Output Power at 2.462 GHz, 3.3 V (IEEE 802.11b Signal @ 11 Mbps)**

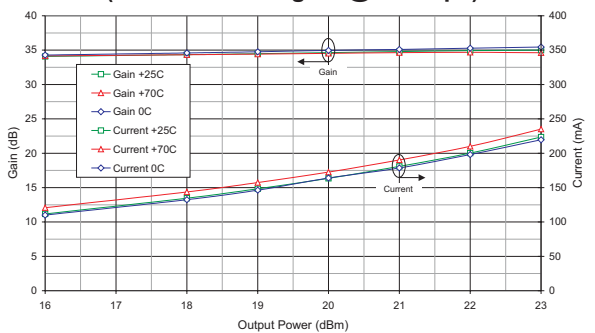

**Figure 8: Power Detector Voltage vs. Output Power at 2.412 GHz, 3.3 V (IEEE 802.11g @ 54 Mbps)**

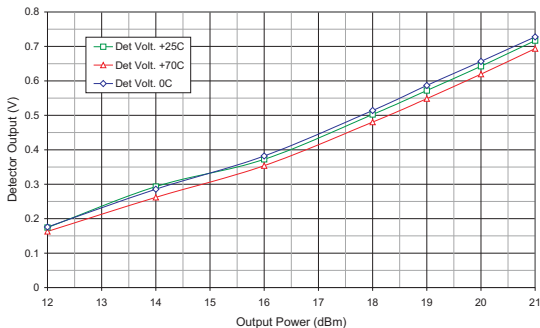

**Figure 9: Power Detector Voltage vs. Output Power at 2.412 GHz, 3.3 V (IEEE 802.11b @ 11 Mbps)**

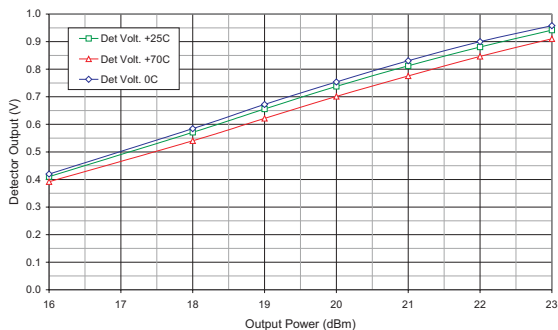

**Figure 10: Power Detector Voltage vs. Output Power at 2.437 GHz, 3.3 V (IEEE 802.11g @ 54 Mbps)**

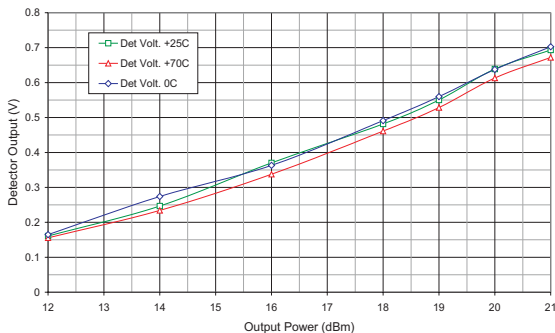

**Figure 11: Power Detector Voltage vs. Output Power at 2.437 GHz, 3.3 V (IEEE 802.11b @ 11 Mbps)**

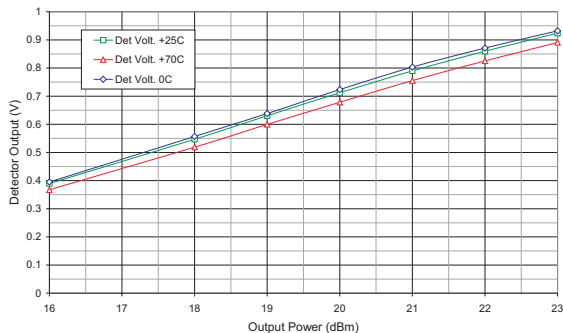

**Figure 12: Power Detector Voltage vs. Output Power at 2.462 GHz, 3.3 V (IEEE 802.11g @ 54 Mbps)**

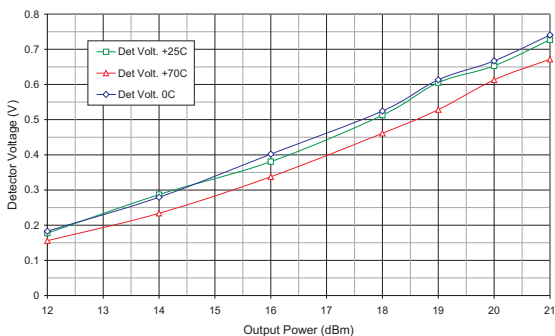

**Figure 13: Power Detector Voltage vs. Output Power at 2.462 GHz, 3.3 V (IEEE 802.11b @ 11 Mbps)**

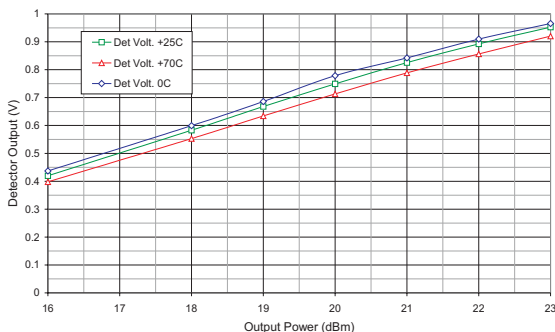

**Figure 14: ACPR Sidelobes vs. Output Power at 2.412 GHz, 3.3 V (IEEE 802.11b @ 11 Mbps)**

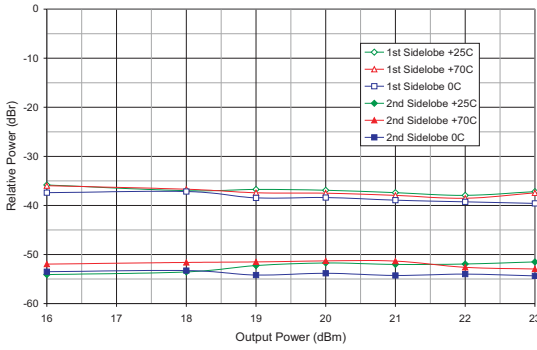

**Figure 15: ACPR Sidelobes vs. Output Power at 2.462 GHz, 3.3 V (IEEE 802.11b @ 11 Mbps)**

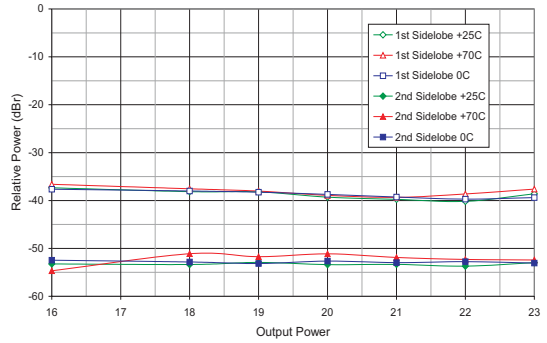

**Figure 16: +23 dBm Output Power at 2.412 GHz, 3.3 V (IEEE 802.11b @ 11 Mbps)**

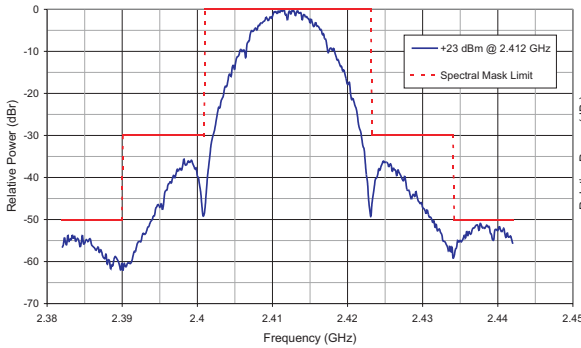

**Figure 17: +23 dBm Output Power at 2.462 GHz, 3.3 V (IEEE 802.11b @ 11 Mbps)**

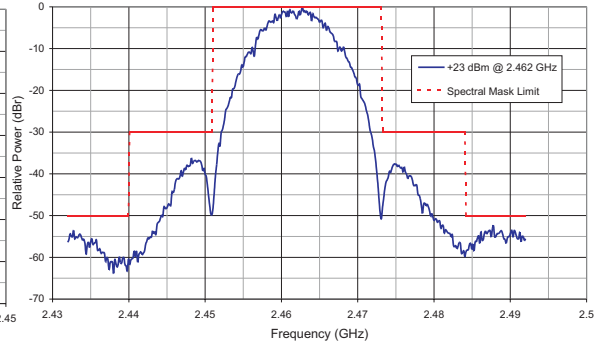

**Figure 18: S-Parameter Data S11 and S22, 3.3 V**

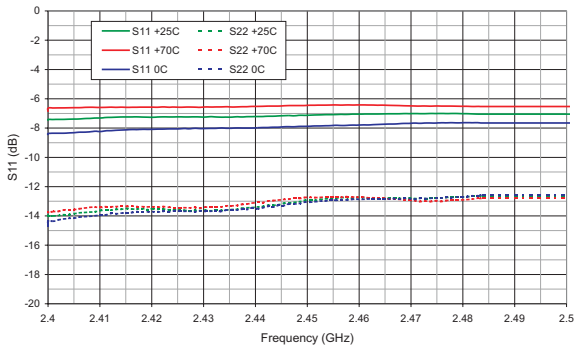



APPLICATION INFORMATION

**\*\*NOTES\*\***

RF traces should be 18 mils wide  
with 20 mils of clearance

DC traces should be 8 mils wide with  
8 mils of clearance

DNP = Do Not Place

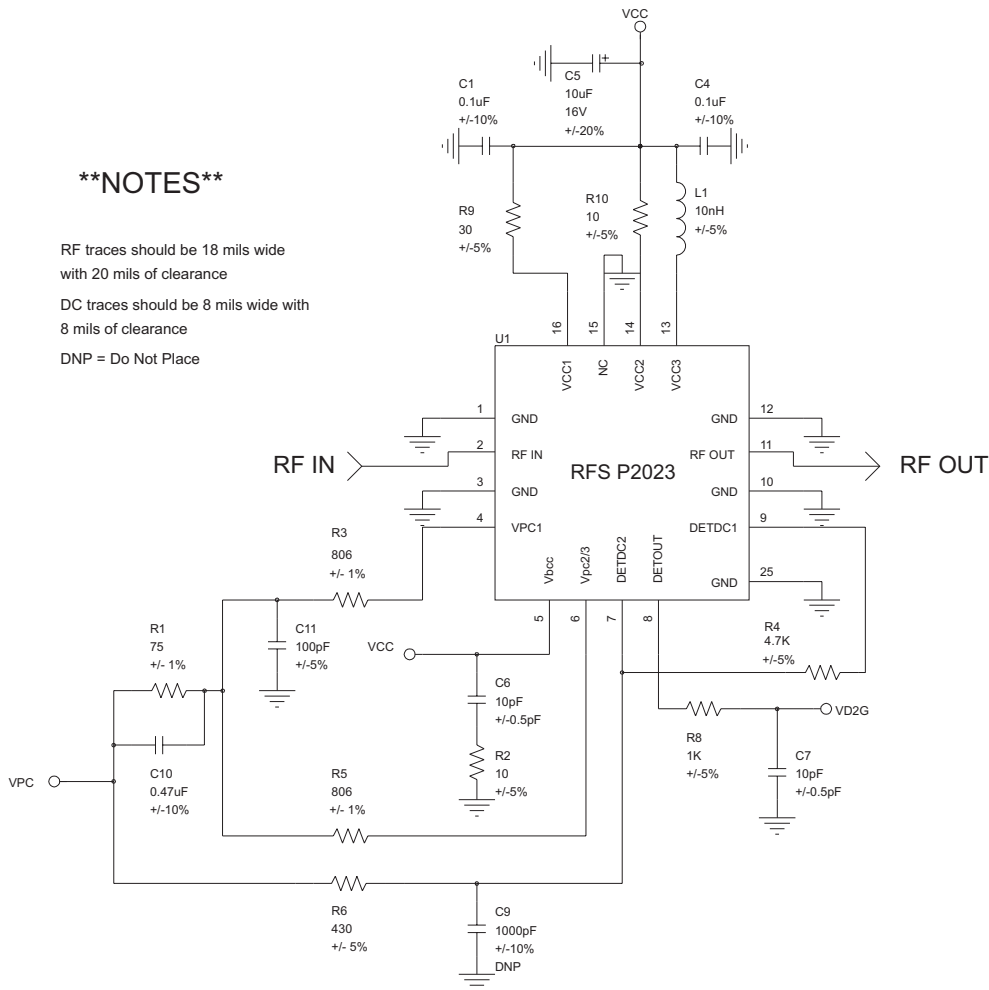
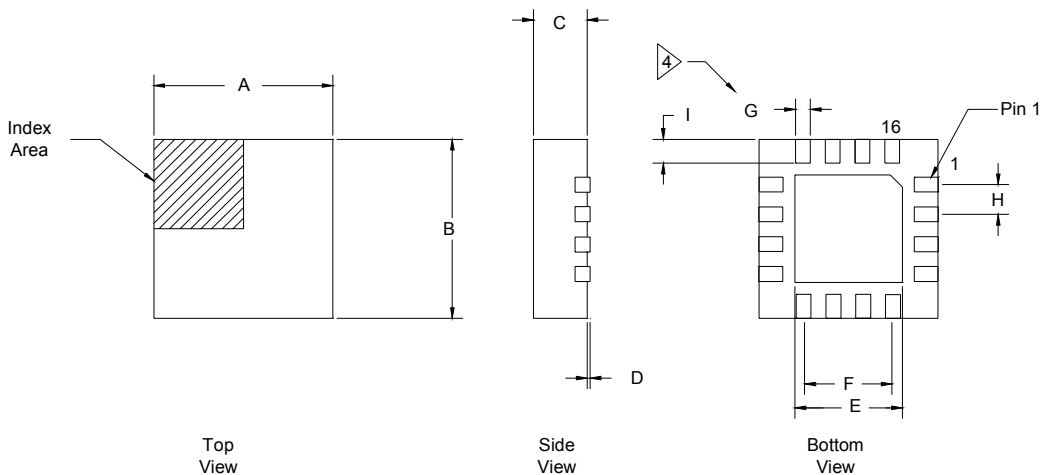

Figure 19: Recommended Application Circuit

PACKAGE OUTLINE



DIMENSION	MILLIMETERS		
	MIN	TYP	MAX
A	2.90	3.00	3.10
B	2.90	3.00	3.10
C	0.80	0.90	1.00
D	0.00	0.02	0.05
E	1.65	1.80	1.95
F	1.50 BSC.		
G	0.225	0.250	0.275
H	0.50 BSC.		
I	0.35	0.40	0.45

1. All dimensions are in millimeters, angles in degrees.
2. The terminal #1 identifier and pad numbering convention shall conform to JESD 95-1 SPP-012
3. Lead coplanarity: 0.05 max.
4. Dimension applies to metalized pad and is measured between 0.25 and 0.30 MM from pad tip.

Figure 20: Package Outline

NOTES

## ORDERING INFORMATION

ORDER NUMBER	TEMPERATURE RANGE	PACKAGE DESCRIPTION	COMPONENT PACKAGING
PRFS-P2023-EVL	0 °C to +70 °C	16 Pin 3 x 3 x 0.9 mm LPCC	1 piece Evaluation Board
PRFS-P2023-005	0 °C to +70 °C	16 Pin 3 x 3 x 0.9 mm LPCC	13" Reverse 2,500 piece Tape and Reel
PRFS-P2023-006	0 °C to +70 °C	16 Pin 3 x 3 x 0.9 mm LPCC	13" Forward 2,500 piece Tape and Reel
PRFS-P2023-007	0 °C to +70 °C	16 Pin 3 x 3 x 0.9 mm LPCC	7" Reverse 1,000 piece Tape and Reel
PRFS-P2023-008	0 °C to +70 °C	16 Pin 3 x 3 x 0.9 mm LPCC	7" Forward 1,000 piece Tape and Reel
PRFS-P2023-009	0 °C to +70 °C	16 Pin 3 x 3 x 0.9 mm LPCC	1-999 piece Tubes or Tray
<b>Leadfree and RoHS Compliant</b>			
RFS2023RS28Q1	0 °C to +70 °C	16 Pin 3 x 3 x 0.9 mm LPCC	1,000 piece Tape and Reel
RFS2023RS28P0	0 °C to +70 °C	16 Pin 3 x 3 x 0.9 mm LPCC	1-999 piece Tubes
RFS2023RS28P6	0 °C to +70 °C	16 Pin 3 x 3 x 0.9 mm LPCC	1-999 piece Tray
EVA2023RS28	0 °C to +70 °C	16 Pin 3 x 3 x 0.9 mm LPCC	1 piece Evaluation Board

**ANADIGICS, Inc.**

141 Mount Bethel Road  
Warren, New Jersey 07059, U.S.A.

Tel: +1 (908) 668-5000

Fax: +1 (908) 668-5132

URL: <http://www.anadigics.com>

E-mail: [Mktg@anadigics.com](mailto:Mktg@anadigics.com)

**IMPORTANT NOTICE**

ANADIGICS, Inc. reserves the right to make changes to its products or to discontinue any product at any time without notice. The product specifications contained in Advanced Product Information sheets and Preliminary Data Sheets are subject to change prior to a product's formal introduction. Information in Data Sheets have been carefully checked and are assumed to be reliable; however, ANADIGICS assumes no responsibilities for inaccuracies. ANADIGICS strongly urges customers to verify that the information they are using is current before placing orders.

**WARNING**

ANADIGICS products are not intended for use in life support appliances, devices or systems. Use of an ANADIGICS product in any such application without written consent is prohibited.