

R-TecBox

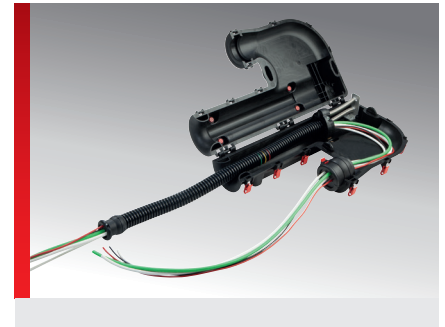

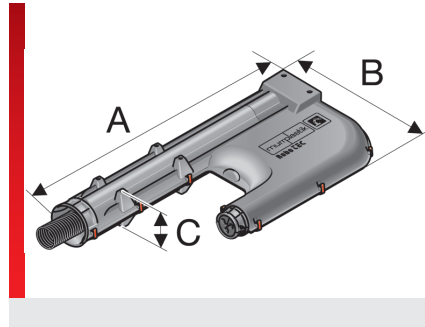





PRODUCT INFORMATION

With their R-TecBox design, Murrplastik has succeeded in creating a new system for optimum management of energy packages from axis 3 to axis 6 of industrial robots. In this specially designed housing with the unique, integrated spring return system, the energy packet is transported safely and

effectively in a low-wear manner within the smallest space.

SPECIFICATIONS

-  Mod. Polypropylene
-  -40 – 140 °C transient / short term
160 °C
-  **HF**
-  RoHS
- 
-  Made in Germany

Type	Order No.	Colour	Suitable for EW-PAE conduit type	Suitable for EWX-PAE conduit type	A mm	B mm	C mm	Stroke mm	Pack qty.
R-Tec Box-S EW 29 MP - 35N	83692693	Black	M32/P29		507.00	285.00	110.00	270.00	1
R-Tec Box-S EWX 29 MP - 35N	83692695	Black		M32/P29	507.00	285.00	110.00	270.00	1
R-Tec Box-S EW 36 MP - 35N	83692696	Black	M40/P36		507.00	285.00	110.00	270.00	1
R-Tec Box-S EWX 36 MP - 35N	83692697	Black		M40/P36	507.00	285.00	110.00	270.00	1
R-Tec Box EW 36 MP - 80N	83692650	Black	M40/P36		730.00	343.00	138.00	400.00	1
R-Tec Box EWX 36 MP - 80N	83692652	Black		M40/P36	730.00	343.00	138.00	400.00	1
R-Tec Box EW 48 MP - 100N	83692654	Black	M50/P48		730.00	343.00	138.00	400.00	1
R-Tec Box EWX 48 MP - 100N	83692656	Black		M50/P48	730.00	343.00	138.00	400.00	1
R-Tec Box EWX 48-KB MP - 100N ¹⁾	83692633	Black		M50/P48	730.00	343.00	138.00	400.00	1
R-Tec Box EW 48 MP - 120N	83692664	Black	M50/P48		730.00	343.00	138.00	400.00	1
R-Tec Box EWX 48 MP - 120N	83692665	Black		M50/P48	730.00	343.00	138.00	400.00	1
R-Tec Box EW/EWX 56 MP - 200N	83692658	Black	56 Jumbo	56 Jumbo	937.50	430.00	176.00	600.00	1
R-Tec Box EW/EWX 70 MP - 200N	83692660	Black	70 Jumbo	70 Jumbo	937.50	430.00	176.00	600.00	1
R-Tec Box EW/EWX 70-KB MP - 200N ¹⁾	83692662	Black	70 Jumbo	70 Jumbo	937.50	430.00	176.00	600.00	1

¹⁾with strain relief V-ZLT-70KB

 Mod. Polypropylene

THERMAL PROPERTIES

 **Temperature / temperature range**
-40 – 140 °C transient / short term 160 °C

TECHNICAL INFORMATION

 **HF** Halogen-free

R-TecBox

CONFORMITY

 **RoHS (EC Directive 2011/65/EU)**

APPROVALS AND OPERATING PERMITS

 **ROBI approval**

 **Made in Germany**

All details given in our sales material prospectuses and catalogues as well as the information available online are based on our current knowledge of the products described.

The electronic data and files made available by Murrplastik, particularly CAD files are based on our current knowledge of the product described.

A legally binding assurance of certain properties or the suitability for a certain purpose can not be determined from this information.

All information with respect to the chemical and physical properties of Murrplastik products as well as application advice given verbally, in writing or by tests, is given to the best of our knowledge.

This does not free the purchaser of carrying out their own inspections and tests in order to determine the suitability of a product for a specific purpose.

Murrplastik accepts no responsibility for the available information being up-to-date, correct or complete. Neither do we accept responsibility for the quality of this information.

Murrplastik accepts no liability for damage caused as a result of using our products.

Murrplastik reserves the right to make technical changes and improvements through constant further development of products and services.

Our General Terms and Conditions apply.