

# NTST20U100CT, NTSB20U100CT-1G, NTSJ20U100CTG, NTSB20U100CTG



ON Semiconductor®

<http://onsemi.com>

## Very Low Forward Voltage Trench-based Schottky Rectifier

Exceptionally Low  $V_F = 0.50\text{ V}$  at  $I_F = 5\text{ A}$

### Features

- Fine Lithography Trench-based Schottky Technology for Very Low Forward Voltage and Low Leakage
- Fast Switching with Exceptional Temperature Stability
- Low Power Loss and Lower Operating Temperature
- Higher Efficiency for Achieving Regulatory Compliance
- Low Thermal Resistance
- High Surge Capability
- Pb-Free and Halide-Free Packages are Available

### Typical Applications

- Switching Power Supplies including Notebook / Netbook Adapters, ATX and Flat Panel Display
- High Frequency and DC-DC Converters
- Freewheeling and OR-ing diodes
- Reverse Battery Protection
- Instrumentation

### Mechanical Characteristics

- Case: Epoxy, Molded
- Epoxy Meets Flammability Rating UL 94-0 @ 0.125 in
- Finish: All External Surfaces Corrosion Resistant and Terminal Leads are Readily Solderable
- Lead Temperature for Soldering Purposes: 260°C Maximum for 10 sec

### PIN CONNECTIONS

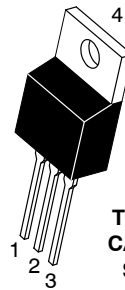
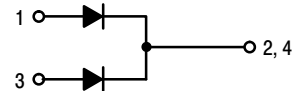

TO-220AB  
CASE 221A  
STYLE 6

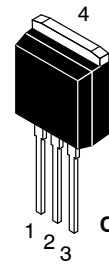

I2PAK  
CASE 418D  
STYLE 3

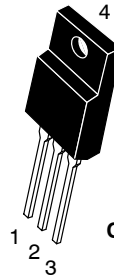

TO-220FP  
CASE 221AH

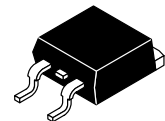

D2PAK  
CASE 418B

### ORDERING INFORMATION

See detailed ordering and shipping information in the package dimensions section on page 5 of this data sheet.

# NTST20U100CT, NTSB20U100CT-1G, NTSJ20U100CTG, NTSB20U100CTG

## MAXIMUM RATINGS

Rating	Symbol	Value	Unit
Peak Repetitive Reverse Voltage Working Peak Reverse Voltage DC Blocking Voltage	$V_{RRM}$ $V_{RWM}$ $V_R$	100	V
Average Rectified Forward Current (Rated $V_R$ , $T_C = 130^\circ\text{C}$ )	$I_{F(AV)}$	Per device 20 Per diode 10	A
Peak Repetitive Forward Current (Rated $V_R$ , Square Wave, 20 kHz, $T_C = 125^\circ\text{C}$ )	$I_{FRM}$	Per device 40 Per diode 20	A
Nonrepetitive Peak Surge Current (Surge applied at rated load conditions halfwave, single phase, 60 Hz)	$I_{FSM}$	150	A
Operating Junction Temperature	$T_J$	-40 to +150	$^\circ\text{C}$
Storage Temperature	$T_{stg}$	-40 to +150	$^\circ\text{C}$
Voltage Rate of Change (Rated $V_R$ )	dv/dt	10,000	V/ $\mu\text{s}$

Stresses exceeding Maximum Ratings may damage the device. Maximum Ratings are stress ratings only. Functional operation above the Recommended Operating Conditions is not implied. Extended exposure to stresses above the Recommended Operating Conditions may affect device reliability.

## THERMAL CHARACTERISTICS

Rating	Symbol	NTST20U100CTG, NTSB20U100CT-1G	NTSB20U100CTG	NTSJ20U100CTG	Unit
Maximum Thermal Resistance per Diode Junction-to-Case Junction-to-Ambient	$R_{\theta JC}$ $R_{\theta JA}$	2.5 70	1.24 46.7	4.20 105	$^\circ\text{C/W}$ $^\circ\text{C/W}$

## ELECTRICAL CHARACTERISTICS (Per Leg unless otherwise noted)

Rating	Symbol	Typ	Max	Unit
Maximum Instantaneous Forward Voltage (Note 1) ( $I_F = 5\text{ A}$ , $T_J = 25^\circ\text{C}$ ) ( $I_F = 10\text{ A}$ , $T_J = 25^\circ\text{C}$ )  ( $I_F = 5\text{ A}$ , $T_J = 125^\circ\text{C}$ ) ( $I_F = 10\text{ A}$ , $T_J = 125^\circ\text{C}$ )	$V_F$	0.55 0.65  0.50 0.58	- 0.79  - 0.68	V
Maximum Instantaneous Reverse Current (Note 1) ( $V_R = 70\text{ V}$ , $T_J = 25^\circ\text{C}$ ) ( $V_R = 70\text{ V}$ , $T_J = 125^\circ\text{C}$ )  (Rated dc Voltage, $T_J = 25^\circ\text{C}$ ) (Rated dc Voltage, $T_J = 125^\circ\text{C}$ )	$I_R$	17 5.3  - 12	- -  800 25	$\mu\text{A}$ mA  $\mu\text{A}$ mA

1. Pulse Test: Pulse Width = 300  $\mu\text{s}$ , Duty Cycle  $\leq 2.0\%$

TYPICAL CHARACTERISTICS

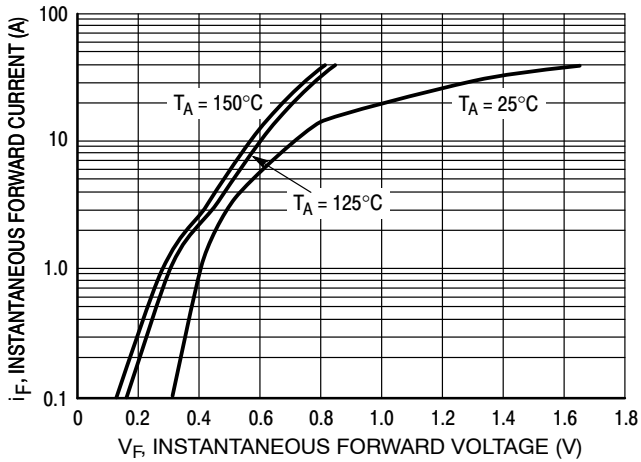

Figure 1. Typical Instantaneous Forward Characteristics

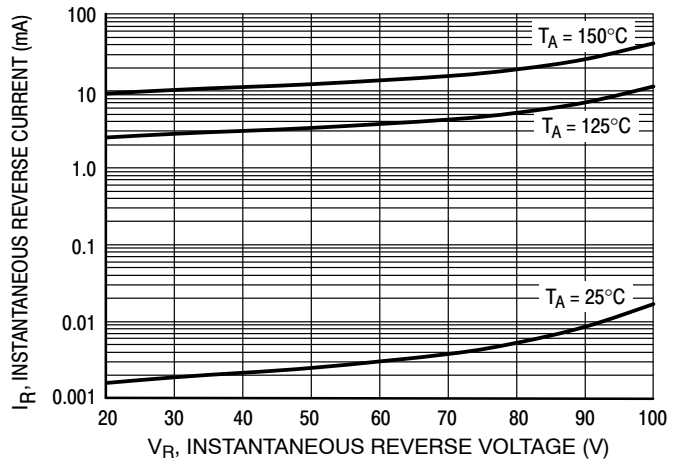

Figure 2. Typical Reverse Characteristics

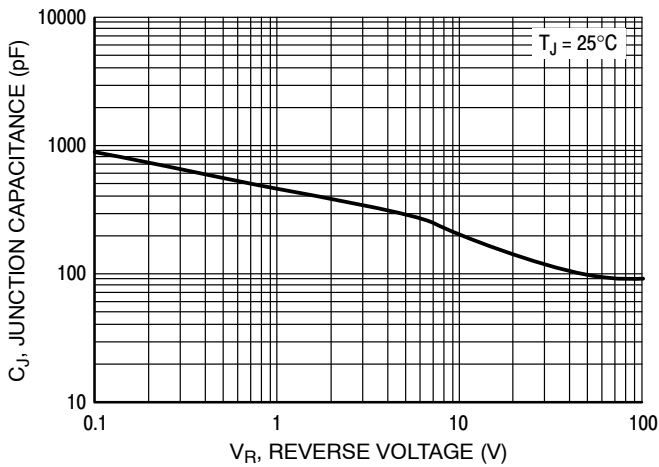

Figure 3. Typical Junction Capacitance

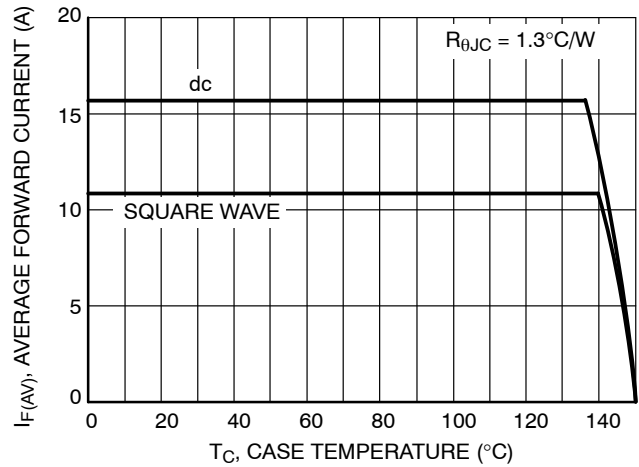

Figure 4. Current Derating per Leg

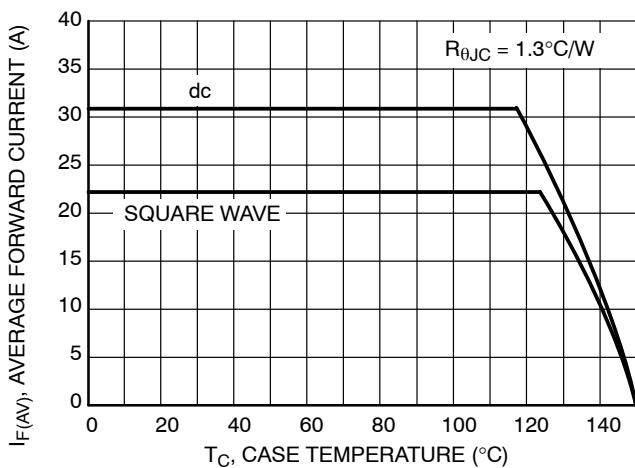

Figure 5. Current Derating

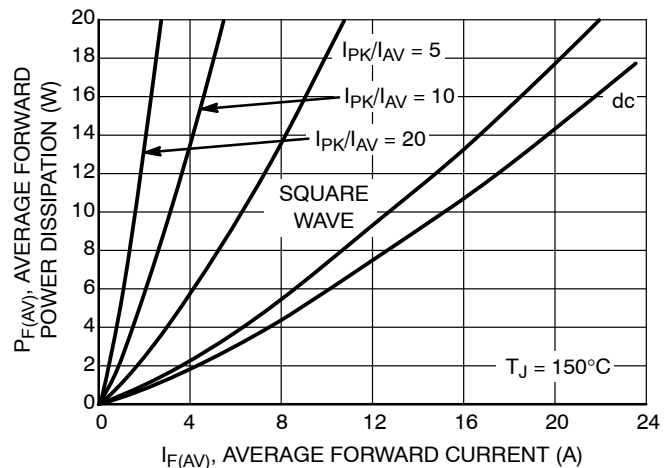

Figure 6. Forward Power Dissipation

TYPICAL CHARACTERISTICS

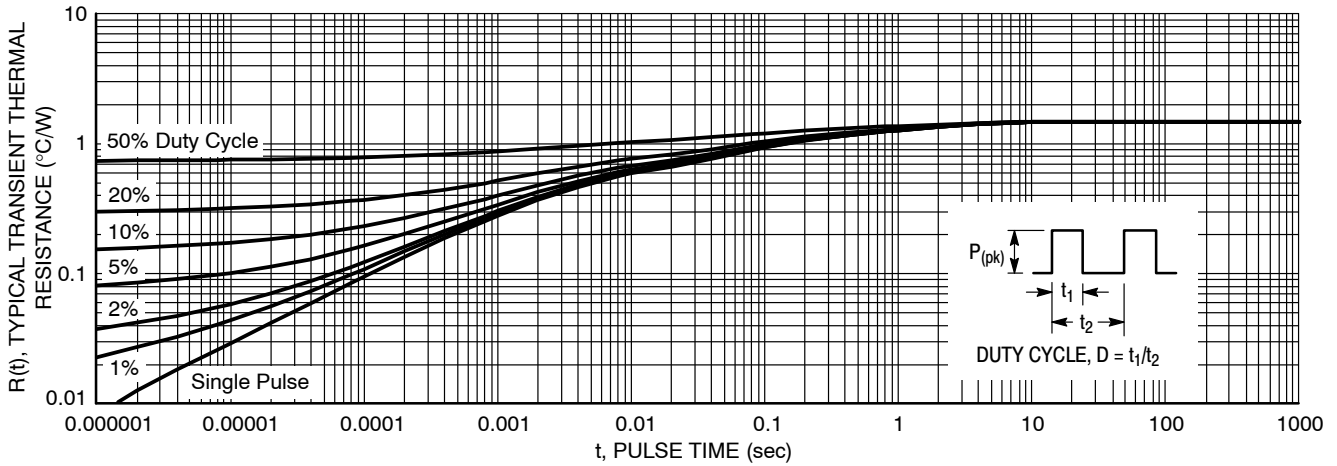

Figure 7. Typical Transient Thermal Response for NTST20U100CT and NTSB20U100CT-1G

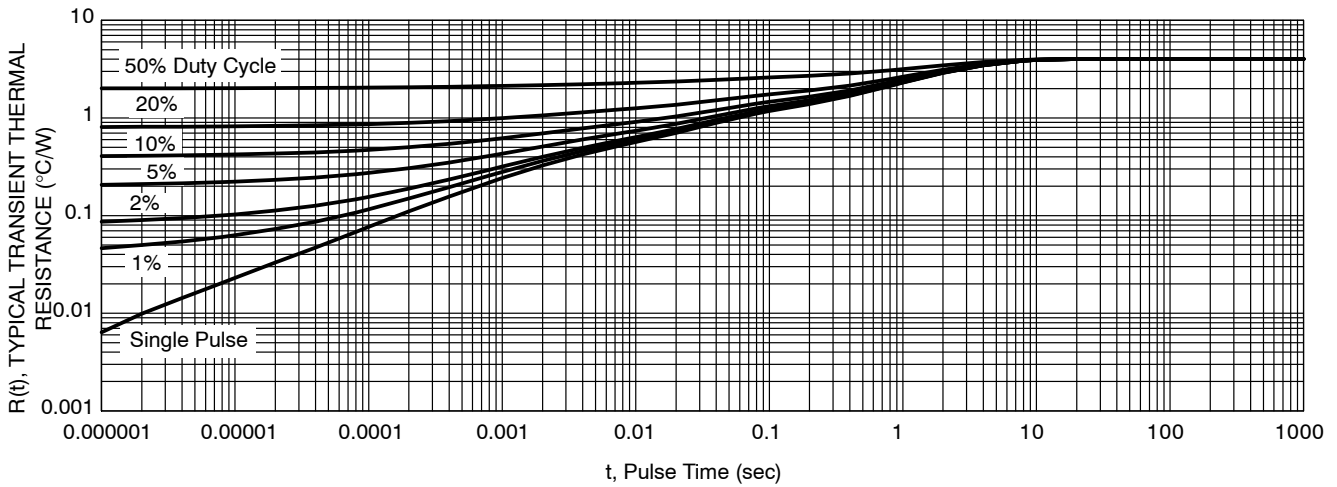

Figure 8. Typical Transient Thermal Response, Junction-to-Case for NTSJ20U100CTG

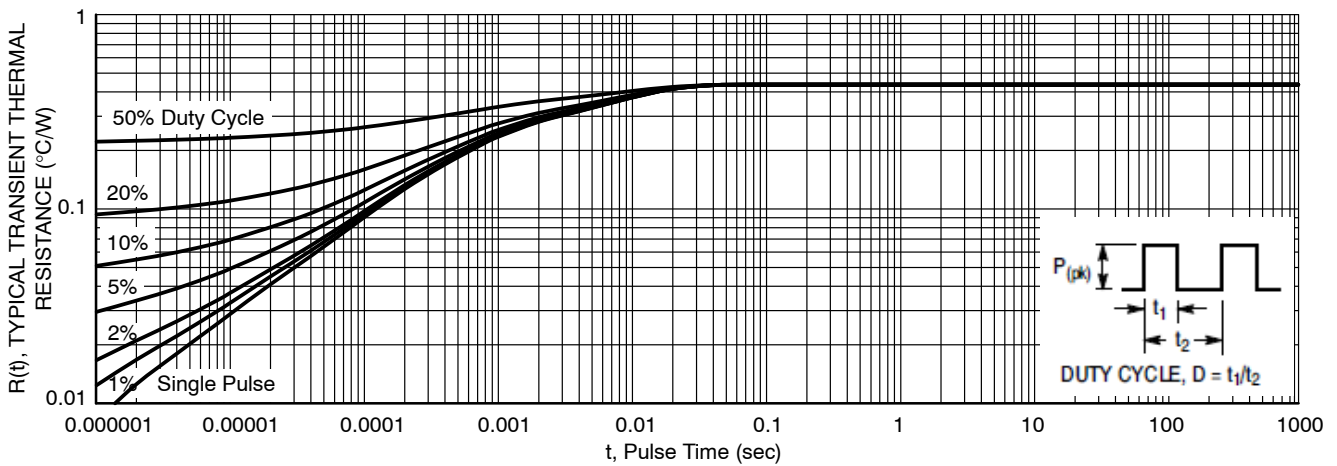

Figure 9. Typical Transient Thermal Response for NTSB20U100CTG

# NTST20U100CT, NTSB20U100CT-1G, NTSJ20U100CTG, NTSB20U100CTG

## ORDERING INFORMATION

Device	Package	Shipping
NTST20U100CTG	TO-220AB (Pb-Free)	50 Units / Rail
NTSB20U100CT-1G	I <sup>2</sup> PAK (Pb-Free)	50 Units / Rail
NTSJ20U100CTG	TO-220FP (Halide-Free)	50 Units / Rail
NTSB20U100CTG	D <sup>2</sup> PAK (Pb-Free)	50 Units / Rail
NTSB20U100CTT4G	D <sup>2</sup> PAK (Pb-Free)	800 / Tape & Reel

## MARKING DIAGRAMS

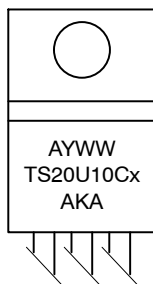

TO-220AB

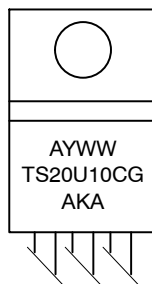

TO-220FP

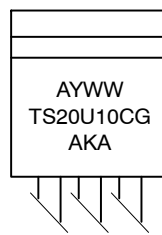

I<sup>2</sup>PAK



D<sup>2</sup>PAK

- A = Assembly Location
- Y = Year
- WW = Work Week
- AKA = Polarity Designator
- x = G or H
- G = Pb-Free Package
- H = Halide-Free Package

NTST20U100CT, NTSB20U100CT-1G, NTSJ20U100CTG, NTSB20U100CTG

PACKAGE DIMENSIONS

TO-220  
CASE 221A-09  
ISSUE AF

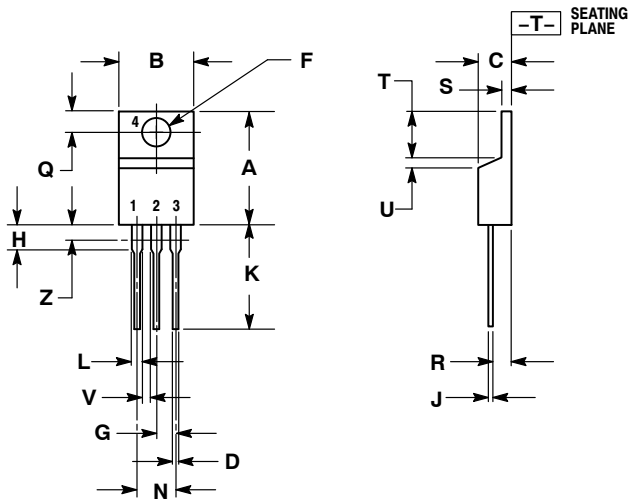

- NOTES:
1. DIMENSIONING AND TOLERANCING PER ANSI Y14.5M, 1982.
  2. CONTROLLING DIMENSION: INCH.
  3. DIMENSION Z DEFINES A ZONE WHERE ALL BODY AND LEAD IRREGULARITIES ARE ALLOWED.

DIM	INCHES		MILLIMETERS	
	MIN	MAX	MIN	MAX
A	0.570	0.620	14.48	15.75
B	0.380	0.405	9.66	10.28
C	0.160	0.190	4.07	4.82
D	0.025	0.035	0.64	0.88
F	0.142	0.161	3.61	4.09
G	0.095	0.105	2.42	2.66
H	0.110	0.155	2.80	3.93
J	0.014	0.025	0.36	0.64
K	0.500	0.562	12.70	14.27
L	0.045	0.060	1.15	1.52
N	0.190	0.210	4.83	5.33
Q	0.100	0.120	2.54	3.04
R	0.080	0.110	2.04	2.79
S	0.045	0.055	1.15	1.39
T	0.235	0.255	5.97	6.47
U	0.000	0.050	0.00	1.27
V	0.045	---	1.15	---
Z	---	0.080	---	2.04

- STYLE 6:
1. ANODE
  2. CATHODE
  3. ANODE
  4. CATHODE

I<sup>2</sup>PAK (TO-262)  
CASE 418D  
ISSUE D

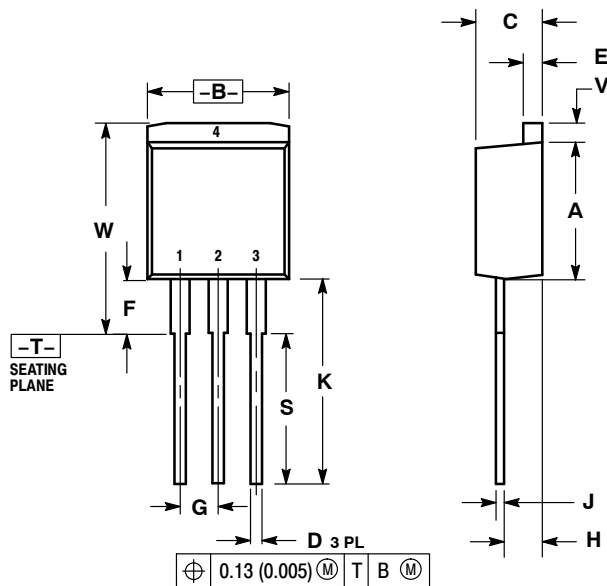

- NOTES:
1. DIMENSIONING AND TOLERANCING PER ANSI Y14.5M, 1982.
  2. CONTROLLING DIMENSION: INCH.

DIM	INCHES		MILLIMETERS	
	MIN	MAX	MIN	MAX
A	0.335	0.380	8.51	9.65
B	0.380	0.406	9.65	10.31
C	0.160	0.185	4.06	4.70
D	0.026	0.035	0.66	0.89
E	0.045	0.055	1.14	1.40
F	0.122 REF		3.10 REF	
G	0.100 BSC		2.54 BSC	
H	0.094	0.110	2.39	2.79
J	0.013	0.025	0.33	0.64
K	0.500	0.562	12.70	14.27
S	0.390 REF		9.90 REF	
V	0.045	0.070	1.14	1.78
W	0.522	0.551	13.25	14.00

PACKAGE DIMENSIONS

TO-220 FULLPACK, 3-LEAD  
CASE 221AH  
ISSUE B

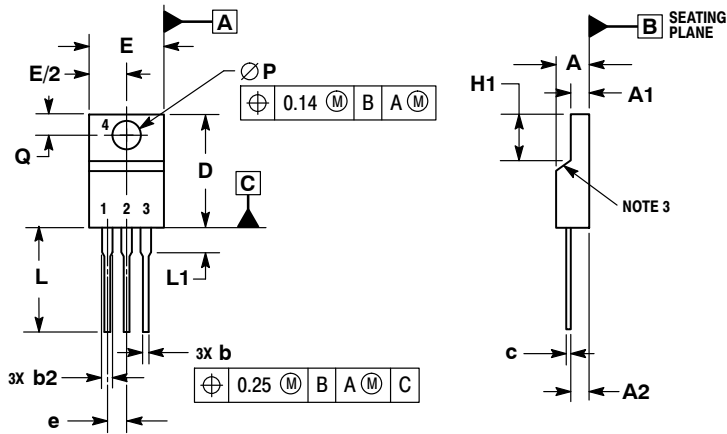

NOTES:

1. DIMENSIONING AND TOLERANCING PER ASME Y14.5M, 1994.
2. CONTROLLING DIMENSION: MILLIMETERS.
3. CONTOUR UNCONTROLLED IN THIS AREA.
4. DIMENSIONS D AND E DO NOT INCLUDE MOLD FLASH AND GATE PROTRUSIONS. MOLD FLASH AND GATE PROTRUSIONS NOT TO EXCEED 0.13 PER SIDE. THESE DIMENSIONS ARE TO BE MEASURED AT OUTERMOST EXTREME OF THE PLASTIC BODY.
5. DIMENSION b2 DOES NOT INCLUDE DAMBAR PROTRUSION. LEAD WIDTH INCLUDING PROTRUSION SHALL NOT EXCEED 2.00.

DIM	MILLIMETERS	
	MIN	MAX
A	4.30	4.70
A1	2.50	2.90
A2	2.50	2.70
b	0.54	0.84
b2	1.10	1.40
c	0.49	0.79
D	14.70	15.30
E	9.70	10.30
e	2.54 BSC	
H1	6.70	7.10
L	12.70	14.73
L1	---	2.80
P	3.00	3.40
Q	2.80	3.20

# NTST20U100CT, NTSB20U100CT-1G, NTSJ20U100CTG, NTSB20U100CTG

## PACKAGE DIMENSIONS

### D<sup>2</sup>PAK 3 CASE 418B-04 ISSUE K

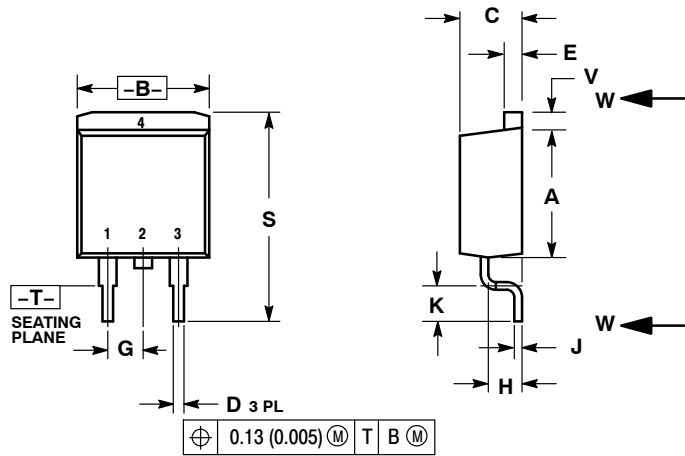

#### NOTES:

1. DIMENSIONING AND TOLERANCING PER ANSI Y14.5M, 1982.
2. CONTROLLING DIMENSION: INCH.
3. 418B-01 THRU 418B-03 OBSOLETE, NEW STANDARD 418B-04.

DIM	INCHES		MILLIMETERS	
	MIN	MAX	MIN	MAX
A	0.340	0.380	8.64	9.65
B	0.380	0.405	9.65	10.29
C	0.160	0.190	4.06	4.83
D	0.020	0.035	0.51	0.89
E	0.045	0.055	1.14	1.40
F	0.310	0.350	7.87	8.89
G	0.100 BSC		2.54 BSC	
H	0.080	0.110	2.03	2.79
J	0.018	0.025	0.46	0.64
K	0.090	0.110	2.29	2.79
L	0.052	0.072	1.32	1.83
M	0.280	0.320	7.11	8.13
N	0.197 REF		5.00 REF	
P	0.079 REF		2.00 REF	
R	0.039 REF		0.99 REF	
S	0.575	0.625	14.60	15.88
V	0.045	0.055	1.14	1.40

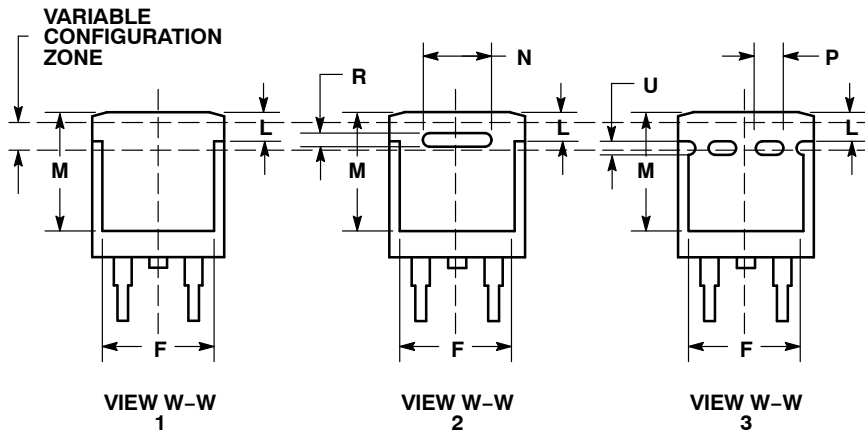

**ON Semiconductor** and **ON** are registered trademarks of Semiconductor Components Industries, LLC (SCILLC). SCILLC owns the rights to a number of patents, trademarks, copyrights, trade secrets, and other intellectual property. A listing of SCILLC's product/patent coverage may be accessed at [www.onsemi.com/site/pdf/Patent-Marking.pdf](http://www.onsemi.com/site/pdf/Patent-Marking.pdf). SCILLC reserves the right to make changes without further notice to any products herein. SCILLC makes no warranty, representation or guarantee regarding the suitability of its products for any particular purpose, nor does SCILLC assume any liability arising out of the application or use of any product or circuit, and specifically disclaims any and all liability, including without limitation special, consequential or incidental damages. "Typical" parameters which may be provided in SCILLC data sheets and/or specifications can and do vary in different applications and actual performance may vary over time. All operating parameters, including "Typicals" must be validated for each customer application by customer's technical experts. SCILLC does not convey any license under its patent rights nor the rights of others. SCILLC products are not designed, intended, or authorized for use as components in systems intended for surgical implant into the body, or other applications intended to support or sustain life, or for any other application in which the failure of the SCILLC product could create a situation where personal injury or death may occur. Should Buyer purchase or use SCILLC products for any such unintended or unauthorized application, Buyer shall indemnify and hold SCILLC and its officers, employees, subsidiaries, affiliates, and distributors harmless against all claims, costs, damages, and expenses, and reasonable attorney fees arising out of, directly or indirectly, any claim of personal injury or death associated with such unintended or unauthorized use, even if such claim alleges that SCILLC was negligent regarding the design or manufacture of the part. SCILLC is an Equal Opportunity/Affirmative Action Employer. This literature is subject to all applicable copyright laws and is not for resale in any manner.

#### PUBLICATION ORDERING INFORMATION

**LITERATURE FULFILLMENT:**  
Literature Distribution Center for ON Semiconductor  
P.O. Box 5163, Denver, Colorado 80217 USA  
**Phone:** 303-675-2175 or 800-344-3860 Toll Free USA/Canada  
**Fax:** 303-675-2176 or 800-344-3867 Toll Free USA/Canada  
**Email:** [orderlit@onsemi.com](mailto:orderlit@onsemi.com)

**N. American Technical Support:** 800-282-9855 Toll Free  
USA/Canada  
**Europe, Middle East and Africa Technical Support:**  
Phone: 421 33 790 2910  
**Japan Customer Focus Center**  
Phone: 81-3-5817-1050

**ON Semiconductor Website:** [www.onsemi.com](http://www.onsemi.com)  
**Order Literature:** <http://www.onsemi.com/orderlit>

For additional information, please contact your local Sales Representative