

order number	lens name
0701-399-000-40	Rodagon-WA 4/40

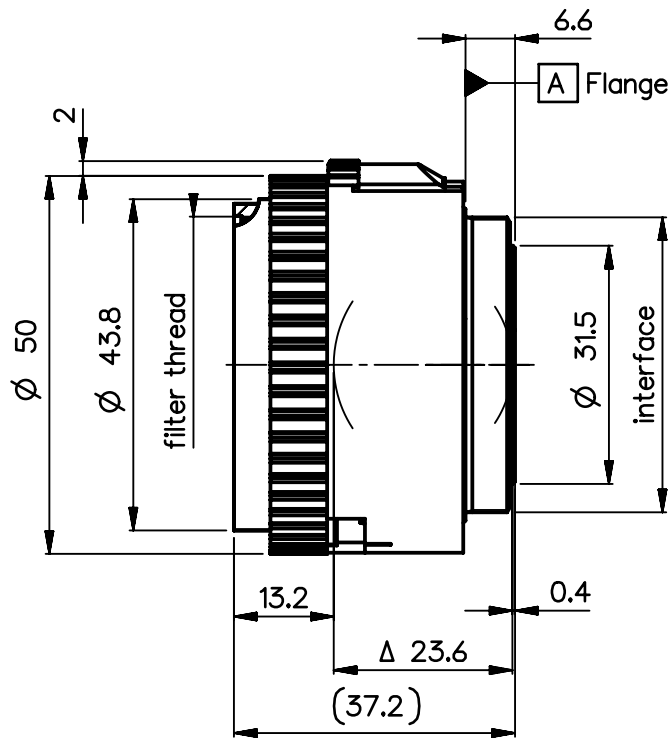

Specification		ON	7411-9001
image circle max. (mm)	46	working distance (mm)	175 - 625
focal length f' (mm) *	40.4	interface	M39 x1/26" (Leica)
magnification β' [range]	-0.1 [-0.25 ... -0.066]	filter thread	M40.5 x0.5
spectral range λ (nm)	400 - 750	weight (g)	85

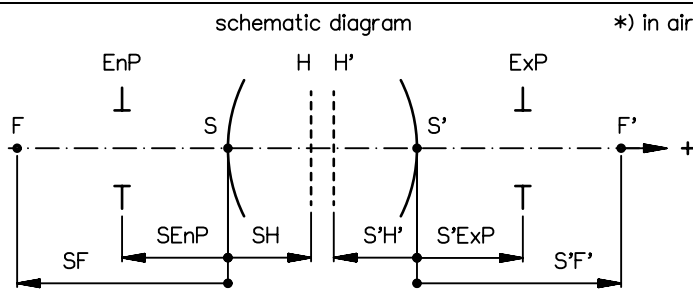

design includes CCD cover glass:		no		
SF (mm)	-26.5	f-stop	Ø EnP	Ø Exp
S'F' (mm) *	31.2	4	5.0	10.7
HH' (mm) *	0.5	5.6	7.2	7.7
SH (mm)	13.9	8	5.0	5.4
S'H' (mm) *	-9.2	11	3.6	3.9
SEnP (mm)	11.1	16	2.5	2.7
S'Exp (mm) *	-12.2	22	1.8	2.0

PROTECTIVE NOTE "DIN ISO 16016" TO BE OBSERVED	EU-D	AL-T1A	US-D	US-ML	not export controlled
	REV	ECC	DATE	APPROVED	PDM Status Freigabe
	a	Neuausg			-
	b	12-0013	22.02.12	Kuehne	
	c	12-0185	25.04.12	Schuber	SCALE 1:1
	d	14-0184	07.08.14	Schiffle	MATERIAL
					TITLE
					Rodagon-WA 4/40
					FIRST DATE NAME
					ISSUE 04.04.08 Auer
					CHKD 01.08.08 Schaeffler
					DRAWING NO.
					0701-399-100-00-0001d
					SHEET 1
					OF 1
					REPLACES

ALL DIMENSIONS ARE IN MM AND INCLUDE SURFACE TREATMENT

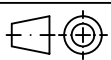

Rodagon-WA_4/40

MTF at ratio -0.1 f/ 4.0

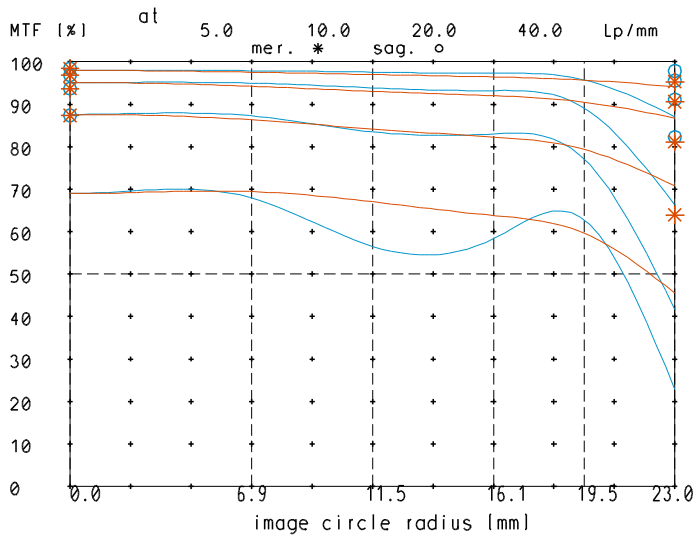

relative light fall-off at ratio -0.1

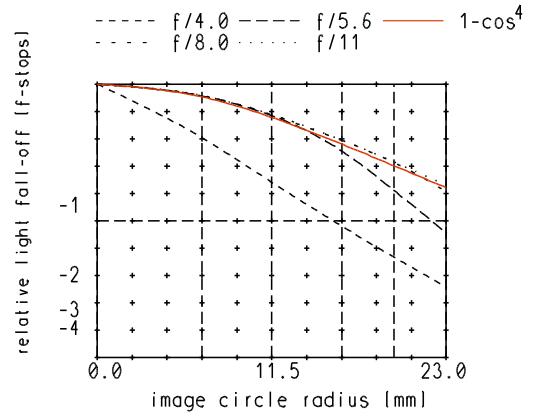

MTF at ratio -0.1 f/ 8.0

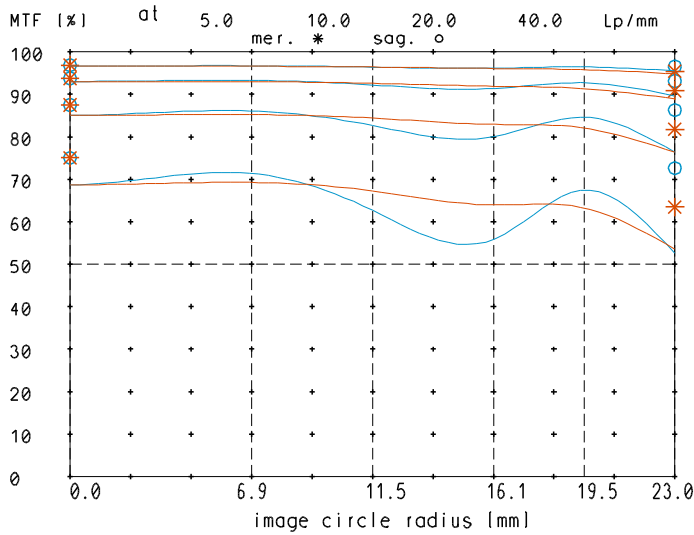

Distortion at ratio 0.05x to 0.5x

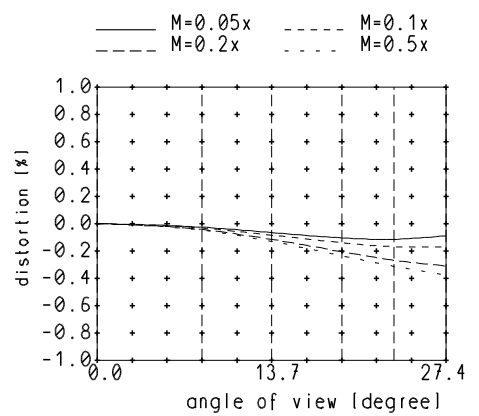

— sagittal. o Diffraction limited value
— meridional * Diffraction limited value

Longitudinal color aberration at ratio -0.1

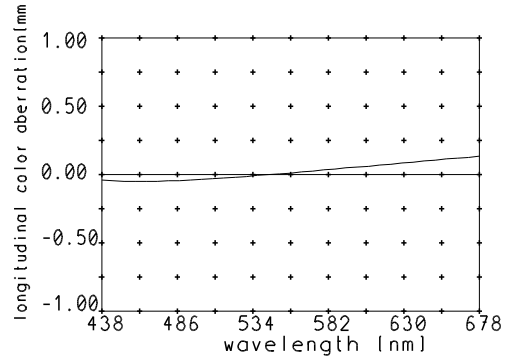

Named frequencies (line pairs/mm) in modular transfer function (MTF) as well as diagrams of relative light fall-off, distortion and longitudinal color aberration refer to film plane.