

ANNA-B412

Stand-alone Bluetooth 5.1 low energy module

Data sheet

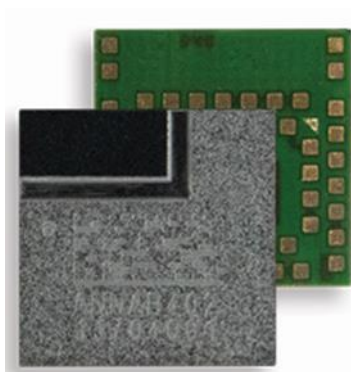

Abstract

Targeted towards system integrators and design engineers, this technical data sheet includes the functional description, pin definition, specifications, country approval status, handling instructions, and ordering information for the ultra-compact ANNA-B412 stand-alone Bluetooth® 5.1 Low Energy module. Despite its small size, ANNA-B4 offers both internal and external antenna options: whereas ANNA-B402 [5] provides an open CPU architecture with a powerful MCU for customer applications, ANNA-B412 [6] is delivered with pre-flashed u-connectXpress software that supports OEMs with the shortest time-to-market. ANNA-B41212 supports u-blox Bluetooth Low Energy Serial Port Service, GATT client and server, beacons, Bluetooth long range, NFC™, and simultaneous peripheral and central roles.

Document information

Title	ANNA-B412	
Subtitle	Stand-alone Bluetooth 5.1 low energy module	
Document type	Data sheet	
Document number	UBX-21028698	
Revision and date	R05	20-Jan-2023
Disclosure Restriction	C1-Public	

Product status	Corresponding content status	
Functional sample	Draft	For functional testing. Revised and supplementary data will be published later.
In development / Prototype	Objective specification	Target values. Revised and supplementary data will be published later.
Engineering sample	Advance information	Data based on early testing. Revised and supplementary data will be published later.
Initial production	Early production information	Data from product verification. Revised and supplementary data may be published later.
Mass production / End of life	Production information	Document contains the final product specification.

This document applies to the following products:

Product name	Type number	Software	Hardware version	PCN reference	Product status
ANNA-B412	ANNA-B412-00B-00	u-connectXpress 1.0	03	N/A	Initial production

u-blox or third parties may hold intellectual property rights in the products, names, logos, and designs included in this document. Copying, reproduction, or modification of this document or any part thereof is only permitted with the express written permission of u-blox. Disclosure to third parties is permitted for clearly public documents only.

The information contained herein is provided "as is" and u-blox assumes no liability for its use. No warranty, either express or implied, is given, including but not limited to, with respect to the accuracy, correctness, reliability, and fitness for a particular purpose of the information. This document may be revised by u-blox at any time without notice. For the most recent documents, visit www.u-blox.com.

Copyright © u-blox AG

Contents

Document information	2
Contents	3
1 Functional description	5
1.1 Overview	5
1.2 Example applications	5
1.3 Block diagram	6
1.4 Product description	7
1.5 Software architecture.....	7
1.6 u-connectXpress.....	8
1.7 Bluetooth device address.....	8
2 Interfaces	9
2.1 Power management.....	9
2.1.1 Module supply input (VCC)	9
2.2 RF antenna interfaces	9
2.2.1 2.4 GHz radio and internal antenna	9
2.2.2 Near Field Communication (NFC)	9
2.2.3 Direction Finding (AoA/AoD)	10
2.3 System functions	10
2.3.1 Module power ON.....	10
2.3.2 Power modes	10
2.3.3 Module power OFF.....	11
2.3.4 Module reset	11
2.4 Low frequency clock	11
2.5 System interfaces	12
2.5.1 GPIO	12
2.5.2 UART	12
2.5.3 u-blox Serial Port Service (SPS).....	13
2.5.4 System status signals	13
2.5.5 System control signals	13
3 Pin definition.....	14
3.1 ANNA-B412 pin assignment.....	14
4 Electrical specifications	17
4.1 Absolute maximum ratings.....	17
4.1.1 Maximum ESD ratings.....	17
4.2 Operating conditions.....	17
4.2.1 Operating temperature range.....	17
4.2.2 Supply/Power pins	18
4.2.3 Current consumption	18
4.2.4 RF performance.....	19
4.2.5 Startup times.....	19

4.2.6	Flash memory	19
4.2.7	LFXO crystal specifications.....	19
4.2.8	ANNA-B412 radiation patterns.....	20
4.2.9	RESET_N pin	21
4.2.10	Digital pins.....	22
5	Mechanical specifications.....	23
6	Qualification and approvals	26
6.1	Country approvals	26
6.2	Bluetooth qualification	26
7	Product handling.....	27
7.1	Packaging	27
7.2	Reels	27
7.3	Tapes.....	27
7.4	Moisture sensitivity levels	28
7.5	Reflow soldering.....	28
7.6	ESD precautions	29
8	Labelling and ordering information	30
8.1	Product marking	30
8.2	Product identifiers	30
8.3	Identification codes	31
8.4	Ordering information.....	31
Appendix	32
A	Glossary.....	32
Related documents	33
Revision history	33
Contact.....	34

1 Functional description

1.1 Overview

ANNA-B412 is an ultra-compact, stand-alone Bluetooth® 5.1 Low Energy module packed into a System-in-Package (SiP) design with pre-flashed u-connectXpress software.

Based on the Nordic Semiconductor nRF52833 chip that includes an integrated 2.4 GHz transceiver with +8 dBm output power and powerful Arm® Cortex®-M4 with FPU processor, ANNA-B412 stand-alone modules support all Bluetooth 5.1 low energy modes, including long range mode.

Delivered with pre-flashed u-connectXpress software, ANNA-B412 provides support for u-blox Bluetooth Low Energy Serial Port Service, GATT client and server, Bluetooth beacons, Bluetooth long range, NFC™, and simultaneous peripheral and central roles.

Despite the small size, ANNA-B412 offers both internal and external antenna options. With the internal chip antenna option, ANNA-B412 can ease the integration of end-product. With the ANNA-B412 external antenna option, external antennas can be connected to an ANNA-B412 module through the antenna pin of the module.

Featuring Angle of Arrival (AoA) and Angle of Departure (AoD) transceivers, ANNA-B412 supports the Bluetooth 5.1 Direction Finding service. The service can be used for indoor positioning, wayfinding, asset tracking, and more. With ANNA-B412 external antenna option, the Bluetooth 5.1 Direction Finding service may also be supported using u-connectLocate software. Currently, u-connectLocate software is only available for [NINA-B41 series](#) modules. [Contact](#) your local support team for information concerning the availability of ANNA-B412 u-connectLocate software.

ANNA-B412 needs only a single supply voltage in the range of 1.7–3.6 V and can be easily integrated into simple, single-voltage, rail systems. The broad supply voltage range low power consumption of ANNA-B412 makes it particularly useful in battery powered systems.

With an operational temperature range that spans from -40 up to +105°C, ANNA-B412 is particularly suited for harsh applications that must operate at high ambient temperatures.

With the same physical size and mechanical design of ANNA-B112 module, ANNA-B412 offers a natural upgrade path for existing ANNA-B112 applications. Four additional pins on the ANNA-B412 module, included to increase the number of supported GPIOs, can be conveniently accommodated within a common module footprint. ANNA-B412 also extends the operating temperature range to +105 degrees, beyond the +85 degrees from ANNA-B112. See also the ANNA-B112 data sheet [\[7\]](#) and ANNA-B412 product summary[\[6\]](#).

1.2 Example applications

- Industrial automation
- Smart buildings and cities
- Low power sensors
- Wireless-connected and configurable equipment
- Point-of-sales
- Health devices
- Asset tracking
- Wearables

1.3 Block diagram

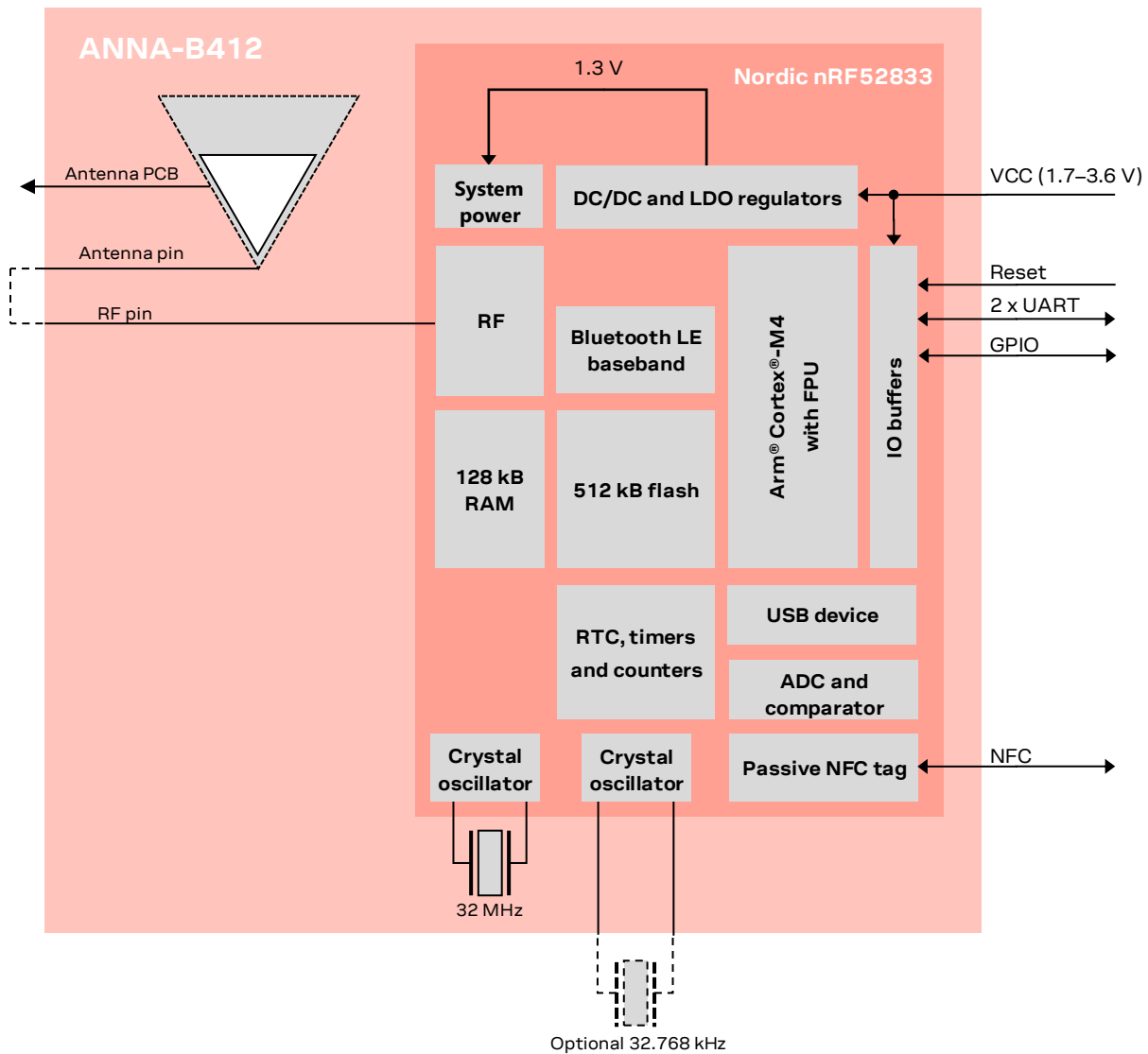

Figure 1: Block diagram of ANNA-B412

The ANNA-B412 SiP module includes an integrated antenna. The RF signal pin can either be connected directly to the adjacent antenna pin for use with the internal antenna or routed to an external antenna or antenna connector. See also [2.4 GHz radio and internal antenna](#).

The module does not have its own low power oscillator (LPO) and, depending on the power consumption requirement, end users could connect an external LPO crystal or oscillator. See also [Low frequency clock](#).

An integrated DC/DC converter is used for higher efficiency under heavy load situations. See also [Module supply input \(VCC\)](#).

1.4 Product description

Item	ANNA-B412
Chip inside	Nordic Semiconductor nRF52833
Bluetooth version	5.1
Band support	2.4 GHz, 40 channels
Typical conducted output power	+8 dBm
Maximum radiated output power with internal antenna (EIRP)	+9 dBm
Maximum radiated output power with external antenna (EIRP)	+13 dBm
RX sensitivity, 1 Mbps (conducted)	-94 dBm
RX sensitivity, 125 kbps (conducted)	-103 dBm
Supported 2.4 GHz radio modes	Bluetooth Low Energy
Supported Bluetooth Low Energy (LE) data rates	1 Mbps 2 Mbps 125 kbps (Coded PHY, S=8)
Physical module size	6.5 x 6.5 x 1.2 mm

Table 1: ANNA-B412 characteristics summary

1.5 Software architecture

ANNA-B412 modules are integrated with an Arm® Cortex®-M4 application processor with FPU, 512 kB flash memory, and 128 kB RAM. ANNA-B412 modules are also delivered with pre-installed module software, including:

- Pre-flashed secure bootloader and u-connectXpress software that interfaces through an AT command interpreter to control customer application software running on host MCUs.
- The Nordic S140 SoftDevice Low Energy protocol stack that supports the Bluetooth Low Energy Serial Port Service, GATT server and client, central and peripheral roles, and multidrop connections.

Figure 2 shows the architecture and implementation of software components in ANNA-B412.



Figure 2: ANNA-B412 software structure

1.6 u-connectXpress

ANNA-B412 modules are pre-flashed with u-connectXpress software and delivered with the u-blox secure bootloader.

Controlled by AT commands over the UART interface, the u-connectXpress software enables use of the Bluetooth Low Energy (LE) functions. Supported features of the software include the u-blox low energy Serial Port Service, GATT server and client, central and peripheral roles, and multi-drop connections. ANNA-B412 modules can be configured by AT commands, or by using the s-center evaluation software [8], which can be downloaded from the [u-blox](#) website and is available free of charge.

To learn more about the features of the u-connectXpress software and the AT commands, see also the u-connectXpress software user guide [4] and u-connectXpress AT commands manual [2].

1.7 Bluetooth device address

Each ANNA-B412 module is pre-programmed with a unique, 48-bit, Bluetooth device address.

2 Interfaces

2.1 Power management

2.1.1 Module supply input (VCC)

ANNA-B412 modules use integrated step-down converters to transform the supply voltage presented at the **VCC** pin into a stable system voltage. Consequently, the modules are compatible for use in battery powered designs – without the need of an additional voltage converter.

ANNA-B412 supports two on-board converters:

- Low-dropout (LDO)
- DC/DC buck

ANNA-B412 modules automatically switch between these converters to suit the prevailing current consumption. The DC/DC converter is more efficient under high loads when the radio is active, while the LDO converter is better suited for power saving modes.

 ANNA-B412 modules only support normal voltage mode as the supply voltage pins **VDD** and **VDDH** on nRF52833 are shorted together inside the modules. See the Nordic Semiconductor specification for more information about the [supply voltage mode of nRF52833](#).

2.2 RF antenna interfaces

2.2.1 2.4 GHz radio and internal antenna

The RF pin (**ANT**) in ANNA-B412 is connected to the single-ended Tx/Rx antenna connection of the 2.4 GHz radio transceiver in nRF52833 chip. The nRF52833 chip has an integrated balun but requires an external filter/matching circuitry which is integrated inside of the ANNA-B412 module. The RF pin (**ANT**) of the module is matched to 50 Ω.

The internal antenna pin (**ANT_INT**) of ANNA-B412 is connected to the feeding point of the internal chip antenna in the module. In addition to the **ANT_INT** pin, three pins on ANNA-B412 (**ANT_PCB**, **ANT_GND1** and **ANT_GND2**) are also connected to the internal antenna. Matching circuitry for the internal antenna is also integrated in the ANNA-B412 module.

ANNA-B412 offers both internal and external antenna options:

- With the internal chip antenna option, the **ANT** pin shall be connected to the feeding point of the internal antenna through the **ANT_INT** pin of the module. The **ANT_PCB** pin or the **ANT_GND1** and **ANT_GND2** pins shall be connected to an external antenna strip. The pins that need to be connected, **ANT_PCB** or **ANT_GND1** and **ANT_GND2**, depends on the physical placement of the module in the application design.
- When implementing an external antenna option, the external antenna or antenna connector shall be connected to **ANT** pin through a controlled impedance trace.

 For information about antenna reference designs, integration instructions, and approved external antennas, see also the ANNA-B4 system integration manual [\[3\]](#).

2.2.2 Near Field Communication (NFC)

ANNA-B412 includes a Near Field Communication interface that can operate as a 13.56 MHz NFC tag at a bit rate of 106 kbps.

As an NFC tag, data can be read from or written to ANNA-B412 using an NFC reader. ANNA-B412 modules are not capable of reading other tags or initiating NFC communications.

Two pins are available for connecting to an external NFC antenna: **NFC1** and **NFC2**.

2.2.3 Direction Finding (AoA/AoD)

ANNA-B412 modules can support a location Bluetooth 5.1 service called Bluetooth Direction Finding. The service is based on two solution architectures: Angle of Arrival (AoA) and Angle of Departure (AoD). Bluetooth Direction Finding is supported in 1 Mbps and 2 Mbps Bluetooth LE modes and is used for indoor positioning, wayfinding, and asset tracking.

This phase-based location service requires antenna arrays, estimation algorithms, and processing power to triangulate and detect the direction of a Bluetooth signal with sub-meter accuracy. The AoA receiver and AoD transmitter use antenna arrays, where individual antennas in the array are switched on one by one. This switching sequence allows the direction of a peer device to be calculated. The derived IQ samples are used to determine the relative path lengths between the antenna pairs and subsequent location of the transmitter.

ANNA-B412 modules that support the Bluetooth 5.1 location service cannot run regular u-connectXpress but requires u-connectLocate software [9] from u-blox. Currently, u-connectLocate software is only available for [NINA-B41 series](#) modules. [Contact](#) your local support team for information concerning the availability of ANNA-B412 u-connectLocate software.

For information about evaluating Bluetooth 5.1 direction finding and indoor positioning using Angle-of-Arrival methodology, see also the XPLR-AOA explorer kits user guide [10].

2.3 System functions

ANNA-B412 modules are power-efficient devices that can operate in different power saving modes and configurations. The various functional parts of ANNA-B412 can be powered off when they are not needed, and complex wake-up events can be generated from different external and internal inputs.

2.3.1 Module power ON

ANNA-B412 modules can be switched on or rebooted in one of the following ways:

- Supply a valid supply voltage to the **VCC** pin
- Issuing a reset of the module. See also [Module reset](#).
- Rising voltage level on **UART_DSR** pin

2.3.2 Power modes

For optimizing power consumption, ANNA-B412 supports several different power modes:

- ACTIVE mode
- STANDBY mode
- SLEEP mode

Depending on the application, the module spends most of its time in either standby or sleep mode to minimize current consumption. The radio part of the module operates independently from the CPU.

2.3.2.1 ACTIVE mode

ANNA-B412 is in ACTIVE mode when it is transmitting or receiving at high speed and the CPU is running at full speed. When the module stops transmitting, ANNA-B412 automatically leaves ACTIVE mode and enters STANDBY mode.

When waking up from standby mode to active mode, an event can also be triggered by:

- The on-board Real Time Counter (RTC)
- The radio interface
- Detection of an NFC field

2.3.2.2 STANDBY mode

Standby mode is one of the power saving modes that powers down the module but keeps the system RAM and configuration intact. It also allows for complex, autonomous, power-up events, including periodic RTC events and radio events.

The following events can be used to bring the module out of standby mode:

- Internal wake-up events from the RTC, radio, NFC, and so on.
- Analog or digital sensor events (programmable voltage level or edge detection)

The module is clocked at 32.768 kHz in standby mode. The clock is either generated by its internal RC-oscillator or an external 32.768 kHz crystal.

2.3.2.3 SLEEP mode

Sleep mode is the deepest power-saving mode. During sleep mode, all functionality is stopped to ensure minimum power consumption. The module needs an external event to wake up from sleep mode. The module always reboots after waking up from sleep mode.

The u-connectXpress software can be configured to enter or exit the sleep mode with the UART **DSR** pin.

2.3.3 Module power OFF

There is no dedicated pin to power off ANNA-B412 modules. You can configure the UART **DSR** pin to enter or exit the sleep mode, which essentially powers down the module. See also [Module reset](#).

An under-voltage (brown-out) shutdown occurs when the VCC supply of the module drops below the minimum limit of the operating range. In these instances, it is not possible to store the current parameter settings in the non-volatile memory of the module.

2.3.4 Module reset

ANNA-B412 modules can be reset in one of the following ways:

- Applying a low logic level on the **RESET_N** pin, which is configured as input high internally, the pin is driven to low. This causes an “external” or “hardware” reset of the module. The prevailing parameter settings are not saved in the non-volatile module memory and a proper network detach is not performed during the “external” or “hardware” reset.
- Using the `AT+CPWROFF` command to initiate an “internal” or “software” reset of the module. The current parameter settings are saved in the non-volatile module memory and a proper network detach is performed.

2.4 Low frequency clock

ANNA-B412 modules use two clocks: one high frequency clock and one low frequency clock. The high frequency clock is provided on-module by a high-accuracy 32 MHz crystal. The low frequency clock can either be provided internally by the RC oscillator or externally by a 32.768 kHz crystal. To reach minimum current consumption in the standby power mode an external high precision 20 ppm 32.768 kHz crystal must be used. For further information, see also the ANNA-B4 system integration manual [3].

 For information about the external 32.768 kHz crystal operating parameters and performance of the clock, see [Flash memory](#).

 When using an external crystal with ANNA-B412 at operating temperatures above 85 °C, LFXO debounce time must be set to 0.50 s. With pre-flashed u-connectXpress software, LFXO debounce time is set to 0.25 s, which is the value for normal operating temperature (-40 to 85°C) conditions. Using ANNA-B412 modules with the pre-flashed u-connectXpress software at operating temperatures above 85 °C may cause boot up issues. [Contact](#) your local support team for using ANNA-B412 at operating temperature above 85 °C.

2.5 System interfaces

This section describes the ANNA-B412 system interfaces. See also the u-connectXpress AT commands manual [2] and u-connectXpress software user guide [4] for more information about how the interfaces are controlled using AT commands.

2.5.1 GPIO

ANNA-B412 modules have a versatile pin-out. In an un-configured state, ANNA-B412 supports a total of 19 GPIO pins with no analog interfaces. All interfaces or functions must be allocated to a GPIO pin before use.

2.5.2 UART

ANNA-B412 supports two 4-wire universal asynchronous receiver/transmitter (UART) interfaces: one primary and one secondary interface.

The 4-wire UART interfaces support hardware flow control and a wide range of baud rates up to 1 Mbps. Other characteristics of the UART interfaces include:

- Default baud rate is 115200 and frame configuration is 8N1, meaning eight (8) data bits, no (N) parity bit, and one (1) stop bit.
- Frames are transmitted in such a way that the least significant bit (LSB) is transmitted first.
- Pin configuration:
 - **TXD**, data output pin
 - **RXD**, data input pin
 - **RTS**, Request To Send, flow control output pin (optional)
 - **CTS**, Clear To Send, flow control input pin (optional)
- Hardware flow control or no flow control is supported.

 Power saving indication available on the hardware flow control output (**RTS** pin): The line is driven to the OFF state when the module is not ready to accept data signals.

2.5.2.1 Primary UART

The primary UART interface is used for communicating with ANNA-B412 modules from a host controller. It can be used for configuring the modules and transferring data to or from a Bluetooth LE link or any connected sensor. The primary interface has a fixed pin configuration that may not be changed.

In addition to the commonly used **RXD**, **TXD**, **CTS**, and **RTS** signals, the u-connectXpress software configures **DSR** and **DTR** signals to the UART interface. Note that these signals are not used as originally intended but are used to control the state of the ANNA-B412 module.

The **DSR** signal can be used to:

- Enter the command mode
- Disconnect and/or toggle connectable status
- Enable/disable the rest of the UART interface
- Enter/wake up from the sleep mode

The DTR signal can be used to indicate:

- System mode (data or command mode)
- If a Serial Port Service (SPS) peer is connected
- If a bonded peer is connected
- If there is an active Bluetooth LE Generic Access Profile (GAP) connection

2.5.2.2 Secondary UART

The secondary UART interface can be used to "daisy chain" UART connections. It is useful in resource constrained systems, where the host controller only has one UART interface available. To use it, ANNA-B412 module is configured to become a UART bridge, and UART data sent over the primary UART interface flows into the secondary UART interface.

The secondary UART interface pins can be freely configured to any free GPIO pins. It uses four signals: **RXD, TXD, CTS** and **RTS**.

2.5.3 u-blox Serial Port Service (SPS)

The serial port service feature enables serial port emulation over Bluetooth LE.

2.5.4 System status signals

The RED, GREEN, and BLUE signals are used to signal the system status of ANNA-B412 modules, as shown in [Table 2](#). These active-low signals are normally routed to an RGB LED to provide a visual indication of the status of ANNA-B412 modules.

Mode	Status	RGB LED color	RED	GREEN	BLUE
Data mode/Extended Data mode (EDM)	IDLE	Green	HIGH	LOW	HIGH
Command mode	IDLE	Orange	LOW	LOW	HIGH
EDM/Data mode, Command mode	CONNECTING	Purple	LOW	HIGH	LOW
EDM/Data mode Command mode	CONNECTED*	Blue	HIGH	HIGH	LOW

Table 2: System status indication

*= LED flashes on data activity

 CONNECTING and CONNECTED reflect the u-blox SPS connection status.

2.5.5 System control signals

The following input signals are used to control the system:

- **RESET_N** is used to reset the system. See also [Module reset](#).
- If **SWITCH_2** is driven low during start up, the UART serial settings are restored to their default values.
- **SWITCH_2** can be used to open a Bluetooth LE connection with a peripheral device.
- If both **SWITCH_1** and **SWITCH_2** are driven low during startup, the system enters bootloader mode.
- If both **SWITCH_1** and **SWITCH_2** are driven low during start up and held low for 10 seconds, the system exits the bootloader mode and restores all settings to their factory default.

3 Pin definition

3.1 ANNA-B412 pin assignment

Figure 3 shows the pinout and pin configuration of ANNA-B412, where:

- GND pins are shown in grey in Figure 3.
- Follow this pin layout when using the u-connectXpress software. No interfaces can be moved or added. For more information about the pins, see also Table 3.

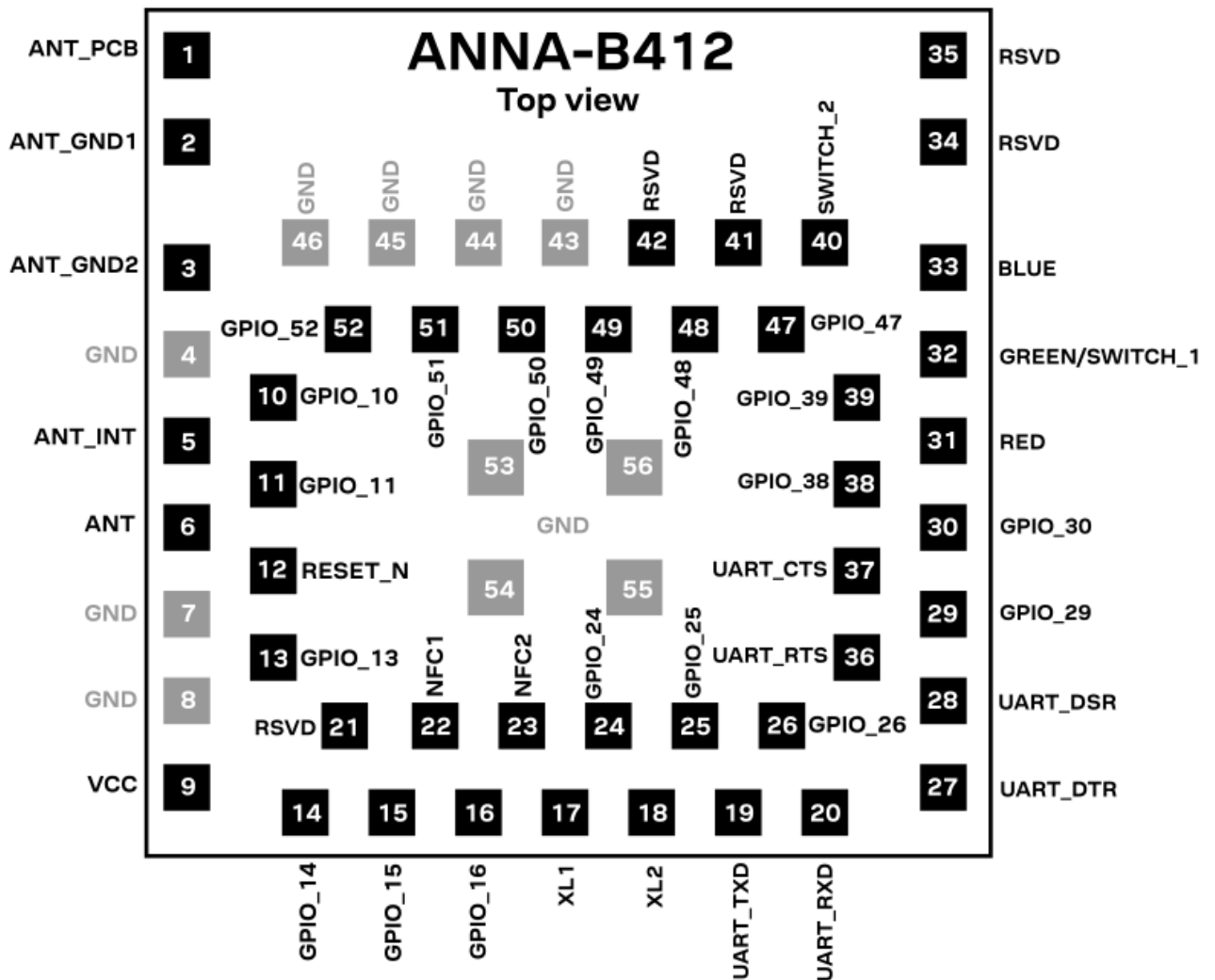

Figure 3: ANNA-B412 pin assignment (top view)

No.	Name	I/O	Description	Remarks
1	ANT_PCB	I/O	Antenna pattern on carrier board if the module is mounted in a corner.	Should only be connected if the module is mounted at a corner of a carrier PCB. See also 2.4 GHz radio and internal antenna .
2	ANT_GND1	-	Antenna ground pattern if the module is mounted in the middle of a side.	Should only be connected if the module is mounted on the edge of a carrier PCB. See also 2.4 GHz radio and internal antenna .
3	ANT_GND2	-	Antenna grounding if the module is mounted in the middle of a side.	Should only be connected if the module is mounted on the edge of a carrier PCB. See also 2.4 GHz radio and internal antenna .
4	GND	-	Ground	
5	ANT_INT	I/O	Feeding to internal antenna of the module.	Connect to ANT pin if the internal antenna is used. See also 2.4 GHz radio and internal antenna .
6	ANT	I/O	Tx/Rx antenna interface.	50 Ω nominal characteristic impedance. Connect to ANT pin if the internal antenna is used. See also 2.4 GHz radio and internal antenna .
7-8	GND	-	Ground	
9	VCC	I	Module supply voltage input	1.7-3.6 V range.
10	GPIO_10	I/O	u-connectXpress IO pin	Can be used for manual digital I/O
11	GPIO_11	I/O	u-connectXpress IO pin	Can be used for manual digital I/O
12	RESET_N	I	System reset input	Active low
13	GPIO_13	I/O	u-connectXpress IO pin	Can be used for manual digital I/O
14	GPIO_14	I/O	u-connectXpress IO pin	Can be used for manual digital I/O
15	GPIO_15	I/O	u-connectXpress IO pin	Can be used for manual digital I/O
16	GPIO_16	I/O	u-connectXpress IO pin	Can be used for manual digital I/O
17	XL1	I	Connection for 32.768 kHz crystal	If not used ground XL1 and XL2.
18	XL2	I	Connection for 32.768 kHz crystal	If an external clock source is used instead of a crystal: <ul style="list-style-type: none"> - Apply external low swing signal to XL1 and ground XL2. - Apply external full swing signal to XL1 and leave XL2 grounded.
19	UART_TXD	O	UART data output	Also used by the bootloader
20	UART_RXD	I	UART data input	Also used by the bootloader
21	RSVD	-	RESERVED pin	Leave unconnected
22	NFC1	I/O	NFC pin 1	
23	NFC2	I/O	NFC pin 2	
24	GPIO_24	I/O	u-connectXpress IO pin	Can be used for manual digital I/O
25	GPIO_25	I/O	u-connectXpress IO pin	Can be used for manual digital I/O
26	GPIO_26	I/O	u-connectXpress IO pin	Can be used for manual digital I/O
27	UART_DTR	O	UART data terminal ready signal	Used to indicate system status
28	UART_DSR	I	UART data set ready signal	Used to change the system modes
29	GPIO_29	I/O	u-connectXpress IO pin	Can be used for manual digital I/O
30	GPIO_30	I/O	u-connectXpress IO pin	Can be used for manual digital I/O
31	RED	O	RED system status signal	Active low, should be routed to an RGB LED
32	GREEN/SWITC H_1	I/O	This signal is multiplexed: GREEN - System status signal. SWITCH_1 - Multiple functions	Active low. GREEN: Should be routed to an RGB LED. SWITCH_1: See also System control signals .
33	BLUE	O	BLUE system status signal	Active low, should be routed to an RGB LED
34	RSVD	-	RESERVED pin	Leave unconnected
35	RSVD	-	RESERVED pin	Leave unconnected
36	UART_RTS	O	UART request to send control signal	Used only when hardware flow control is enabled

No.	Name	I/O	Description	Remarks
37	UART_CTS	I	UART clear to send control signal	Used only when hardware flow control is enabled
38	GPIO_38	I/O	u-connectXpress IO pin	Can be used for manual digital I/O
39	GPIO_39	I/O	u-connectXpress IO pin	Can be used for manual digital I/O
40	SWITCH_2	I/O	Multiple functions	Active low. See also System control signals .
41	RSVD	-	RESERVED pin	Leave unconnected
42	RSVD	-	RESERVED pin	Leave unconnected
43-46	GND	-	Ground	
47	GPIO_47	I/O	u-connectXpress IO pin	Can be used for manual digital I/O
48	GPIO_48	I/O	u-connectXpress IO pin	Can be used for manual digital I/O
49	GPIO_49	I/O	u-connectXpress IO pin	Can be used for manual digital I/O
50	GPIO_50	I/O	u-connectXpress IO pin	Can be used for manual digital I/O
51	GPIO_51	I/O	u-connectXpress IO pin	Can be used for manual digital I/O
52	GPIO_52	I/O	u-connectXpress IO pin	Can be used for manual digital I/O
53-56	GND	-	Ground	The exposed pins in the center of the module should be connected to GND

Table 3: ANNA-B412 with u-connectXpress software pinout

4 Electrical specifications

Stressing the device above one or more of the ratings listed in the [Absolute maximum ratings](#) section can cause permanent damage. These are stress ratings only. Operating the module at these or at any conditions other than those specified in the [Operating conditions](#) should be avoided. Exposure to absolute maximum rating conditions for extended periods may affect device reliability.

All given application information is only advisory and does not form part of the specification.

4.1 Absolute maximum ratings

Symbol	Description	Condition	Min	Max	Unit
VCC	Module supply voltage	Input DC voltage at VCC pin	-0.3	3.9	V
V_DIO	Digital pin voltage	Input DC voltage at any digital I/O pin, VCC ≤ 3.6 V	-0.3	VCC + 0.3	V
		Input DC voltage at any digital I/O pin, VCC > 3.6 V	-0.3	3.9	V
P_ANT	Maximum power at receiver	Input RF power at antenna pin		+10	dBm

Table 4: Absolute maximum ratings

The product is not protected against overvoltage or reversed voltages. Use appropriate protection devices to avoid voltage spikes that might otherwise exceed the power boundary values shown in [Table 4](#).

4.1.1 Maximum ESD ratings

Parameter	Min	Typical	Max	Unit	Remarks
ESD sensitivity for all pins except ANT pin			2**	kV	Human body model class 2 according to JEDEC JS001
			500**	V	Charged device model according to JESD22-C101
ESD indirect contact discharge			±8*	kV	According to EN 301 489-1

*Tested on ANNA-B4 evaluation board.

**Target values only - module qualification ongoing

Table 5: Maximum ESD ratings

ANNA-B412 modules are Electrostatic Sensitive Devices that require special precautions while handling. See also section [ESD precautions](#) for ESD handling instructions.

4.2 Operating conditions

Unless otherwise specified, all given operating condition specifications are taken for an ambient temperature of 25 °C with a supply voltage of 3.3 V.

Operation beyond the specified operating conditions is not recommended and extended exposure beyond them can affect device reliability.

4.2.1 Operating temperature range

Parameter	Min	Max	Unit
Storage temperature	-40	+105	°C
Operating temperature	-40	+105	°C

Table 6: Temperature range

4.2.2 Supply/Power pins

Symbol	Parameter	Min	Typ	Max	Unit
VCC	Input supply voltage	1.7	3.3	3.6	V
t_RVCC	Supply voltage rise time			60	ms

Table 7: Input characteristics of voltage supply pins

4.2.3 Current consumption

Table 8 shows the current consumption of ANNA-B412 during some typical use cases when using the u-connectXpress software. A 20 ppm external crystal is used for low frequency clock of the ANNA-B412 device under test (DUT).

Condition		3.3 V VCC		1.8 V VCC	
Mode	Condition	Average	Peak	Average	Peak
Active	Advertising (u-blox Serial Service, Apple iBeacon, etc.) at 1 s intervals with +8 dBm output power and 31 bytes payload, and CPU and UART interface running.				
	1 Mbit/s PHY	0.78 mA	21 mA	0.85 mA	36 mA
	CODED PHY	0.88 mA	21 mA	1.03 mA	36 mA
Standby	Advertising (u-blox Serial Service, Apple iBeacon etc.) at 1 s intervals with +8 dBm output power and 31 bytes payload				
	1 Mbit/s PHY	35 μ A	18 mA	50 μ A	32 mA
	CODED PHY	141 μ A	19 mA	229 μ A	33 mA
Active	Connected as peripheral, 50 ms connection interval, +8 dBm output power, no data throughput, CPU and UART interface is running				
	1 Mbits/s PHY	0.85 mA	21 mA	0.95 mA	37 mA
	2 Mbits/s PHY	0.84 mA	21 mA	0.93 mA	37 mA
	CODED PHY	1.13 mA	21 mA	1.40 mA	37 mA
Standby	Connected as peripheral, 50 ms connection interval, +8 dBm output power, no data throughput				
	1 Mbits/s PHY	124 μ A	18 mA	163 μ A	31 mA
	2 Mbits/s PHY	109 μ A	18 mA	137 μ A	31 mA
	CODED PHY	409 μ A	18 mA	627 μ A	31 mA
Sleep	UART DSR pin is used to enter the sleep mode. No RAM retention.	400 nA	-	355 nA	-

Table 8: Current consumption during typical use cases

The standby mode advertising and connected use cases described in **Table 8** list the average current consumption of an ANNA-B412 module when using the typical configuration of a 1 s Bluetooth advertising interval and a 50 ms connection interval.

 Make sure that the configured output power of your application product does not exceed the maximum allowed limits for your intended target market(s). For information about the applicable limits and other regulatory requirements for each market area, see also the ANNA-B4 system integration manual [3].

4.2.4 RF performance

Parameter	Test condition	Min	Typ	Unit
Receiver input sensitivity	Conducted at 25 °C, 1 Mbit/s Bluetooth LE mode		-94	dBm
	Conducted at 25 °C, 2 Mbit/s Bluetooth LE mode		-91	dBm
	Conducted at 25 °C, 125 kbit/s Bluetooth LE mode		-103	dBm
Maximum output power	Conducted at 25 °C		+8	dBm
Internal antenna gain	Mounted on an EVB-ANNA-B4		+0.5	dBi

Table 9: RF performance

4.2.5 Startup times

Parameter	Time	Unit
Hardware reset (toggling the RESET_N pin of module)	1.37	s
Software reset (reboot using AT command)	1.26	s

Table 10: Startup times

4.2.6 Flash memory

Table 11 describes the endurance and retention characteristics for the flash memory.

Flash memory	Comment	Min.	Unit
Endurance		10 000	Write/erase cycles
Retention at 85 °C		10	Years
Retention at 105 °C	Limited to 1000 write/erase cycles	3	Years
Retention at 105 °C–85 °C, execution split	Limited to 1000 write/erase cycles. 75% execution time at 85 °C or less	6.7	Years

Table 11: Flash memory endurance and retention

4.2.7 LFXO crystal specifications

Symbol	Parameter	Typ.	Max.	Unit
F_{NOM_LFXO}	Crystal frequency	32.768	-	kHz
$F_{TOL_LFXO_BLE}$	Frequency tolerance, Bluetooth low energy applications ¹	-	±20	ppm
C_{L_LFXO}	Load Capacitance	-	12.5	pF
C_{0_LFXO}	Shunt Capacitance	-	2	pF
R_{S_LFXO}	Equivalent series resistance	-	100	kΩ
C_{pin}	Input Capacitance on XL1 & XL2 pads	5	-	pF

Table 12: 32.768 kHz crystal (LFXO)

¹ $f_{TOL_LFXO_BLE}$ is the maximum allowed for Bluetooth Low Energy (LE) applications. Actual tolerance depends on the crystal used.

4.2.8 ANNA-B412 radiation patterns

Table 13 describes the radiation patterns for ANNA-B412. The antenna radiation test setup utilizes the reference design that comprises an evaluation board with ANNA-B412 situated in the corner of the EVK-ANNA-B412 board. For more information about the antenna reference design, see also the ANNA-B4 system integration manual [3].

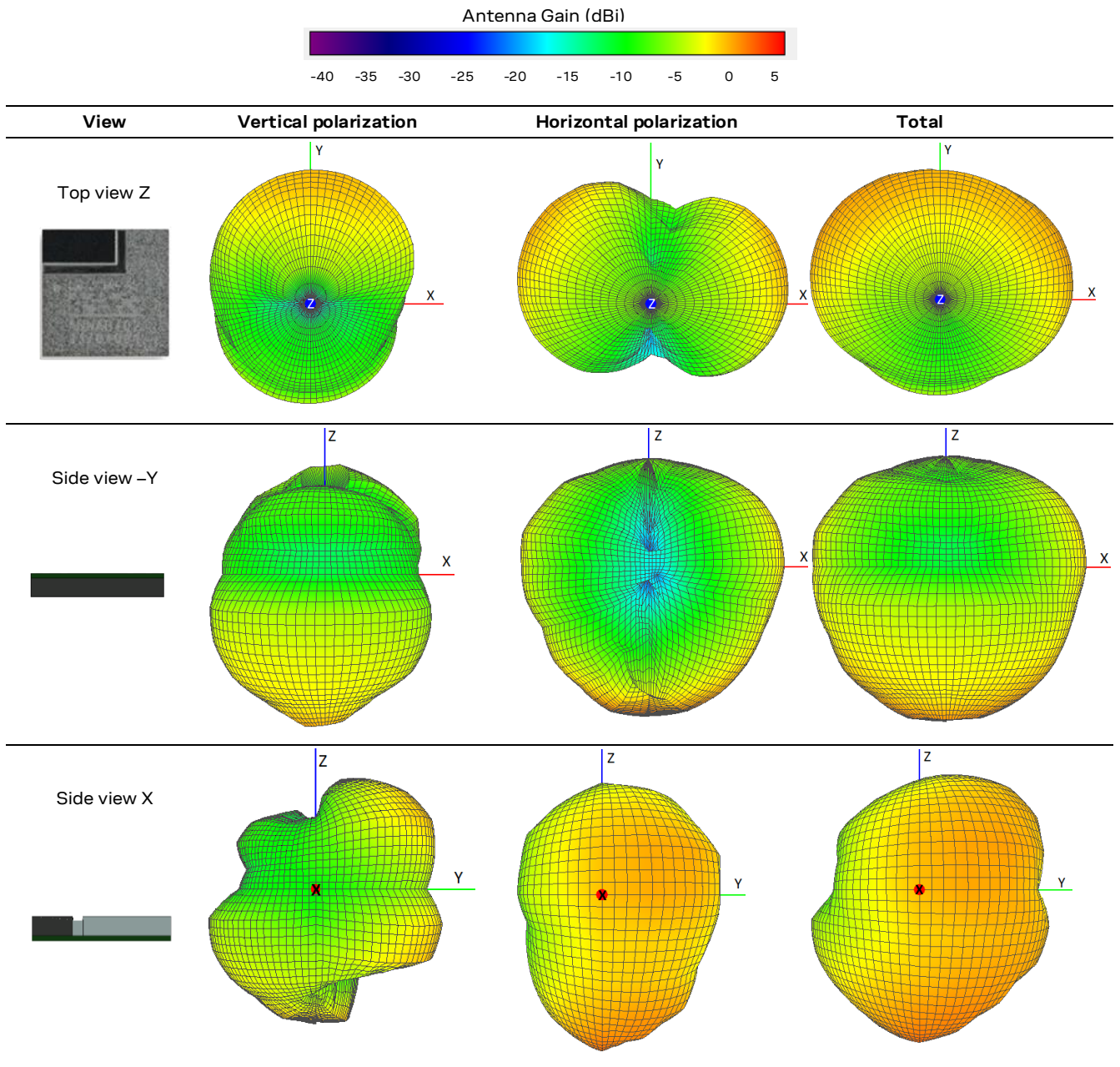

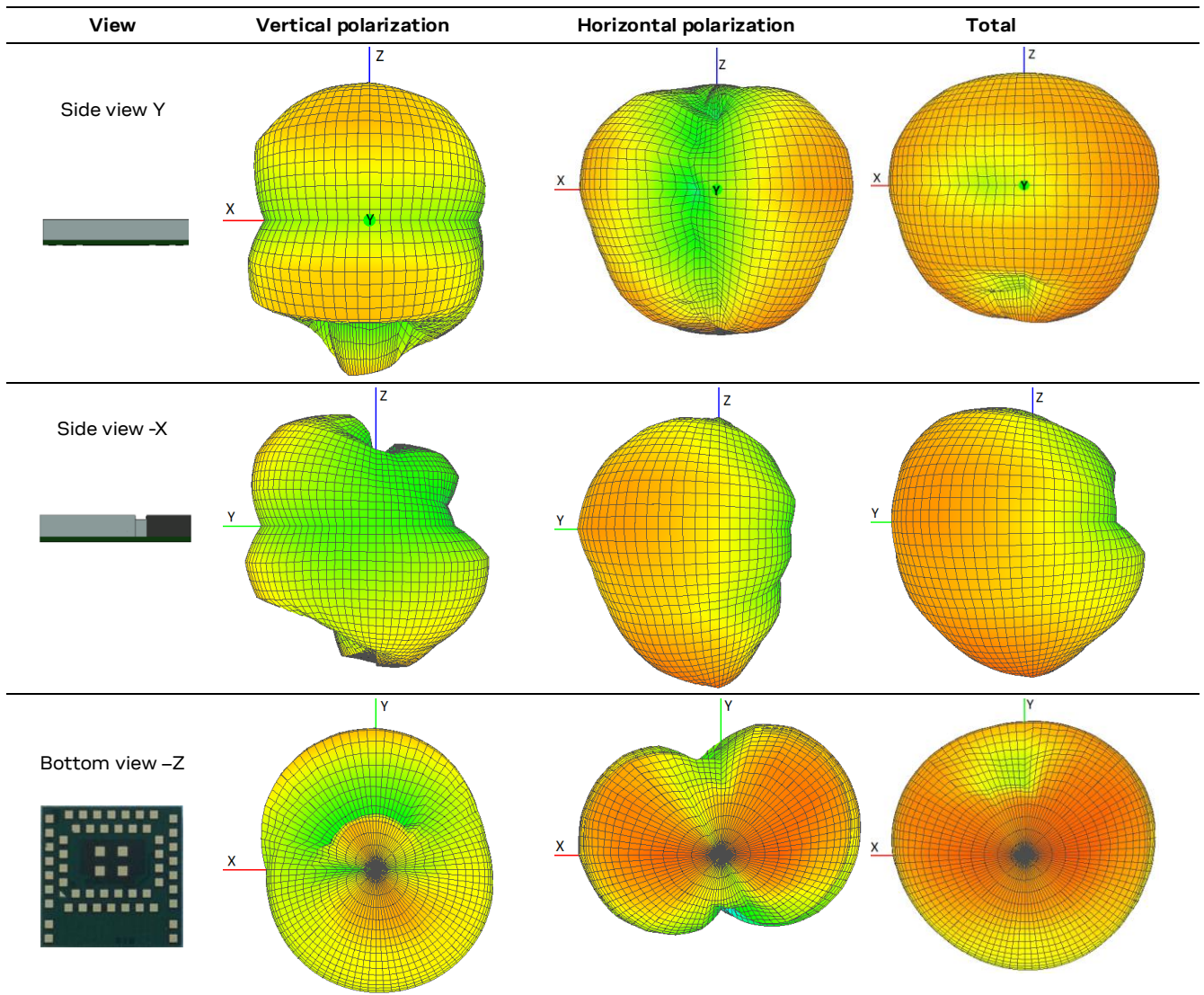

Table 13: Antenna radiation patterns

4.2.9 RESET_N pin

Pin name	Parameter	Min	Typ	Max	Unit	Remarks
RESET_N	Low-level input	0		0.3*VCC	V	
	Internal pull-up resistance		13		kΩ	
	RESET duration			55	ms	Time taken to release a pin reset.

Table 14: RESET_N pin characteristics

4.2.10 Digital pins

Pin name	Parameter	Min	Typ	Max	Unit	Remarks
Any digital pin	Input characteristic: Low-level input	0		0.3*VCC	V	
	Input characteristic: high-level input	0.7*VCC		VCC	V	
	Output characteristic: Low-level output	0		0.4	V	Standard drive strength
	Output characteristic: High-level output	VCC-0.4		VCC	V	Standard drive strength
	Sink/Source current	1	2	4	mA	Standard drive strength
	Rise/Fall time		9 – 25		ns	Standard drive strength, depending on load capacitance
	Input pull-up resistance	11	13	16	kΩ	Can be added to any GPIO pin configured as input
	Input pull-down resistance	11	13	16	kΩ	Can be added to any GPIO pin configured as input
GPIO_22, GPIO_23	Leakage current		1	10	μA	When not configured for NFC and driven to different logic levels

Table 15: Digital pin characteristics

5 Mechanical specifications

Figure 4 shows a side view of the mechanical outline and critical dimensions of the ANNA-B412 package.

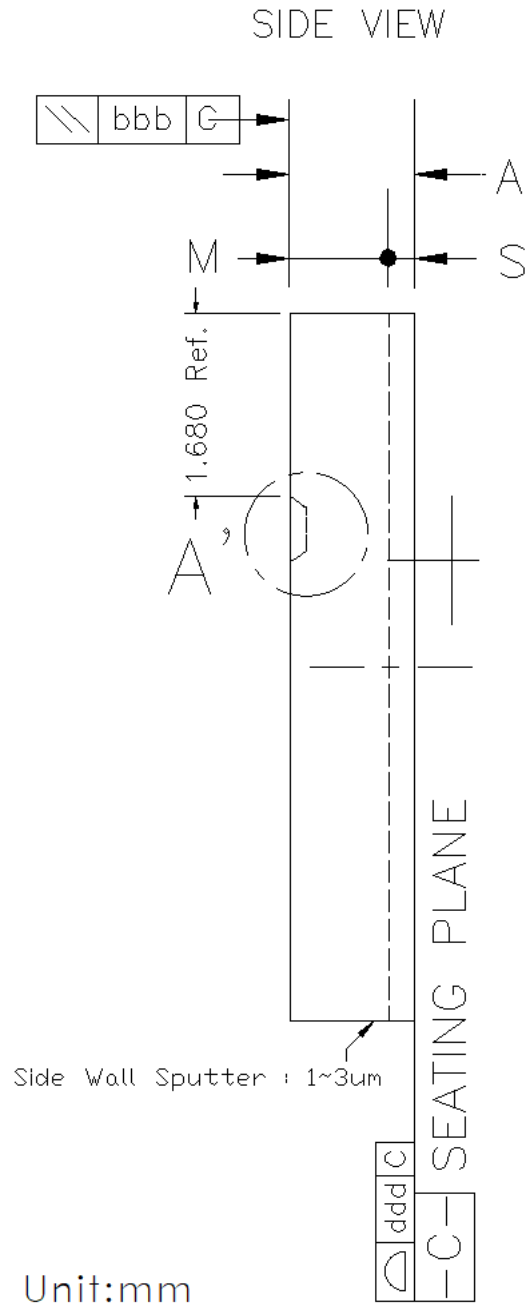

Figure 4: ANNA-B412 physical package – side view

Figure 5 shows a bottom view of the mechanical outline and critical dimensions of the ANNA-B412 package.

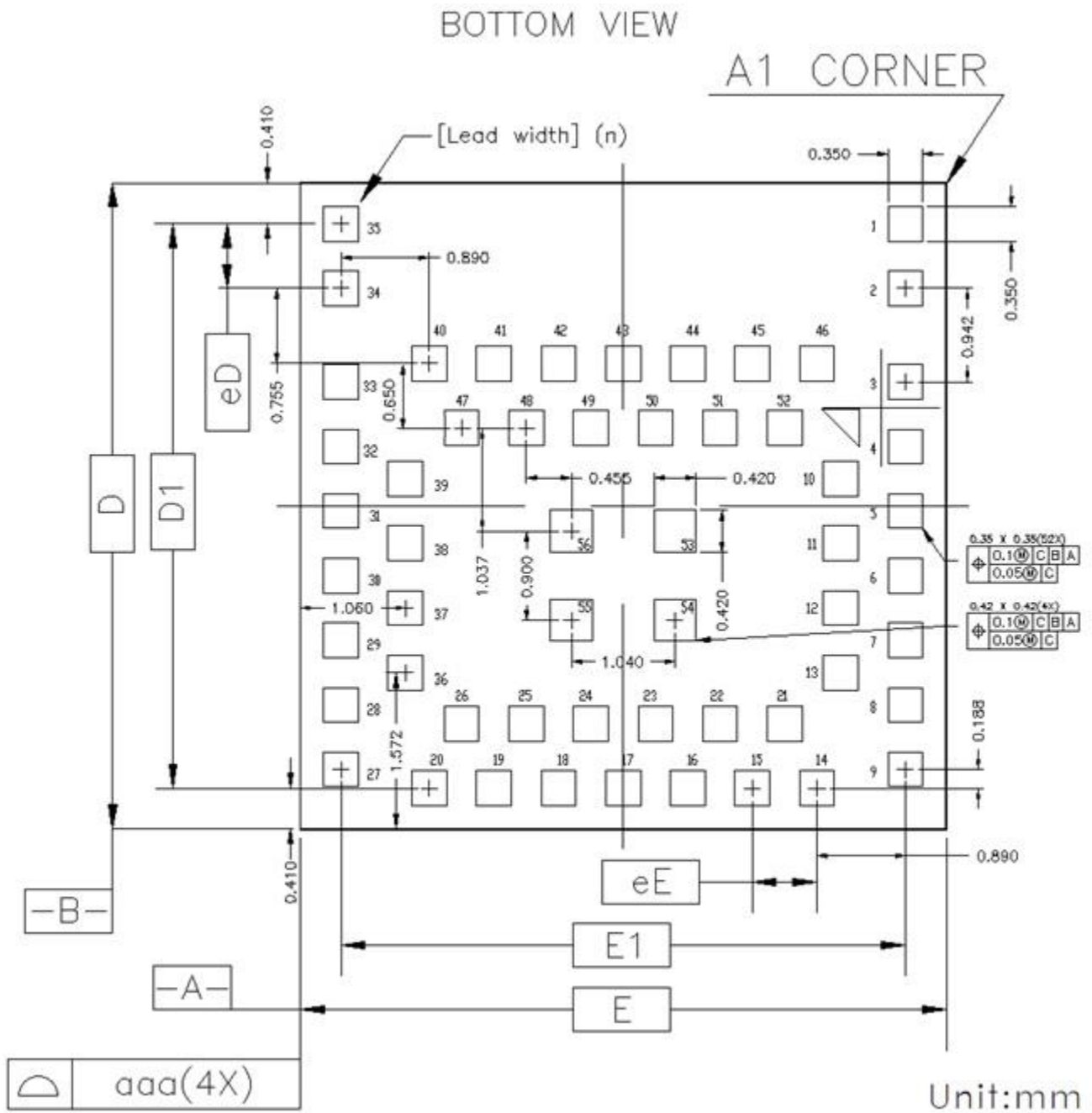

Figure 5: ANNA-B412 physical package outline – bottom view

Figure 6 describes the minimum, nominal, and maximum dimensions together with the symbols for the physical package outline of the ANNA-B412 module.

Description		Symbol	Dimensions(mm)		
			MIN	NOM	MAX
Package :			PIM		
Body Size:	X	E	6.400	6.500	6.600
	Y	D	6.400	6.500	6.600
Lead Pitch :	X	eE	0.650		
	Y	eD	0.650		
Total Thickness :		A	1.150 +/- 0.100		
Mold Thickness :		M	0.910		
Substrate Thickness :		S	0.240		
Lead width:			0.350x0.350 / 0.420x0.420		
Package Edge Tolerance :		aaa	0.100		
Mold Flatness :		bbb	0.100		
Coplanarity:		ddd	0.100		
Lead Count :		n	56		
Edge Lead Center to Center :	X	E1	5.680		
	Y	D1	5.680		

Figure 6: ANNA-B412 physical package - parameters, symbols, and dimensions

6 Qualification and approvals

6.1 Country approvals

The ANNA-B412 module is certified for use in the following countries/regions:

Country/region	ANNA-B412
Europe	Approved
Great Britain (UKCA)	Approved
USA	Approved
Canada	Approved
Japan	Approved
Taiwan	Pending
South Korea	Approved
Brazil	Approved
Australia	Approved
New Zealand	Approved
South Africa	Pending

 For more information about approved antennas and regulatory requirements that must be met when using ANNA-B412 in an end product, see also the ANNA-B4 system integration manual [3].

6.2 Bluetooth qualification



ANNA-B412 module is qualified as an end product in accordance with the Bluetooth 5.1 specification.

Product type	QD ID	Listing date
End product	138767	2022-03-08

Table 16: ANNA-B412 Bluetooth qualified design ID

 For more information about the declaration process for a product using ANNA-B412 please refer to the application note Bluetooth® qualification process – u-connectXpress and nRF5 SDK [11].

7 Product handling

7.1 Packaging

ANNA-B412 modules are delivered as hermetically sealed, reeled tapes to enable efficient production, production lot set-up and tear-down. See also the Packaging information reference guide [1].

7.2 Reels

Information about the reel type for ANNA-B4 modules are provided in Table 17. See also the Packaging information reference guide [1].

Model	Reel type	Reel part number	Qty
ANNA-B412	F	MYR-131-BB	500 pcs/reel

Table 17: Reel type for ANNA-B412

7.3 Tapes

Figure 7 shows the position and orientation of ANNA-B4 modules as they are delivered on tape.

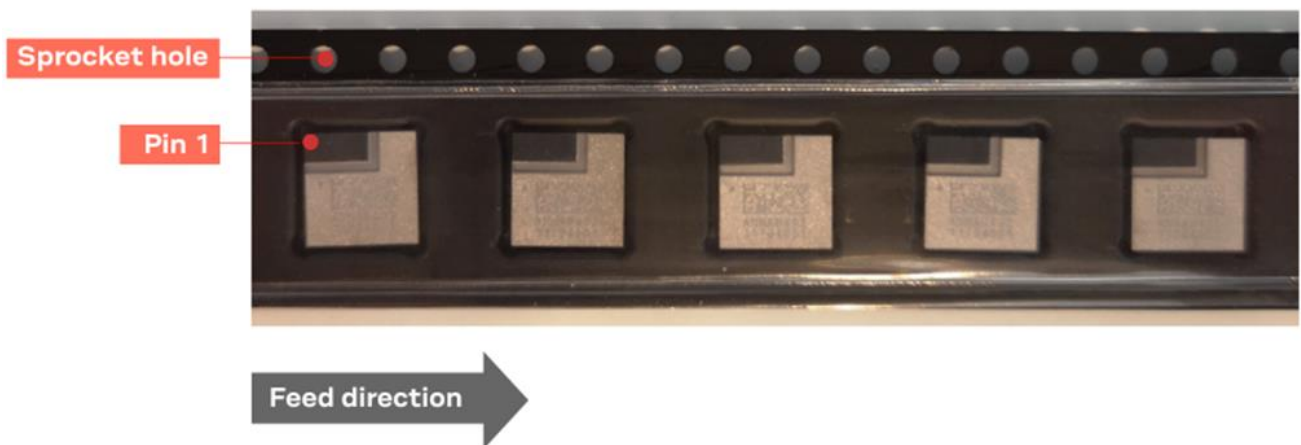

Figure 7: Orientation of ANNA-B4 modules on tape

7.6 ESD precautions

ANNA-B412 modules are Electrostatic Sensitive Devices (ESD) that demand the observance of special handling precautions against static damage. Failure to observe these precautions can result in severe damage to the product. See also [Maximum ESD ratings](#).

Proper ESD handling and packaging procedures must be applied throughout the processing, handling, and operation of any application that incorporates the module. ESD precautions are also relevant when handling the application board on which the module is mounted.

For further information about the handling of ANNA-B412 modules, see also the system integration manual [\[3\]](#).

8 Labelling and ordering information

8.1 Product marking

Figure 9 and Table 18 describe the laser markings on the ANNA-B412 modules.

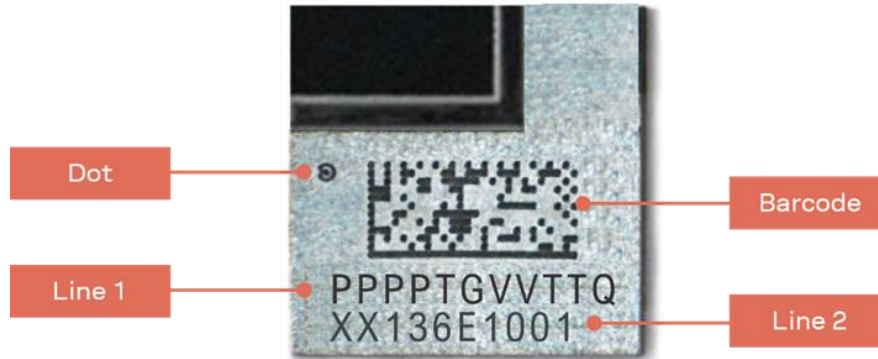

Figure 9: Product marking layout

Item	Description	Example						
Dot	Pin 1 corner indication for assembly orientation	-						
Line 1	Product name, major version, and product grade							
Pos 1–8	Product name	ANNAB412						
Pos 9–10	Major product version	00						
Pos 11	Quality grade	B						
Line 2	Minor version and production date							
Pos 1–2	Minor product version	00						
Pos 3	Last digit of production year	1						
Pos 4–5	Week number of production date	36						
Pos 6–7	Assembly mother lot, last digits	E1						
Pos 8–10	Assembly sub lot number	001						
2D barcode	1	2 3 4 5 6 7	8 9 10	11 12	13 14	15 16		
	Year	Assembly mother lot#		Sub lot#		Strip#	X axis	Y axis
	Example	8	3 6 U B E 1	0 0 1	0 1	0 1	0 1	

Table 18: ANNA-B412 laser marking data

See also [Product identifiers](#) and [Identification codes](#).

8.2 Product identifiers

Table 19 describes the three product identifiers; specifically, the Product name, Ordering code and Type number.

Format	Description	Nomenclature
Product name	Describes the form factor, platform technology and platform variant. Used mostly in product documentation like this data sheet, the product name represents the most common identity for all u-blox products	PPPPTGVV (Line1, position 1–8)
Ordering code	Comprises the product name – with additional identifiers to describe the major product version and quality grade	PPPPTGVVTTQ (Line1, position 1–11)
Type number	Comprises the product name and ordering code – with additional identifiers to describe minor product versions.	PPPP-TGVV-TTQ-XX (Line1, position 1–11) (Line 2, position 1–2)

Table 19: Product code formats

8.3 Identification codes

Table 20 explains the parts of the product code.

Code	Meaning	Example
PPPP	Form factor	ANNA
TG	Platform (Technology and Generation) <ul style="list-style-type: none"> • T – Dominant technology, For example, <ul style="list-style-type: none"> ◦ W: Wi-Fi, ◦ B: Bluetooth • G – Generation 	B4: Bluetooth Generation 4
VV	Variant based on the same platform; range [00...99]	12: default mounting, with internal antenna
TT	Major Product Version	00: first revision
Q	Quality grade <ul style="list-style-type: none"> • A: Automotive • B: Professional • C: Standard 	B: professional grade
XX	Minor product version (not relevant for certification)	Default value is 00

Table 20: Part identification code

8.4 Ordering information

Ordering code	Product
ANNA-B412-00B	ANNA-B412 module with u-connectXpress software and the option to use either an internal antenna or an external antenna.

Table 21: Product ordering codes

Appendix

A Glossary

Abbreviation	Definition
ADC	Analog to digital converter
BLE	Bluetooth low energy
BPF	Band pass filter
CTS	Clear to send
DUT	Device under test
ESD	Electro static discharge
FCC	Federal Communications Commission
GATT	Generic ATtribute profile
GPIO	General purpose input/output
IC	Industry Canada
I ² C	Inter-integrated circuit
LPO	Low power oscillator
MCU	Micro controller unit
MSD	Moisture sensitive device
RF	Radio frequency
RTOS	Real time operating system
SiP	System in package
SPI	Serial peripheral interface
UART	Universal asynchronous receiver/transmitter

Table 22: Explanation of the abbreviations and terms used

Related documents

- [1] Packaging information guide, [UBX-14001652](#)
- [2] u-connectXpress AT commands manual, [UBX-14044127](#)
- [3] ANNA-B4 system integration manual, [UBX-21000517](#)
- [4] u-connectXpress software user guide, [UBX-16024251](#)
- [5] ANNA-B402 product summary, [UBX-20017979](#)
- [6] ANNA-B412 product summary, [UBX-21025292](#)
- [7] ANNA-B112 data sheet, [UBX-18011707](#)
- [8] s-center user guide, [UBX-16012261](#)
- [9] u-connectLocate [product page](#)
- [10] XPLR-AOA explorer kits user guide, [UBX-21004616](#)
- [11] Bluetooth® qualification process – u-connectXpress and nRF5 SDK, [UBX-20009220](#)

 For product change notifications and regular updates of u-blox documentation, register on our website, www.u-blox.com.

Revision history

Revision	Date	Name	Comments
R01	08-Oct-2021	asoh, yach	Initial release.
R02	19-Oct-2021	lalb	Revised document metadata disclosure restriction class.
R03	04-Feb-2022	yach	Updated software to u-connectXpress 1.0, hardware version to 02 and product status to Engineering Sample in Document information section. Updated max radiated output power with external antenna (EIRP) to 13 dBm in Table 1 . Updated information describing Block diagram and the diagram in Figure 1 . Updated current consumption values in Table 8 . Updated internal antenna gain in Table 9 . Renamed section 4.2.6 to LFXO crystal specifications. Updated LFXO frequency tolerance for BLE applications to 20 ppm in Table 12 . Updated antenna radiation patterns in Table 13 . Updated pictures of ANNA-B412 outline and dimensions with better resolution in Figure 4 , Figure 5 and Figure 6 . Removed ambiguous description of operating condition ranges in Electrical specifications . Updated information describing Overview , 2.4 GHz radio and internal antenna , Direction Finding (AoA/AoD) , Moisture sensitivity levels , Reflow soldering , and ESD precautions . Corrected the document links for Related documents .
R04	21-Sep-2022	fkru, yach	Updated product status to Initial production (hardware version to 03) in Document information section. Added details about the completed Bluetooth SIG qualification / listing in Bluetooth qualification section. Removed “pending” in section Country approvals for the now completed country certifications for US, Canada, Europe, Great Britain, Japan, Australia, New Zealand, South Korea, and Brazil. Added information about the supply voltage mode of ANNA-B412 modules in Module supply input (VCC) . Clarified the information regarding using an external crystal with ANNA-B412 at operating temperatures above 85 °C in Low frequency clock . Removed the bullet about non-standard baud rates support in UART section, as it is mostly standard baud rates supported. Revised the orientation of ANNA-B4 modules on tape in Figure 7 . Removed unsupported 500 kbps Bluetooth LE data rate from the ANNA-B412 characteristics summary and deleted this as a test condition for input sensitivity in the RF performance table. Added table date for endurance and data retention data in Flash memory . Added y-direction distance of pad 40 and pad 47 in Figure 5: ANNA-B412 physical package outline – bottom view . Included other minor editorial updates throughout the document.
R05	20-Jan-2023	mapc	Added link to application note about declaration process in Bluetooth qualification . Corrected typo in Near Field Communication (NFC) section to reflect that u-connectXpress currently does not support waking the module from sleep mode with NFC.

Contact

For further support and contact information, visit us at www.u-blox.com/support.