

# DLH SERIES LOW VOLTAGE DIGITAL PRESSURE SENSORS

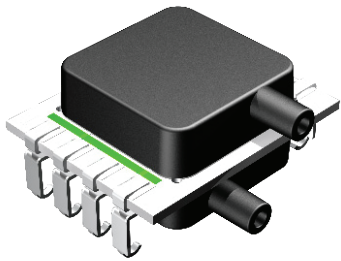

## Features

- 5 to 60 inH2O Pressure Ranges
- 1.68V to 3.6V Supply Voltage Range
- I2C or SPI Interface (Automatically Selected)
- Better than 0.25% Accuracy
- High Resolution 16/17/18 bit Output

## Applications

- Medical Breathing
- Environmental Controls
- HVAC
- Industrial Controls
- Portable/Hand-Held Equipment

## General Description

The DLH Series Mini Digital Output Sensor is based on All Sensors' CoBeam<sup>2</sup>™ Technology. This reduces package stress susceptibility, resulting in improved overall long term stability and vastly improves the position sensitivity.

The digital interface options ease integration of the sensors into a wide range of process control and measurement systems, allowing direct connection to serial communications channels. For battery-powered systems, the sensors can enter very low-power modes between readings to minimize load on the power supply.

These calibrated and compensated sensors provide accurate, stable output over a wide temperature range. This series is intended for use with non-corrosive, non-ionic working fluids such as air, dry gases and the like. A protective parylene coating is optionally available for moisture/harsh media protection.

Standard Pressure Ranges					Equivalent Circuit	
Device	Operating Range	Proof Pressure	Burst Pressure	Nominal Span		
DLH-L05D	±5 inH2O	200 inH2O	300 inH2O	±0.4 * 2 <sup>24</sup> counts		
DLH-L10D	±10 inH2O	200 inH2O	300 inH2O	±0.4 * 2 <sup>24</sup> counts		
DLH-L20D	±20 inH2O	200 inH2O	500 inH2O	±0.4 * 2 <sup>24</sup> counts		
DLH-L30D	±30 inH2O	200 inH2O	500 inH2O	±0.4 * 2 <sup>24</sup> counts		
DLH-L60D	±60 inH2O	200 inH2O	800 inH2O	±0.4 * 2 <sup>24</sup> counts		
DLH-L05G	0 to 5 inH2O	200 inH2O	300 inH2O	0.8 * 2 <sup>24</sup> counts		
DLH-L10G	0 to 10 inH2O	200 inH2O	300 inH2O	0.8 * 2 <sup>24</sup> counts		
DLH-L20G	0 to 20 inH2O	200 inH2O	500 inH2O	0.8 * 2 <sup>24</sup> counts		
DLH-L30G	0 to 30 inH2O	200 inH2O	500 inH2O	0.8 * 2 <sup>24</sup> counts		
DLH-L60G	0 to 60 inH2O	200 inH2O	800 inH2O	0.8 * 2 <sup>24</sup> counts		
Pressure Sensor Maximum Ratings				Environmental Specifications		
Supply Voltage (Vs)	3.63 Vdc			<b>Temperature Ranges</b>		
Common Mode Pressure	10 psig			<b>Compensated:</b>		
Lead Temperature (soldering 2-4 sec.)	270 °C			Commercial	0°C to 70°C	
				Industrial	-20°C to 85°C	
				Operating	-25°C to 85 °C	
				Storage	-40°C to 125 °C	
				<b>Humidity Limits (non condensing)</b>	0 to 95% RH	

## Performance Characteristics for DLH Series - Commercial and Industrial Temperature Range

ALL PARAMETERS ARE MEASURED AT 3.3V  $\pm$ 5% EXCITATION AND 25C UNLESS OTHERWISE SPECIFIED (NOTE 9). PRESSURE MEASUREMENTS ARE WITH POSITIVE PRESSURE APPLIED TO PORT B.

Parameter	Min	Typ	Max	Units	Notes	
<b>Output Span (FSS)</b>					1	
LxxD	-	$\pm 0.4 * 2^{24}$	-	Dec Count		
LxxG	-	$0.8 * 2^{24}$	-	Dec Count		
<b>Offset Output @ Zero Diff. Pressure (OS<sub>dig</sub>)</b>					-	
LxxD	-	$0.5 * 2^{24}$	-	Dec Count		
LxxG	-	$0.1 * 2^{24}$	-	Dec Count		
<b>Total Error Band</b>					2	
L01x, L02x	-	$\pm 0.75$	$\pm 1.5$	%FSS		
L05x, L10x, L20x, L30x, L60x	-	$\pm 0.50$	$\pm 1.0$	%FSS		
<b>Span Temperature Shift</b>	-	$\pm 0.25$	-	%FSS	3	
<b>Offset Temperature Shift</b>	-	$\pm 0.25$	-	%FSS	3	
<b>Offset Warm-up Shift</b>	-	$\pm 0.20$	-	%FSS	4	
<b>Offset Position Sensitivity (<math>\pm 1g</math>)</b>	-	$\pm 0.10$	-	%FSS	-	
<b>Offset Long Term Drift (One Year)</b>	-	$\pm 0.30$	-	%FSS	-	
<b>Linearity, Hysteresis Error</b>					6	
LxxD	-	$\pm 0.25$	-	%FSS		
LxxG	-	$\pm 0.10$	-	%FSS		
<b>Pressure Digital Resolution - No Missing Codes</b>					-	
16-bit Option	15.3	15.5	-	bit		
17-bit Option	16.3	16.5	-	bit		
18-bit Option	17.0	17.5	-	bit		
<b>Temperature Output</b>					-	
Resolution	-	16	-	bit		
Overall Accuracy	-	2	-	$^{\circ}C$		
<b>Supply Current Requirement</b>					5, 7, 8	
During Active State (ICC <sub>Active</sub> )	-	1.5	2.0	mA		
During Idle State (ICC <sub>Idle</sub> )	-	100	250	nA		
<b>Power On Delay</b>	-	-	2.5	ms	5	
<b>Data Update Time (t<sub>DU</sub>)</b>		(see table below)			ms	5, 7

Calibrated Resolution	Measurement Command										Units
	Single		Average2		Average4		Average8		Average16		
	Typ	Max	Typ	Max	Typ	Max	Typ	Max	Typ	Max	
16 bit option	2.80	3.1	5.40	6.0	10.60	11.7	21.00	23.2	41.80	46.0	ms
17 bit option	3.20	3.6	6.20	6.9	12.20	13.5	24.20	26.7	48.20	53.1	ms
18 bit option	3.70	4.1	7.20	8.0	14.20	15.7	28.20	31.1	56.20	61.9	ms

See the following page for performance characteristics notes.

## I2C / SPI Electrical Parameters for DLH Series

Parameter	Symbol	Min	Typ	Max	Units	Notes
Input High Level	-	80.0	-	100	% of Vs	5
Input Low Level	-	0	-	20.0	% of Vs	5
Output Low Level	-	-	-	10.0	% of Vs	5
I2C Pull-up Resistor	-	1000	-	-	Ω	5
I2C Load Capacitance on SDA, @ 400 kHz	C <sub>SDA</sub>	-	-	200	pF	5
I2C Input Capacitance (each pin)	C <sub>I2C_IN</sub>	-	-	10.0	pF	5
I2C Address			41		decimal	

## Pressure Output Transfer Function

$$Pressure(inH_2O) = 1.25 \times \left( \frac{P_{out_{dig}} - OS_{dig}}{2^{24}} \right) \times FSS(inH_2O)$$

Where:

$P_{out_{dig}}$  Is the sensor 24-bit digital output.

$OS_{dig}$  Is the specified digital offset  
 For Gage Operating Range sensors:  $0.1 * 2^{24}$   
 For Differential Operating Range sensors:  $0.5 * 2^{24}$

$FSS(inH_2O)$  The sensor Full Scale Span in inches H<sub>2</sub>O  
 For Gage Operating Range sensors: Full Scale Pressure  
 For Differential Operating Range sensors: 2 x Full Scale Pressure.

## Temperature Output Transfer Function

$$Temperature (°C) = \left( \frac{T_{out_{dig}} * 125}{2^{24}} \right) - 40$$

Where:

$T_{out_{dig}}$  The sensor 24-bit digital temperature output.  
 (Note that only the upper 16 bits are significant)

### Specification Notes

- NOTE 1: THE SPAN IS THE ALGEBRAIC DIFFERENCE BETWEEN FULL SCALE DECIMAL COUNTS AND THE OFFSET DECIMAL COUNTS.
- NOTE 2: TOTAL ERROR BAND CONSISTS OF OFFSET AND SPAN TEMPERATURE AND CALIBRATION ERRORS, LINEARITY AND PRESSURE HYSTERESIS ERRORS, OFFSET WARM-UP SHIFT, OFFSET POSITION SENSITIVITY AND LONG TERM OFFSET DRIFT ERRORS.
- NOTE 3: SHIFT IS RELATIVE TO 25C.
- NOTE 4: SHIFT IS WITHIN THE FIRST HOUR OF EXCITATION APPLIED TO THE DEVICE.
- NOTE 5: PARAMETER IS CHARACTERIZED AND NOT 100% TESTED.
- NOTE 6: MEASURED AT ONE-HALF FULL SCALE RATED PRESSURE USING BEST STRAIGHT LINE CURVE FIT.
- NOTE 7: DATA UPDATE TIME IS EXCLUSIVE OF COMMUNICATIONS, FROM COMMAND RECEIVED TO END OF BUSY STATUS. THIS CAN BE OBSERVED AS EOC PIN LOW- STATE DURATION.
- NOTE 8: AVERAGE CURRENT CAN BE ESTIMATED AS:  $ICC_{idle} + (t_{DU} / \text{READING INTERVAL}) * ICC_{ACTIVE}$ . REFER TO FIGURE 2 FOR ACTIVE AND IDLE CONDITIONS OF THE SENSOR (THE ACTIVE STATE IS WHILE EOC PIN IS LOW).
- NOTE 9: THE SENSOR IS CALIBRATED WITH A 3.3V SUPPLY HOWEVER, AN INTERNAL REGULATOR ALLOWS A SUPPLY VOLTAGE OF 1.68V TO 3.6V TO BE USED WITHOUT AFFECTING THE OVERALL SPECIFICATIONS. THIS ALLOWS DIRECT OPERATION FROM A BATTERY SUPPLY.

## Device Ordering Options

### Output Resolution

Calibrated output resolution can be ordered to be 16, 17, or 18 bits.

Higher resolution results in slower update times; see the Data Update Time in the Performance Characteristics table.

### Coating

**Parylene Coating:** Parylene coating provides a moisture barrier and protection from some harsh media. Consult factory for applicability of Parylene for the target application and sensor type.

## Operation Overview

The DLH is a digital sensor with a signal path that includes a sensing element, a variable-bit analog to digital converter, a DSP and an IO block that supports either an I2C or SPI interface (see Figure 1 below). The sensor also includes an internal temperature reference and associated control logic to support the configured operating mode. Since there is a single ADC, there is also a multiplexer at the front end of the ADC that selects the signal source for the ADC.

Figure 1 - DLH Essential Model

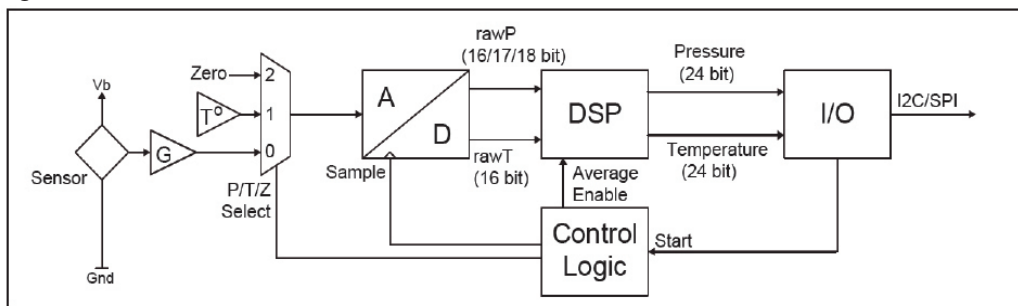

The ADC performs conversions on the raw sensor signal (P), the temperature reference (T) and a zero reference (Z) during the ADC measurement cycle.

The DSP receives the converted pressure and temperature information and applies a multi-order transfer function to compensate the pressure output. This transfer function includes compensation for span, offset, temperature effects on span, temperature effects on offset and second order temperature effects on both span and offset. There is also linearity compensation for gage devices and front to back linearity compensation for differential devices.

**Sensor Commands:** Five Measurement commands are supported, returning values of either a single pressure / temperature reading or an average of 2, 4, 8, or 16 readings. Each of these commands wakes the sensor from Idle state into Active state, and starts a measurement cycle. For the Start-Average commands, this cycle is repeated the appropriate number of times, while the Start-Single command performs a single iteration. When the DSP has completed calculations and the new values have been made available to the I/O block, the sensor returns to Idle state. The sensor remains in this low-power state until another Measurement command is received.

After completion of the measurement, the result may then be read using the Data Read command. The ADC and DSP remain in Idle state, and the I/O block returns the 7 bytes of status and measurement data. See Figure 2, following. At any time, the host may request current device status with the Status Read command. See Table 1 for a summary of all commands.

For optimum sensor performance, All Sensors recommends that Measurement commands be issued at a fixed interval by the host system. Irregular request intervals may increase overall noise on the output.

*Furthermore, if reading intervals are much slower than the Device Update Time, using the Averaging commands is suggested to reduce offset shift. This shift is constant with respect to time interval, and may be removed by the application. For longer fixed reading intervals, this shift may be removed by the factory on special request.*

**I/O Interface Configuration:** The sensor automatically selects SPI or I2C serial interface, based on the following protocol: If the  $/SS$  input is set low by the host (as occurs during a SPI command transaction), the I/O interface will remain configured for SPI communications until power is removed. Otherwise, once a valid device address and command have been received over the I2C interface, the I/O interface will remain configured for I2C until power is removed.

**NOTE:** The four-pin (SIP) packages only support the I2C interface.

## Operation Overview

Figure 2 - DLH Communication Model

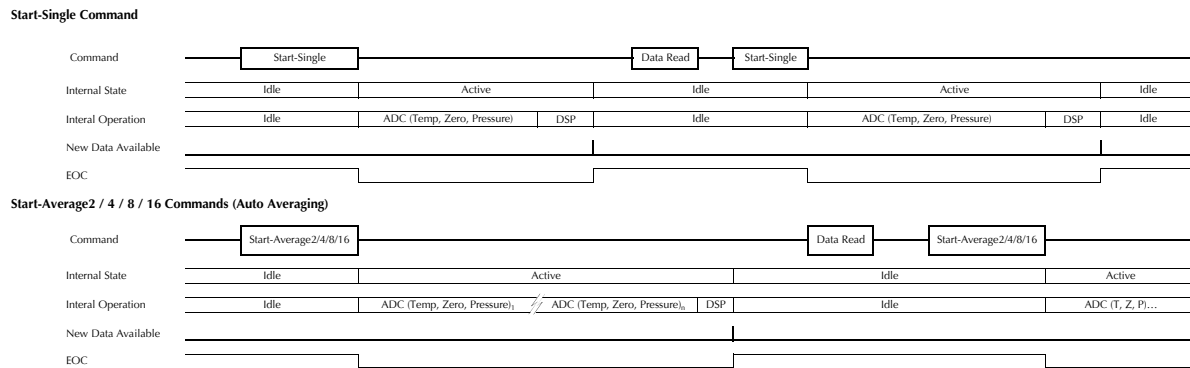

## Digital Interface Command Formats

When requesting the start of a measurement, the command length for I2C is 1 byte, for SPI it is 3 bytes.

When requesting sensor status over I2C, the host simply performs a 1-byte read transfer.

When requesting sensor status over SPI, the host **MUST** send the Status Read command byte while reading 1 byte.

When reading sensor data over I2C, the host simply performs a 7-byte read transfer.

When reading sensor data over SPI, the host **MUST** send the 7-byte Data Read command while reading the data.

**SENDING UNDOCUMENTED COMMANDS TO SENSOR WILL CORRUPT CALIBRATION AND IS NOT COVERED BY WARRANTY.**

See Table 1 below for Measurement Commands, Sensor Data read and Sensor Status read details.

Table 1 - DLH Sensor Command Set

Measurement Commands				
Description	SPI ( 3 bytes )			I2C ( 1 byte)
Start-Single	0xAA	0x00	0x00	0xAA
Start-Average2	0xAC	0x00	0x00	0xAC
Start-Average4	0xAD	0x00	0x00	0xAD
Start-Average8	0xAE	0x00	0x00	0xAE
Start-Average16	0xAF	0x00	0x00	0xAF

Read Sensor Data	
I2C	Read of 7 bytes from device
SPI	Read of 7 bytes from device <b>Host must send [0xF0], then 6 bytes of [0x00] on MOSI</b> Sensor Returns 7 bytes on MISO

Read Sensor Status	
I2C	Read of 1 byte from device.
SPI	Read of 1 byte from device <b>Host must send [0xF0] on MOSI</b> Sensor Returns 1 byte on MISO

## Digital Interface Data Format

For either type of digital interface, the format of data returned from the sensor is the same. The first byte consists of the Status Byte followed by a 24-bit unsigned pressure value and a 24-bit unsigned temperature value. Unused bits beyond the calibrated bit width are undefined, and may have any value. See the Pressure Output Transfer Function and Temperature Output Transfer Function definitions on page 3 for converting to pressure and temperature. Refer to Table 2 for the overall data format of the sensor. Table 3 shows the Status Byte definition. Note that a completed reading without error will return status 0x40.

Table 2 - Output Data Format

S[7:0]	P[23:16]	P[15:8]	P[7:0]	T[23:16]	T[15:8]	T[7:0]
Status Byte	Pressure Byte 3	Pressure Byte 1	Pressure Byte 0	Temperature Byte 3	Temperature Byte 1	Temperature Byte 0

Table 3- Status Byte Definition

Bit	Description
Bit 7 [MSB]	[Always = 0]
6	Power : [1 = Power On]
5	Busy: [ 1 = Processing Command, 0 = Ready]
4:3	Mode: [00 = Normal Operation ]
2	Memory Error [ 1 = EEPROM Checksum Fail]
1	Sensor Configuration [ always = 0]
Bit 0 [LSB]	ALU Error [1 = Error]

## I2C Interface

### I2C Command Sequence

The part enters Idle state after power-up, and waits for a command from the bus master. Any of the five Measurement commands may be sent, as shown in Table 1. Following receipt of one of these command bytes, the EOC pin is set to Low level, and the sensor Busy bit is set in the Status Byte. After completion of measurement and calculation in the Active state, compensated data is written to the output registers, the EOC pin is set high, and the processing core goes back to Idle state. The host processor can then perform the Data Read operation, which for I2C is simply a 7-byte Device Read.

If the EOC pin is not monitored, the host can poll the Status Byte by repeating the Status Read command, which for I2C is a one-byte Device Read. When the Busy bit in the Status byte is zero, this indicate that valid data is ready, and a full Data Read of all 7 bytes may be performed.

**DO NOT SEND COMMANDS TO SENSOR OTHER THAN THOSE DEFINED IN TABLE 1.**

## I2C Interface (Cont'd)

### I2C Bus Communications Overview

The I2C interface uses a set of signal sequences for communication. The following is a description of the supported sequences and their associated mnemonics. Refer to Figure 3 for the associated usage of the following signal sequences.

**Bus not Busy (I):** During idle periods both data line (SDA) and clock line (SCL) remain HIGH.

**START condition (ST):** A HIGH to LOW transition of SDA line while the clock (SCL) is HIGH is interpreted as START condition. START conditions are always set by the master. Each initial request for a pressure value has to begin with a START condition.

**Slave address (An):** The I<sup>2</sup>C-bus requires a unique address for each device. The DLH sensor has a preconfigured slave address (see specification table on Page 3). After setting a START condition the master sends the address byte containing the 7 bit sensor address followed by a data direction bit (R/W). A "0" indicates a transmission from master to slave (WRITE), a "1" indicates a device-to master request (READ).

**Acknowledge (A or N):** Data is transferred in units of 8 bits (1 byte) at a time, MSB first. Each data-receiving device, whether master or slave, is required to pull the data line LOW to acknowledge receipt of the data. The Master must generate an extra clock pulse for this purpose. If the receiver does not pull the data line down, a NACK condition exists, and the slave transmitter becomes inactive. The master determines whether to send the last command again or to set the STOP condition, ending the transfer.

**DATA valid (Dn):** State of data line represents valid data when, after a START condition, data line is stable for duration of HIGH period of clock signal. Data on line must be changed during LOW period of clock signal. There is one clock pulse per data bit.

**STOP condition (P):** LOW to HIGH transition of the SDA line while clock (SCL) is HIGH indicates a STOP condition. STOP conditions are always generated by the master.

Figure 3 - I2C Communication Diagram

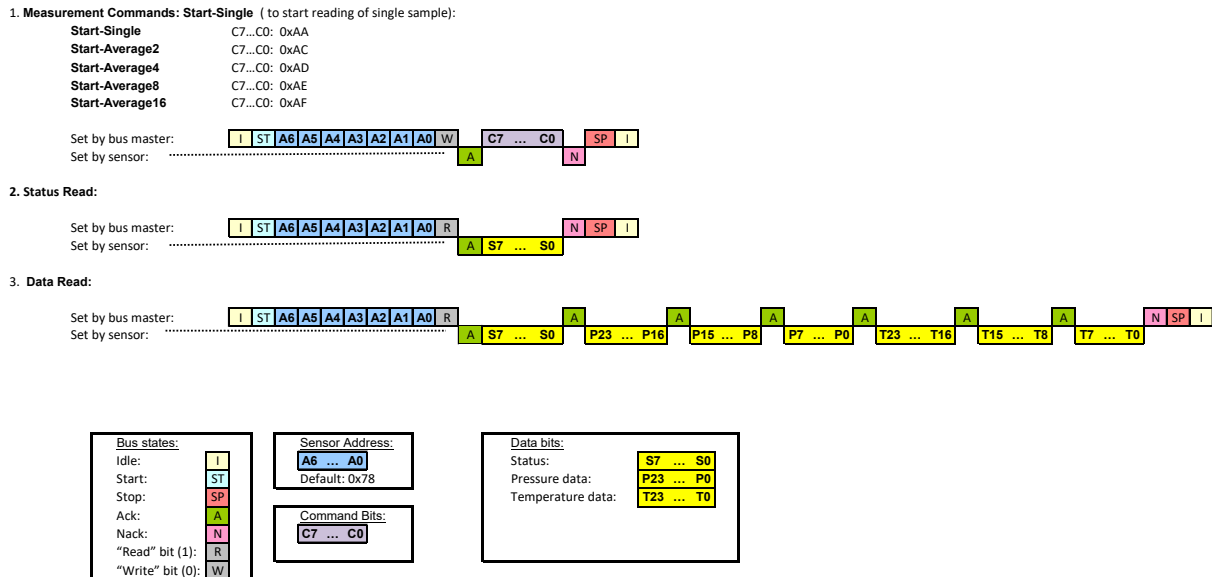



## SPI Interface

### SPI Command Sequence

As with the I2C interface configuration, the part enters Idle state after power-up, and waits for a command from the SPI master. To start a measurement cycle, one of the 3- byte Measurement Commands (see Table 1) must be issued by the master. The data returned by the sensor during this command request consists of the Status Byte followed by two undefined data bytes. On successful decode of the command, the EOC pin is set Low as the core goes into Active state for measurement and calculation. When complete, updated sensor data is written to the output registers, and the core goes back to the Idle state. The EOC pin is set to a High level at this point, and the Busy status bit is set to 0. At any point during the Active or Idle periods, the SPI master can request the Status Byte by sending a Status Read command (a single byte with value 0xF0).

As with the I2C configuration, a Busy bit of value 0 in the Status Byte or a high level on the EOC pin indicates that a valid data set may be read from the sensor. The Data Read command must be sent from the SPI master (The first byte of value 0xF0 followed by 6 bytes of 0x00).

**NOTE: Sending commands that are not defined in Table 1 will corrupt sensor operation.**

### SPI Bus Communications Overview

The sequence of bits and bus signals are shown in the following illustration (Figure 4). Refer to Figure 5 in the Interface Timing Diagram section for detailed timing data.

Figure 4 - SPI Communications Diagram

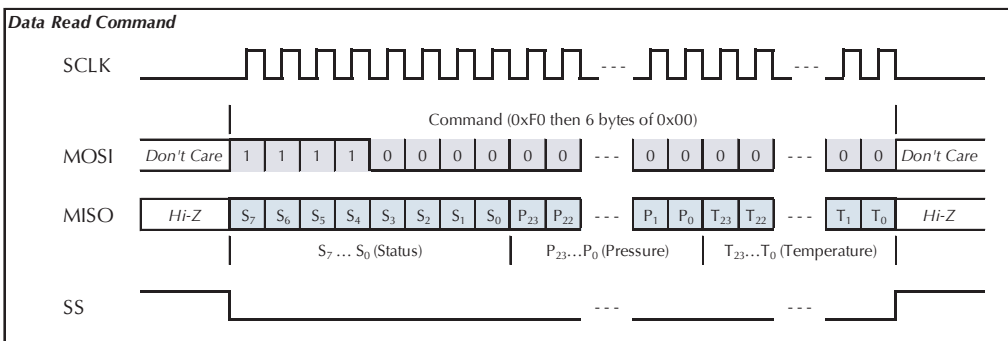
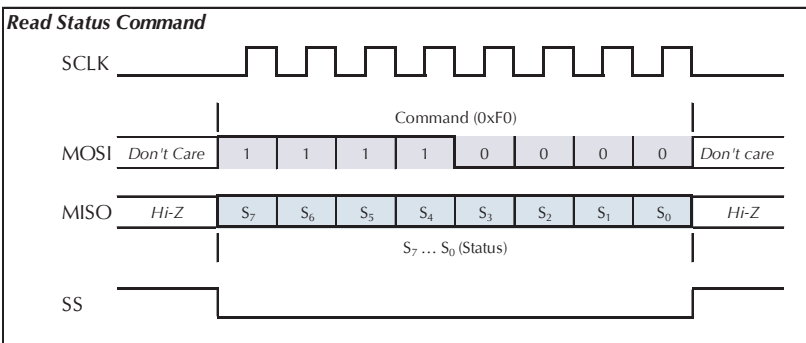
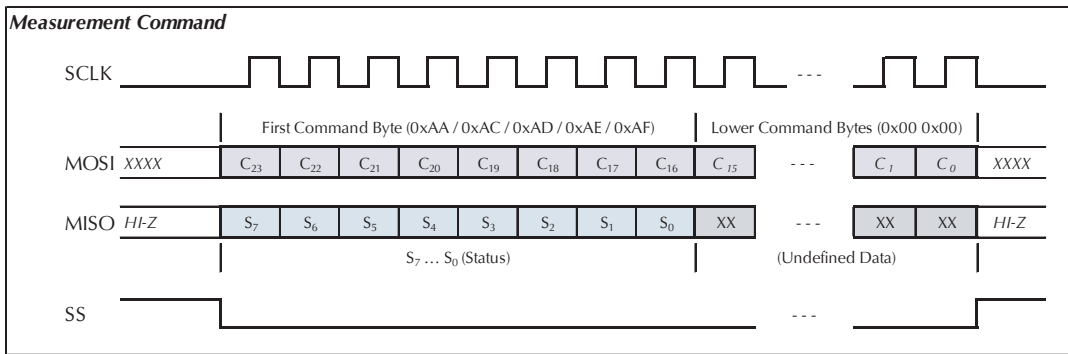



## Interface Timing Diagrams

Figure 5 - SPI Timing Diagram

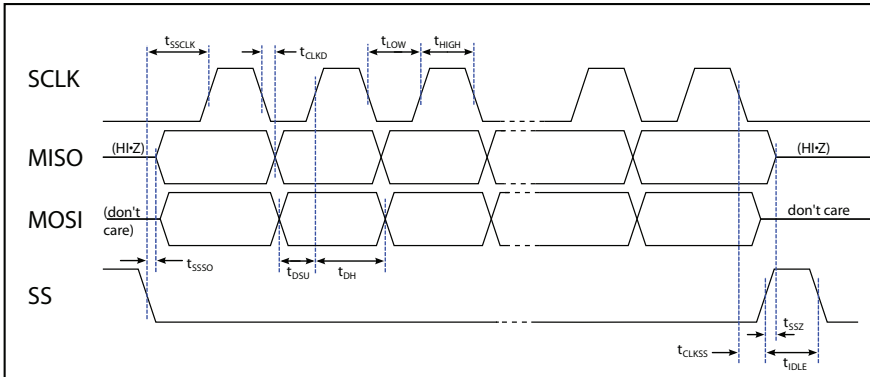

PARAMETER	SYMBOL	MIN	TYP	MAX	UNITS
SCLK frequency <sup>(1)</sup>	f <sub>SCLK</sub>	0.05	-	5	MHz
SS low to first clock edge	t <sub>SSCLK</sub>	120	-	-	ns
SS low to serial out	t <sub>SSSO</sub>	--	-	20	ns
Clock to data out	t <sub>CLKD</sub>	8	-	32	ns
SCLK low width	t <sub>LOW</sub>	100	-	-	ns
SCLK high width	t <sub>HIGH</sub>	100	-	-	ns
Data setup to clock	t <sub>DSU</sub>	50	-	-	ns
Data hold after clock	t <sub>DH</sub>	50	-	-	ns
Last clock to rising SS	t <sub>CLKSS</sub>	0	-	-	ns
SS high to output hi-Z	t <sub>SSZ</sub>	--	-	20	ns
Bus idle time	t <sub>IDLE</sub>	250	-	-	ns

(1) Maximum by design, tested to 1.0 MHz.

Figure 6 - I2C Timing Diagram

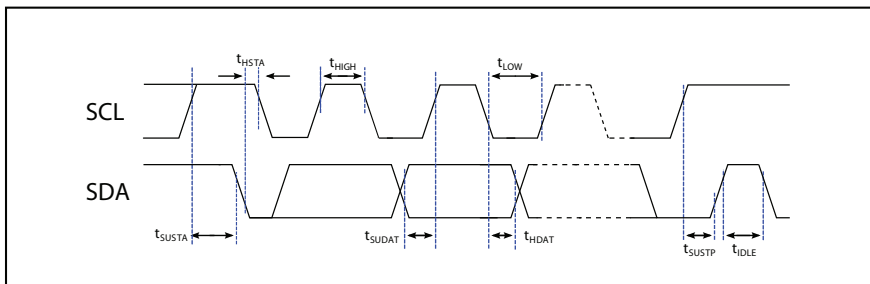

PARAMETER	SYMBOL	MIN	TYP	MAX	UNITS
SCL frequency	f <sub>SCL</sub>	100	-	400	KHz
SCL low width	t <sub>LOW</sub>	1.3	-	-	µs
SCL high width	t <sub>HIGH</sub>	0.6	-	-	µs
Start condition setup	t <sub>SUSTA</sub>	0.6	-	-	µs
Start condition hold	t <sub>HSTA</sub>	0.6	-	-	µs
Data setup to clock	t <sub>SUDAT</sub>	0.1	-	-	µs
Data hold to clock	t <sub>HDAT</sub>	0	-	-	µs
Stop condition setup	t <sub>SUSTP</sub>	0.6	-	-	µs
Bus idle time	t <sub>IDLE</sub>	2.0	-	-	µs

## How to Order

Refer to Table 4 for configuring a standard base part number which includes the pressure range, package and temperature range. Table 5 shows the available configuring options. The option identifier is required to complete the device part number. Refer to Table 6 for the available device packages.

Example P/N with options: DLH-L05D-E1NS-C-NAV6

Table 4 - How to configure a base part







ORDERING INFORMATION	SERIES		PRESSURE RANGE		PACKAGE						TEMPERATURE RANGE				
	ID		ID	Description	Base		Port Orientation		Lid Style		Lead Type		ID	Description	
	DLH		L05D	±5 inH2O	ID	Description	ID	Description	ID	Description	ID	Description	C	Commercial	
			L10D	±10 inH2O	E	1	Dual Port Same Side	N	Non-Barbed	S	SIP	I	Industrial		
			L20D	±20 inH2O		2	Dual Port Opposite Side	B	Barbed	D	DIP				
			L30D	±30 inH2O						J	J-Lead SMT				
			L60D	±60 inH2O											
			L05G	0 to 5 inH2O											
			L10G	0 to 10 inH2O											
			L20G	0 to 20 inH2O											
			L30G	0 to 30 inH2O											
			L60G	0 to 60 inH2O											
Example	DLH	-	L05D		E	1		N		S		-	C		

Table 5 - How to configure an option identifier

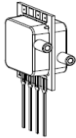
ORDERING INFORMATION	COATING		INTERFACE		SUPPLY VOLTAGE		RESOLUTION	
	ID	Description	ID	Description	ID	Description	ID	Description
	N	No Coating	A	Auto I2C/SPI	V	1.68V to 3.6V	6	16 Bit
P	Parylene Coating <sup>(1)</sup>					7	17 bit	
						8	18 bit	
Example	N		A		V		6	

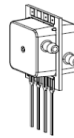
(1) Parylene coating not offered on J-Lead Configurations

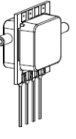
Table 6 - Available E-Series Package Configurations

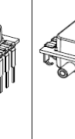
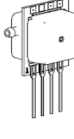
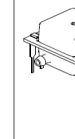
Port Orientation	Non-Barbed Lid Lead Style				Barbed Lid Lead Style			
	SIP <sup>(1)</sup>	DIP	J Lead SMT	Low Profile DIP	SIP <sup>(1)</sup>	DIP	J Lead SMT	Low Profile DIP
Dual Port Same Side	 E1NS	 E1ND	 E1NJ	N/A	 E1BS	 E1BD	N/A	N/A
Dual Port Opposite Side	 E2NS	 E2ND	 E2NJ	N/A	 E2BS	 E2BD	N/A	N/A
Single Port (Gage)	N/A	N/A	N/A	N/A	N/A	N/A	N/A	N/A

(1) SPI is not available in SIP packages

## Package Drawings

### E1NS Package

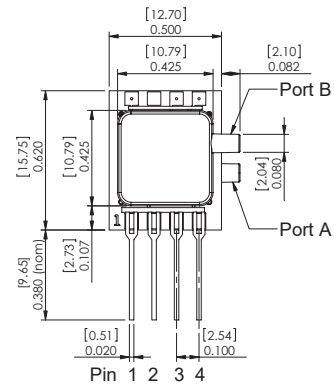
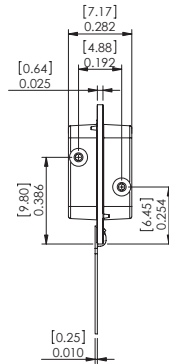
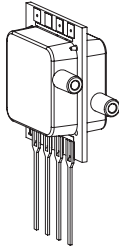

#### Pinout

- 1) Gnd
- 2) Vs
- 3) SDA
- 4) SCL

#### NOTES

- 1) Dimensions are in inches [mm]
- 2) For suggested pad layout, see drawing: PAD-01

### E1BS Package

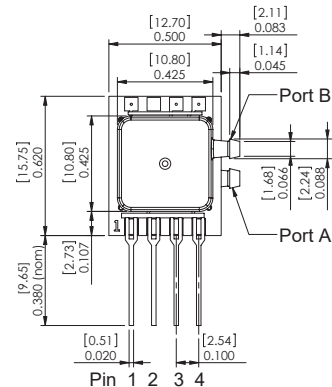
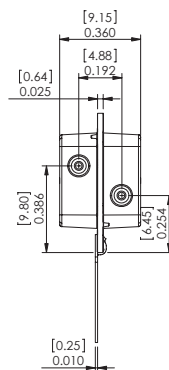
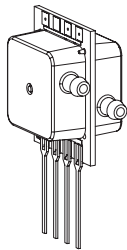

#### Pinout

- 1) Gnd
- 2) Vs
- 3) SDA
- 4) SCL

#### NOTES

- 1) Dimensions are in inches [mm]
- 2) For suggested pad layout, see drawing: PAD-01

Package Drawings (Cont'd)

E2NS Package

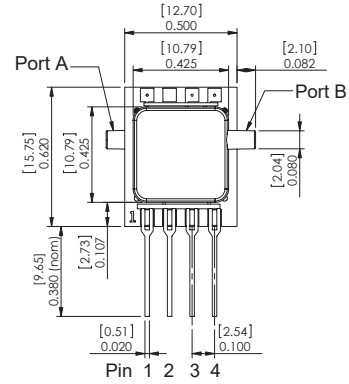
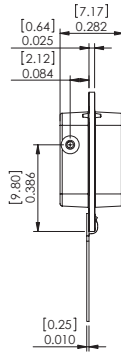
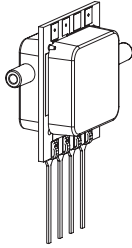

- Pinout**  
 1) Gnd  
 2) Vs  
 3) SDA  
 4) SCL

NOTES

- 1) Dimensions are in inches [mm]
- 2) For suggested pad layout, see drawing: PAD-01

E2BS Package

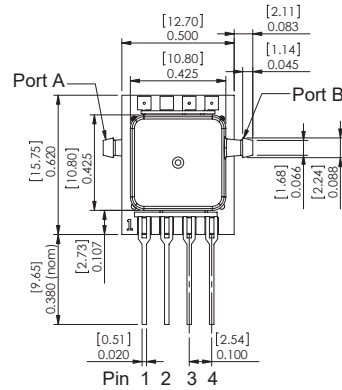
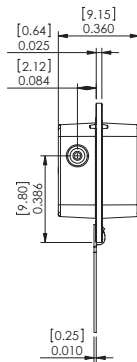
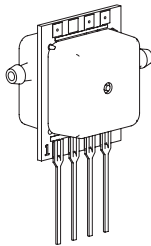

- Pinout**  
 1) Gnd  
 2) Vs  
 3) SDA  
 4) SCL

NOTES

- 1) Dimensions are in inches [mm]
- 2) For suggested pad layout, see drawing: PAD-01

Package Drawings (Cont'd)

E1ND Package

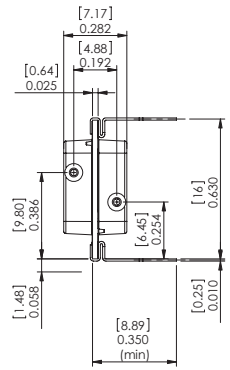
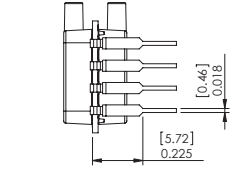
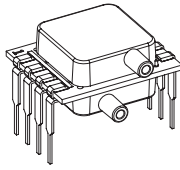

- Pinout**
- 1) Gnd
  - 2) Vs
  - 3) SDA/MOSI
  - 4) SCL/SCLK
  - 5) EOC
  - 6) MISO
  - 7) Not Connected
  - 8) /SS

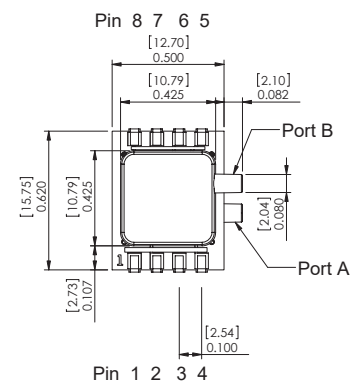

- NOTES**
- 1) Dimensions are in inches [mm]
  - 2) For suggested pad layout, see drawing: PAD-03

E1BD Package

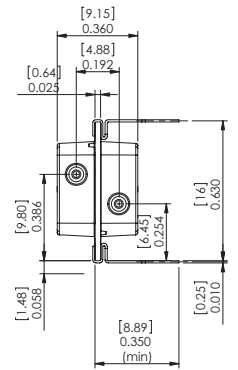
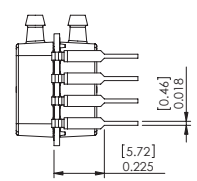
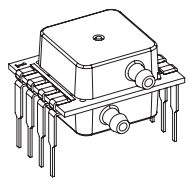

- Pinout**
- 1) Gnd
  - 2) Vs
  - 3) SDA/MOSI
  - 4) SCL/SCLK
  - 5) EOC
  - 6) MISO
  - 7) Not Connected
  - 8) /SS

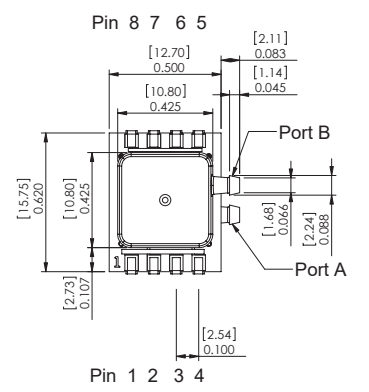

- NOTES**
- 1) Dimensions are in inches [mm]
  - 2) For suggested pad layout, see drawing: PAD-03

Package Drawings (Cont'd)

E2ND Package

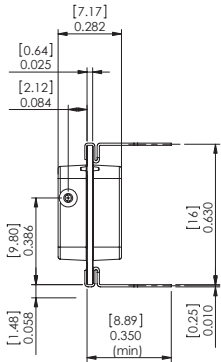
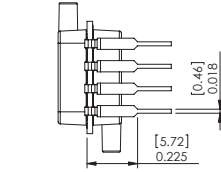
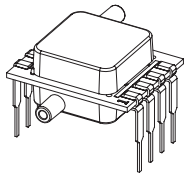

**Pinout**

- 1) Gnd
- 2) Vs
- 3) SDA/MOSI
- 4) SCL/SCLK
- 5) EOC
- 6) MISO
- 7) Not Connected
- 8) /SS

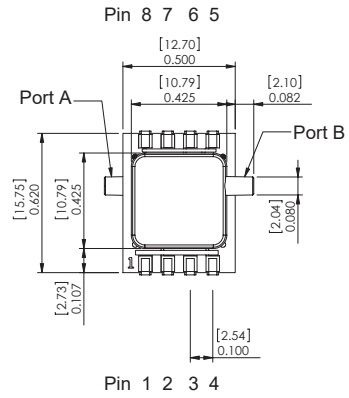

**NOTES**

- 1) Dimensions are in inches [mm]
- 2) For suggested pad layout, see drawing: PAD-03

E2BD Package

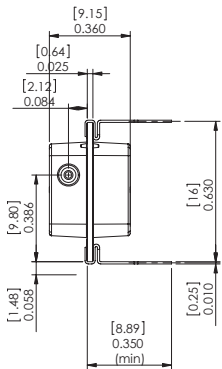
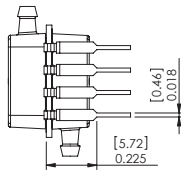
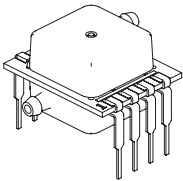

**Pinout**

- 1) Gnd
- 2) Vs
- 3) SDA/MOSI
- 4) SCL/SCLK
- 5) EOC
- 6) MISO
- 7) Not Connected
- 8) /SS

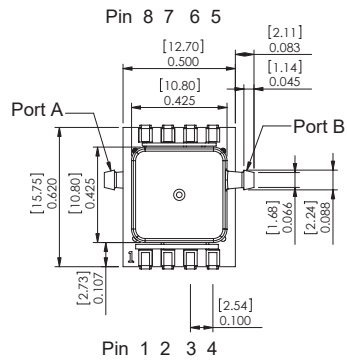

**NOTES**

- 1) Dimensions are in inches [mm]
- 2) For suggested pad layout, see drawing: PAD-03

Package Drawings (Cont'd)

E1NJ Package

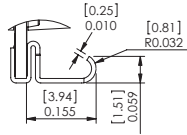
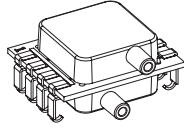

DETAIL A  
SCALE 4 : 1

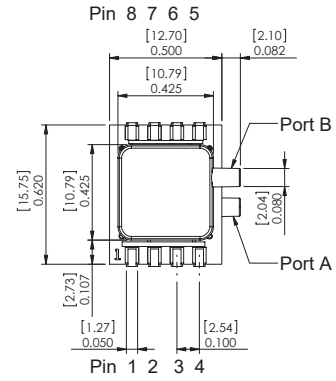
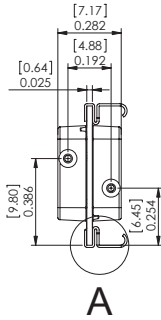

Pinout

- 1) Gnd
- 2) Vs
- 3) SDA/MOSI
- 4) SCL/SCLK
- 5) EOC
- 6) MISO
- 7) Not Connected
- 8) /SS

NOTES

- 1) Dimensions are in inches [mm]
- 2) For suggested pad layout, see drawing: PAD-10

E2NJ Package

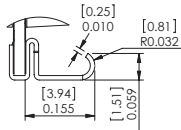
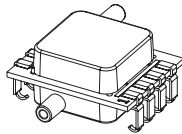

DETAIL A  
SCALE 4 : 1

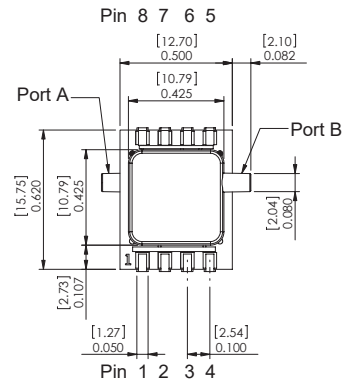
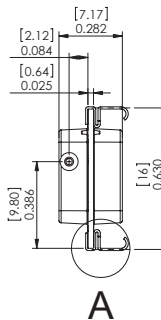

Pinout

- 1) Gnd
- 2) Vs
- 3) SDA/MOSI
- 4) SCL/SCLK
- 5) EOC
- 6) MISO
- 7) Not Connected
- 8) /SS

NOTES

- 1) Dimensions are in inches [mm]
- 2) For suggested pad layout, see drawing: PAD-10



### Suggested Pad Layout

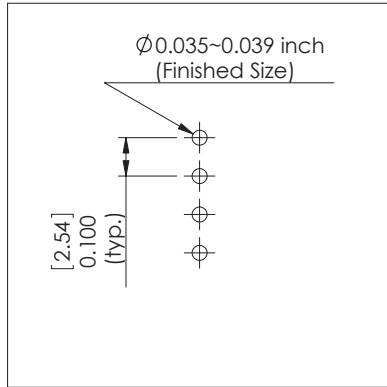

PAD-01

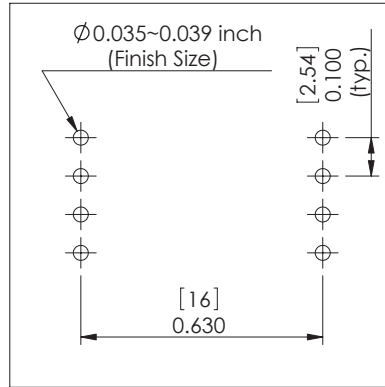

PAD-03

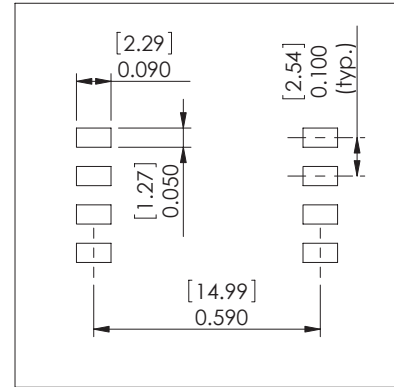

PAD-10

### Product Labeling

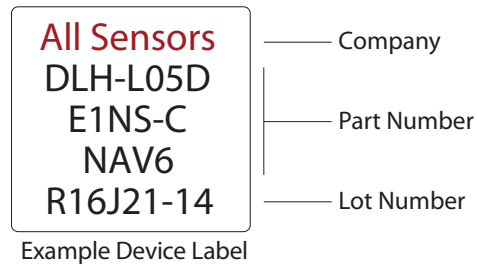

All Sensors reserves the right to make changes to any products herein. All Sensors does not assume any liability arising out of the application or use of any product or circuit described herein, neither does it convey any license under its patent rights nor the rights of others.