

Chip Inductor ASCQ Series

**Automotive
AEC-Q200**

RoHS Compliant
Halogen Free
REACH Compliant



Noise
Suppression

Shield

Multilayer

Ceramic

High
Frequency

Part Numbering

A	SCQ	00	060303	1N0	B	00
Grade	Series Name	Control Code	Dimensions Code (mm)	Inductance (nH)	Tolerance	Internal Code
			060303 0.6x0.3x0.3	0N6 0.6 1N0 1.0 10N 10	B ±0.1nH C ±0.2nH H ±3%	

This specification applies to Multilayer Chip Inductors for Automotive Electronics based on AEC-Q200 except for Power train and Safety.

ASCQ00060303 Type

■ Dimensions

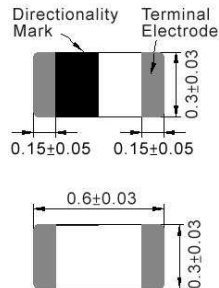

unit:mm

■ Recommended Land Pattern

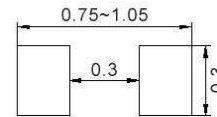

unit:mm

■ Electrical Characteristics

Part No.	Inductance	L,Q	Q	SRF	RDC	IDC	Tolerance
	(nH)	Test Freq.	Min.	(MHz)Min.	(Ω)Max.	(mA)Max.	(±%)
ASCQ000603030N6□00	0.6	500 MHz,500 mV	14	10000	0.06	900	B
ASCQ000603030N7□00	0.7	500 MHz,500 mV	14	10000	0.06	900	B
ASCQ000603030N8□00	0.8	500 MHz,500 mV	14	10000	0.06	900	B
ASCQ000603030N9□00	0.9	500 MHz,500 mV	14	10000	0.06	900	B
ASCQ000603031N0□00	1.0	500 MHz,500 mV	14	10000	0.07	850	B
ASCQ000603031N1□00	1.1	500 MHz,500 mV	14	10000	0.07	850	B
ASCQ000603031N2□00	1.20	500 MHz,500 mV	14	10000	0.08	800	B
ASCQ000603031N3□00	1.30	500 MHz,500 mV	14	10000	0.09	760	B
ASCQ000603031N4□00	1.40	500 MHz,500 mV	14	10000	0.12	640	B
ASCQ000603031N5□00	1.50	500 MHz,500 mV	14	10000	0.15	600	B
ASCQ000603031N6□00	1.60	500 MHz,500 mV	14	10000	0.19	510	B
ASCQ000603031N7□00	1.70	500 MHz,500 mV	14	10000	0.11	680	B
ASCQ000603031N8□00	1.80	500 MHz,500 mV	14	10000	0.12	640	B
ASCQ000603031N9□00	1.90	500 MHz,500 mV	14	10000	0.13	620	B
ASCQ000603032N0□00	2.00	500 MHz,500 mV	14	10000	0.15	600	B
ASCQ000603032N1□00	2.10	500 MHz,500 mV	14	10000	0.16	550	B
ASCQ000603032N2□00	2.20	500 MHz,500 mV	14	10000	0.20	500	B
ASCQ000603032N3□00	2.30	500 MHz,500 mV	14	10000	0.24	460	B
ASCQ000603032N4□00	2.4	500 MHz,500 mV	14	10000	0.26	430	B
ASCQ000603032N5□00	2.5	500 MHz,500 mV	14	10000	0.28	415	B
ASCQ000603032N6□00	2.6	500 MHz,500 mV	14	10000	0.30	405	B
ASCQ000603032N7□00	2.7	500 MHz,500 mV	14	10000	0.32	400	B
ASCQ000603032N8□00	2.8	500 MHz,500 mV	14	9500	0.20	500	B
ASCQ000603032N9□00	2.9	500 MHz,500 mV	14	9300	0.22	480	B
ASCQ000603033N0□00	3	500 MHz,500 mV	14	9100	0.24	460	B
ASCQ000603033N1□00	3.1	500 MHz,500 mV	14	8900	0.25	450	B
ASCQ000603033N2□00	3.2	500 MHz,500 mV	14	8700	0.28	415	B
ASCQ000603033N3□00	3.3	500 MHz,500 mV	14	8600	0.28	415	B
ASCQ000603033N4□00	3.4	500 MHz,500 mV	14	8400	0.29	410	B
ASCQ000603033N5□00	3.5	500 MHz,500 mV	14	8200	0.30	405	B
ASCQ000603033N6□00	3.6	500 MHz,500 mV	14	8100	0.32	400	B
ASCQ000603033N7□00	3.7	500 MHz,500 mV	14	8000	0.36	370	B

Note: When ordering, please specify tolerance code. Tolerance: B=±0.1nH / C=±0.2nH / H=±3%

1. Operating temperature range - 55°C ~ 125°C
2. Applied the current to coils, the inductance shall be less than 10% initial value
3. Measure Equipment:
L & Q: Agilent E4991A+Agilent 16197A
SRF: Agilent E4991A or HP19196C
RDC: HP4338B or CHEN HWA 502

ASCQ00060303 Type

■ Dimensions

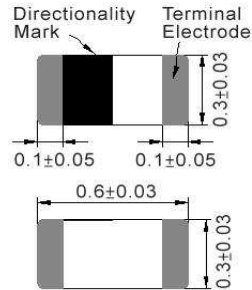

unit:mm

■ Recommended Land Pattern

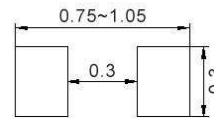

unit:mm

■ Electrical Characteristics

Part No.	Inductance	L,Q	Q	SRF	RDC	IDC	Tolerance
	(nH)	Test Freq.	Min.	(MHz)Min.	(Ω)Max.	(mA)Max.	(±%)
ASCQ000603033N8□00	3.8	500 MHz,500 mV	14	7800	0.40	355	B
ASCQ000603033N9□00	3.9	500 MHz,500 mV	14	7700	0.41	350	B
ASCQ000603034N3□00	4.3	500 MHz,500 mV	14	6500	0.48	320	C
ASCQ000603034N7□00	4.7	500 MHz,500 mV	14	6400	0.42	350	C
ASCQ000603035N1□00	5.1	500 MHz,500 mV	14	6100	0.45	330	C
ASCQ000603035N6□00	5.6	500 MHz,500 mV	14	5500	0.47	325	C
ASCQ000603036N2□00	6.2	500 MHz,500 mV	14	5100	0.52	305	C
ASCQ000603036N8□00	6.8	500 MHz,500 mV	14	4800	0.55	305	H
ASCQ000603037N5□00	7.5	500 MHz,500 mV	14	4600	0.55	305	H
ASCQ000603038N2□00	8.2	500 MHz,500 mV	14	4300	0.57	290	H
ASCQ000603039N1□00	9.1	500 MHz,500 mV	14	4000	0.65	270	H
ASCQ0006030310N□00	10	500 MHz,500 mV	14	3800	0.85	230	H
ASCQ0006030312N□00	12	500 MHz,500 mV	14	3300	0.85	230	H
ASCQ0006030315N□00	15	500 MHz,500 mV	14	2600	0.89	220	H
ASCQ0006030318N□00	18	500 MHz,500 mV	14	2300	1.05	205	H
ASCQ0006030322N□00	22	500 MHz,500 mV	14	1900	1.29	190	H

Note: When ordering, please specify tolerance code. Tolerance: B=±0.1nH / C=±0.2nH / H=±3%

1. Operating temperature range - 55°C ~ 125°C
2. Applied the current to coils, the inductance shall be less than 10% initial value
3. Measure Equipment:
L & Q: Agilent E4991A+Agilent 16197A
SRF: Agilent E4991A or HP19196C
RDC: HP4338B or CHEN HWA 502

ASCQ00060303 Type

Characteristics Graph

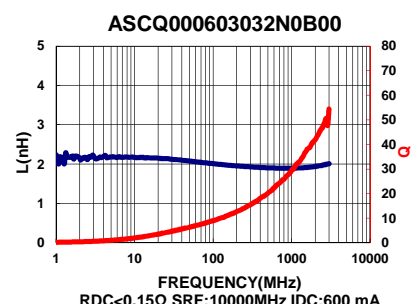
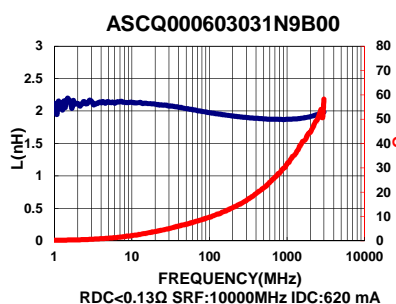
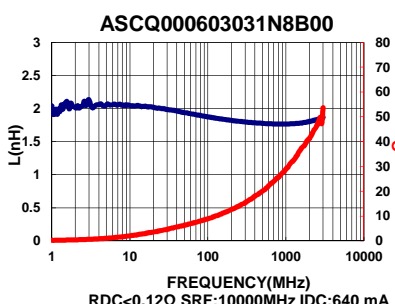
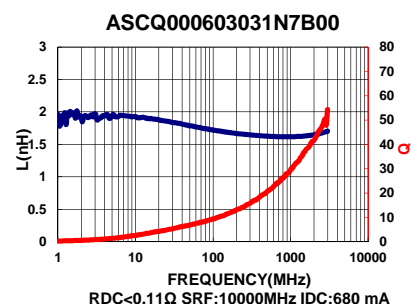
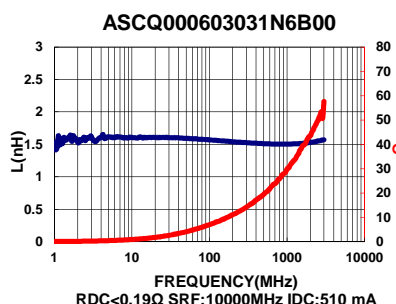
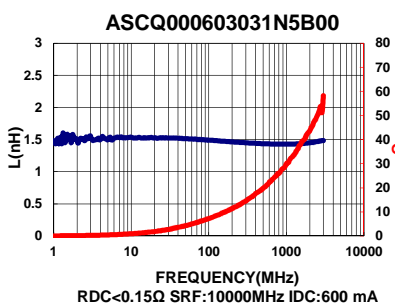
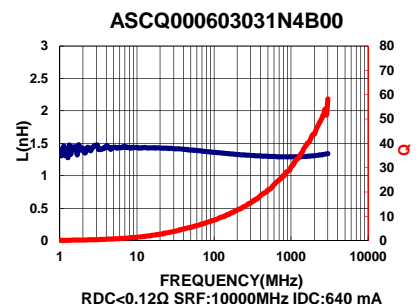
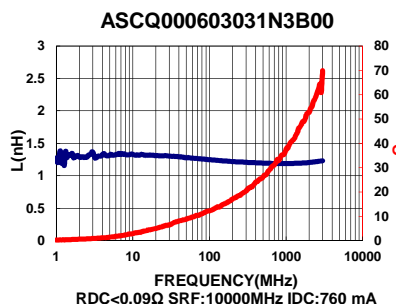
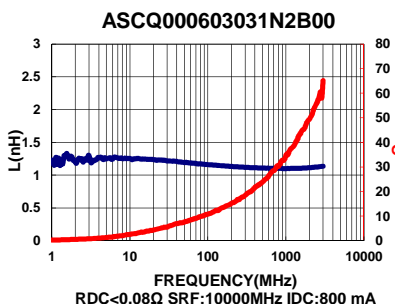
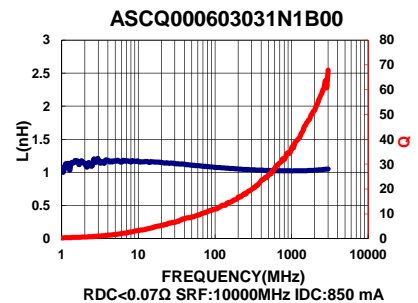
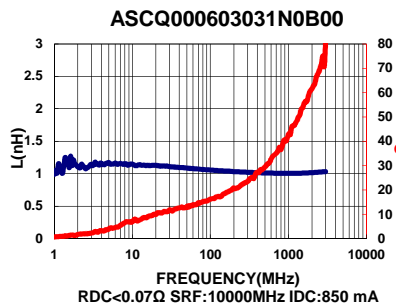
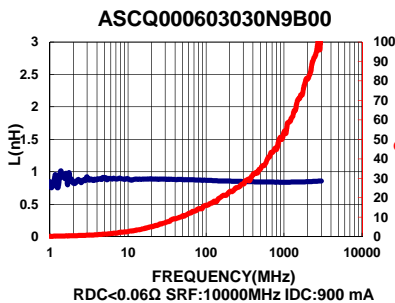
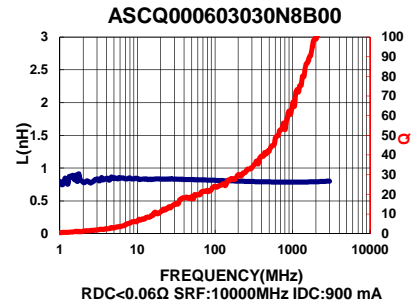
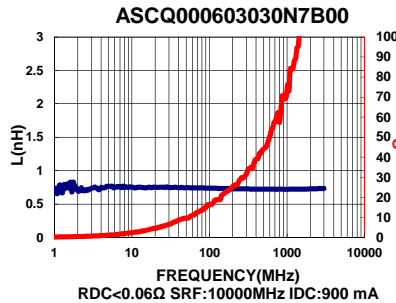
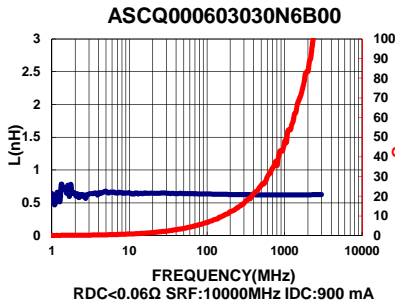

Please be sure to request approval specifications that provide further details of the products. Kindly note that the content of these specifications are subject to change or may be discontinued without prior notice. This product may not be designed/used in medical or high risk applications without Chilisin approval. Please contact our sales department before ordering.

ASCQ00060303 Type

Characteristics Graph

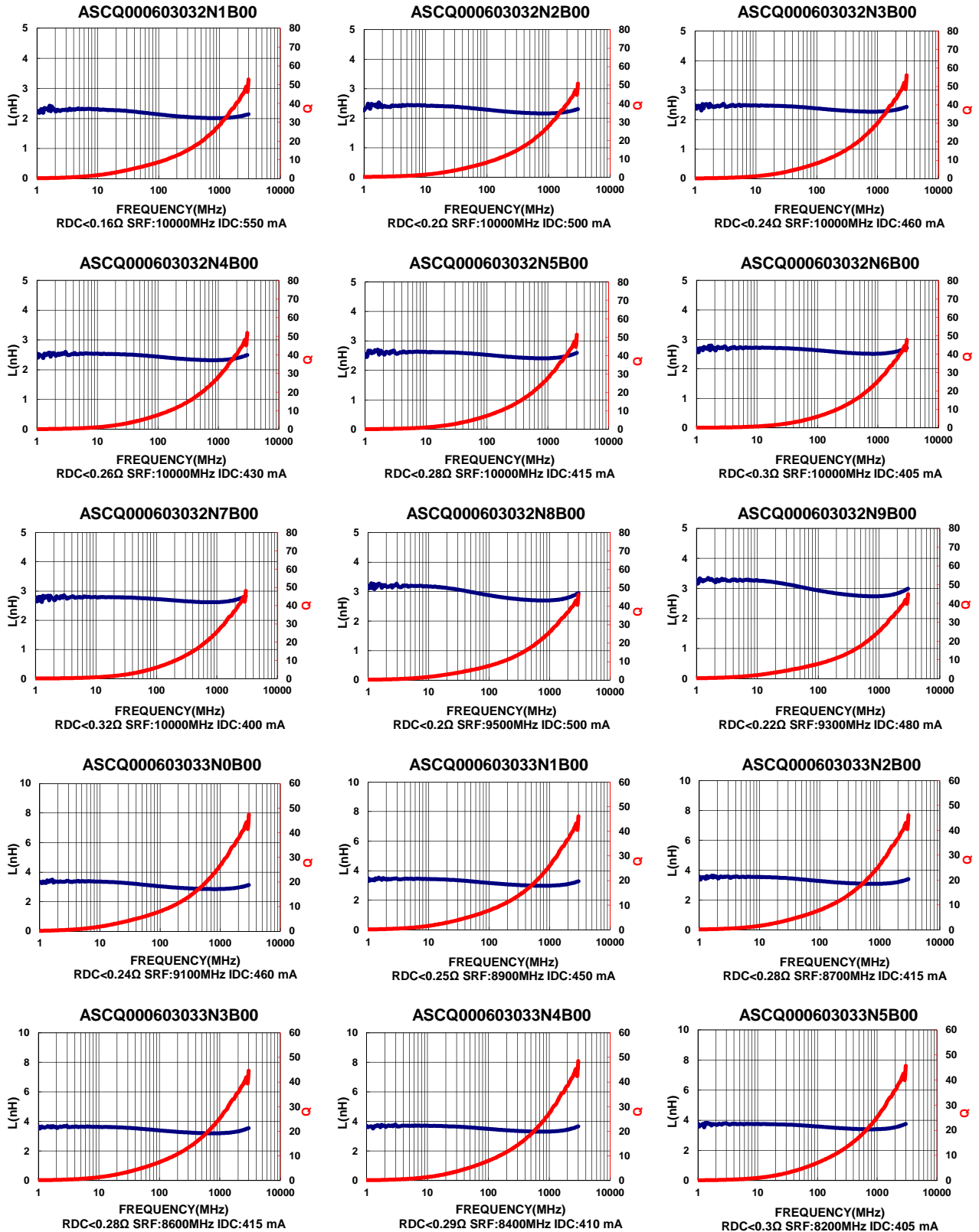

Please be sure to request approval specifications that provide further details of the products. Kindly note that the content of these specifications are subject to change or may be discontinued without prior notice. This product may not be designed/used in medical or high risk applications without Chilisin approval. Please contact our sales department before ordering.

ASCQ00060303 Type

Characteristics Graph

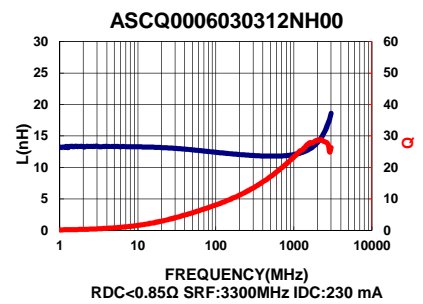
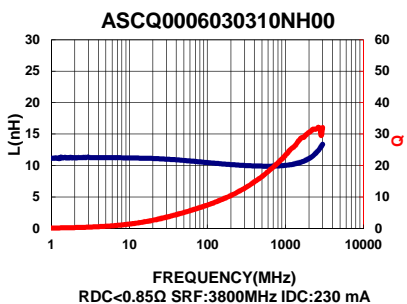
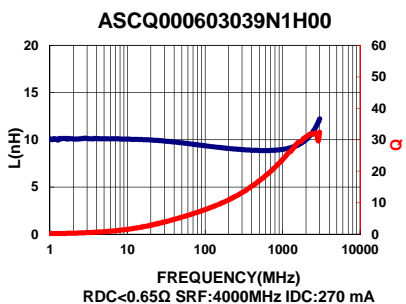
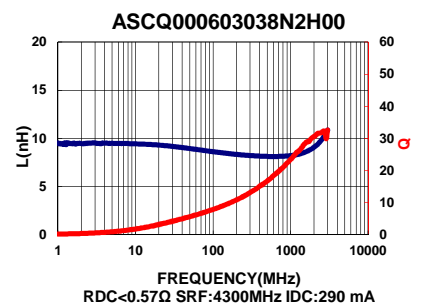
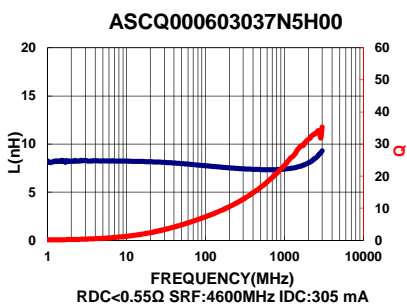
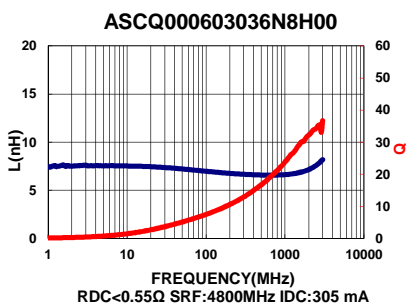
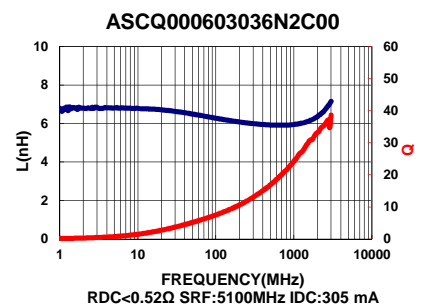
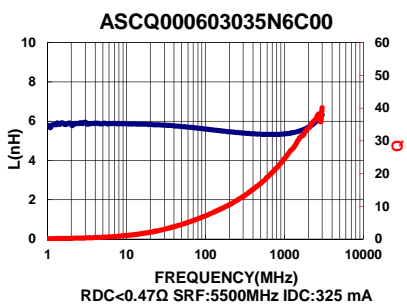
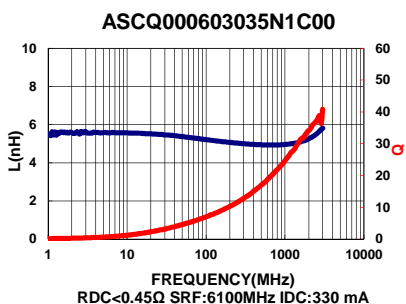
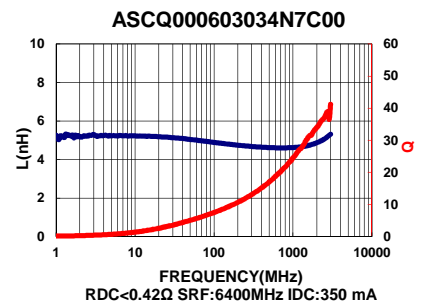
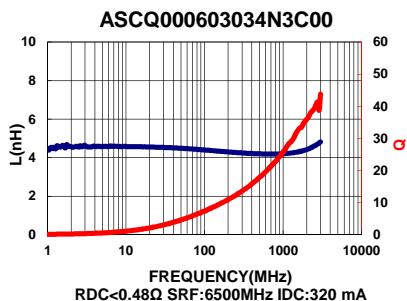
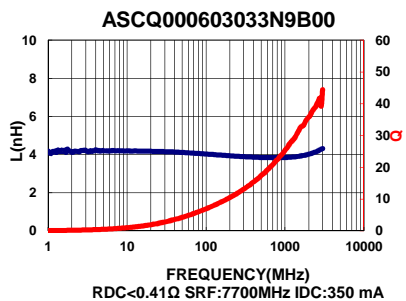
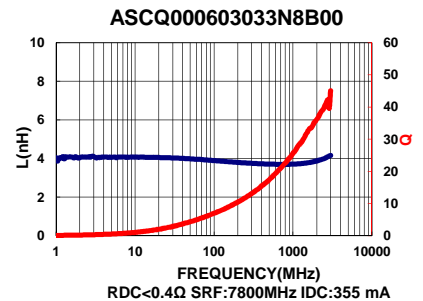
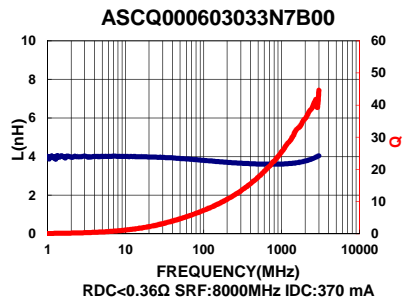
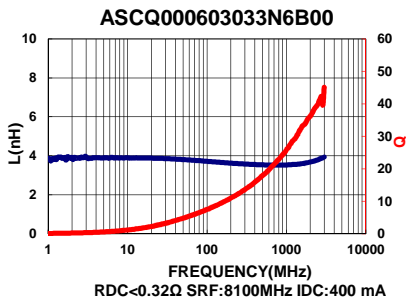

Please be sure to request approval specifications that provide further details of the products. Kindly note that the content of these specifications are subject to change or may be discontinued without prior notice. This product may not be designed/used in medical or high risk applications without Chilisin approval. Please contact our sales department before ordering.

ASCQ00060303 Type

■ Characteristics Graph

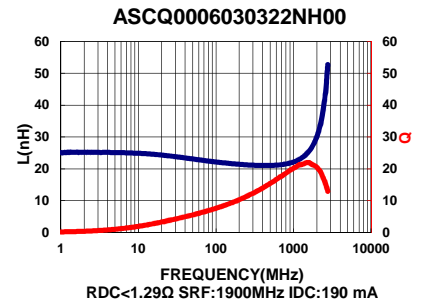
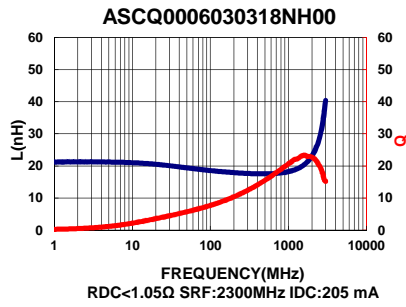
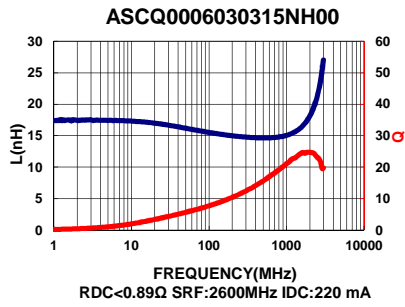

■ Packaging

Tape Dimensions

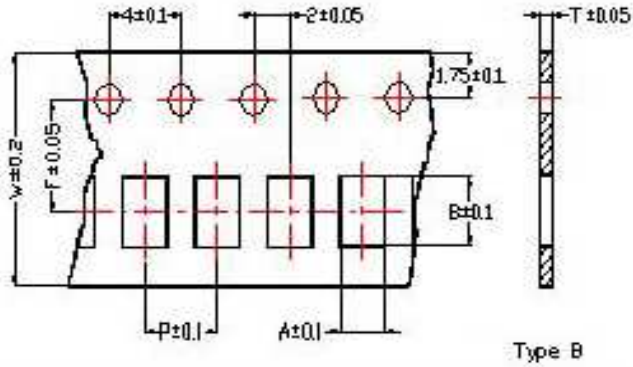

Tape Material

Carrier tape : Paper
Cover tape : Polyethylene

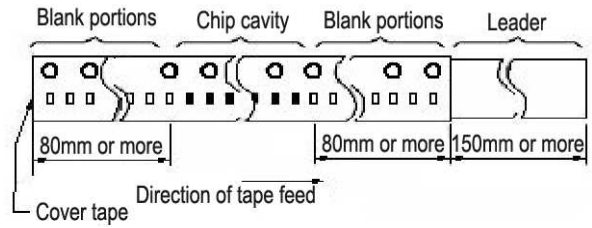

Reel Dimensions

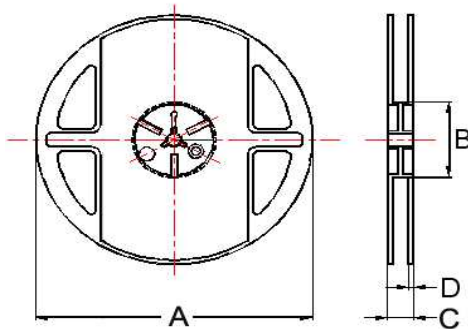

Dimensions in mm

TYPE	Tape Dimensions						Reel Dimensions				Quantity
	A	B	T	W	P	F	A	B	C	D	PCS / Reel
ASCQ0060303	0.37	0.67	0.42	8	2	3.5	180	60	13	1.5	15000