

### FEATURES

- Fits SOT-143 amplifier packages
- Input/Output blocking capacitors
- RF bypass and bias capacitors
- Dual bias resistors
- RF bias inductor
- RO-4350 board material
- Fits MicroAmp MH-series housings

The MicroAmp MB-3 circuit board is designed for rapid prototyping of many different RF MMIC amplifiers in SOT-143 4-pin packages that use a common RF output and bias pin from manufacturers such as Avago (MSA), Mini-Circuits (VAM), and others. This board will fit the MicroAmp MH series of connectorized housings that allow it to be used as a single amplifier stage or cascaded with other MicroAmp boards for added versatility. Boards are fabricated from a high-performance 13 mil thick RO-4350 laminate with RoHS compatible ENIG plating (electroless nickel/immersion gold) on both the component side and the solid bottom ground plane. The board measures 0.490" x 0.590" and mounts into the housing with four #1-72 screws. Amplifiers can be easily designed and assembled with standard surface-mount passive components. It includes provisions for input and output DC blocking capacitors (0603), RF and bias bypass capacitors (0603/0805), dual bias resistors for flexible thermal management (0805), and a RF bias inductor (0805 or 0603). Pads for the RF connectors allow the SMA center pins to be easily soldered to the board after it is installed into the housing, as well as a large pad to connect the completed board assembly to the bias feed-through.

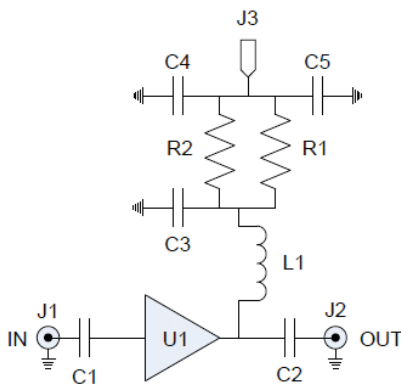

AMPLIFIER SCHEMATIC

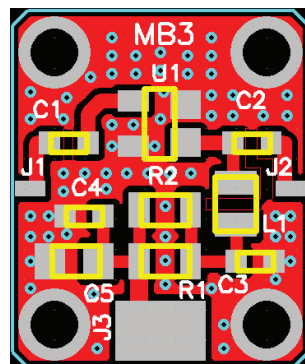

ASSEMBLY

### REF SIZE FUNCTION

REF	SIZE	FUNCTION
C1	0603	DC block
C2	0603	DC block
C3	0603	Bypass
C4	0603	Bypass
C5	0805	Bypass
R1	0805	DC bias
R2	0805	DC bias
L1	0805/0603	RF bias
U1	SOT-143	Amplifier
J1		Input
J2		Output
J3		Bias

For additional product information, please visit [www.twinind.com](http://www.twinind.com)

Contact information: 925-866-8946 (phone) 925-866-8947 (fax) Sales@twinind.com