

54ACQ374 • 54ACTQ374 Quiet Series Octal D Flip-Flop with TRI-STATE® Outputs

General Description

The 'ACQ/ACTQ374 is a high-speed, low-power octal D-type flip-flop featuring separate D-type inputs for each flip-flop and TRI-STATE outputs for bus-oriented applications. A buffered Clock (CP) and Output Enable (\overline{OE}) are common to all flip-flops.

The 'ACQ/ACTQ374 utilizes Quiet Series technology to guarantee quiet output switching and improve dynamic threshold performance. FACT Quiet Series™ features GTO™ output control and undershoot corrector in addition to a split ground bus for superior performance.

- Guaranteed simultaneous switching noise level and dynamic threshold performance
- Improved latch-up immunity
- Buffered positive edge-triggered clock
- TRI-STATE outputs drive bus lines or buffer memory address registers
- Outputs source/sink 24 mA
- Faster prop delays than the standard 'AC/ACT374
- 4 kV minimum ESD immunity
- Standard Military Drawing (SMD)
 - 'ACTQ374: 5962-92189
 - 'ACQ374: 5962-92179

Features

- I_{CC} and I_{OZ} reduced by 50%

Logic Symbols

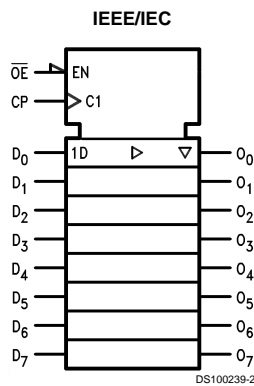
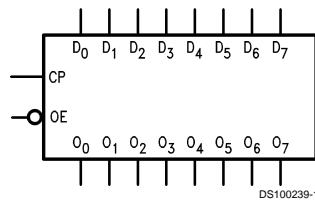

Connection Diagrams

Pin Assignment for DIP and Flatpak

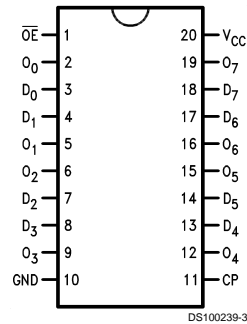

Pin Assignment for LCC

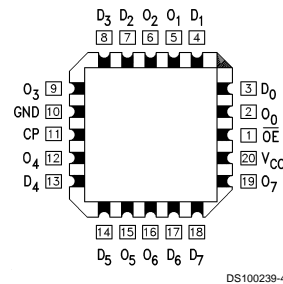

GTO™ is a trademark of National Semiconductor Corporation.
 TRI-STATE® is a registered trademark of National Semiconductor Corporation.
 FACT® is a registered trademark of Fairchild Semiconductor Corporation.
 FACT Quiet Series™ is a trademark of Fairchild Semiconductor Corporation.

Connection Diagrams (Continued)

Pin Names	Description
D ₀ -D ₇	Data Inputs
CP	Clock Pulse Input
\overline{OE}	TRI-STATE Output Enable Input
O ₀ -O ₇	TRI-STATE Outputs

Functional Description

The 'ACQ/ACTQ374 consists of eight edge-triggered flip-flops with individual D-type inputs and TRI-STATE true outputs. The buffered clock and buffered Output Enable are common to all flip-flops. The eight flip-flops will store the state of their individual D inputs that meet the setup and hold time requirements on the LOW-to-HIGH Clock (CP) transition. With the Output Enable (\overline{OE}) LOW, the contents of the eight flip-flops are available at the outputs. When the \overline{OE} is HIGH, the outputs go to the high impedance state. Operation of the \overline{OE} input does not affect the state of the flip-flops.

Truth Table

Inputs			Outputs
D _n	CP	\overline{OE}	O _n
H	↗	L	H
L	↗	L	L
X	X	H	Z

H = HIGH Voltage Level
 L = LOW Voltage Level
 X = Immaterial
 Z = High Impedance
 ↗ = LOW-to-HIGH Transition

Logic Diagram

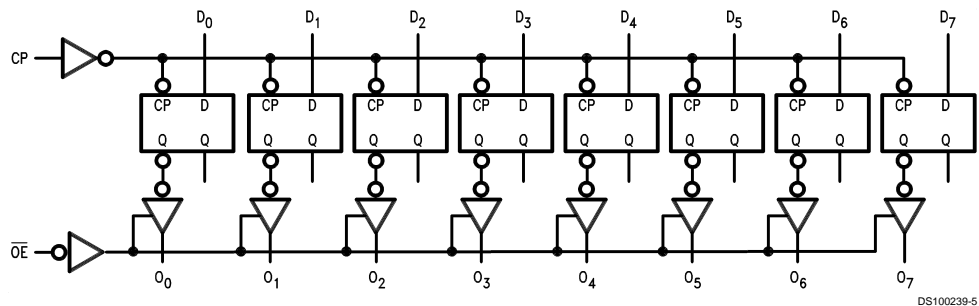

Please note that this diagram is provided only for the understanding of logic operations and should not be used to estimate propagation delays.

Absolute Maximum Ratings (Note 1)

If Military/Aerospace specified devices are required, please contact the National Semiconductor Sales Office/Distributors for availability and specifications.

Supply Voltage (V_{CC})	-0.5V to +7.0V
DC Input Diode Current (I_{IK})	
$V_I = -0.5V$	-20 mA
$V_I = V_{CC} + 0.5V$	+20 mA
DC Input Voltage (V_I)	-0.5V to $V_{CC} + 0.5V$
DC Output Diode Current (I_{OK})	
$V_O = -0.5V$	-20 mA
$V_O = V_{CC} + 0.5V$	+20 mA
DC Output Voltage (V_O)	-0.5V to $V_{CC} + 0.5V$
DC Output Source or Sink Current (I_O)	±50 mA
DC V_{CC} or Ground Current per Output Pin (I_{CC} or I_{GND})	±50 mA
Storage Temperature (T_{STG})	-65°C to +150°C
DC Latch-Up Source or Sink Current	±300 mA
Junction Temperature (T_J)	
CDIP	175°C

Recommended Operating Conditions

Supply Voltage (V_{CC})	
'ACQ	2.0V to 6.0V
'ACTQ	4.5V to 5.5V
Input Voltage (V_I)	0V to V_{CC}
Output Voltage (V_O)	0V to V_{CC}
Operating Temperature (T_A)	
54ACQ/ACTQ	-55°C to +125°C
Minimum Input Edge Rate $\Delta V/\Delta t$	
'ACQ Devices	
V_{IN} from 30% to 70% of V_{CC}	
V_{CC} @ 3.0V, 4.5V, 5.5V	125 mV/ns
Minimum Input Edge Rate $\Delta V/\Delta t$	
'ACTQ devices	
V_{IN} from 0.8V to 2.0V	
V_{CC} @ 4.5V, 5.5V	125 mV/ns

Note 1: Absolute maximum ratings are those values beyond which damage to the device may occur. The databook specifications should be met, without exception, to ensure that the system design is reliable over its power supply, temperature, and output/input loading variables. National does not recommend operation of FACT® circuits outside databook specifications.

Note 2: All commercial packaging is not recommended for applications requiring greater than 2000 temperature cycles from -40°C to +125°C.

DC Characteristics for 'ACQ Family Devices

Symbol	Parameter	V_{CC} (V)	54ACQ	Units	Conditions
			$T_A = -55^\circ\text{C to } +125^\circ\text{C}$		
			Guaranteed Limits		
V_{IH}	Minimum High Level Input Voltage	3.0	2.1	V	$V_{OUT} = 0.1V$ or $V_{CC} - 0.1V$
		4.5	3.15		
		5.5	3.85		
V_{IL}	Maximum Low Level Input Voltage	3.0	0.9	V	$V_{OUT} = 0.1V$ or $V_{CC} - 0.1V$
		4.5	1.35		
		5.5	1.65		
V_{OH}	Minimum High Level Output Voltage	3.0	2.9	V	$I_{OUT} = -50 \mu A$
		4.5	4.4		
		5.5	5.4		
V_{OL}	Maximum Low Level Output Voltage	3.0	2.4	V	(Note 3) $V_{IN} = V_{IL}$ or V_{IH} $I_{OH} = -12 \text{ mA}$ $I_{OH} = -24 \text{ mA}$ $I_{OH} = -24 \text{ mA}$
		4.5	3.7		
		5.5	4.7		
V_{OL}	Maximum Low Level Output Voltage	3.0	0.1	V	$I_{OUT} = 50 \mu A$
		4.5	0.1		
		5.5	0.1		
V_{OL}	Maximum Low Level Output Voltage	3.0	0.50	V	(Note 3) $I_{OL} = 12 \text{ mA}$ $I_{OL} = 24 \text{ mA}$ $I_{OL} = 24 \text{ mA}$
		4.5	0.50		
		5.5	0.50		
I_{IN}	Maximum Input Leakage Current	5.5	±1.0	μA	$V_I = V_{CC}, GND$ (Note 5)
I_{OLD}	(Note 4) Minimum Dynamic Output Current	5.5	50	mA	$V_{OLD} = 1.65V \text{ Max}$
I_{OHD}		5.5	-50	mA	$V_{OHD} = 3.85V \text{ Min}$

DC Characteristics for 'ACQ Family Devices (Continued)

Symbol	Parameter	V _{CC} (V)	54ACQ	Units	Conditions
			T _A = -55°C to +125°C		
			Guaranteed Limits		
I _{CC}	Maximum Quiescent Supply Current	5.5	80.0	μA	V _{IN} = V _{CC} or GND (Note 5)
I _{OZ}	Maximum TRI-STATE Leakage Current	5.5	±5.0	μA	V _{I(OE)} = V _{IL} , V _{IH} V _I = V _{CC} , GND V _O = V _{CC} , GND
V _{OLP}	Quiet Output Maximum Dynamic V _{OL}	5.0	1.5	V	(Notes 6, 7)
V _{OLV}	Quiet Output Minimum Dynamic V _{OL}	5.0	-1.2	V	(Notes 6, 7)

Note 3: All outputs loaded; thresholds on input associated with output under test.

Note 4: Maximum test duration 2.0 ms, one output loaded at a time.

Note 5: I_{IN} and I_{CC} @ 3.0V are guaranteed to be less than or equal to the respective limit @ 5.5V V_{CC}.
I_{CC} for 54ACQ @ 25°C is identical to 74ACQ @ 25°C.

Note 6: Plastic DIP Package.

Note 7: Max number of outputs defined as (n). Data inputs are driven 0V to 5V. One output @ GND.

Note 8: Max number of data inputs (n) switching. (n-1) inputs switching 0V to 5V ('ACQ). Input-under-test switching: 5V to threshold (V_{ILD}), 0V to threshold (V_{IHD}), f = 1 MHz.

DC Characteristics for 'ACTQ Family Devices

Symbol	Parameter	V _{CC} (V)	54ACTQ	Units	Conditions
			T _A = -55°C to +125°C		
			Guaranteed Limits		
V _{IH}	Minimum High Level Input Voltage	4.5	2.0	V	V _{OUT} = 0.1V or V _{CC} - 0.1V
		5.5	2.0		
V _{IL}	Maximum Low Level Input Voltage	4.5	0.8	V	V _{OUT} = 0.1V or V _{CC} - 0.1V
		5.5	0.8		
V _{OH}	Minimum High Level Output Voltage	4.5	4.4	V	I _{OUT} = -50 μA
		5.5	5.4		
		4.5	3.70	V	(Note 9) V _{IN} = V _{IL} or V _{IH} I _{OH} = -24 mA I _{OH} = -24 mA
		5.5	4.70		
V _{OL}	Maximum Low Level Output Voltage	4.5	0.1	V	I _{OUT} = 50 μA
		5.5	0.1		
		4.5	0.50	V	(Note 9) V _{IN} = V _{IL} or V _{IH} I _{OL} = 24 mA I _{OL} = 24 mA
		5.5	0.50		
I _{IN}	Maximum Input Leakage Current	5.5	±1.0	μA	V _I = V _{CC} , GND
I _{OZ}	Maximum TRI-STATE Current	5.5	±5.0	μA	V _I = V _{IL} , V _{IH} V _O = V _{CC} , GND
I _{CCT}	Maximum I _{CC} /Input	5.5	1.6	mA	V _I = V _{CC} - 2.1V
I _{OLD}	(Note 9) Minimum Dynamic Output Current	5.5	50	mA	V _{OLD} = 1.65V Max
I _{OHD}		5.5	-50	mA	V _{OHD} = 3.85V Min

DC Characteristics for 'ACTQ Family Devices (Continued)

Symbol	Parameter	V _{CC} (V)	54ACTQ		Units	Conditions
			T _A = -55°C to +125°C			
			Guaranteed Limits			
I _{CC}	Maximum Quiescent Supply Current	5.5	80.0		μA	V _{IN} = V _{CC} or GND (Note 11)
V _{OLP}	Quiet Output Maximum Dynamic V _{OL}	5.0	1.5		V	(Notes 12, 13)
V _{OLV}	Quiet Output Minimum Dynamic V _{OL}	5.0	-1.2		V	(Notes 12, 13)

Note 9: All outputs loaded; thresholds on input associated with output under test.

Note 10: Maximum test duration 2.0 ms, one output loaded at a time.

Note 11: I_{CC} for 54ACTQ @ 25°C is identical to 74ACTQ @ 25°C.

Note 12: Plastic DIP package.

Note 13: Max number of outputs defined as (n). Data inputs are driven 0V to 3V. One output @ GND

Note 14: Max number of data inputs (n) switching. (n-1) inputs switching 0V to 3V ('ACTQ). Input-under-test switching: 3V to threshold (V_{ILD}), 0V to threshold (V_{IHD}), f = 1 MHz.

AC Electrical Characteristics

Symbol	Parameter	V _{CC} (V) (Note 15)	54ACQ		Units	Fig. No.
			T _A = -55°C to +125°C			
			C _L = 50 pF			
		Min	Max			
f _{max}	Maximum Clock Frequency	3.3 5.0	95 95		MHz	
t _{PLH} , t _{PHL}	Propagation Delay CP to O _n	3.3 5.0	1.0	16.5 11.0	ns	
t _{PZL} , t _{PZH}	Output Enable Time	3.3 5.0	1.0	16.5 11.5	ns	
t _{PHZ} , t _{PLZ}	Output Disable Time	3.3 5.0	1.0	12.0 10.5	ns	

Note 15: Voltage Range 5.0 is 5.0V ±0.5V

Voltage Range 3.3 is 3.3V ±0.3V

AC Operating Requirements

Symbol	Parameter	V _{CC} (V) (Note 16)	54ACQ		Units	Fig. No.
			T _A = -55°C to +125°C			
			C _L = 50 pF			
		Guaranteed Minimum				
t _s	Setup Time, HIGH or LOW D _n to CP	3.3 5.0	3.0 3.0		ns	
t _h	Hold Time, HIGH or LOW D _n to CP	3.3 5.0	2.0 1.5		ns	
t _w	CP Pulse Width, HIGH or LOW	3.3 5.0	5.0 5.0		ns	

Note 16: Voltage Range 5.0 is 5.0V ±0.5V

Voltage Range 3.3 is 3.3V ±0.3V

AC Electrical Characteristics

Symbol	Parameter	V _{CC} (V) (Note 17)	54ACTQ		Units	Fig. No.
			T _A = -55°C to +125°C C _L = 50 pF			
			Min	Max		
f _{max}	Maximum Clock Frequency	5.0	95		MHz	
t _{PLH} , t _{PHL}	Propagation Delay CP to O _n	5.0	2.0	11.5	ns	
t _{PZL} , t _{PZH}	Output Enable Time	5.0	2.0	11.5	ns	
t _{PHZ} , t _{PLZ}	Output Disable Time	5.0	1.5	10.5	ns	

Note 17: Voltage Range 5.0 is 5.0V ±0.5V

AC Operating Requirements

Symbol	Parameter	V _{CC} (V) (Note 18)	54ACTQ		Units	Fig. No.
			T _A = -55°C to +125°C C _L = 50 pF			
			Guaranteed Minimum			
t _s	Setup Time, HIGH or LOW D _n to CP	5.0	3.5		ns	
t _h	Hold Time, HIGH or LOW D _n to CP	5.0	2.0		ns	
t _w	CP Pulse Width, HIGH or LOW	5.0	5.0		ns	

Note 18: Voltage Range 5.0 is 5.0V ±0.5V

Capacitance

Symbol	Parameter	Typ	Units	Conditions
C _{IN}	Input Capacitance	4.5	pF	V _{CC} = OPEN
C _{PD}	Power Dissipation Capacitance	42.0	pF	V _{CC} = 5.0V

Physical Dimensions inches (millimeters) unless otherwise noted

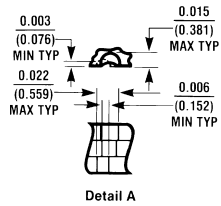
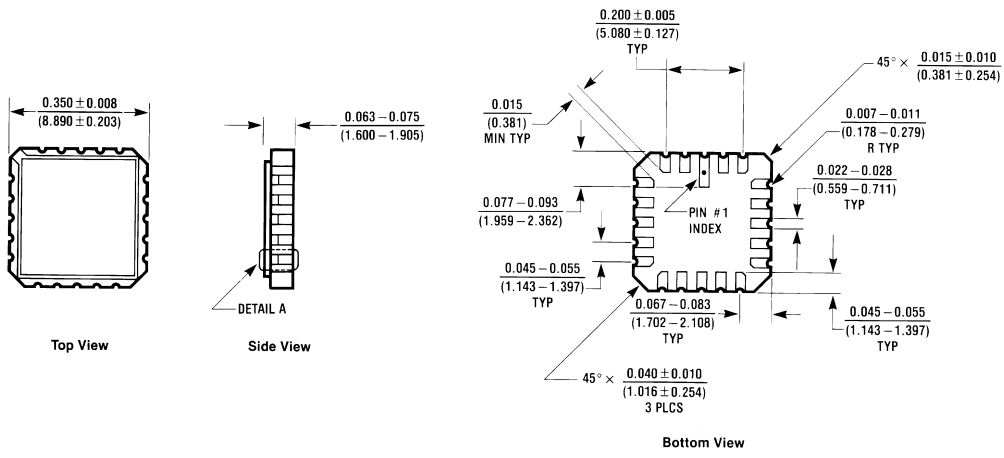

E20A (REV D)

20-Terminal Ceramic Leadless Chip Carrier (L)
NS Package Number E20A

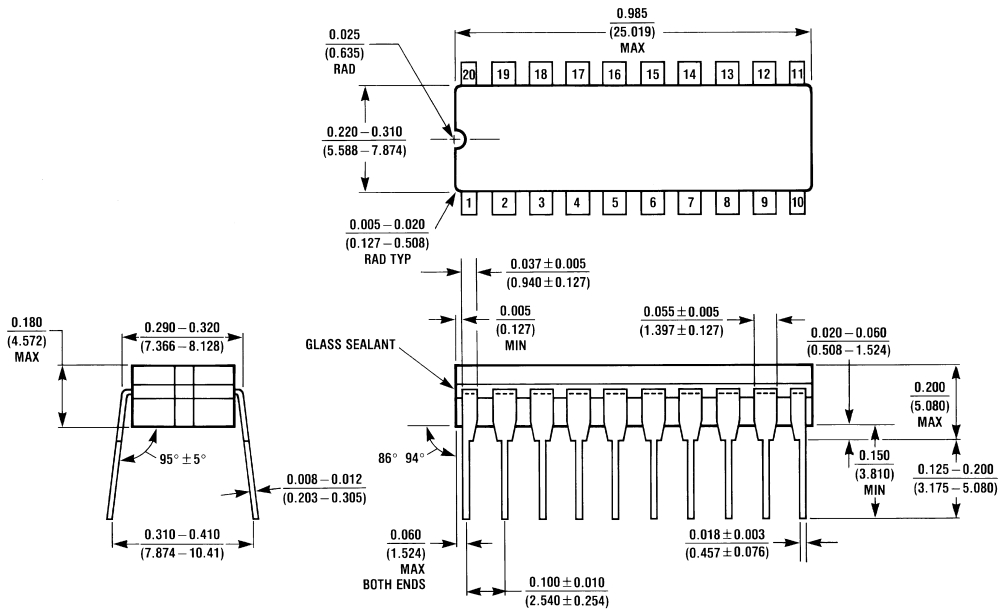

J20A (REV M)

20-Lead Ceramic Dual-In-Line Package (D)
NS Package Number J20A

Physical Dimensions inches (millimeters) unless otherwise noted (Continued)

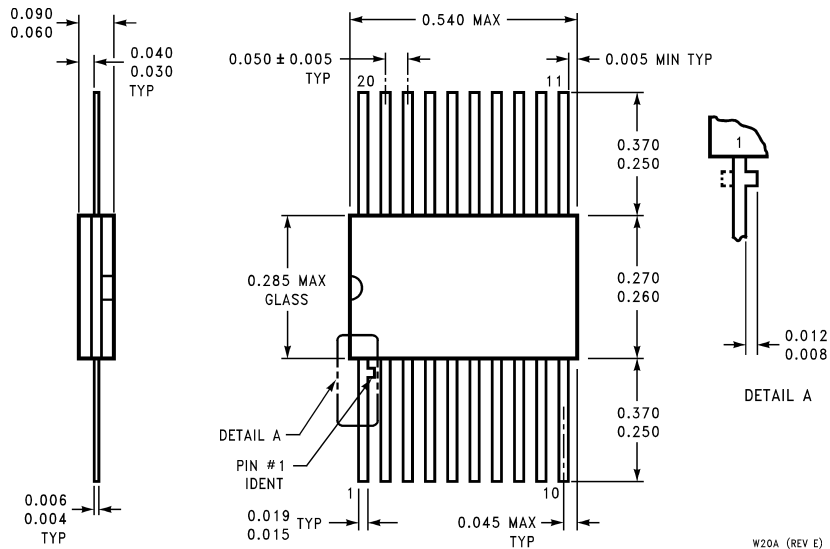

**20-Lead Ceramic Flatpak (F)
NS Package Number W20A**

LIFE SUPPORT POLICY

NATIONAL'S PRODUCTS ARE NOT AUTHORIZED FOR USE AS CRITICAL COMPONENTS IN LIFE SUPPORT DEVICES OR SYSTEMS WITHOUT THE EXPRESS WRITTEN APPROVAL OF THE PRESIDENT OF NATIONAL SEMICONDUCTOR CORPORATION. As used herein:

1. Life support devices or systems are devices or systems which, (a) are intended for surgical implant into the body, or (b) support or sustain life, and whose failure to perform when properly used in accordance with instructions for use provided in the labeling, can be reasonably expected to result in a significant injury to the user.
2. A critical component in any component of a life support device or system whose failure to perform can be reasonably expected to cause the failure of the life support device or system, or to affect its safety or effectiveness.



National Semiconductor Corporation
Americas
Tel: 1-800-272-9959
Fax: 1-800-737-7018
Email: support@nsc.com

National Semiconductor Europe
Fax: +49 (0) 1 80-530 85 86
Email: europe.support@nsc.com
Deutsch Tel: +49 (0) 1 80-530 85 85
English Tel: +49 (0) 1 80-532 78 32
Français Tel: +49 (0) 1 80-532 93 58
Italiano Tel: +49 (0) 1 80-534 16 80

National Semiconductor Asia Pacific Customer Response Group
Tel: 65-2544466
Fax: 65-2504466
Email: sea.support@nsc.com

National Semiconductor Japan Ltd.
Tel: 81-3-5620-6175
Fax: 81-3-5620-6179

www.national.com

See Military/Aerospace Products

[Products](#) > [Military/Aerospace](#) > [Logic](#) > [FACT ACTQ](#) > [54ACTQ374](#)

54ACTQ374 Product Folder

Quiet Series Octal D Flip-Flop with TRI-STATE Outputs





General Description	Features	Datasheet	Package & Models	Samples & Pricing
-------------------------------------	--------------------------	---------------------------	--------------------------------------	---------------------------------------

Datasheet

Title	Size in Kbytes	Date	View Online	Download	Receive via Email
54ACQ374 54ACTQ374 Quiet Series Octal D Flip-Flop with TRI-STATE Outputs	173 Kbytes	4-Sep-98	View Online	Download	Receive via Email
54ACTQ374 Mil-Aero Datasheet MN54ACTQ374-X	17 Kbytes		View Online	Download	Receive via Email
54ACTQ374 Mil-Aero Datasheet MV54ACTQ374-X	22 Kbytes		View Online	Download	Receive via Email

If you have trouble printing or viewing PDF file(s), see [Printing Problems](#).

Package Availability, Models, Samples & Pricing

Part Number	Package			Status	Models		Samples & Electronic Orders	Budgetary Pricing		Std Pack Size	Package Marking
	Type	Pins	MSL		SPICE	IBIS		Qty	\$US each		
5962-9218901M2A (54ACTQ374LMQB)	LCC	20	MSL	Full production	N/A	N/A	Buy Now	50+	\$9.8000	rail of 50	 cZcSc4cA 54ACTQ374 LMQB /QcMSE 5962-9218901M2A
5962R9218901M2A (54ACTQ374LMQB-R)	LCC	20	MSL	Full production	N/A	N/A		50+	\$70.0000	rail of 50	 cZcSc4cA 54ACTQ374 LMQB-R R9218901 M2A QcMSE
5962-9218901MRA (54ACTQ374DMQB)	CERDIP	20	MSL	Full production	N/A	N/A	Buy Now	50+	\$9.0000	rail of 20	 cZcSc4cASE 54ACTQ374DMQB /QcM 5962-9218901MRA
5962R9218901MRA (54ACTQ374DMQB-R)	CERDIP	20	MSL	Full production	N/A	N/A		50+	\$75.0000	rail of 20	 cZcSc4cASE 54ACTQ374DMQB-R /QcM 5962R9218901MRA
5962-9218901MSA (54ACTQ374FMQB)	CERPACK	20	MSL	Full production	N/A	N/A	Buy Now	50+	\$9.8000	rail of 19	 cZcSc4cASE 54ACTQ374FMQB /QcM 5962-9218901MSA

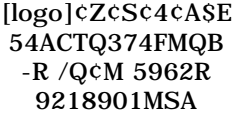
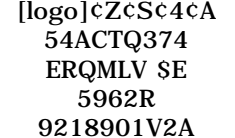
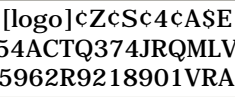
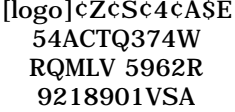
5962R9218901MSA (54ACTQ374FMQB-R)	CERPACK	20	MSL	Full production	N/A	N/A		50+	\$70.0000	rail of 19	 cZcSc4cASE 54ACTQ374FMQB -R /QcM 5962R 9218901MSA
5962R9218901V2A (54ACTQ374ERQMLV)	LCC	20	MSL	Full production	N/A	N/A		50+	\$138.0000	rail of 50	 cZcSc4cA 54ACTQ374 ERQMLV SE 5962R 9218901V2A
5962R9218901VRA (54ACTQ374JRQMLV)	CERDIP	20	MSL	Full production	N/A	N/A		50+	\$138.0000	rail of 20	 cZcSc4cASE 54ACTQ374JRQMLV 5962R9218901VRA
RM54ACTQ374VSA	CERPACK	20	MSL	Preliminary	N/A	N/A				rail of N/A	RM54ACTQ374VSA cR WAFER #
5962R9218901VSA (54ACTQ374WRQMLV)	CERPACK	20	MSL	Full production	N/A	N/A		50+	\$138.0000	rail of 19	 cZcSc4cASE 54ACTQ374W RQMLV 5962R 9218901VSA

General Description

The 'ACQ/'ACTQ374 is a high-speed, low-power octal D-type flip-flop featuring separate D-type inputs for each flip-flop and TRI-STATE outputs for bus-oriented applications. A buffered Clock (CP) and Output Enable (OE#) are common to all flip-flops.

The 'ACQ/'ACTQ374 utilizes Quiet Series technology to guarantee quiet output switching and improve dynamic threshold performance. FACT Quiet Series features GTO output control and undershoot corrector in addition to a split ground bus for superior performance.

Features

- I_{CC} and I_{OZ} reduced by 50%
- Guaranteed simultaneous switching noise level and dynamic threshold performance
- Improved latch-up immunity
- Buffered positive edge-triggered clock
- TRI-STATE outputs drive bus lines or buffer memory address registers
- Outputs source/sink 24 mA
- Faster prop delays than the standard 'AC/'ACT374
- 4 kV minimum ESD immunity
- Standard Military Drawing (SMD)
 - 'ACTQ374: 5962-92189
 - 'ACQ374: 5962-92179

[Information as of 5-Aug-2002]

[Search](#)

[Design](#)

[Purchasing](#)

[Quality](#)

[Company](#)

[Home](#)

[About Languages](#) . [Website Guide](#) . [About "Cookies"](#) . National is [QS 9000 Certified](#) . [Privacy/Security Statement](#) .
[Contact Us](#) . [Site Terms & Conditions of Use](#) . Copyright 2002 © National Semiconductor Corporation . [My Preferences](#) .

[Feedback](#)