

LTpowerPlanner III System-Level Design Tool Quick Start Guide

Ver. 3.0.0
January 2016

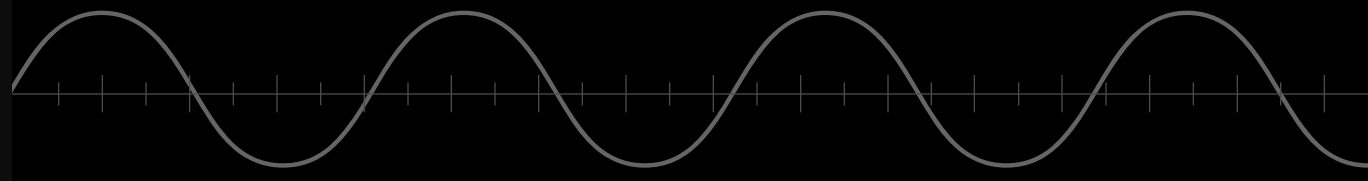

Design Tool Development Team
Applications Engineering
Power Products, Linear Technology Corp.

LTpowerCAD@linear.com

Linear Technology Corporation Copyright.

Last Update: 1/2016



LTpowerPlanner™

A System-Level Power Architecture Planning Tool:

- ✓ Create a **“Power Tree”** diagram of your Power Management System
- ✓ Estimate **Total System Power, Efficiency and Solution Size**
- ✓ **Compare** different system architectures for optimum solution
- ✓ Display and Copy Block Diagram for **System Presentation**
- ✓ Save and Load System Design Files for **Project Organization**
- ✓ Interface with LTspice™ Simulation file
- ✓ Interface with LTpowerCAD™ Design Tool file
- ✓ Available in LTpowerCAD Toolbox, **free download** at www.linear.com/ltpowercad
- ✓ Offline program on PC with Windows 7, 8 or 10.

LTpowerPlanner™

Located inside the LTpowerCAD “LTC Toolbox”:

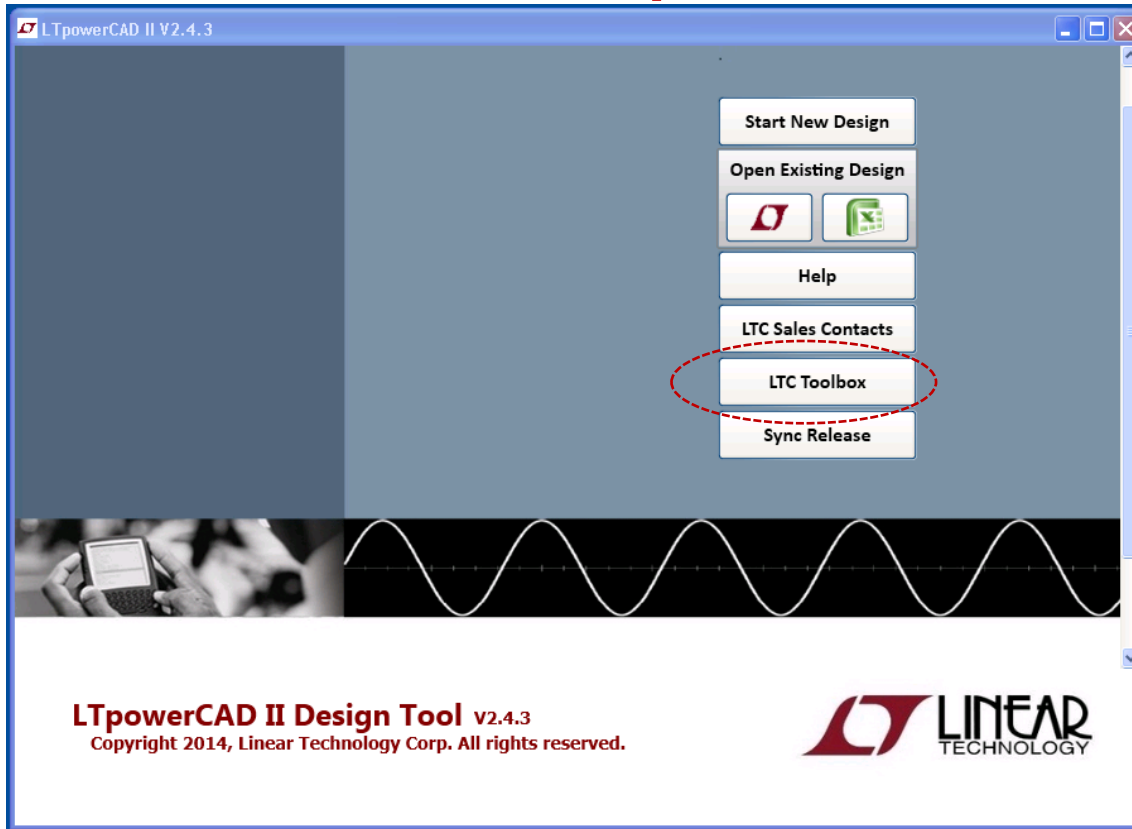

- Both **LTpowerPlanner III** and LTpowerPlanner II programs are listed.
- The previous LTpowerPlanner II program is NOT recommended for new designs.
- LTpowerCAD program is available at www.linear.com/LTpowerCAD

LTpowerPlanner™

Intuitive Power System Planning

Create System “Power Tree”

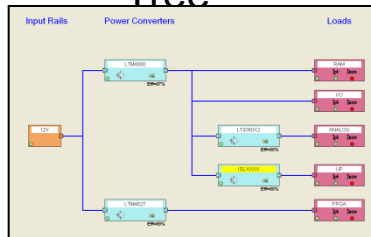

Design / Calculation

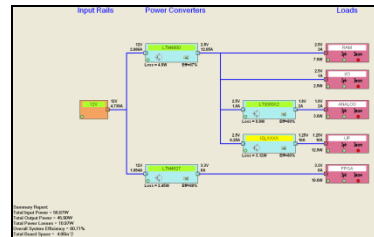

Save Design

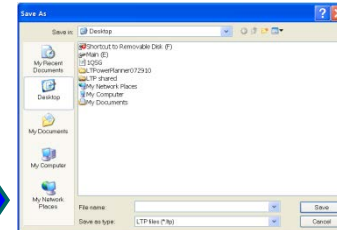

Print

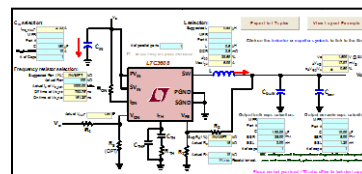
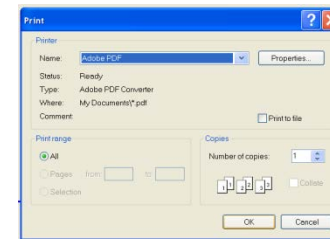

Interface With
LTpowerCAD™
Design Tool

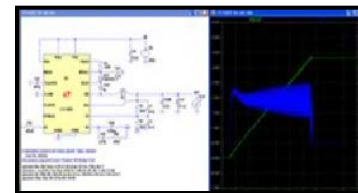

Interface With
LTspice™
Simulation Tool

LTpowerPlanner™

A Simple Design Example

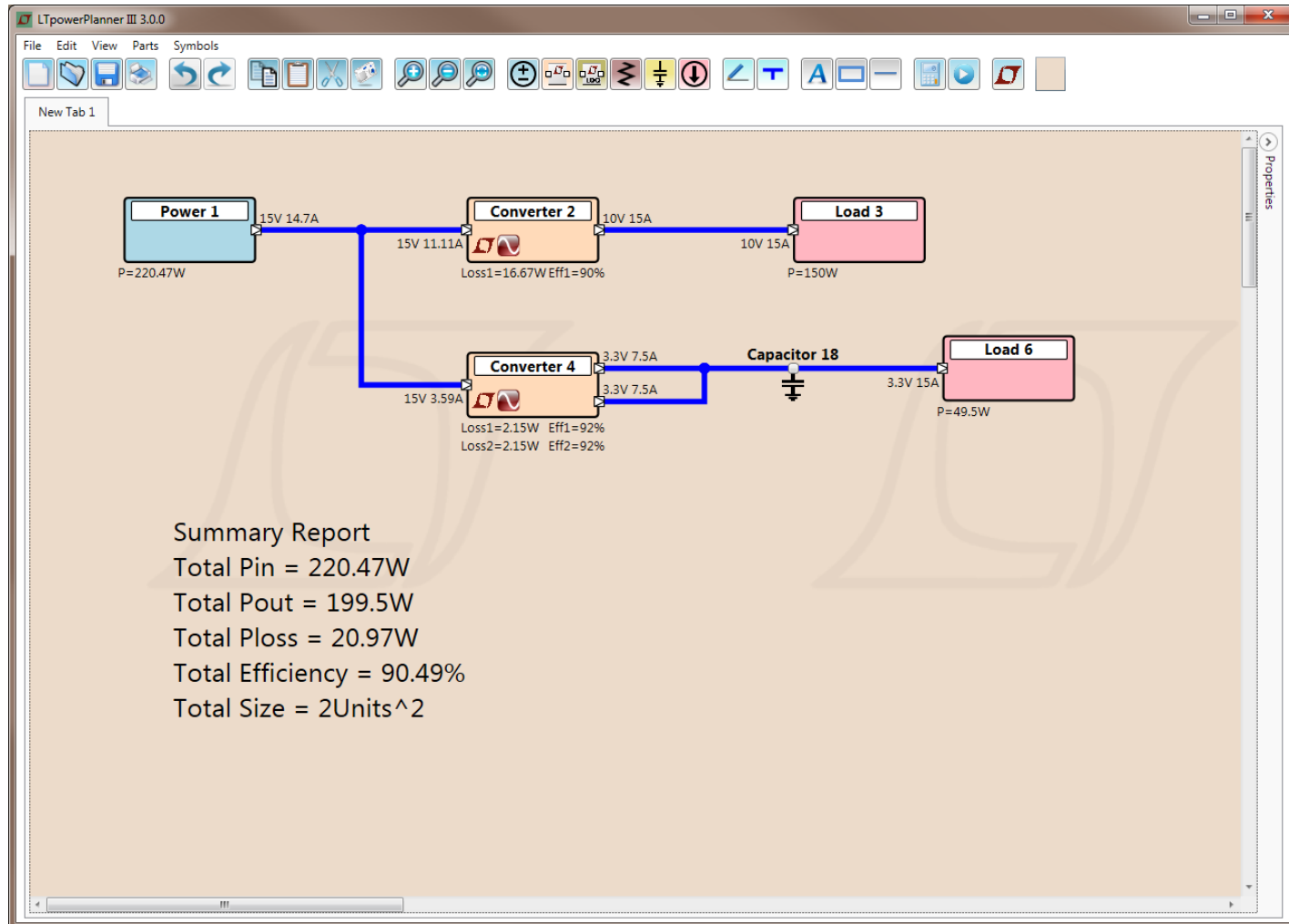

LTpowerPlanner™

Get Started with an Example

Main Screen

Toolbar
Tool Strip / Icons

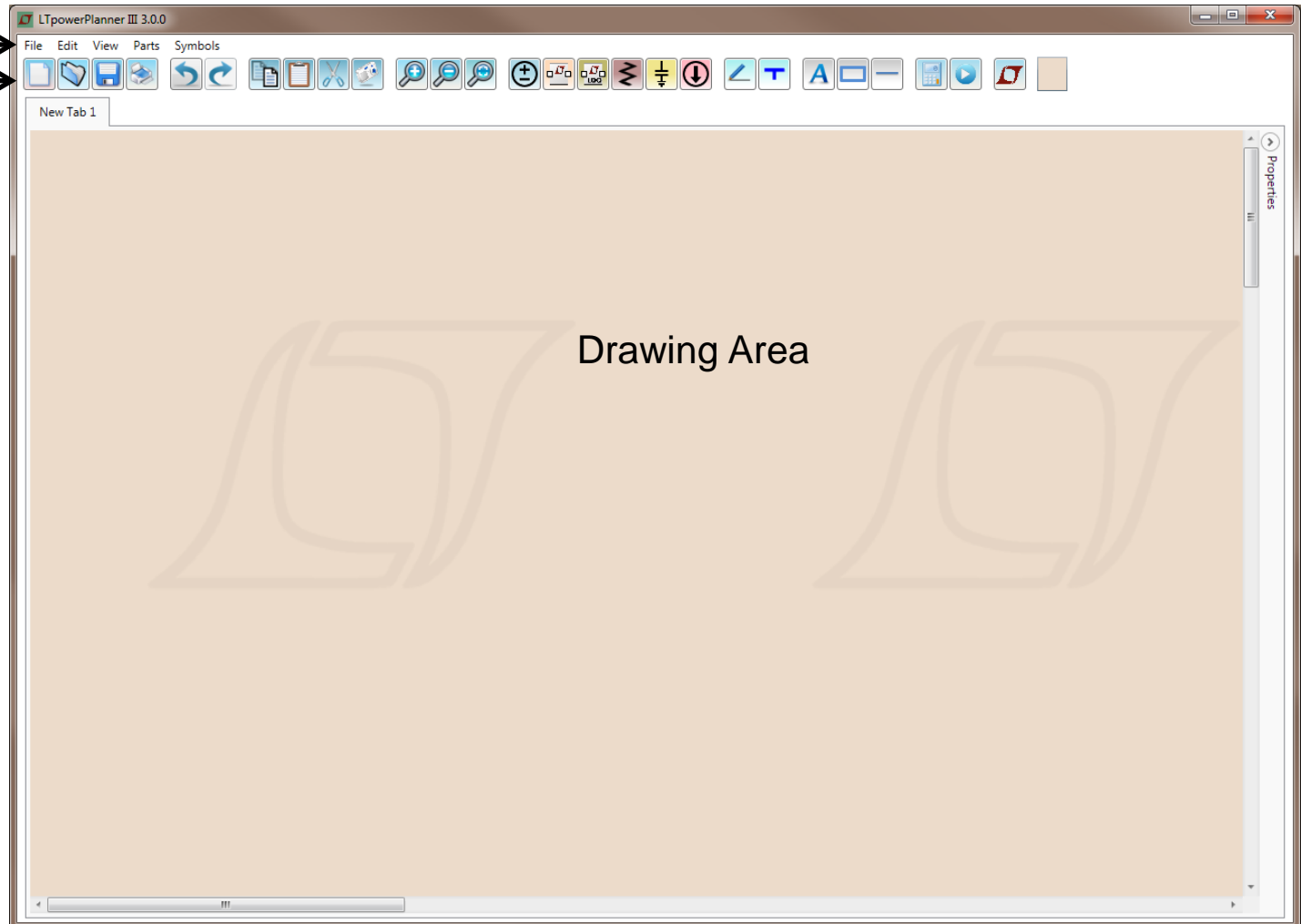

Components Toolbar

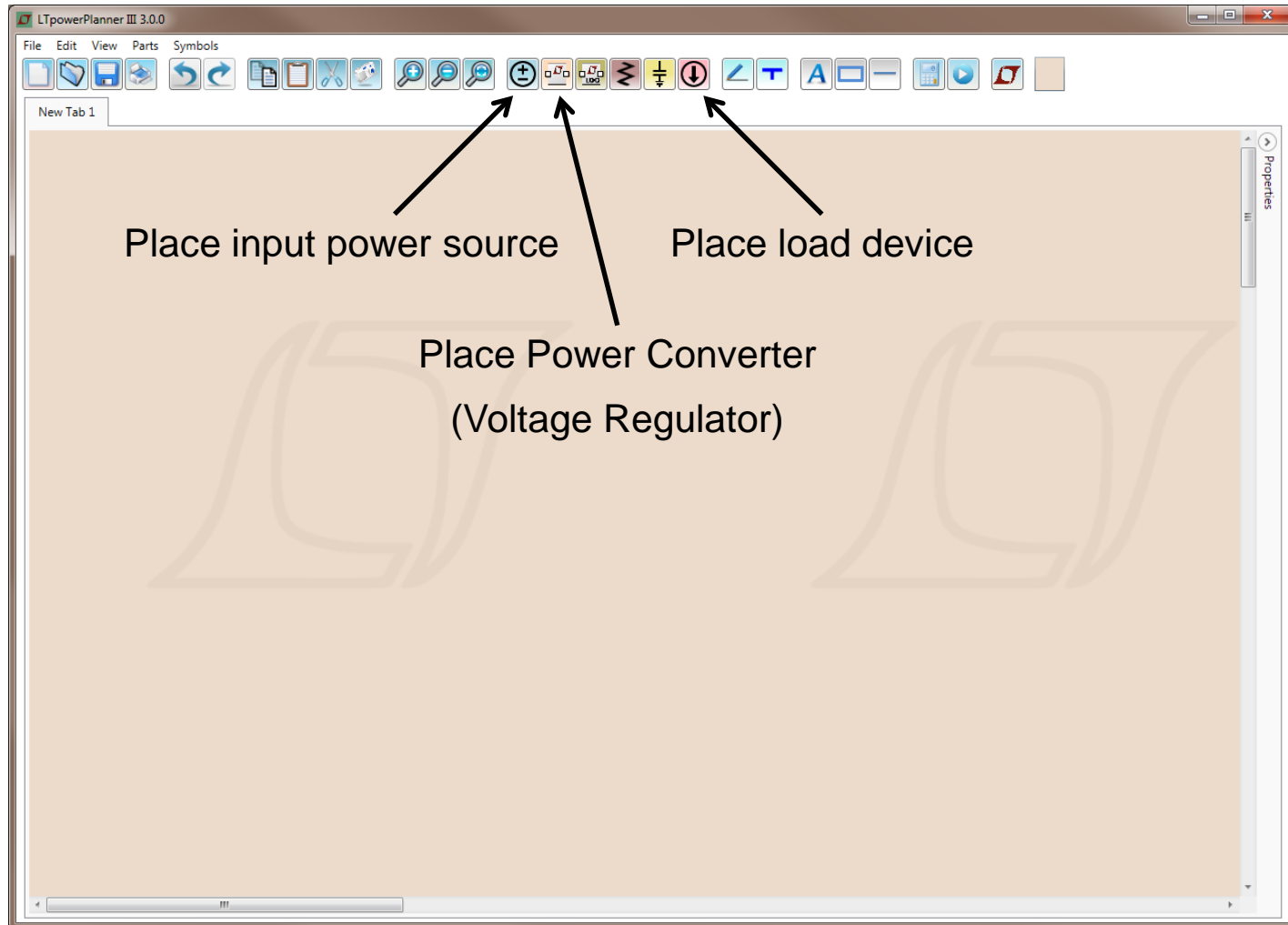

Components

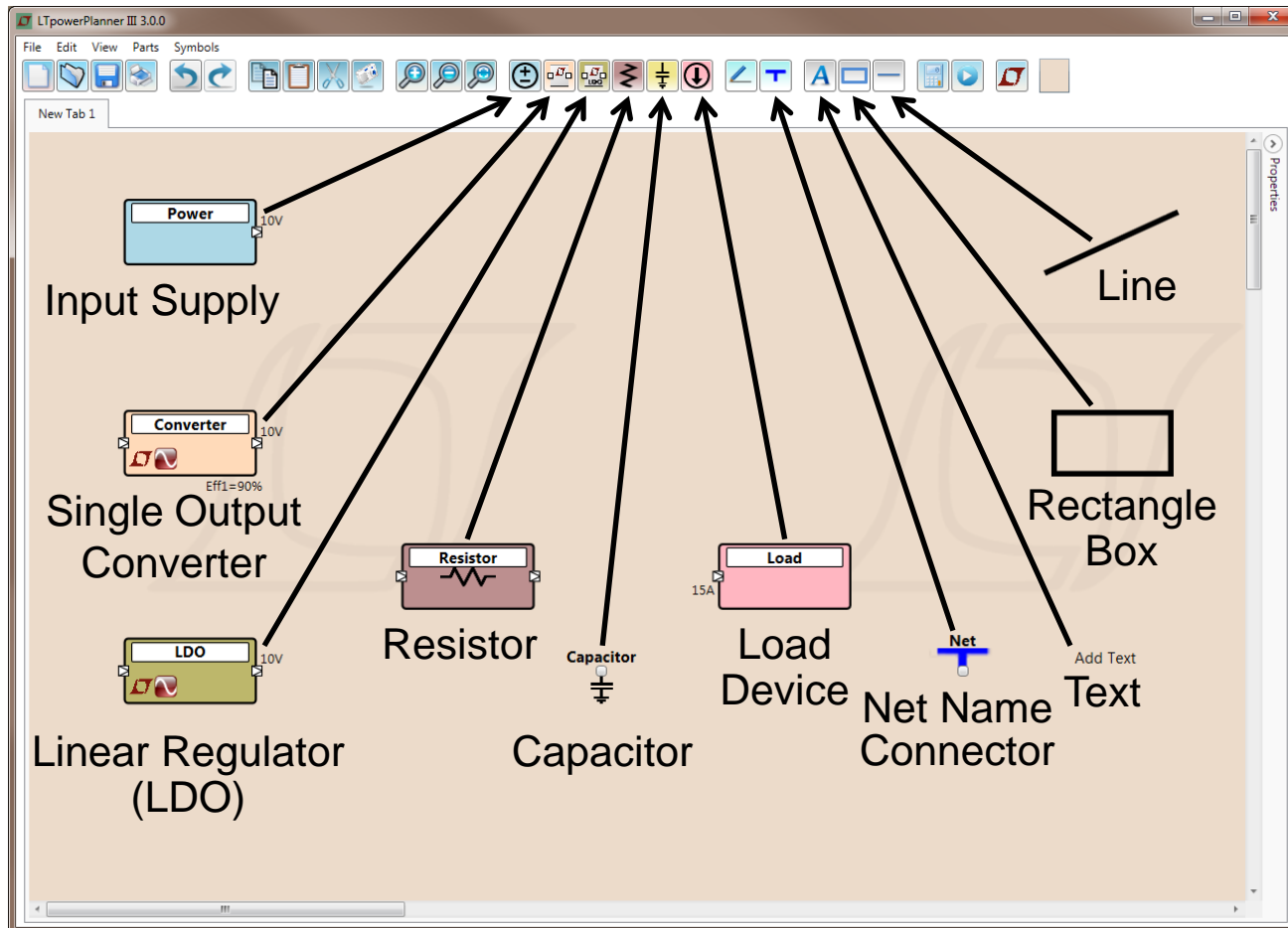

The Basics – Step 1: Add Parts

Click **Power, Converter or Load Icon** on the tool strip and drop the part onto the drawing area.

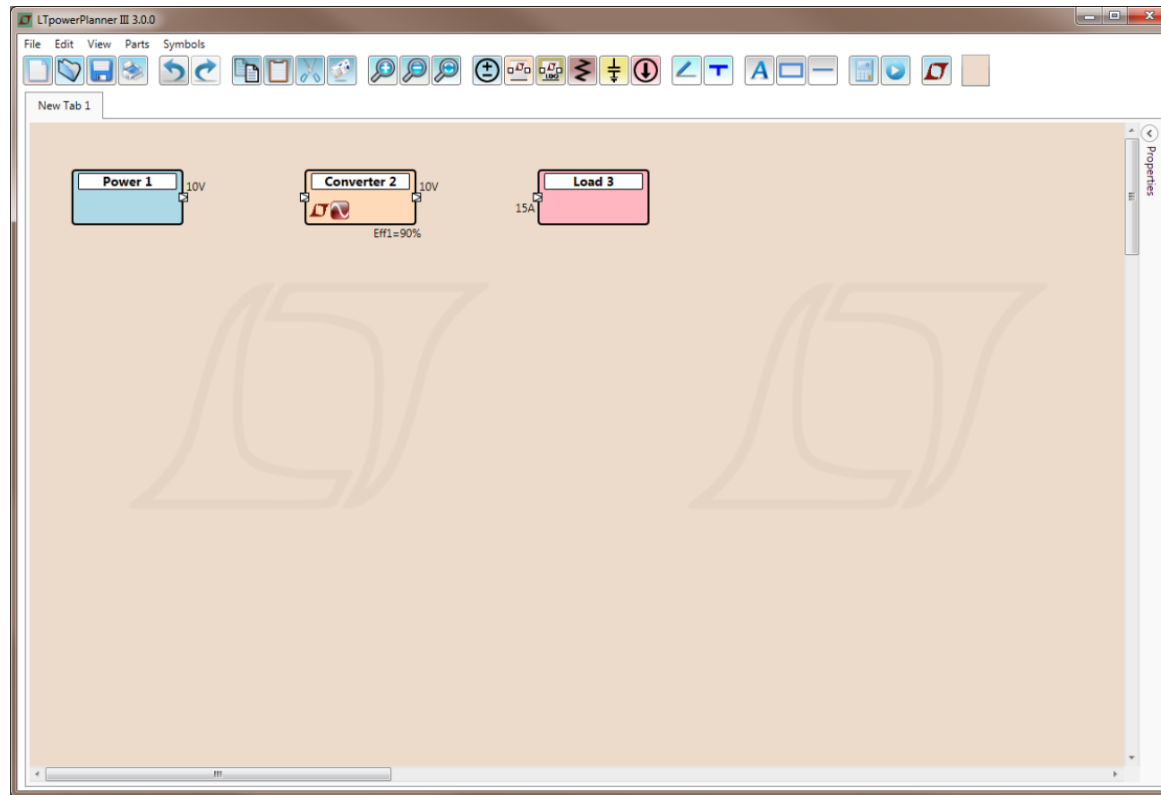

- By default, the input power source only has an output terminal. Converters have both input and output terminals. The load only has input terminals.
- **The input is always on the left side and the output is always on the right side.**

The Basics – Step 2: Make Connections

Add connections. Add a wire connecting Converter 2 to Load 3: **First click on the  Icon.** While in “Draw Wire” mode, the cursor will become a cross-hair. **Click Converter2’s output terminal.** Then release the mouse. **Next click on Load3’s input terminal** to create the wire. Right-click the Drawing Area to cancel “Draw Wire” mode.

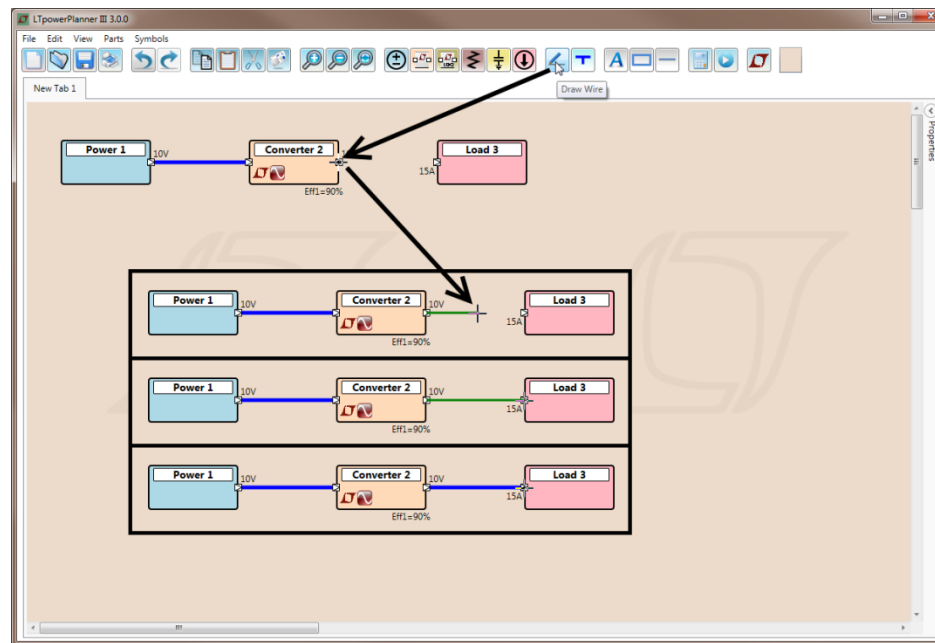

Notes:

1. Using an external mouse makes it easy to draw wires (instead of laptop PC touch pad/mouse)
2. The current program does **NOT** support “click-and-drag” to draw connection wire.
3. Routes requiring 90° turns must be placed by the user.

The Basics – Step 3: Part Properties

Change part properties. **Double click** on part labeled “Converter 2” to open the “Properties Tab”. Update the text box entries appropriate to the desired values.

Double Click

Pressing this arrow will keep the “Properties Tab” always open or always closed when a single part is selected. Shortcut is “Space”

Note: the values with blue cell background color are used for power calculation or interface with LTpowerCAD search.

The Basics – Step 3: Part Properties

Each component has a unique “Properties” box which allows the appropriate fields to be edited.

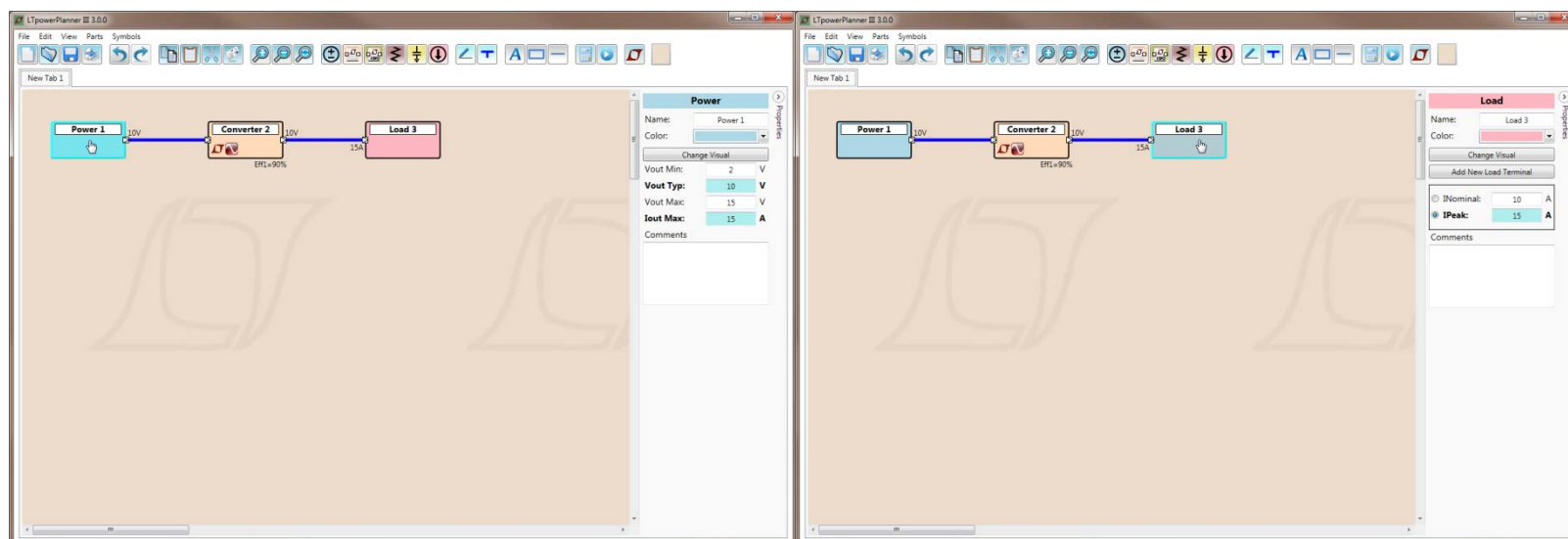

Power Source Properties

Load Device Properties

The Basics – Step 4: Calculate Parameters

Calculate parameters. Click the “Run” icon on the tool strip to calculate system efficiency, losses and total solution size.

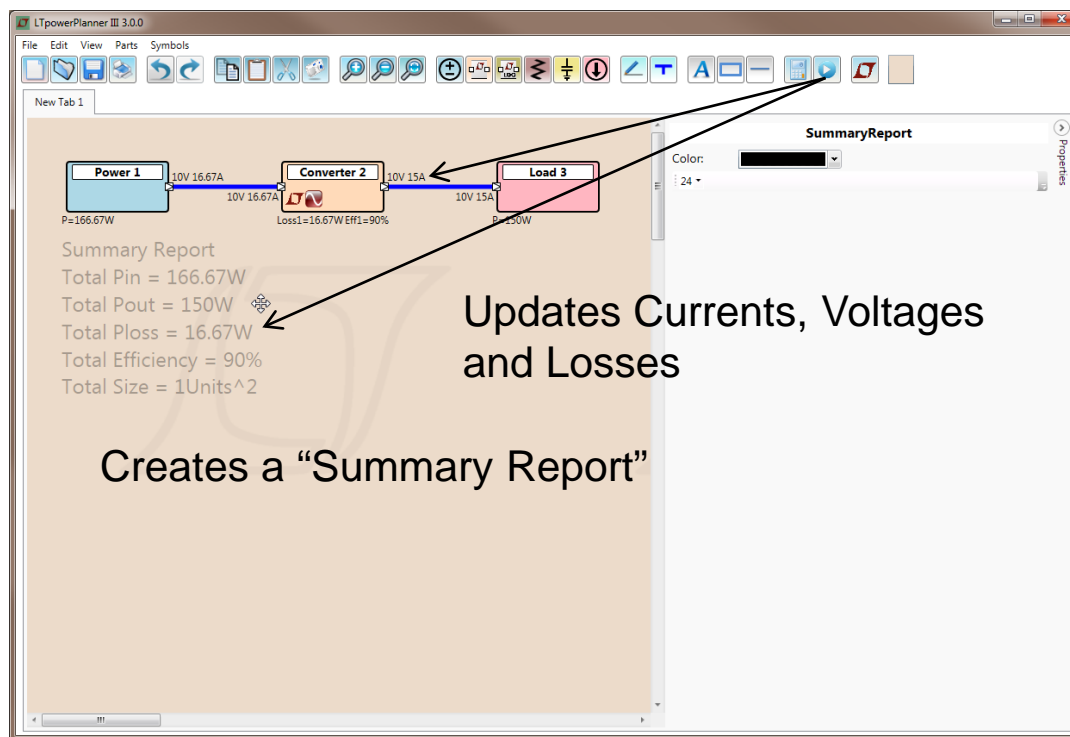

A design project is saved as an **.ltp3** file.

Note:

1. The user needs to **manually enter** the estimated efficiency and size of each converter to generate estimated total efficiency and board space.

Design Example – Functions & Features(1)

Move. Click and drag a part to move it to a new location. Dragging will snap parts in line with other parts and wire lines.

Step 1. Drag
(to select)

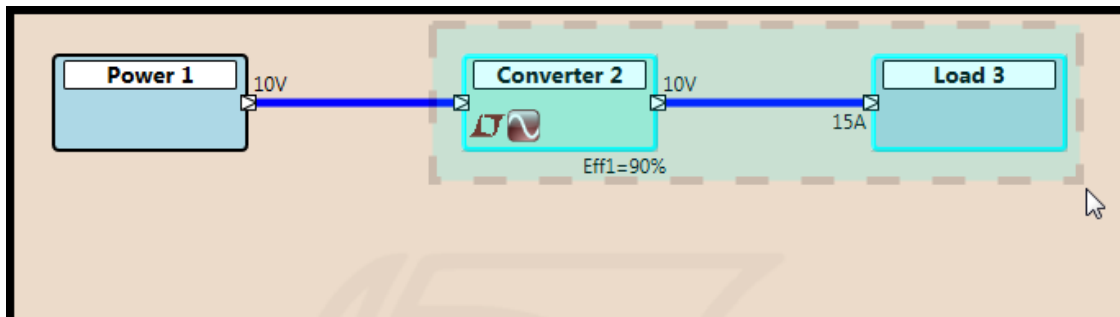

Step 2. Click & Hold
(to drag)

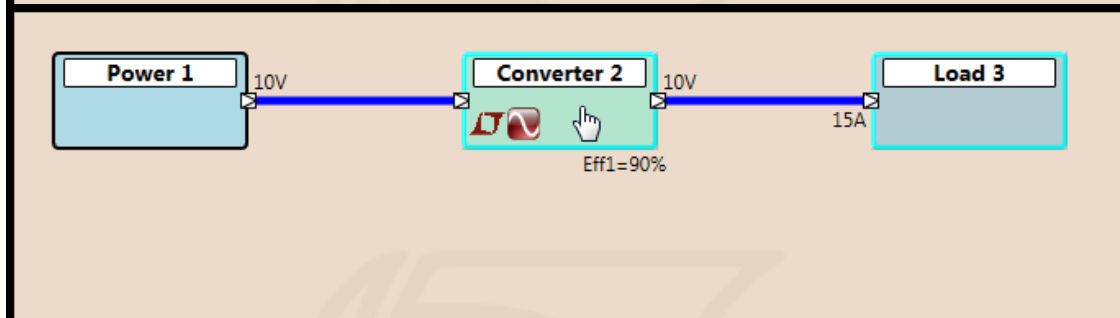

Step 3. Drag and Release
(to a new location)

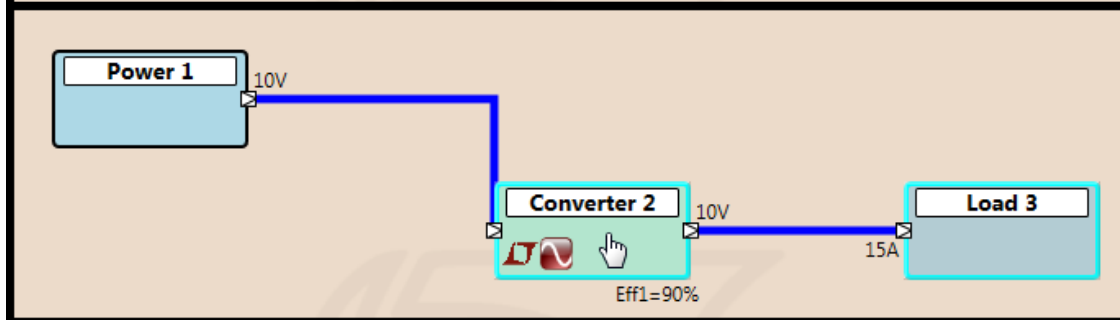

Design Example – Functions & Features(2)

Zoom. Click the “Zoom In” icon on the tool strip menu. This will increment the zoom by one step. “Zoom Out” is opposite this function. “Zoom to Fit” automatically sizes the zoom.

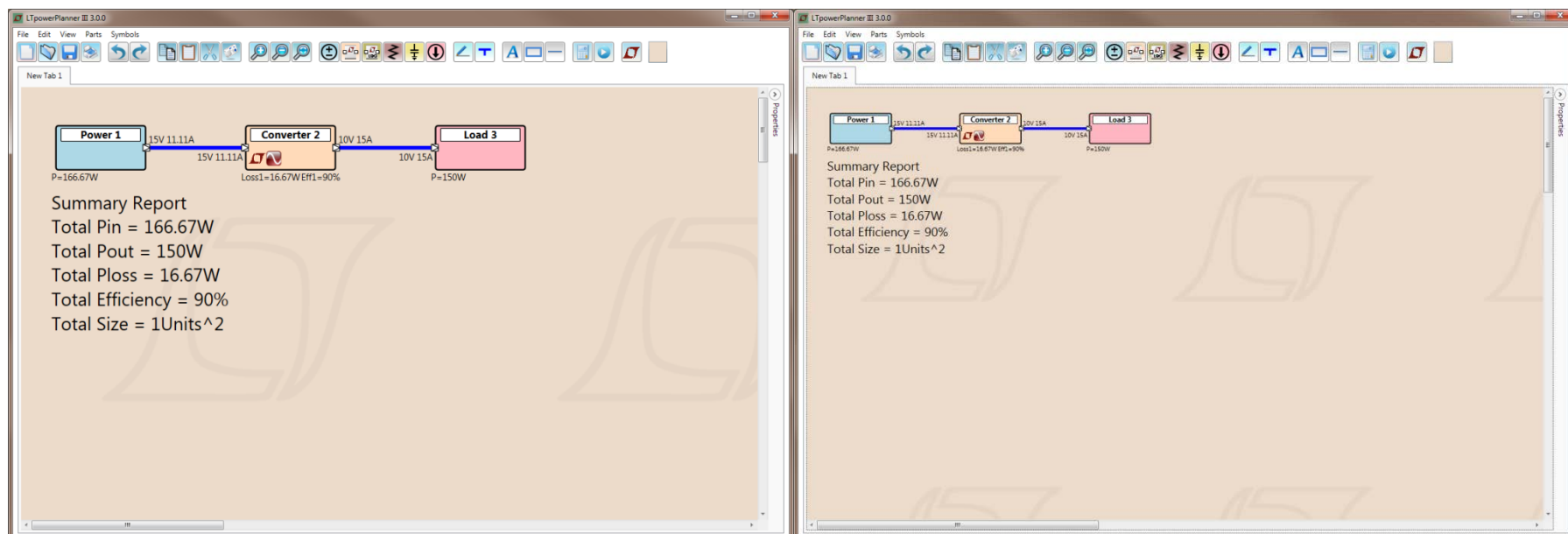

Design Example – Functions & Features(3)

Delete. Click the  icon to enter “Delete” Mode. **Deleting components** will automatically delete wires that are no longer relevant without the component. Right-click the Drawing Area to exit “Delete” mode.

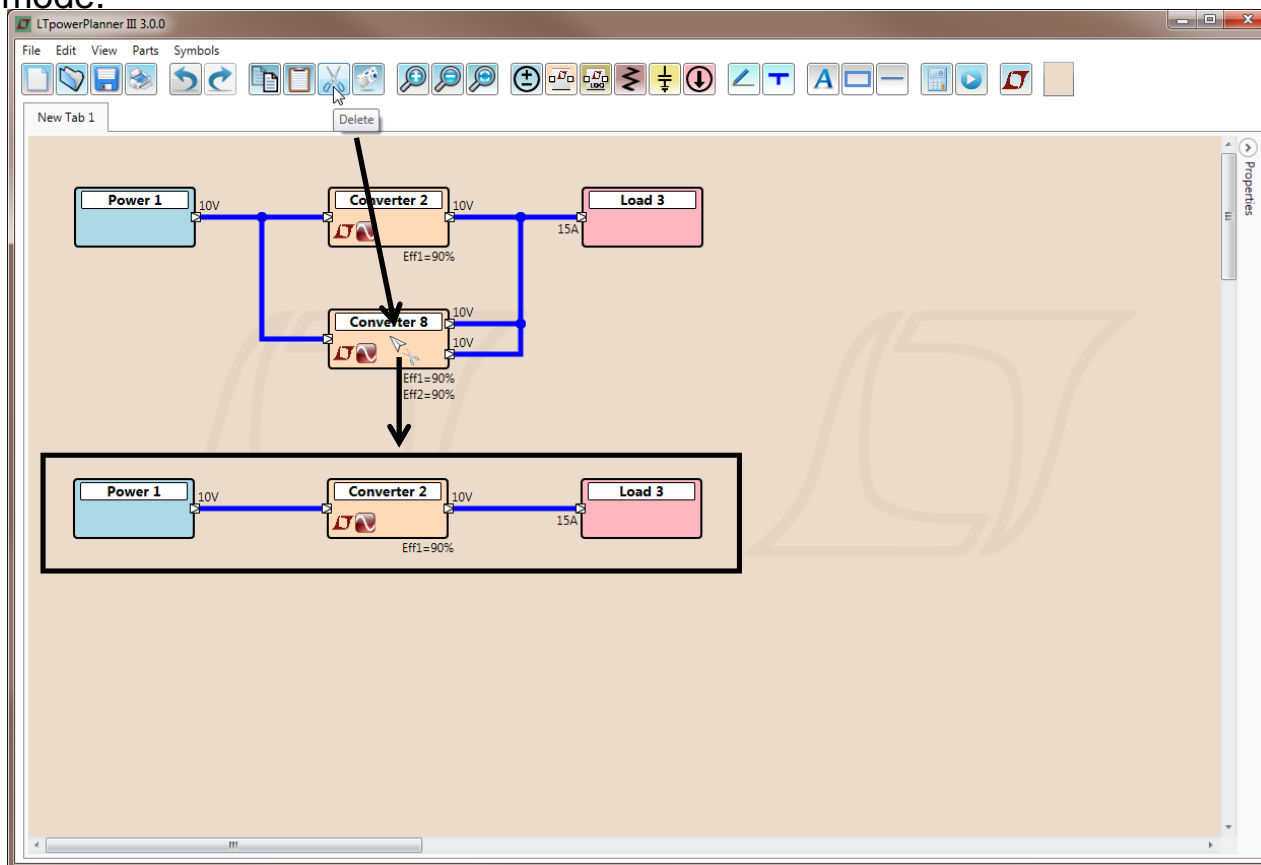

Design Example – Functions & Features(4)

Delete. Deleting a wire will automatically delete joining wires that are no longer relevant. Right-click the Drawing Area to exit “Delete” mode.

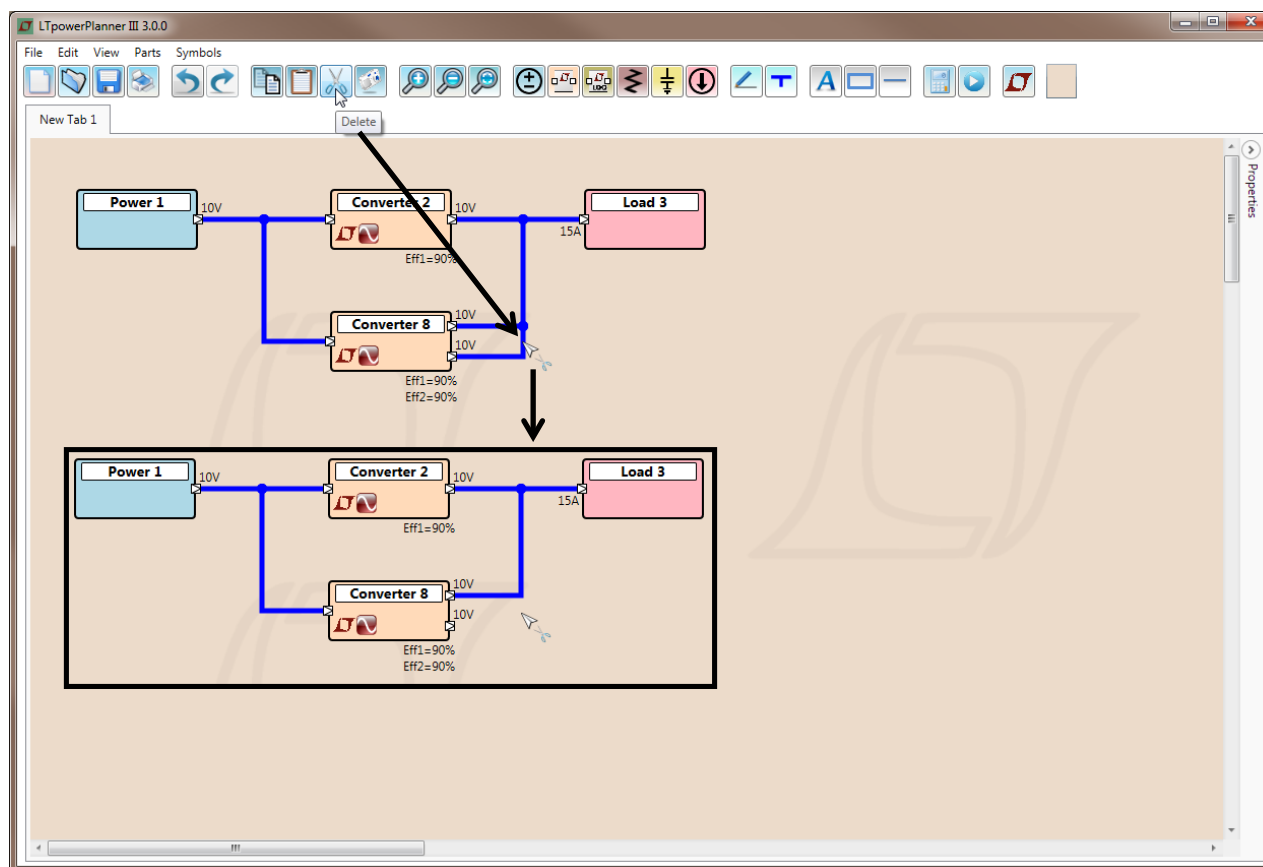

Advanced Functions – Drag Delete

Drag (Group) Delete. Delete groups of parts by dragging the Delete tool

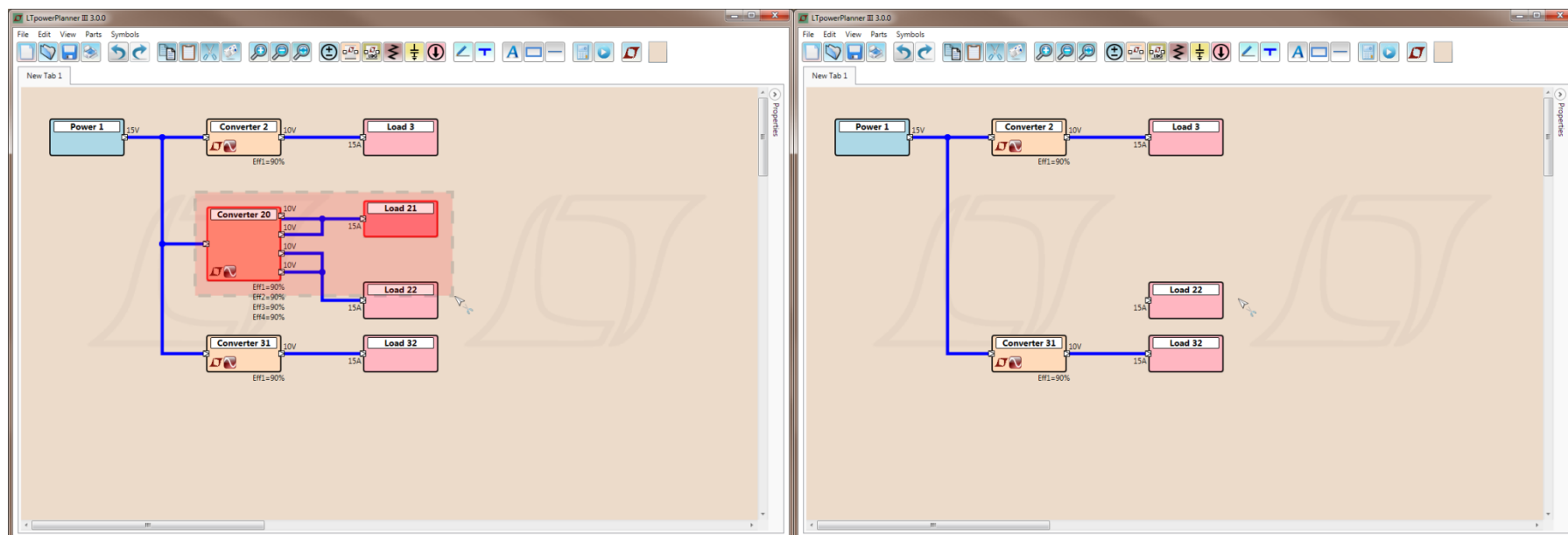

Design Example – Functions & Features(5)

Group Copy/Paste. Duplicates the selected components and their properties.

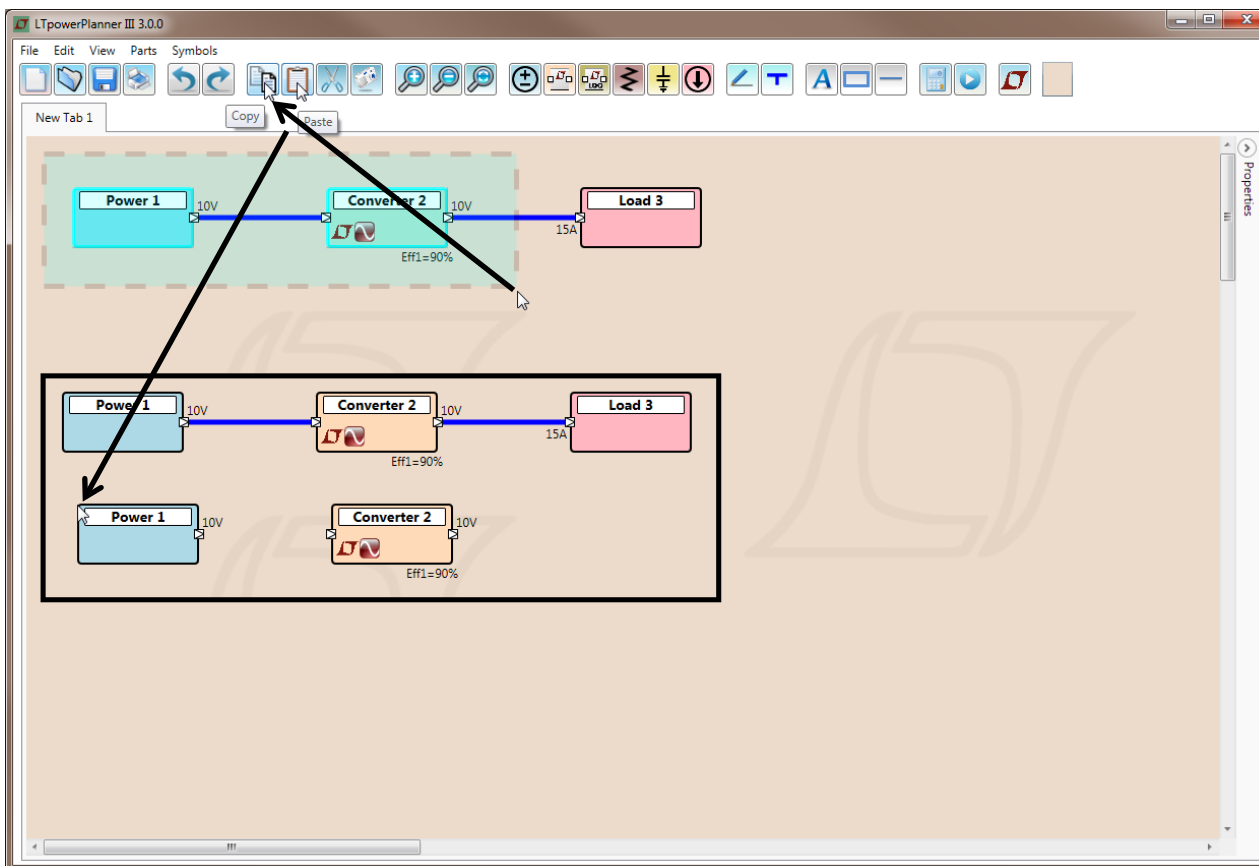

Note: copy/paste connection wires are not supported yet.

Design Example – Functions & Features(6)

Resize Component. Resize parts by dragging the corner of the part when the cursor changes to the resize icon. Rectangles, lines and text can be resized from multiple corners.

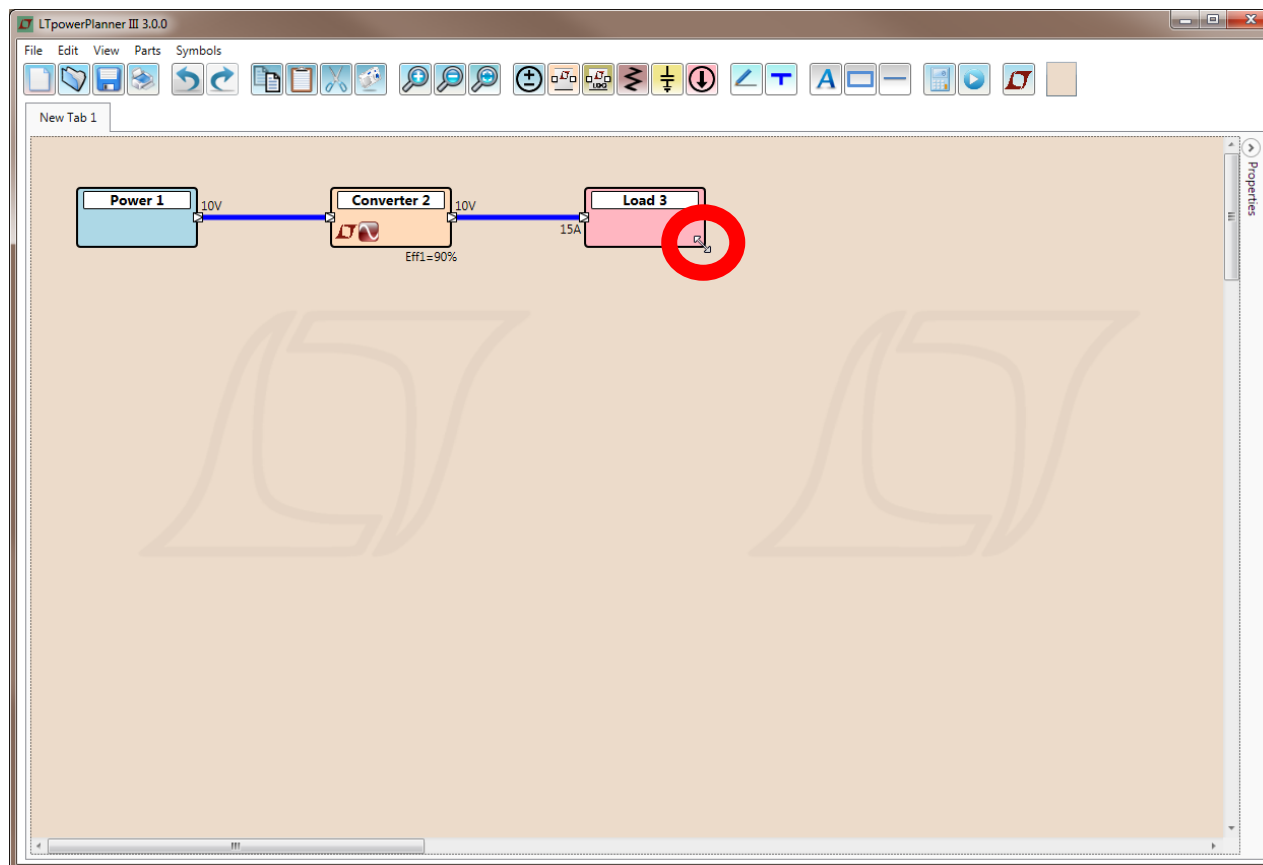

Design Example – Functions & Features(7)

Add Converter Output Terminals. Click the “+” button to add an output to the selected converter.

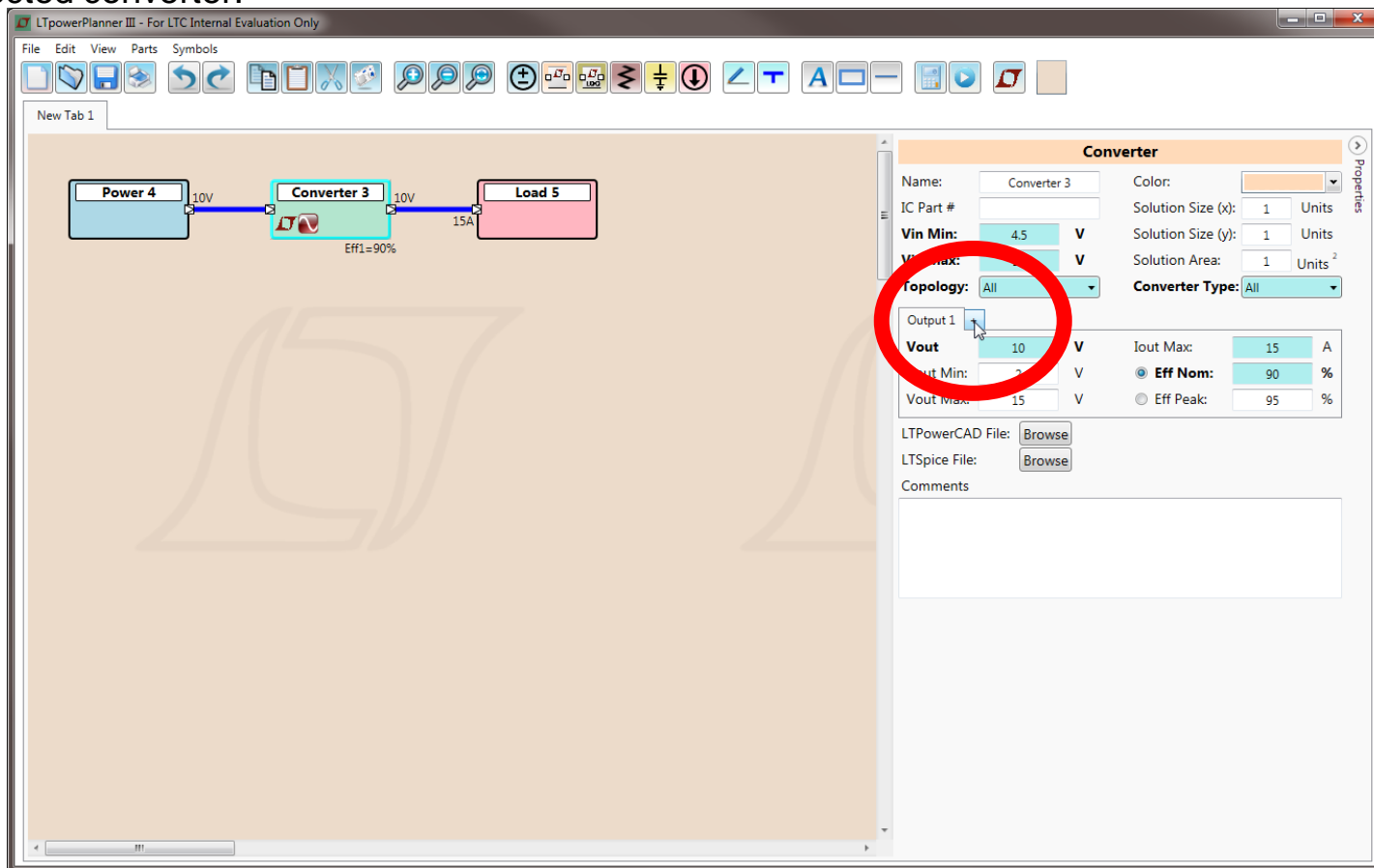

Design Example – Functions & Features(8)

Add Output Terminals. Each converter can have up to **8** outputs with separate efficiencies and output voltages.

The screenshot displays the LTpowerPlanner III software interface. The main workspace shows a schematic with a central green component labeled "Converter 3". To its left is a blue component labeled "Power 4" connected to the converter's input. To its right is a pink component labeled "Load 5" connected to one of the converter's outputs. The converter has eight output terminals, each labeled "10V". Below the converter, a list of efficiencies is shown: Eff1=90%, Eff2=90%, Eff3=90%, Eff4=90%, Eff5=90%, Eff6=90%, Eff7=90%, and Eff8=90%.

The right-hand side of the interface features a "Converter" properties panel. The "Name" is "Converter 3". The "Vin Min" is 4.5 V and "Vin Max" is 20 V. The "Topology" is set to "All" and the "Converter Type" is "All". The panel includes a table for output configurations:

Output 5	Output 6	Output 7	Output 8
Output 1	Output 2	Output 3	Output 4
Vout	10 V	Iout Max	15 A
Vout Min	2 V	Eff Nom	90 %
Vout Max	15 V	Eff Peak	95 %

Below the table, there are fields for "LTPowerCAD File:" and "LTSpice File:" with "Browse" buttons, and a "Comments" text area.

Design Example – Functions & Features(9)

Add Load Input Terminals. Add an unlimited amount of Terminals to Load Parts by clicking the “Add New Load Terminal” button.

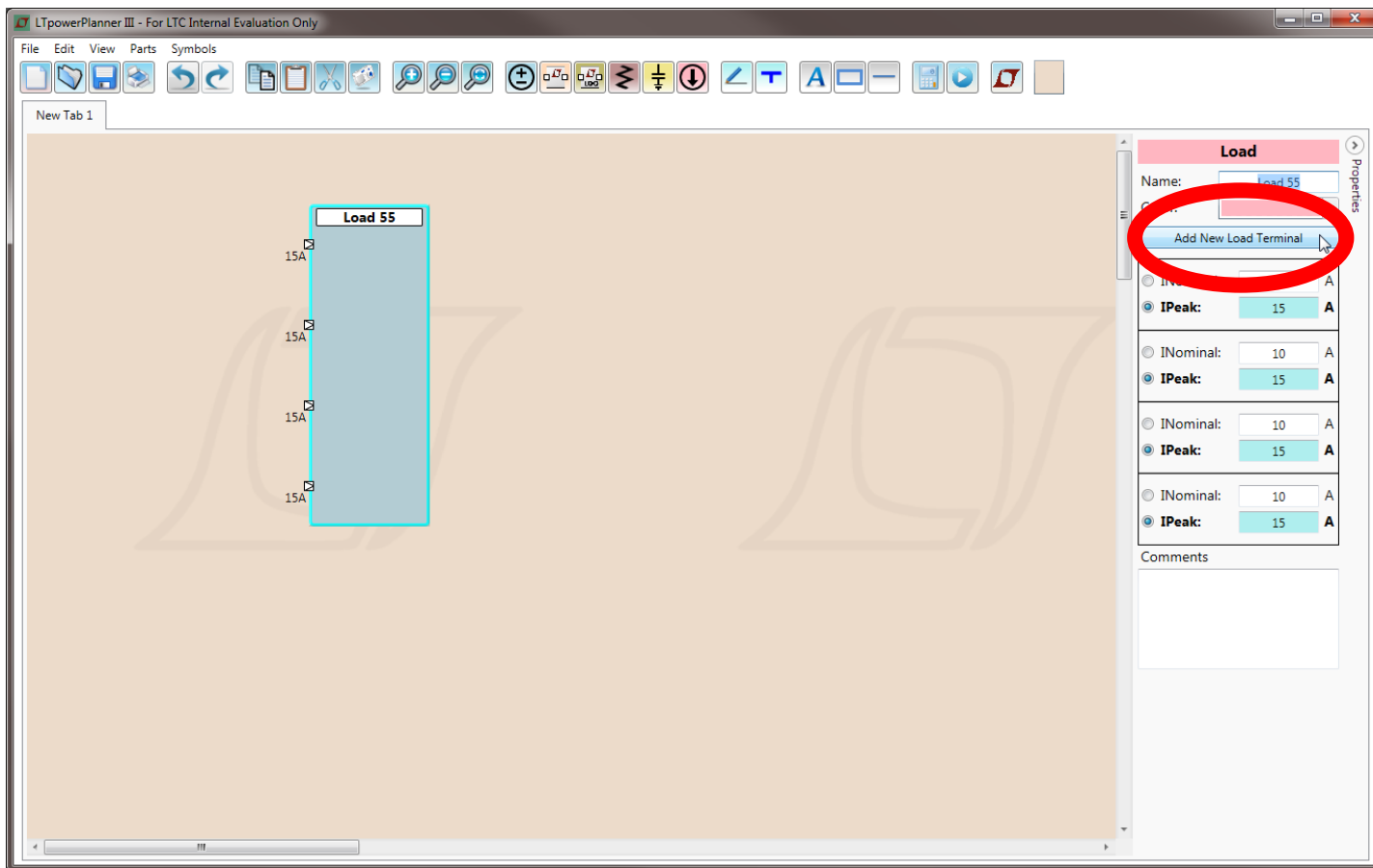

Design Example – Functions & Features(10)

Change Load Visual (Symbol). Change the appearance of Single Load Parts and Input Parts by clicking the “Change Visual” button.

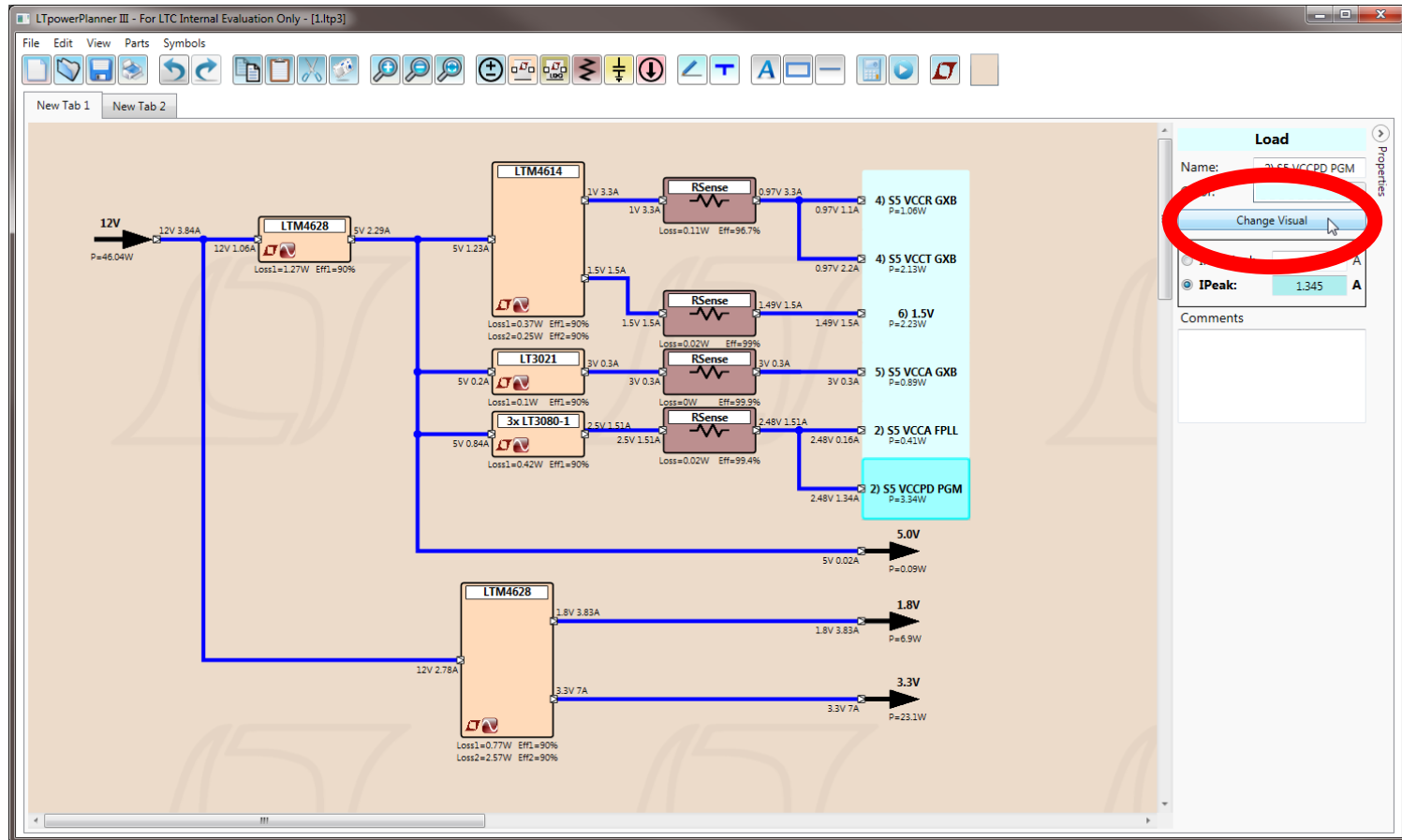

Design Example – Functions & Features(11)

Change Load Visual. Experiment with different sizes and configurations to achieve the desired appearance.

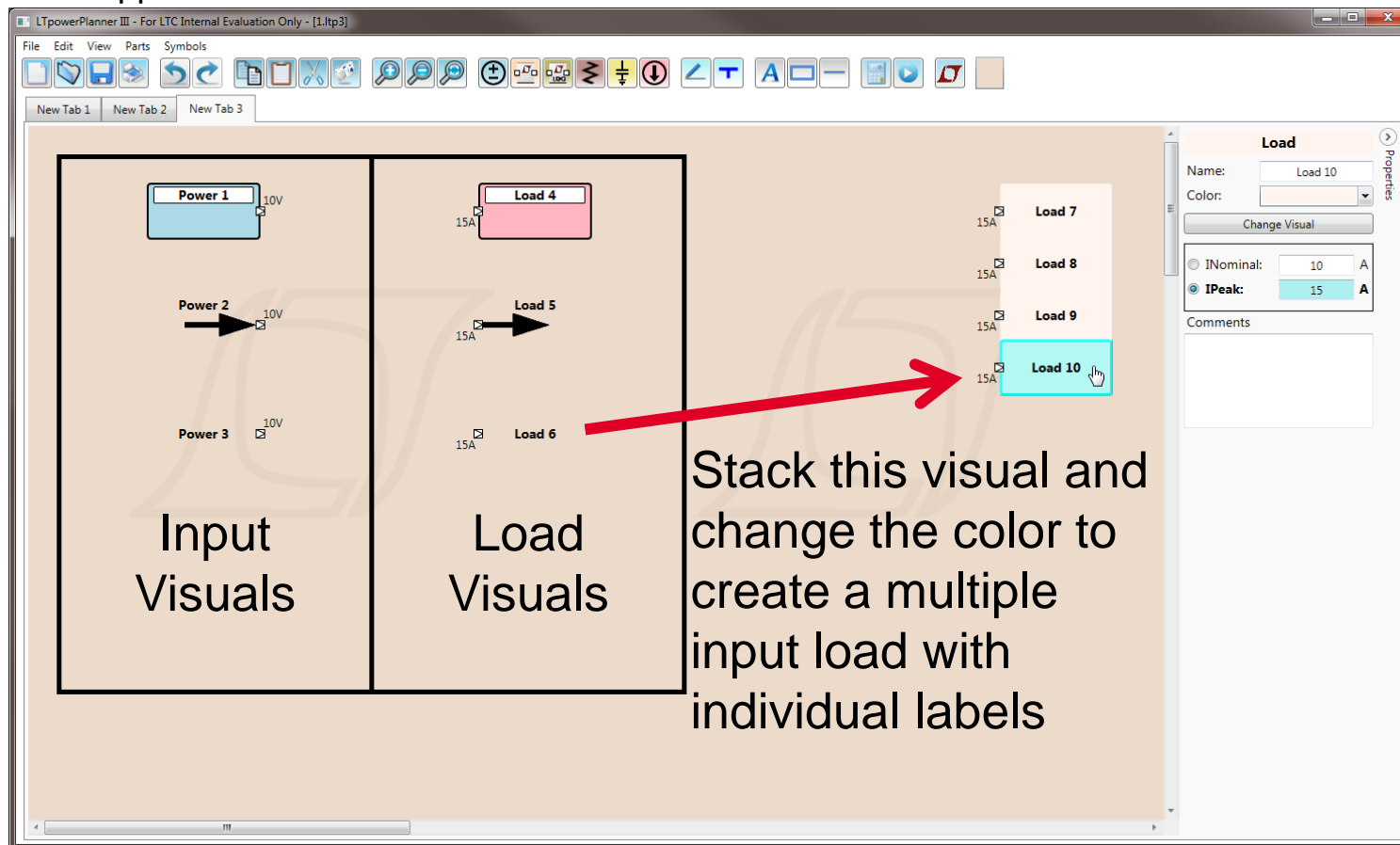

Design Example – Functions & Features(12)

Net Naming Part. Net naming parts with the same name are connected. This part cannot be connected by dropping onto existing wires. You have to manually connect wires to it to establish connections.

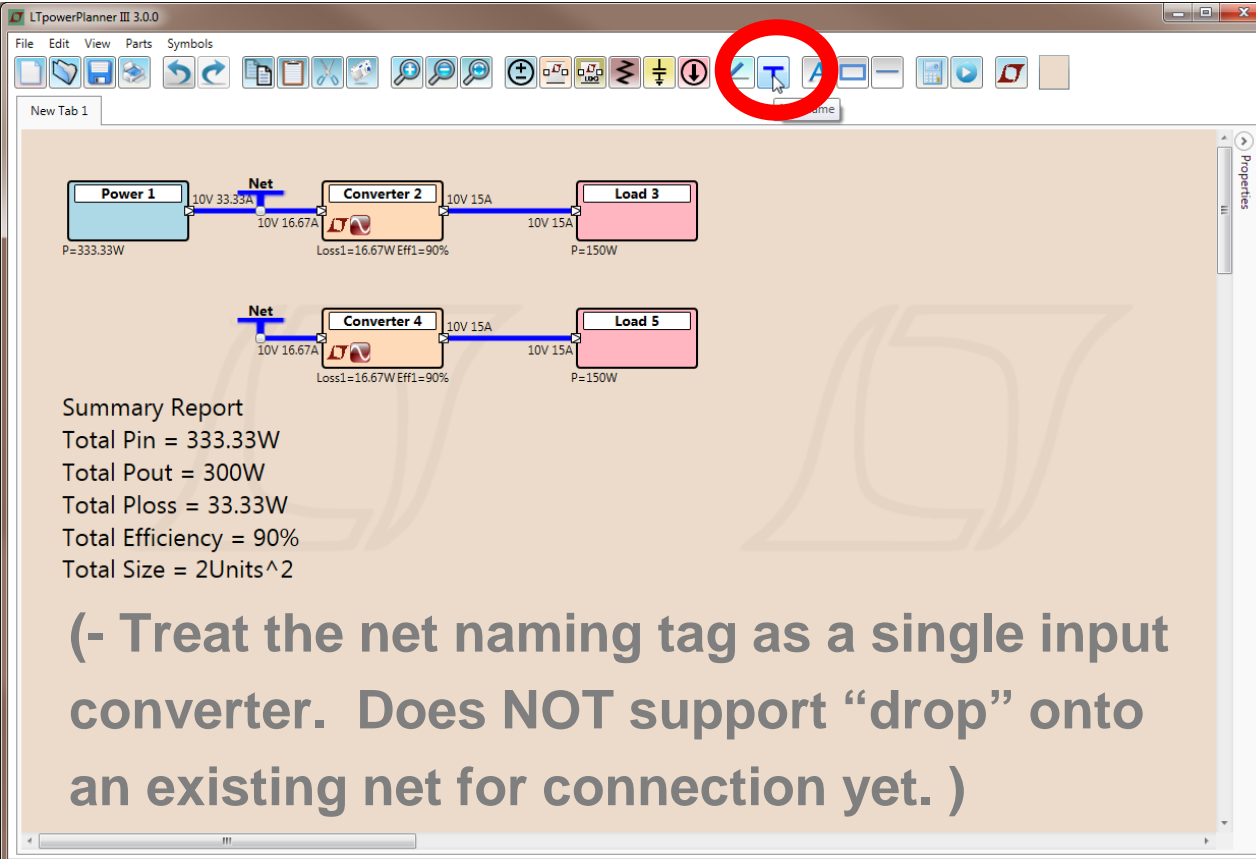

The screenshot shows the LTpowerPlanner III 3.0.0 software interface. The main workspace displays a circuit diagram with two power conversion stages. The top stage consists of a 'Power 1' block (P=333.33W) connected to a 'Net' block (10V 33.33A), which is then connected to 'Converter 2' (Loss1=16.67W Eff1=90%), and finally to 'Load 3' (P=150W). The bottom stage consists of a 'Net' block (10V 16.67A) connected to 'Converter 4' (Loss1=16.67W Eff1=90%), which is then connected to 'Load 5' (P=150W). A red circle highlights the 'Net Naming' tool in the toolbar. Below the diagram, a 'Summary Report' is displayed:

Summary Report
 Total Pin = 333.33W
 Total Pout = 300W
 Total Ploss = 33.33W
 Total Efficiency = 90%
 Total Size = 2Units^2

(- Treat the net naming tag as a single input converter. Does NOT support “drop” onto an existing net for connection yet.)

Design Example – Functions & Features(13)

Copy an area of the drawing to image. Click the “Camera” icon. Left click and drag the cursor until the area covers the image you want to copy. This highlighted area of the drawing has been copied to the clipboard which can now be pasted elsewhere as a picture/image.

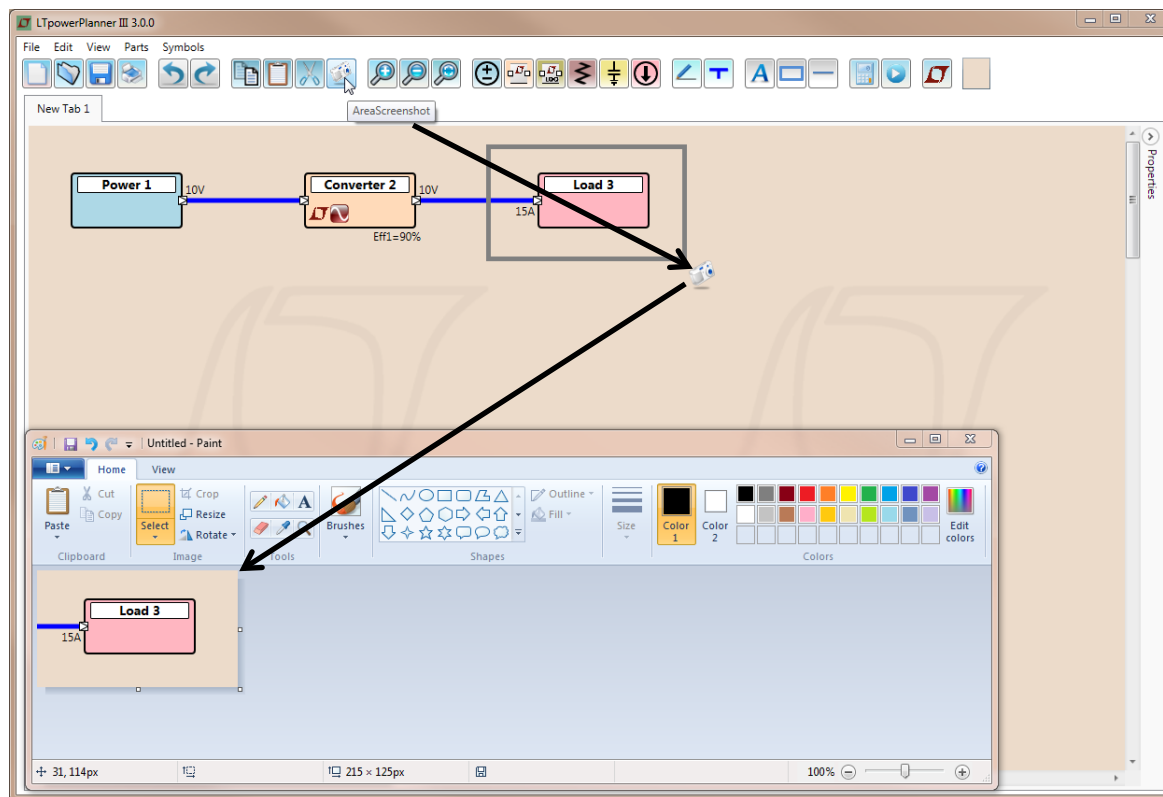

Design Example – Functions & Features(14)

Add text boxes and highlights. Icons from the Shapes group allow you to add commenting text and bring attention to specific areas.

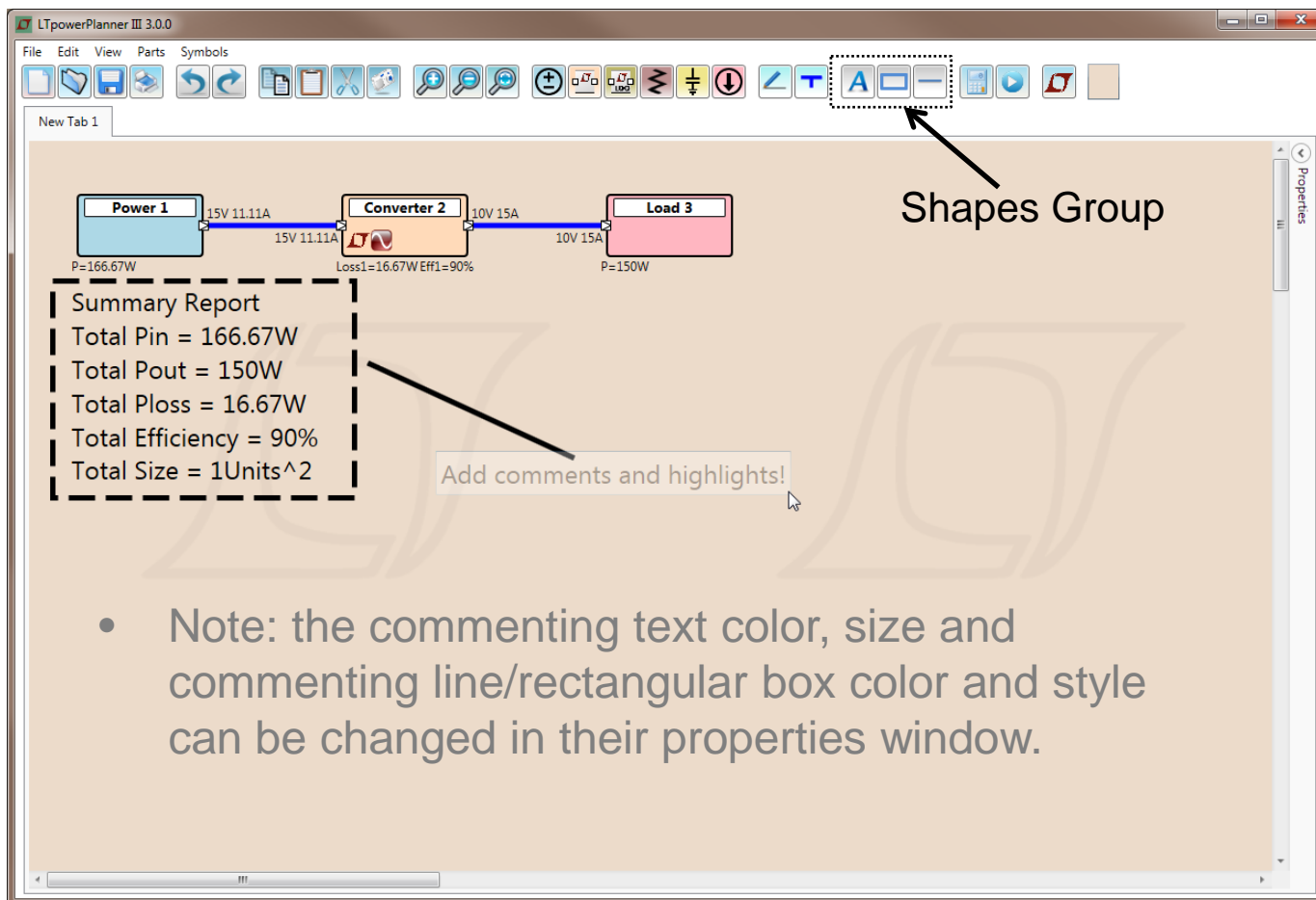

- Note: the commenting text color, size and commenting line/rectangular box color and style can be changed in their properties window.

Design Example – Functions & Features(15)

New Tab. Click the “Page” icon to create a new tab. Each tab is included under the same project. Save will save all tabs into one project file.

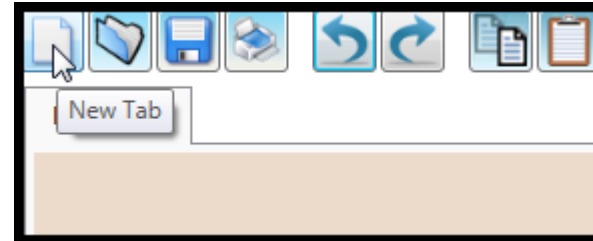

Rename Tab. Double click the Tab Name to rename the tab.

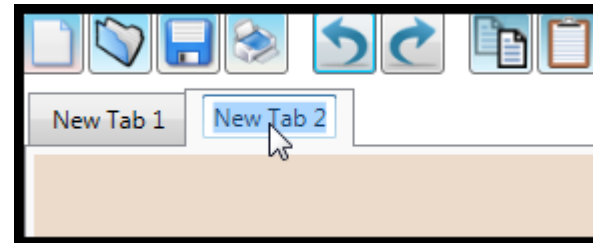

Delete Tab. Right click the Tab Name to bring up the delete option.



Design Example – Functions & Features(16)

Save/Open. “Save” and “Open” apply to ALL TABS! Each tab is designed to be a part of one solution. This means “Save” saves all your tabs to one file which has multiple tabs. When you “Open” a file, all your tabs will be replaced by the new project.

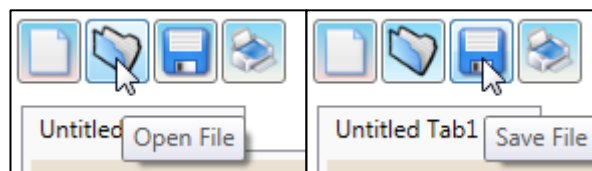

Print. Print will Zoom-to-Fit the current tab and open your printing options.

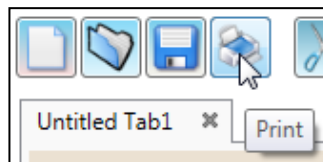

Undo/Redo.

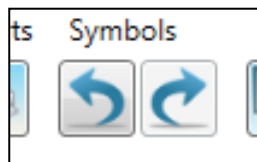

Design Example – Functions & Features(17)

Change Background Color. Click the “Color Switch” icon next to the “LTpowerCAD” icon. This will bring up a Color box that will let you change the color of the drawing area background.

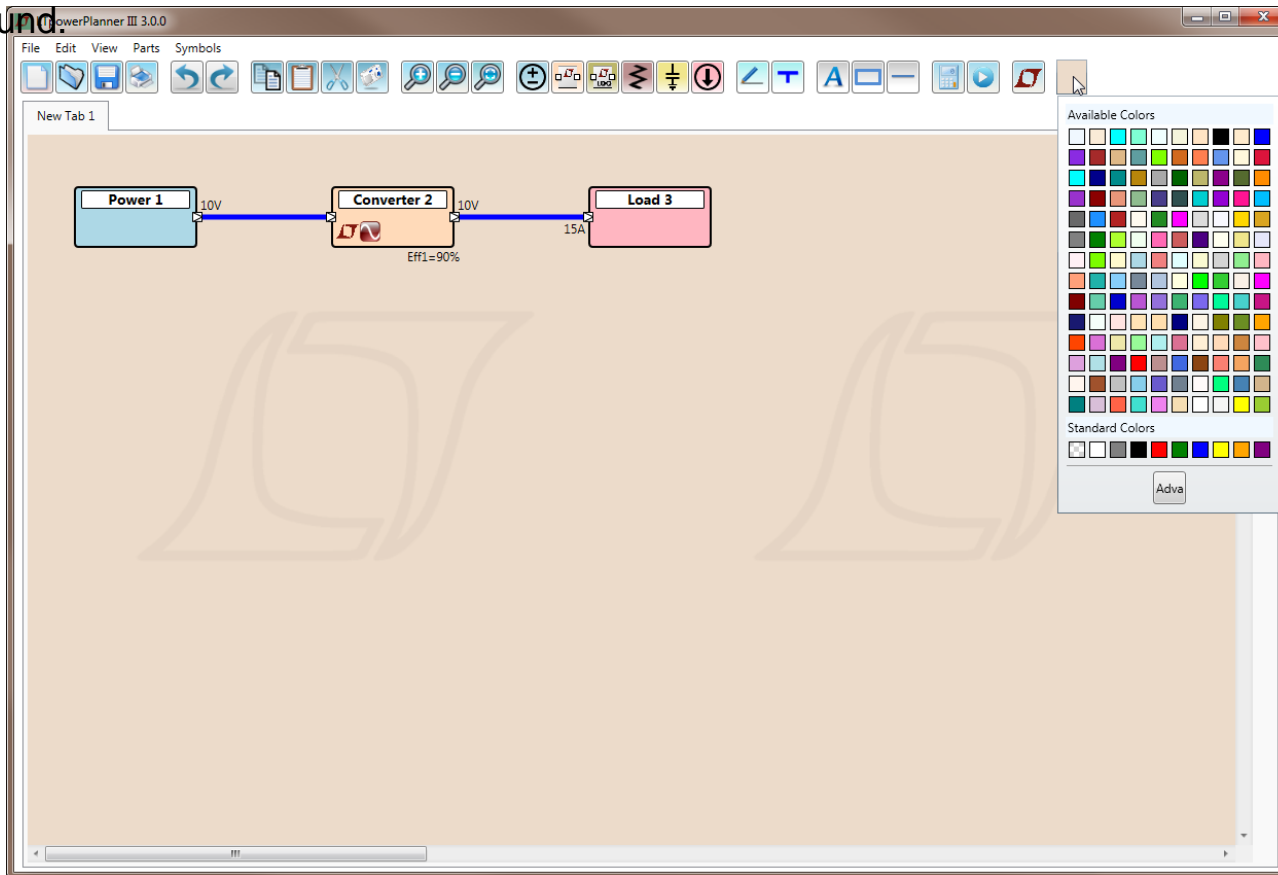

Design Example – Functions & Features(18)

Printing. Landscape printing is the default setting and can be changed in printing preferences.

The screenshot displays the LTpowerPlanner III interface. The main workspace shows two circuit diagrams. The top diagram consists of a Power source (Power 4) connected to a Converter (Converter 3), which is then connected to a Load (Load 5). The bottom diagram shows a similar setup with Converter 62 and Load 63. A Summary Report panel on the right provides the following data:

Summary Report	
Total Input Power:	333.33W
Total Output Power:	300W
Total Power Loss:	33.33W
Total Efficiency:	90%

Two dialog boxes are overlaid on the main window. The 'Print' dialog box is open, showing printer selection options and page range settings. The 'Printing Preferences' dialog box is also open, with the 'Paper/Quality' tab selected. In this dialog, the 'Orientation' dropdown menu is open, and 'Landscape' is highlighted with a red circle, indicating the default setting.

Functions – Link LTspice/LTpowerCAD Files

Link Files. Click “Browse” in a converter’s Property Window to link an existing **LTSpice** or **LTPowerCAD** design file (previously created by user in a PC folder) to a specific converter.

The image displays two side-by-side 'Converter' property windows and a schematic diagram. Both windows show the same configuration: Name: Converter 2, Color: (orange), IC Part #: (empty), Vin Min: 4.5 V, Vin Max: 20 V, Topology: All, Converter Type: All, Output 1: Vout 10 V, Vout Min: 2 V, Vout Max: 15 V, Iout Max: 15 A, Eff Nom: 90%, and Eff Peak: 95%. The left window has 'LTpowerCAD File' and 'LTSpice File' fields with 'Browse' buttons. The right window has 'LTpowerCAD File' set to 'ExampleLTPCFile.ltpc' and 'LTSpice File' with a 'Browse' button. The schematic on the right shows two 'Converter 2' blocks with 'Eff1=90%' and '10V' output, with arrows pointing from the 'Browse' buttons in the property windows to the converter symbols in the schematic.

Open Linked Design / Simulation files. Click the LTpowerCAD or LTSpice button to open the linked files.

Functions – Open LTpowerCAD Parametric Search

Parametric Search. Clicking the LTpowerCAD button **without** a linked file will open LTpowerCAD's parametric search using parameters pulled from the LTpowerPlanner converter. Clicking LTspice without a linked file will open a new LTspice window.

The image shows the LTpowerCAD II V2.4.3 interface. On the left, a schematic of a converter is shown with a callout box containing the following parameters:

- Name: Converter 2
- Color: [Orange]
- IC Part #: [Empty]
- Vin Min: 4.5 V
- Vin Max: 20 V
- Topology: All
- Converter Type: All
- Output 1: Vout 10 V, Iout Max: 15 A
- Eff Nom: 90%
- Eff Peak: 95%
- LTPowerCAD File: [Browse]
- LTSpice File: [Browse]
- Comments: [Empty]

The main window displays the LTpowerCAD Design Tool v2.4.3 interface. The Converter Specification section shows:

- Converter Topology: BuckBoost
- Converter Type: All
- Output Rail 1: Vout1 10 V, Iout1 15 A
- Min. Input Voltage: 4.5 V
- Nom. Input Voltage: 12.25 V
- Max. Input Voltage: 20 V
- Num. of Output Rails: One
- Num. of Parallel Phases: 1
- Find part #: (####) [Go]

The Optional Features section includes:

- Burst Mode
- Synchronous FET
- Isolated
- Run / Enable
- Sync. to External Clock
- Output Voltage Tracking
- Remote Voltage Sensing
- Margin Control
- Power Good Monitor
- Poly-phase / Load Share
- I2C/PMBus Interface

The Search section includes buttons for Search Parts, All Parts, and LTC Web Search, along with checkboxes for Search Designer's Tools Only and Always Keep Search Page Open, and a Reset Search Filters button.

The Search For Parts table shows the following results:

Design Tool	Website	Part #	Type	Description	Topology	IC Max Vin	IC Min Vin
[LTspice]	[Empty]	[Empty]	[Empty]	[Empty]	[Empty]	[Empty]	[Empty]
[LTspice]	[Empty]	[Empty]	[Empty]	[Empty]	[Empty]	[Empty]	[Empty]
[LTspice]	LTC Web	LTC3780	Controller	High Efficiency, Synchronous, 4-Switch Buck-Boost Con	Buck-Boost	36	4
[LTspice]	LTC Web	LTC3789	Controller	High Efficiency, Synchronous, 4-Switch Buck-Boost Con	Buck-Boost	38	4

At the bottom of the window, a note states: "LTpowerCAD currently supports design tools for a limited number of parts. For more part options click the LTC Web Search button."

Advanced Functions – Wire Snapping

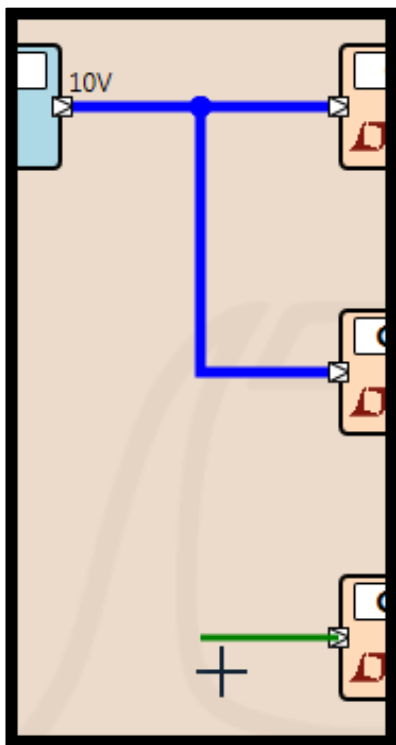

Snaps left of cursor location
to line up with the corner

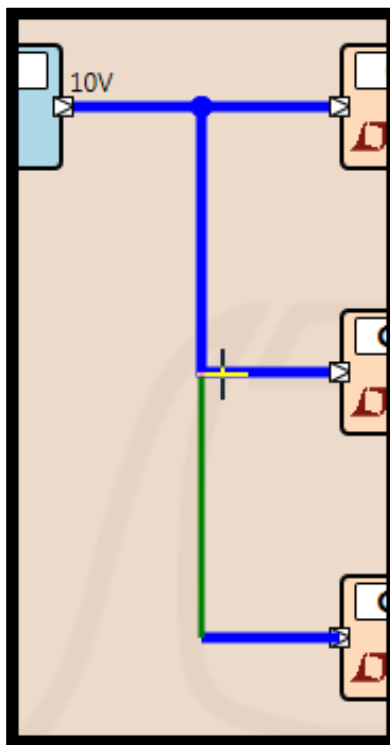

Must click wire to make
connection, even though it
snaps to the correct place

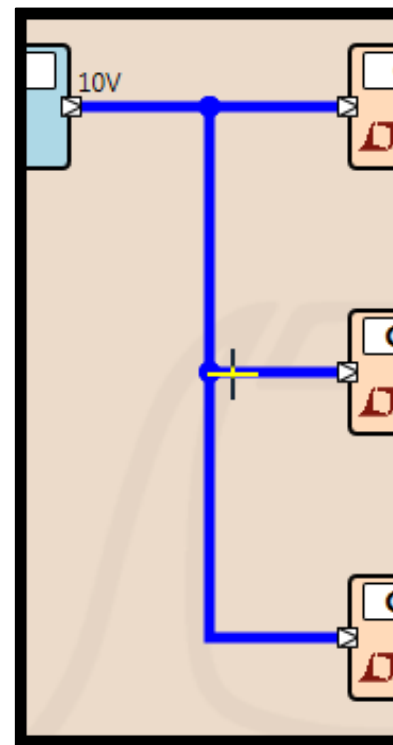

Easy clean connection

Drawing wires will snap to corners for easier and cleaner connections

Advanced Functions – Keybindings & Shortcuts

- ◆ Ctrl + N = New Tab
- ◆ Ctrl + O = Open File
- ◆ Ctrl + S = Save File
- ◆ Ctrl + Shift + S = Save File As
- ◆ Ctrl + P = Print

- ◆ Delete = Delete Mode
- ◆ Ctrl + C = Copy/Paste Mode
- ◆ W = Wiring Mode
- ◆ B = Run Calculation

- ◆ I = Draw Line
- ◆ A = Draw Arrow
- ◆ E = Draw Rectangle
- ◆ T = Text

- ◆ Space = Open/Close Properties Tab
- ◆ P = Create Power
- ◆ S = Create Single Converter
- ◆ D = Create Dual Converter
- ◆ R = Create Resistor
- ◆ O = Create LDO Converter
- ◆ C = Create Capacitor
- ◆ L = Create Load

- ◆ - or Ctrl + Scroll Down = Zoom Out
- ◆ = or Ctrl + Scroll Up = Zoom In
- ◆ 0 = Zoom Fit
- ◆ Scroll = Vertical Scroll
- ◆ Shift + Scroll = Horizontal Scroll

Backward Compatibility with LTpowerPlanner Rev.2.

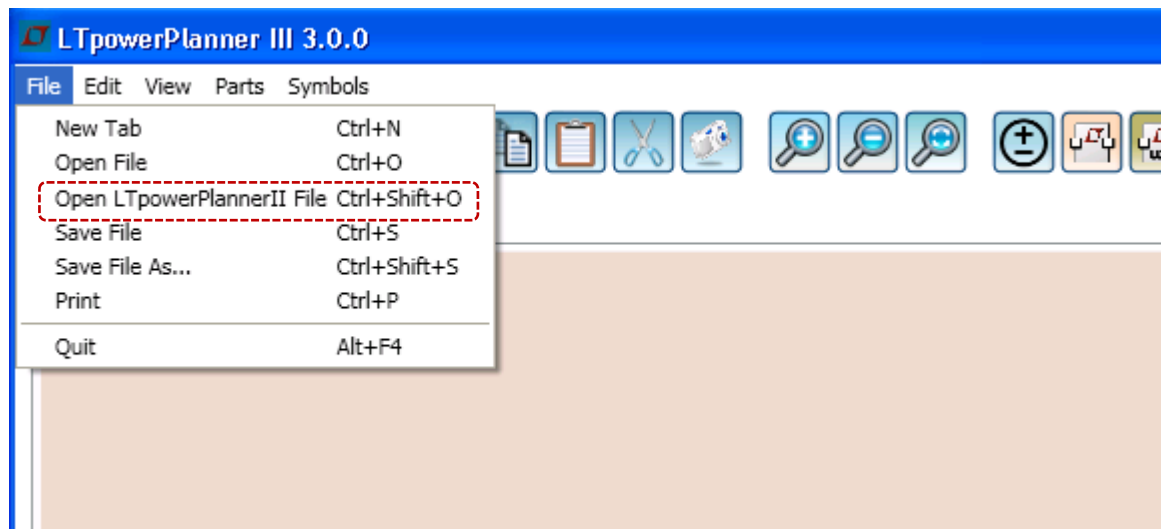

- Due to the major program structure change, the LTpowerPlanner III can open the LTpowerPlanner II project files. Only the components are imported. The wiring connection is not imported.
- We will keep the backward compatibility for future LTpowerPlanner III and beyond program versions.

Future Functions – In Development

In Development:

- **Delete Extra Input/Output Terminals**
- **Group Copy/Paste with Wiring**
- **Support Negative Output Voltage**
- **Support Multiple Output LDO**

Thank You

Now you have gone through the main features of the program and are ready to use LTpowerPlanner™ !

There are still more features to explore...

Questions? Suggestions?
Email to: LTpowerCAD@linear.com